

**Prediction Manual for  
Drainage Chemistry  
from Sulphidic Geologic  
Materials**

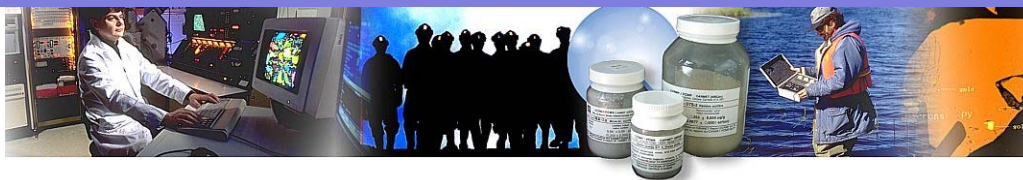
**MEND Report 1.20.1**

**This work was done on behalf of MEND and sponsored by:  
The Mining Association of Canada (MAC)  
Natural Resources Canada (NRCan)  
British Columbia Ministry of Energy, Mines and Petroleum Resources/  
British Columbia Technical Research Committee on Reclamation  
International Network for Acid Prevention (INAP)  
Ontario Ministry of Northern Development, Mines and Forestry and  
Yukon Mining and Petroleum Environment Research Group**

**December 2009**



# CANMET Mining and Mineral Sciences Laboratories



## **Prediction Manual for Drainage Chemistry from Sulphidic Geologic Materials**

**Report prepared by:**

**William A. Price**

**CANMET- Mining and Mineral Sciences Laboratories**

**Smithers, British Columbia**

**V0J 2N0**

**Work performed for:**

**MEND Program**



## PREAMBLE

Prediction of drainage chemistry is a technical subject, involving a large number of methods, properties and processes. The objective of this Manual is to provide the comprehensive, in-depth level of understanding needed to conduct a prediction program and then review the results. Consequently, this document is long and detailed with some repetition of overarching information.

Readers will come from many different backgrounds. Some will be experts in the physical, chemical or biological sciences; others will be engineers, geologists or soil scientists and some will be non-technical people who want to understand more about mine site drainage. The objective is to provide the general overviews and in-depth technical explanations needed by experts and non-experts, alike.

Ways to navigate through the manual to find information on specific aspects of prediction are described on the next page.

The information provided here is based on the opinions of the author and should not be construed as endorsement in whole or in part by the various reviewers or by the partners in MEND (the Government of Canada, Provincial Governments, The Mining Association of Canada, contributing mining companies and participating non-governmental organizations). The user of this guide should assume full responsibility for prediction and mitigation of future drainage chemistry from sulphidic geologic materials (metal leaching and acid rock drainage) and for any action taken as a result of the information contained in this guide.

Natural Resources Canada is committed to improving existing practices. Comments on or suggested improvements to this document are welcome and should be submitted to the author at [bprice@nrcan.gc.ca](mailto:bprice@nrcan.gc.ca) or at the following address:

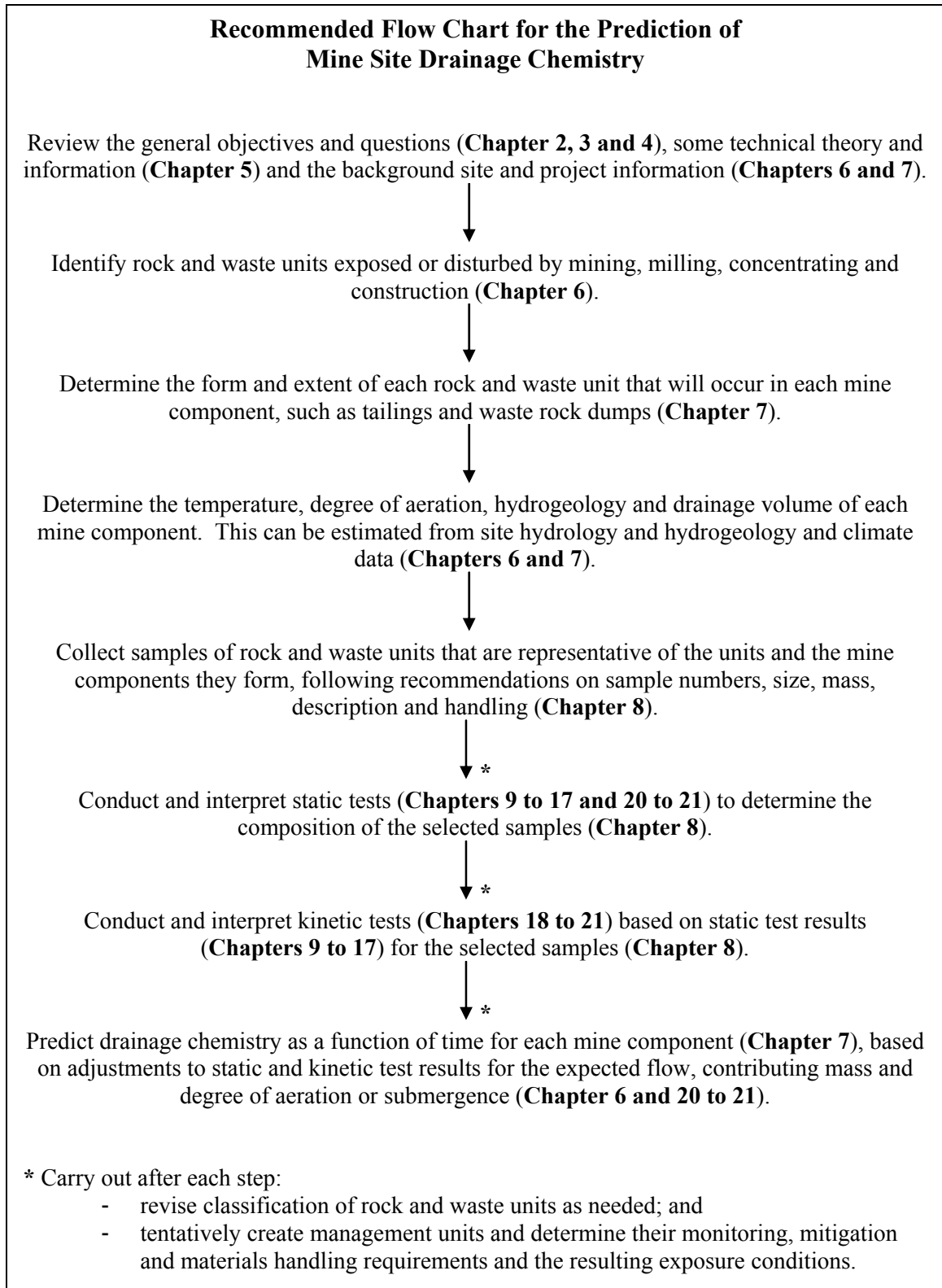
CANMET- Mining and Mineral Sciences Laboratories  
Natural Resources Canada  
Bag 5000  
3793 Alfred Avenue  
Smithers, British Columbia  
Canada V0J 2N0

## NAVIGATING THIS MANUAL

This Manual is supplemented by many guides to aid in navigating such a comprehensive document.

- Page (PA-3) is a graphical flowchart showing how the chapters are linked in groups and sequences for the prediction of drainage chemistry from sulphidic geologic materials.
- Then, several pages contain summaries discussing some of the major points in each chapter.
- Next, the Table of Contents, beginning on page (PA-26), shows how this Manual is divided into major topics by chapters, sections and sub-sections.
- The List of Tables and the List of Figures, on pages (PA-39 to PA-44), highlight the various tables and lists found throughout.
- Each chapter begins with a text box, highlighting the major points found in that chapter. Several smaller boxes are sprinkled throughout the document, bringing attention to useful facts and important details.
- And after Chapter 21, the Glossary defines many of the technical terms and acronyms found in the Manual.

## FLOWCHART OF CHAPTERS



## SUMMARY OF SOME IMPORTANT POINTS IN EACH CHAPTER

### Chapter 1: Introduction

Drainage waters from sulphidic geologic materials can contain elevated concentrations of metals and other elements at any pH. This may lead to costly environmental management and remediation. Successful, cost-effective, proactive mitigation measures depend on an accurate prediction of future drainage chemistry. The prediction of drainage chemistry from sulphidic geologic materials is therefore important in ensuring that the extraction of Canada's mineral resources occurs in a sound fiscal manner and minimizes impacts to adjacent land and watercourses.

Guidance is provided on the strengths and potential limitations of different procedures, analyses, tests and criteria used to predict future drainage chemistry. This Manual recommends site specific prediction of drainage chemistry. Users of the Manual should consider local site conditions, such as the weathering environment, the stage of project development, geologic materials, mine components, environmental goals and project needs when deciding which of the procedures in this Manual to use and how to interpret the results. The document is not intended to limit the properly supported approaches or substitute for individuals with the appropriate technical training and experience.

### Chapter 2: Overall Objectives of Prediction

The objective in predicting drainage chemistry is to determine the type, magnitude, location and timing of measures required to prevent significant environmental impacts. These objectives are achieved by: measuring the present drainage chemistry; predicting the potential future drainage chemistry; determining the influential properties and processes and predicting the timing of significant changes in the drainage chemistry and influential properties and processes. Predictions should be made for all excavated, exposed and otherwise disturbed sulphidic geologic materials.

Our understanding of the properties and processes determining drainage chemistry is far from complete. However, the available prediction tools combined with a comprehensive, well-informed approach and cautious interpretation of the results should allow mines with sulphidic geologic materials to meet receiving environment objectives and minimize the liability and risk. The predicted drainage chemistry will often be a range in contaminant concentrations because of the range of properties within each geologic and waste management unit and the limited accuracy and precision of the prediction methods. Uncertainty regarding drainage chemistry should be reduced to the level at which plans that will meet the environmental objectives can be designed and implemented.

### Chapter 3: General Principles and Best Practices

The "best practice" for drainage chemistry prediction is to take a site specific and proactive approach. Drainage chemistry should be predicted for all geologic materials in the forms that will be excavated, exposed or otherwise disturbed (the resulting project components). Prediction



should consider the spatial variability and temporal changes in the contributing properties and processes and use an iterative, phased and scientific approach. Due to the large number of factors involved, proper planning is an essential component of successful prediction. Prediction should occur throughout the life of the project. The objective at each stage is to demonstrate that the project has the necessary understanding, capability, resources and intent to protect the environment. Challenges in prediction include dealing with uncertainty and changes in mine plans. It is important to identify the materials and methods and intended uses for prediction work, use clearly defined terminology and consider the cost-effectiveness prior to initiating each phase of test work. Prediction requires qualified personnel and adequate resources. Maintaining prediction information in an accessible form that facilitates regular review and tracking of changes is also extremely important. Practitioners should be aware of past errors in prediction, act safely and recognize that a proper understanding can only be achieved by reviewing the details regarding site conditions, sampling, sample preparation, analyses, test procedures and the interpretation of data.

#### **Chapter 4: Main Steps and Stages of a Prediction Program**

There are three main steps for predicting drainage chemistry. First, the general properties of the project and site should be reviewed. Second, any existing drainage chemistry should be measured and monitored, then potential future drainage chemistry predicted. Third, predictions made from the previous steps should be periodically checked and updated, with any significant information gaps identified and highlighted. The third step should be conducted repeatedly through all stages of a project.

#### **Chapter 5: Parameters and Processes Controlling Drainage Chemistry**

There are a large number of parameters and processes that affect site specific drainage chemistry from sulphidic geologic materials. This chapter discusses the more important ones from a geochemical perspective.

#### **Chapter 6: Site Conditions**

Because prediction of drainage chemistry requires a great deal of site specific information, this chapter lists and discusses many important aspects of site conditions. Local and regional geography, climate, hydrology, and hydrogeology should be defined. Since drainage chemistry will likely change with mining, detailed investigations of geological issues are also needed, including spatial variations in soils, overburden and rock units. Other important aspects of site conditions are the requirements and expectations of the local community, regulators, company, and other stakeholders.

#### **Chapter 7: The Project and Project Components**

Each project and site can be divided into components, such as open pits, underground workings, waste rock dumps, low grade ore stockpiles, tailings impoundments and borrow materials. Drainage predictions can then be developed for each component, based on its unique combination of site conditions and design. These predictions require site specific information on

a myriad of combinations of physical, geochemical, biological and engineering properties and processes. This chapter lists and discusses many of these properties and processes, including how they may change through time. For example, initial drainage chemistry from an open pit may reflect weathering of the mine walls, but later chemistry may reflect the ongoing accumulation of finer grained talus with greater reactive surface area. Also, rising or falling water tables can greatly change the rate of sulphide oxidation while inversely affecting the loadings in drainage.

### **Chapter 8: Selection, Storage and Preparation of Samples**

The selection, storage, and preparation of samples are critical steps in the prediction of drainage chemistry from sulphidic geologic materials. If a sample is not selected and stored properly, all the remaining time and cost spent on analyses and interpretations could be wasted. Careful decisions must be made on many issues, such as which material to sample, the method and frequency of sampling, the appropriate volume of the sample, whether to crush or grind the sample, substitution of samples from other sources and separation of coarser less reactive particles from finer more reactive ones. Each sample should be described in detail and preferably geo-referenced to a location and depth at the mine or project. For example, samples of blast hole cuttings are often geo-referenced and placed in site geologic models. Characteristics like colour may provide some indication of weathering, leaching and oxidation to guide sampling, but colour is not always reliable.

### **Chapter 9: Overview of Static and Kinetic Tests**

The analyses and tests for predicting drainage chemistry can be divided into one time “static” and repetitive “kinetic” tests. There are many types of static tests, such as Acid Base Accounting (ABA) and total elemental analyses; these can be completed relatively fast. Kinetic tests, including laboratory based humidity cells and on-site leach pads, can take years to complete and are more expensive. For these reasons, kinetic testing is often limited to samples identified as important and representative by static tests. Also, some kinetic tests provide primary mineral reaction rates, while others provide direct predictions of drainage chemistry after additional processes. Therefore, the objectives of all testing should be carefully considered and stated. Flow rates should always be measured in all kinetic tests to assist in interpretations. Many static and kinetic tests provide some information that is similar and complementary to others, so any discrepancies should be investigated and resolved. Test results should be carefully tabulated, accompanied by descriptive statistics, and also shown on scatterplots.

### **Chapter 10: Whole-Rock and Near-Total Solid Phase Elemental Analysis**

The analyses discussed in this chapter provides the total or near-total amounts of selected chemical elements in a solid phase sample. This is accomplished in two major steps. First, most or all of a sample is digested in a hot chemical flux or strong acid combination. Second, the digested sample is analyzed by one of several techniques, such as X-ray Fluorescence (XRF) or Inductively Coupled Plasma (ICP). It is important to be aware of the strengths and weaknesses of each method of digestion and analysis because it may affect predictions of drainage chemistry from sulphidic materials. For example, whole-rock analyses may be reported as oxide

equivalents, such as CaO and Al<sub>2</sub>O<sub>3</sub>, which require mathematical conversions to obtain pure element concentrations. These analyses do not reveal the forms in which an element occurs, such as in one or more minerals, although this can sometimes be estimated using a few assumptions. Also, solid phase levels, whether high or low are not on their own measures of the potential aqueous concentrations in drainage or of the threat to the environment. However, tests in other chapters are combined with these solid phase results for drainage predictions, such as the length of time until elements are fully leached from a sample.

### **Chapter 11: Analysis of Soluble Constituents**

Sulphidic geologic materials are often comprised of suites of minerals whose solubilities range from relatively low to high. The more soluble minerals can often dissolve faster and thus determine immediate drainage chemistry. However, the chemistry of the local water, the contact (residence) time and the water:solid ratio can also affect the dissolution of soluble constituents. The recommended procedure for measuring soluble constituents is to add the sample to shake flasks, with a default ratio of 3 parts solid to 1 part water on a weight basis and gently agitate it for 24 hours. These test conditions can be changed as needed to address site specific predictions questions. Attaining equilibrium, including mineral solubility limits, is important because net dissolution stops and aqueous concentrations do not rise any higher. Therefore, an important aspect in testing for soluble constituents is identifying when equilibrium has been reached. As a check for whether equilibrium limits have been attained, a sample can be leached a second time with fresh leach water or at different water to solids ratios. As a check for whether residence time has affected the results, leaching of the solid residue can be extended or repeated for a longer time. The measurements of surface (rinse), crushed and paste (pulverized) pH also reflect soluble constituents of samples.

### **Chapter 12: Sulphur Species and Acid Generation Potential (AP)**

Sulphur species are the primary source of potentially deleterious acid, acidity and elemental species in the drainage from sulphidic geologic materials. Their effects on drainage chemistry depend on factors like abundance, oxidation state, impurities, physical properties and local environmental conditions. The main sulphur minerals and species are sulphides, sulphosalts, sulphates, organic sulphur and species of intermediate oxidation states. Sulphide primarily occurs combined with iron in minerals such as pyrite, pyrrhotite, marcasite and monosulphides. In contrast, sulphate minerals can be grouped as highly soluble basic or acidic, moderately soluble basic, low solubility acidic and extremely insoluble.

The objective in sulphur analysis is to identify and measure the concentration and composition of different sulphur species with sufficient accuracy and precision. This is important for the calculation of acid generation potential (AP) and the prediction of elemental release under potential weathering conditions. There are several methods for measuring sulphur species discussed in this chapter. For example, Leco is a manufacturer of high temperature induction furnaces, whose name has become synonymous with the most common method for determining total carbon and sulphur. All methods have strengths and weaknesses, which should be understood for proper predictions from analytical data.

**Chapter 13: Acid Neutralization Potential (NP)**

The term acid neutralization potential (or NP) is presently used for a wide range of different laboratory measurements and field NP predictions. For sulphidic geologic materials, the primary concern is with the neutralization of acid potential from Chapter 12. Acidic drainage pH will result when the exposed acid neutralizing minerals are depleted or the rate of acid neutralization becomes inadequate.

To estimate “effective NP” under field conditions from laboratory analyses of NP, several properties and processes are important, including (1) identity, concentration and weathering mechanisms of minerals, (2) their contribution to the measured NP and (3) their cumulative rates of alkalinity production compared to the rate of acid generation under the site specific conditions for each project component. Some carbonate minerals provide a fast neutralization response and thus contribute more to effective NP than ferrous iron and manganese carbonates.

There are several methods for measuring NP, including the Carbonate, Sobek (U.S. EPA 600), several Modified, BC Research and Lapakko procedures. Each method has unique strengths and weaknesses, and thus no one method is the best for estimating effective NP. However, the comparison of Carbonate NP with one of the other “bulk-NP” methods assists in estimating the percentage of reactive carbonate contributing to bulk NP.

**Chapter 14: Acid Base Accounting and Criteria Used to Predict Potential for Acidic Drainage**

Acidic drainage will only result when the rate of acid generation exceeds the rate of acid neutralization. Acid Base Accounting (ABA) is a series of analyses and calculations used to estimate the potential for mineral weathering to produce acidic drainage. ABA includes rinse and paste pH (Chapter 11), sulphur species and acid potential (AP, Chapter 12), and acid neutralization potential (NP, Chapter 13). Mineralogy (Chapter 17), elemental analyses (Chapter 10) and kinetic testing (Chapter 18) are also important for interpreting ABA results.

The rinse pH is indicative of the present drainage pH of a sample. Material categories for future drainage pH are potentially acidic rock drainage generating (PAG) and not potentially acidic rock drainage generating (Non-PAG). For cases where AP and NP are equally exposed and AP generates acid identical to pyrite and NP neutralizes acid like calcite, samples with an NPR less than 1.0 are PAG and samples with an NPR greater than 2.0 are non-PAG. A sample with an NPR between 1.0 and 2.0 is capable of generating acid rock drainage (ARD).

Site specific factors that may alter the relative magnitude of AP and NP include: AP and NP sources whose generation and neutralization of acid differs from pyrite and calcite, differences in AP and NP exposure and the location and length of flow paths. Other considerations in setting NPR criteria for PAG vs. Non-PAG are external sources of AP and NP and safety factors that account for limitations in the precision and accuracy of sampling, determination of the effective AP and NP and material handling.

The minimum AP, sulphide-S or acidic sulphate-S capable of causing ARD is not a generic number, but depends on the magnitude of the effective NP. A % S cut-off should not be used as the only means of assessing ARD potential unless the minimum NP value is known.

The onset of ARD may occur in a few years or take hundreds of years. The absence of ARD up to the present does not on its own prove that ARD will not occur in the future.

Criteria used to guide decisions regarding the potential for future acidic drainage are a key component of sound environmental and fiscal management. Drainage chemistry prediction should be conducted even for Non-PAG material because environmental impacts can also occur due to near-neutral and alkaline pH drainage.

### **Chapter 15: NAG Tests**

Net Acid Generation or NAG tests use hydrogen peroxide ( $H_2O_2$ ), a strong oxidizing agent capable of rapidly oxidizing sulphide minerals, to assess whether a sample is capable of neutralizing the potential acidity. NAG testing may involve a (1) single addition NAG test for low sulphide samples, (2) sequential NAG test for higher levels of sulphide, (3) partial ABA consisting of total sulphur, NP, and paste pH, (4) kinetic NAG test to obtain estimates of mineral reactivity and (5) acid buffering characteristic curve (ABCC). The sequential NAG test should be conducted where the breakdown of the hydrogen peroxide due to reactions with sulphide surfaces, organic matter, sulphide oxidation products or other sources of reactive metals may incorrectly indicate the neutralizing capacity is large enough to maintain pH neutral to alkaline drainage.

### **Chapter 16: Particle Size Separation and Analysis**

Particle size distribution of sulphidic geologic materials can play an important role in drainage chemistry prediction because of its effects on mineral reactivity and the movement of water and gases. These effects result from the relationships among particle size, pore size, grain exposure and exposed surface area. For example, a waste rock boulder may contain a much higher concentration of hard minerals like quartz and K-feldspar, while softer minerals like calcite, gypsum and phyllosilicates are concentrated in the finer size fractions. Geometric surface area, based on particle size distributions, can be calculated from equations in textbooks or by free software.

### **Chapter 17: Mineralogical Properties**

Mineralogical analyses measure properties of individual mineral phases and their contributions to geologic materials as a whole. Mineralogical information is an essential component of drainage chemistry prediction because mineralogical properties determine the physical and geochemical stability and relative weathering rates of geological materials under different weathering conditions. This is important for the selection, design, check of assumptions and interpretation of the results of other static and kinetic tests.

The mineralogical methods discussed in this chapter are: visual descriptions, petrographic analysis, X-ray Diffraction (XRD) preferably by the Rietveld Method, Scanning Electron

Microscopy coupled with energy dispersive X-ray Spectroscopy (SEM/EDS), Electron Microprobe, laser ablation and other microbeam analyses, image analysis and calculated mineralogy from solid phase elemental data. Each method has strengths and weaknesses. As a minimum, prediction programs generally should include visual descriptions, petrographic analysis and X-ray Diffraction analyses.

### **Chapter 18: Humidity Cell Procedures**

For sulphidic geologic materials, the decades old, well-flushed humidity cell with alternating dry and humid air is the recommended kinetic test for predicting primary reaction rates under aerobic weathering conditions. The resulting data provide primary rates of elemental release, acid generation and acid neutralization. This information can provide site specific NPR criteria for interpreting ABA data (Chapter 14) and, when combined with solid phase analyses, also provide depletion times for NP, sulphide and various elements. However, these cells do not usually simulate the precipitation and dissolution of secondary weathering products, which often determine drainage chemistry under field conditions. Cells should continue until rates have stabilized at relatively constant levels for at least five weeks. When a cell is terminated, the closedown procedure should be conducted for better interpretations and for post-test validation of cell results.

### **Chapter 19: Kinetic Tests that Measure Primary Mineral Weathering and Secondary Mineral Precipitation and Dissolution**

Drainage chemistry depends on both the primary mineral reactions (Chapter 18) and the precipitation and dissolution of the resulting secondary minerals. This chapter discusses several kinetic tests that can examine both primary and secondary aspects at the same time and thus provide more direct predictions of drainage chemistry. These tests are: trickle leach columns (both subaerial and subaqueous types), field test cells including leach pads and barrels, MEND wall-washing stations, full-scale monitoring data and previously weathered materials like outcrops or old rock piles. However, large disparities may exist among these tests and full-scale project components due to differences in sample preparation, site climatic conditions, sample size, scale and particle size. Even without these disparities, the equilibrium solubility processes and reaction product retention that play significant roles in determining drainage chemistry cannot always be reliably identified, even after decades of monitoring or testing.

### **Chapter 20: Modeling Drainage Chemistry**

Drainage chemistry modeling can assist with the interpretation of test work and monitoring results and may improve the prediction of drainage chemistry and loadings. However, modeling cannot substitute for good site specific monitoring and understanding. Modeling predictions need to be tested before they can be accepted.

Brief overviews of three basic categories of drainage chemistry modeling are presented in this chapter: empirical modeling, speciation and mineral equilibrium modeling and complex models. If a minimum of hundreds of water analyses are available for a particular site, then these analyses can be compiled into a statistical “empirical drainage chemistry model” (EDCM). The

second category applies pre-selected chemical reactions, equilibrium constants and mineral solubilities to a particular water analysis to estimate aqueous concentrations of all pertinent chemical species and determine whether minerals are close to saturation. Complex models simulate more than just chemistry and can include water and gas-phase movement across an entire mine site.

### **Chapter 21: Checklist of Important Information for the Prediction of Drainage Chemistry**

This chapter provides a detailed checklist of potentially important information for predicting drainage chemistry from sulphidic materials. This list is intended to make the technical specialist aware of general issues and the generalist practitioner aware of detailed information requirements. Every mine site has unique combinations of environmental, geological and operational conditions. For any particular site, some properties and processes within this list may not be relevant. Similarly, there will be instances where there are additional factors to consider. Minimizing environmental risks and liability includes consideration of near-neutral and alkaline conditions, as well as acidic drainages and the reduction of water and/or oxygen entering a project component. At each stage of prediction, one should consider the purpose of the test work and whether the results will impact site management, liability or the risk to the environment. In some cases, the provision of contingency mitigation measures coupled with operational testing during mining will be more effective than additional pre-mining prediction test work, which could be inconclusive or of limited significance to the overall mine plan. In all cases, there is never complete understanding, so a critical part of any drainage chemistry prediction is identifying and dealing with uncertainty.

## PRÉFACE

La prévision de la chimie des eaux de drainage est un sujet technique qui englobe un grand nombre de méthodes, de propriétés et de processus. Ce manuel a pour but de fournir les renseignements vastes et approfondis nécessaires à la réalisation d'un programme de prévision de la chimie des eaux de drainage et à l'examen des résultats d'un tel programme. Ce document est donc volumineux et détaillé et contient des répétitions de certaines informations primordiales.

Des gens de nombreux horizons différents consulteront ce manuel. Certains seront des experts en sciences physiques, chimiques ou biologiques. D'autres seront des ingénieurs, des géologues ou des pédologues ou encore des non-spécialistes du domaine qui veulent mieux comprendre le processus de drainage des sites miniers. L'objectif consiste à donner la vue d'ensemble et les explications techniques approfondies dont les experts et les novices auront besoin.

La façon de consulter le manuel pour y trouver de l'information sur des aspects particuliers de la prévision est décrite à la page suivante.

L'information fournie dans le présent document représente les points de vue de l'auteur et ne doit pas être considérée comme ayant été approuvée, en tout ou en partie, par les personnes qui ont examiné le document ou par les partenaires du NEDEM (gouvernement du Canada, gouvernements provinciaux, Association minière du Canada et sociétés minières et organisations non gouvernementales). L'utilisateur du présent document est entièrement responsable de ses propres travaux de prévision et d'atténuation de la chimie des eaux de drainage provenant de matériaux géologiques sulfurés (lixiviation des métaux et drainage rocheux acide) et de toute mesure prise en fonction de l'information contenue dans le présent document.

Ressources naturelles Canada veut améliorer les pratiques existantes. Les commentaires au sujet du présent document ou les suggestions pour l'améliorer seront très appréciés. Ils doivent être soumis à l'auteur, à l'adresse suivante : [bprice@rncan.gc.ca](mailto:bprice@rncan.gc.ca) , ou au :

Laboratoires des mines et des sciences minérales de CANMET  
Ressources naturelles Canada  
C.P. 5000  
3793 Ave. Alfred  
Smithers (Colombie-Britannique)  
Canada V0J 2N0



## CONSULTATION DE CE MANUEL

Comme ce manuel est volumineux, il est assorti de nombreux guides qui en facilitent la consultation.

- La page (**PA-3**) renferme un schéma qui montre comment les chapitres sont réunis en des groupes et des séquences pour la prévision de la chimie des eaux de drainage provenant de matériaux géologiques sulfurés.
- Suivent plusieurs pages contenant des résumés de certains des principaux points de chacun des chapitres.
- La table des matières, qui commence à la page **PA-26**, montre que le manuel est divisé en de grands sujets traités dans des chapitres, des sections et des sous-sections.
- Les pages **PA-39** à **PA-44** renferment les listes des figures et des tableaux inclus dans le manuel.
- Chacun des chapitres commence par une zone de texte soulignant les principaux points du chapitre. Plusieurs zones plus petites sont réparties dans tout le document pour attirer l'attention sur des faits utiles et des renseignements importants.
- Enfin, le chapitre 21 est suivi d'un glossaire contenant la définition de nombreux termes techniques et acronymes utilisés dans le manuel.

## SCHEMA DES CHAPITRES

### Processus recommandé pour prédire la chimie des eaux de drainage des sites miniers

Examiner les objectifs généraux et les questions (**chapitres 2, 3 et 4**), une certaine part de la théorie et de l'information relatives à la technique (**chapitre 5**) et l'information générale sur le site et le projet (**chapitres 6 et 7**).



Identifier les unités lithostratigraphiques et les unités de rejets exposées ou touchées par l'exploitation minière, le broyage du minerai, la concentration du minerai et la construction des installations (**chapitre 6**).



Déterminer la forme et l'étendue de chacune des unités lithostratigraphiques et des unités de rejets dans chacun des éléments de la mine, par exemple, les résidus et des haldes de stériles (**chapitre 7**).



Déterminer la température, le degré d'aération, l'hydrogéologie et le volume des eaux de drainage de chacun des éléments de la mine – l'évaluation est possible à partir des données sur l'hydrologie et l'hydrogéologie du site et le climat (**chapitres 6 et 7**).



Prélever des échantillons des unités lithostratigraphiques et des unités de rejets qui sont représentatives des unités et des éléments de la mine, en suivant les recommandations quant à leur nombre, leur taille, leur volume, leur description et leur manutention (**chapitre 8**).



Effectuer des essais statiques et en interpréter les résultats (**chapitres 9 à 17, 20 et 21**) pour déterminer la composition des échantillons choisis (**chapitre 8**).



Effectuer des essais cinétiques et en interpréter les résultats (**chapitres 18 à 21**), d'après les résultats des essais statiques (**chapitres 9 à 17**) effectués sur les échantillons choisis (**chapitre 8**).



Prédire la chimie des eaux de drainage sur une certaine période, pour chacun des éléments de la mine (**chapitre 7**), selon les rajustements apportés aux résultats des essais statiques et cinétiques pour le débit prévu, le volume et le degré d'aération ou de submersion (**chapitres 6, 20 et 21**).

\* À exécuter après chacune des étapes :

- réviser la classification des unités lithostratigraphiques et des unités de rejets, au besoin;
- créer des unités provisoires de gestion et déterminer leurs besoins en matière de suivi, d'atténuation et de manutention des matériaux ainsi que les conditions d'exposition ainsi mises en place.

## RÉSUMÉ DE QUELQUES POINTS IMPORTANTS DE CHACUN DES CHAPITRES

### Chapitre 1 : Introduction

Les eaux de drainage qui traversent des matériaux géologiques sulfurés peuvent contenir des concentrations élevées de métaux et d'autres éléments, peu importe le pH, et entraîner de ce fait de coûteux travaux d'assainissement et de gestion de l'environnement. Pour pouvoir prendre des mesures d'atténuation efficaces, rentables et proactives, il faut disposer de prévisions précises de la chimie des eaux de drainage dans l'avenir. L'on doit prédire la chimie des eaux de drainage qui traversent des matériaux géologiques sulfurés si l'on veut s'assurer que l'extraction des ressources minérales du Canada est judicieuse du point de vue financier et minimise les impacts sur les terres et les cours d'eau adjacents.

Des principes directeurs sont fournis quant aux points forts et aux éventuelles contraintes des différents essais, procédures, analyses et critères utilisés pour prédire la chimie des eaux de drainage dans l'avenir. L'auteur de ce manuel recommande de toujours faire des prévisions propres à un site. Les utilisateurs du manuel doivent tenir compte des conditions locales du site, par exemple les facteurs d'altération climatique, de l'étape du développement du projet, des matériaux géologiques, des éléments de la mine, des objectifs environnementaux et des besoins du projet au moment de choisir parmi les procédures du manuel et de retenir une façon d'interpréter les résultats. Ce manuel n'a pas été produit dans le but d'entraver les méthodes utilisées correctement ou de remplacer les personnes possédant la formation et l'expérience techniques appropriées.

### Chapitre 2 : Les objectifs globaux de la prévision

On prédit la chimie des eaux de drainage afin de déterminer les mesures nécessaires pour prévenir tout impact environnemental important, soit le type de mesure, l'ampleur de la mesure et le bon moment et le bon endroit pour la mettre en oeuvre. Pour atteindre cet objectif, on détermine la chimie actuelle des eaux de drainage; prédit la chimie future des eaux de drainage; identifie les propriétés et les processus influant sur la chimie des eaux de drainage; prédit le moment où la chimie des eaux de drainage et les propriétés et les processus influant sur cette chimie subiront d'importants changements. Des prévisions doivent être faites pour tous les matériaux géologiques sulfurés excavés, exposés ou remaniés de toute autre manière.

Notre connaissance des propriétés et des processus déterminant la chimie des eaux de drainage est loin d'être parfaite. Toutefois, les instruments de prévision disponibles conjugués à une approche suffisamment vaste, bien orientée, et à une interprétation prudente des résultats devraient permettre aux exploitants des mines contenant des matériaux géologiques sulfurés d'atteindre les objectifs établis pour le milieu récepteur et de minimiser la responsabilité financière et le risque. La chimie prévue des eaux de drainage sera souvent exprimée sous la forme d'une gamme de concentrations de contaminants, étant donné la diversité des propriétés de chacune des unités géologiques et des unités de gestion des rejets et le manque d'exactitude et de précision des méthodes de prévision. L'imprévisibilité de la chimie des eaux de drainage devrait être réduite au point de permettre que des plans soient conçus et mis en oeuvre afin d'atteindre les objectifs environnementaux.

### **Chapitre 3 : Les principes généraux et les pratiques exemplaires**

Pour la prévision de la chimie des eaux de drainage, la pratique exemplaire à suivre consiste à faire la prévision propre à un site et à adopter une démarche proactive. La chimie des eaux de drainage doit être prévue pour tous les matériaux géologiques qui seront excavés, exposés ou remaniés de toute autre manière (les éléments du projet). Le processus de prévision doit tenir compte de la variabilité spatiale et de la modification temporelle des propriétés et des processus contribuant à la chimie des eaux de drainage et avoir une approche itérative progressive et scientifique. Étant donné le grand nombre de facteurs en cause, une bonne planification doit absolument faire partie du processus de prévision, car son succès en dépend. Le processus de prévision doit s'échelonner sur toute la vie du projet. À chacune des étapes, l'objectif consiste à démontrer que le projet rassemble le savoir, les capacités, les ressources et la volonté nécessaires pour protéger l'environnement. Plusieurs défis doivent être relevés dans le cadre du processus de prévision. Il faut notamment composer avec l'imprévisibilité et les changements apportés aux plans de la mine. Il est important d'identifier les matériaux et les méthodes ainsi que les utilisations prévues avant d'entamer le processus de prévision; d'utiliser de la terminologie clairement définie; de s'assurer de la rentabilité de chacune des étapes des essais avant de l'entamer. Le processus de prévision nécessite du personnel qualifié et des ressources adéquates. Tenir à jour l'information sur la prévision, dans une forme accessible qui facilite son examen régulier et le suivi de ses changements, est, elle aussi, une activité extrêmement importante. Les praticiens doivent connaître les erreurs de prévision commises dans le passé, faire preuve de prudence et se souvenir qu'un savoir suffisant ne peut être obtenu que par un examen des renseignements sur les conditions du site, l'échantillonnage, la préparation des échantillons, les analyses, le déroulement des essais et l'interprétation des données.

### **Chapitre 4 : Les principales étapes d'un programme de prévision**

La prévision de la chimie des eaux de drainage se compose de trois grandes étapes. Premièrement, les propriétés générales du projet et du site doivent être examinées. Deuxièmement, la chimie actuelle des eaux de drainage doit être déterminée et surveillée, et cette chimie doit être prévue pour l'avenir. Troisièmement, les prévisions faites à l'étape précédente doivent être vérifiées périodiquement et mises à jour au besoin, et toute lacune importante dans l'information doit être identifiée et soulignée. La troisième étape doit être répétée durant toute la vie du projet.

### **Chapitre 5 : Les paramètres et les processus contrôlant la chimie des eaux de drainage**

De nombreux paramètres et processus propres à un site influent sur la chimie des eaux de drainage qui traversent des matériaux géologiques sulfurés. Ce chapitre examine les plus importants du point de vue géochimique.

### **Chapitre 6 : Les conditions du site**

Comme la prévision de la chimie des eaux de drainage nécessite beaucoup d'informations particulières au site, de nombreux aspects importants des conditions du site sont énumérés et examinés dans ce chapitre. La géographie locale et régionale, le climat, l'hydrologie et l'hydrogéologie doivent être définis. Comme la chimie des eaux de drainage sera

vraisemblablement modifiée par l'exploitation minière, des études détaillées des enjeux géologiques doivent être faites. Il faut notamment étudier les variations spatiales dans les sols, les morts-terrains et les unités lithostratigraphiques. Les besoins et les attentes de la collectivité locale, des organismes de réglementation, de la compagnie et des autres intervenants sont, eux aussi, des aspects importants des conditions particulières du site.

### **Chapitre 7 : Le projet et ses éléments**

Chacun des projets et chacun des sites doit être divisé en ses éléments, par exemple les mines à ciel ouvert, les chantiers souterrains, les haldes de stériles, les tas de minerai à basse teneur, les parcs à résidus et les matériaux d'emprunt. Les prévisions sur le drainage peuvent ensuite être faites pour chacun des éléments, en tenant compte de la combinaison unique des conditions et de la configuration du site. Ces prévisions nécessitent de l'information sur une myriade de combinaisons de propriétés et de processus physiques, géochimiques, biologiques et techniques propres au site. On énumère et examine dans ce chapitre un grand nombre de ces propriétés et processus. On examine entre autres leur éventuelle modification au fil du temps. Ainsi, la chimie des eaux de drainage s'échappant d'une mine à ciel ouvert peut, au départ, refléter l'altération des parois de la mine mais, plus tard, elle peut refléter la formation d'un talus avec une granulométrie à grains fins ce qui représente une vaste zone superficielle réactive. Enfin, l'abaissement ou la remontée de la nappe phréatique peut modifier grandement le taux d'oxydation tout en touchant inversement les charges dans les eaux de drainage.

### **Chapitre 8 : La sélection, l'entreposage et la préparation des échantillons**

La sélection, l'entreposage et la préparation des échantillons sont des étapes cruciales dans le cadre de la prévision de la chimie des eaux de drainage qui traversent des matériaux géologiques sulfurés. Si un échantillon n'est pas choisi et entreposé correctement, tout le temps et toutes les ressources financières consacrés aux analyses et aux interprétations peuvent s'avérer un pur gaspillage. Il faut procéder avec beaucoup de soin pour décider, par exemple, du matériau à échantillonner, de la méthode et de la fréquence de l'échantillonnage, et du volume de l'échantillon et également si l'échantillon doit être concassé ou broyé, de remplacer des échantillons par des échantillons d'autres sources et s'il faut séparer les particules plus grossières et moins réactives des particules plus fines et plus réactives. Chacun des échantillons doit être décrit en détail et, de préférence, géoréférencé à un emplacement et à une profondeur au site ou le projet. Par exemple, les échantillons de déblais de forage sont souvent géoréférencés et placés dans les modèles géologiques du site. Des caractéristiques comme la couleur peuvent donner une idée de l'altération, de la lixiviation et de l'oxydation aux fins de l'échantillonnage, mais la couleur n'est pas toujours un indice fiable.

### **Chapitre 9 : Un aperçu des essais statiques et cinétiques**

Les analyses et les essais effectués pour prédire la chimie des eaux de drainage consistent en un essai statique exécuté une fois et en des essais cinétiques répétitifs. Il existe de nombreux types d'essais statiques. Il y a, par exemple, le bilan acide-base et les analyses élémentaires totales, qui nécessitent relativement peu de temps. Les essais cinétiques, dont les cellules d'humidité en laboratoire et les remblais de lixiviation érigés sur place, prennent quant à eux des années à

exécuter et sont plus dispendieux. C'est pourquoi les essais cinétiques sont souvent exécutés uniquement sur les échantillons identifiés comme importants et représentatifs par suite des essais statiques. De plus, certains essais cinétiques fournissent la vitesse de réaction primaire alors que d'autres fournissent directement la prévision de la chimie des eaux de drainage après des processus supplémentaires. Par conséquent, les objectifs de tout essai doivent être examinés et énoncés avec soin. Le débit doit toujours être mesuré dans un essai cinétique, car cela facilite l'interprétation des résultats. De nombreux essais statiques et cinétiques fournissent des renseignements qui sont similaires ou qui se complètent. Tout écart doit donc être étudié et corrigé. Les résultats des essais doivent être compilés avec soin, accompagnés de statistiques descriptives et représentés sur des diagrammes de dispersion.

### **Chapitre 10 : L'analyse élémentaire en phase solide au niveau de tout l'échantillon ou quasi totale**

Les analyses examinées dans ce chapitre fournissent la quantité totale ou quasi totale des éléments chimiques choisis qui sont présents dans un échantillon en phase solide. L'analyse se divise en deux grandes étapes. Premièrement, la plupart de l'échantillon ou tout l'échantillon est digéré dans un flux chimique chaud ou dans un mélange d'acides forts. Deuxièmement, l'échantillon digéré est analysé. Plusieurs techniques peuvent être utilisées à cette fin, par exemple la fluorescence X (XRF) ou le plasma inductif (ICP). Il est important de connaître les points forts et les points faibles de chacune des méthodes de digestion et d'analyse parce que la méthode peut influencer sur les prévisions de la chimie des eaux de drainage provenant de matériaux sulfurés. Par exemple, les analyses qui fournissent la quantité totale pour tout l'échantillon peuvent donner des résultats en équivalents d'oxyde, comme le CaO et l'Al<sub>2</sub>O<sub>3</sub>. En pareil cas, il faut soumettre les résultats à des conversions mathématiques pour obtenir les concentrations réelles des éléments. Ces analyses ne révèlent pas sous quelles formes les éléments sont présents dans l'échantillon – elles ne permettent pas de savoir, par exemple, si les éléments sont présents dans un seul ou dans plusieurs minéraux – mais il est quelquefois possible de déduire cette information à partir de quelques hypothèses. En outre, les niveaux de la phase solide, qu'ils soient élevés ou non, ne sont pas en eux-mêmes des indicateurs des concentrations dans les eaux de drainage ou du risque pour l'environnement. Toutefois, les résultats d'essais décrits dans d'autres chapitres sont ajoutés aux résultats de cette analyse en phase solide aux fins de la prévision des eaux de drainage. C'est le cas notamment du temps nécessaire pour que l'élément soit entièrement lixivié de l'échantillon.

### **Chapitre 11 : L'analyse des composants solubles**

Les matériaux géologiques sulfurés sont souvent composés de suites de minéraux dont la solubilité varie de relativement peu élevée à élevée. Les minéraux les plus solubles peuvent souvent se dissoudre rapidement et donner immédiatement leur chimie aux eaux de drainage. Toutefois, la chimie de l'eau locale, le temps de contact (temps de séjour) et le rapport entre l'eau et les solides peuvent, eux aussi, influencer sur la dissolution des composants solubles. Pour mesurer ces derniers, on recommande de mettre l'échantillon dans des fioles incubées sous agitation, avec une répartition par défaut de 3 unités de poids de solides pour 1 unité de poids d'eau, et d'agiter doucement le mélange durant 24 heures. Ces conditions de l'essai peuvent être modifiées au besoin en fonction du site. Il est important de parvenir à un équilibre, notamment à

l'égard des limites de la solubilité des minéraux, parce que la dissolution nette arrête et les concentrations aqueuses ne s'élèvent pas davantage. Par conséquent, lors des essais sur les composants solubles, il est important de pouvoir identifier le moment où l'équilibre est atteint. Pour vérifier si les limites de l'équilibre ont été atteintes, on peut lixivier un échantillon une deuxième fois avec de la nouvelle eau ou selon des rapports entre l'eau et les solides différents. Pour voir si le temps de séjour a eu un effet sur les résultats, on peut lixivier le résidu solide plus longtemps ou pour une deuxième fois qui sera plus longue que la première. La mesure du pH superficiel (du pH après rinçage), du pH de la matière concassée et du pH de la pâte (matière pulvérisée) donne, elle aussi, une idée des composants solubles des échantillons.

### **Chapitre 12 : Les espèces sulfurées et le potentiel de production d'acidité (PA)**

Les diverses espèces sulfurées sont la principale source d'acide délétère, d'acidité et d'espèces élémentaires dans les eaux de drainage des matériaux géologiques sulfurés. Leurs effets sur la chimie des eaux de drainage dépendent de facteurs comme l'abondance, l'état de l'oxydation, les impuretés, les propriétés physiques et les conditions environnementales du milieu local. Les principaux minéraux et espèces sulfurés sont les sulfures, les sulfosels, les sulfates, le soufre organique et les espèces présentant des états d'oxydation intermédiaires. Le sulfure est surtout combiné à du fer dans des minéraux comme la pyrite, la pyrrhotite, la marcassite et les monosulfures. Quant aux minéraux sulfatés, ils peuvent être groupés en basiques très solubles; acides très solubles; basiques modérément solubles; acides peu solubles; extrêmement solubles.

L'analyse du soufre a pour objectif d'identifier et de mesurer la concentration et la composition des diverses espèces sulfurées avec suffisamment d'exactitude et de précision. Cela est important pour le calcul du potentiel de production d'acidité (PA) et la prévision de la libération d'espèces élémentaires sous l'effet d'une altération. Plusieurs méthodes permettant de mesurer les espèces sulfurées examinées dans ce chapitre. Par exemple, Leco est un fabricant de fours à induction à haute température dont le nom évoque automatiquement la méthode la plus utilisée pour déterminer le carbone total et le soufre total. Toutes les méthodes ont des points forts et des points faibles. Il faut les connaître pour pouvoir faire de bonnes prévisions à partir des données de l'analyse.

### **Chapitre 13 : Le potentiel de neutralisation (PN)**

L'expression « potentiel de neutralisation » (ou PN) est actuellement utilisée pour une vaste gamme de mesures en laboratoire et de prévisions du PN sur le terrain. Dans le cas des matériaux géologiques sulfurés, le principal problème réside dans la neutralisation du potentiel de production d'acidité (chapitre 12). Le pH des eaux de drainage est acide lorsque les minéraux neutralisants sont épuisés ou lorsque le taux de neutralisation est inadéquat.

Plusieurs propriétés et processus sont importants pour l'évaluation du « PN réel » sur le terrain à partir des analyses du PN en laboratoire, notamment 1) la nature, la concentration et les mécanismes d'altération des minéraux, 2) leur contribution au PN mesuré et 3) leurs taux cumulatifs de production d'alcalinité par rapport au taux de production d'acidité dans les conditions propres au site, pour chacun des éléments du projet. Certains minéraux carbonatés

neutralisent rapidement et, de ce fait, contribuent plus au PN réel que les carbonates de fer ferreux et de manganèse.

Pour mesurer le PN, on peut utiliser diverses méthodes, notamment la méthode de Carbonate, la méthode de Sobek (U.S. EPA 600), plusieurs méthodes modifiées, la méthode de BC Research et la méthode de Lapakko. Chacune des méthodes a des points forts et des points faibles uniques. Par conséquent, aucune des méthodes n'est la meilleure pour évaluer le PN réel. Cependant, la comparaison de la méthode de Carbonate avec l'une des autres méthodes pour le PN apparent aide à évaluer le pourcentage du carbonate réactif qui contribue au PN apparent.

#### **Chapitre 14 : Le bilan acide-base et les critères utilisés pour prédire la possibilité du drainage acide**

Le drainage acide survient lorsque le taux de production d'acidité dépasse le taux de neutralisation de l'acidité. Le bilan acide-base est une série d'analyses et de calculs utilisés pour évaluer la possibilité que l'altération des minéraux soit une source de drainage acide. Le bilan acide-base inclut le pH après rinçage et le pH de la pâte (chapitre 11), les espèces sulfurées et le PA (chapitre 12) et le PN (chapitre 13). Le chapitre sur la minéralogie (chapitre 17), les analyses élémentaires (chapitre 10) et les essais cinétiques (chapitre 18) sont, eux aussi, importants pour interpréter les résultats du bilan acide-base.

Le pH après rinçage donne une idée du pH actuel d'un échantillon des eaux de drainage. Les matériaux qui entrent en jeu quant au pH futur des eaux de drainage sont les générateurs de drainage rocheux acide (GDA) et les non générateurs de drainage rocheux acide (Non-GDA). Lorsque l'exposition au PA et au PN est égale et que le PA génère de l'acide identique à la pyrite et que le PN neutralise l'acide comme la calcite, les échantillons avec un rapport PN/PA de moins de 1,0 sont des GDA et les échantillons avec un PN/PA supérieur à 2,0 sont des Non-GDA. Un échantillon dont le rapport PN/PA se situe entre 1,0 et 2,0 peut générer du DRA.

Les facteurs propres au site qui peuvent modifier l'importance relative du PA et du PN comprennent les sources du PA et du PN dont la production d'acidité et la neutralisation de l'acidité diffèrent de celles de la pyrite et de la calcite, les différences dans l'exposition au PA et au PN et l'emplacement et la longueur du trajet d'écoulement des eaux. D'autres points doivent être pris en compte dans l'établissement des critères pour le rapport PN/PA à l'égard des GDA et les Non-GDA, soit les sources externes du PA et du PN et les facteurs de sécurité qui restreignent la précision et l'exactitude de l'échantillonnage, la détermination du PA et du PN réels et la manutention des matériaux.

Le seuil minimal pour que le PA, le soufre sous la forme de sulfure ou le soufre sous la forme de sulfate acide puisse causer du DRA n'est pas un chiffre générique. Il dépend plutôt de l'importance du PN réel. Un seuil pour le soufre exprimé en % ne doit pas être utilisé comme seul moyen d'évaluer le potentiel de DRA à moins que la valeur minimale du PN soit connue.

Le DRA peut prendre quelques années ou des centaines d'années à se manifester. L'absence de DRA jusqu'à maintenant ne veut pas dire qu'il n'y aura pas de DRA dans l'avenir.



Les critères utilisés pour orienter les décisions au sujet de la possibilité d'un drainage acide dans l'avenir forment l'une des composantes clés d'une bonne gestion budgétaire et environnementale. Il faut procéder à la prévision de la chimie des eaux de drainage même lorsque les matériaux sont des Non-GDA parce que l'environnement peut être touché par des eaux de drainage au pH quasi neutre ou alcalin.

### **Chapitre 15 : Les tests de production d'acidité nette (tests PAN)**

Les tests PAN utilisent du peroxyde d'hydrogène ( $H_2O_2$ ), un puissant oxydant capable d'oxyder rapidement des minéraux sulfurés, pour évaluer si l'échantillon est capable de neutraliser l'acidité. Les tests PAN peuvent consister en 1) un seul test PAN dans le cas de minéraux peu sulfurés, en 2) un test PAN séquentiel si les minéraux sont plus sulfurés, en 3) un bilan acide-base partiel pour le soufre total, le PN et le pH de la pâte, en 4) un test cinétique PAN qui permettra d'évaluer la réactivité des minéraux et en 5) une courbe des caractéristiques de la neutralisation (acid buffering characteristic curve). Le test PAN séquentiel doit être effectué lorsque la décomposition du peroxyde d'hydrogène causée par les réactions avec les surfaces sulfurées, la matière organique, les produits de l'oxydation des sulfures ou d'autres sources de métaux réactifs peut indiquer à tort que la capacité de neutralisation est assez élevée pour maintenir le pH des eaux de drainage de neutre à alcalin.

### **Chapitre 16 : La répartition granulométrique et l'analyse**

La granulométrie des matériaux géologiques sulfurés peut jouer un rôle important dans la prévision de la chimie des eaux de drainage étant donné ses effets sur la réactivité des minéraux et le mouvement de l'eau et des gaz. Ces effets découlent du rapport entre la granulométrie, la dimension des pores, l'exposition du grain et la surface active exposée. Par exemple, un bloc de stériles peut contenir une concentration beaucoup plus élevée de minéraux durs comme le quartz et le feldspath potassique, alors que les minéraux mous comme la calcite, le gypse et les phyllosilicates sont concentrés dans les fractions les plus fines. La surface géométrique active, qui repose sur la distribution granulométrique, peut être calculée à partir des équations incluses dans les manuels ou au moyen de logiciels libres.

### **Chapitre 17 : Les propriétés minéralogiques**

Les analyses minéralogiques permettent de mesurer les propriétés des diverses phases minérales et leur contribution aux matériaux géologiques dans leur ensemble. L'information minéralogique est une composante essentielle de la prévision de la chimie des eaux de drainage parce que les propriétés minéralogiques dictent la stabilité physique et géochimique et les taux relatifs d'altération des matériaux géologiques selon les différentes conditions d'altération. Cela est important pour la sélection et la conception des autres essais statiques et cinétiques, la vérification des hypothèses de ces essais et l'interprétation des résultats de ces essais.

Les méthodes minéralogiques examinées dans ce chapitre sont les suivantes : les descriptions visuelles, l'analyse pétrographique, la diffraction des rayons X (de préférence avec la méthode de Rietveld), la microscopie électronique à balayage jumelée à la spectrométrie de rayons X à dispersion d'énergie, la microsonde électronique, l'ablation par laser et d'autres analyses au

moyen de microfaisceaux, l'analyse d'image et la minéralogie calculée à partir des données pour chacun des éléments en phase solide. Chacune des méthodes a ses points forts et ses points faibles. En général, les programmes de prévision doivent comprendre au moins des descriptions visuelles, une analyse pétrographique et des analyses par diffraction des rayons X.

### **Chapitre 18 : Les cellules d'humidité**

Pour les matériaux géologiques sulfurés, la cellule d'humidité bien rincée et soumise à une alternance d'air sec et humide est l'essai cinétique recommandé pour la prévision de la vitesse de réaction des minéraux primaires dans des conditions d'altération aérobie. Les données recueillies grâce à cet essai fournissent les vitesses de libération des éléments des minéraux primaires, la production d'acidité et la neutralisation de l'acidité. Cette information peut fournir des critères pour le rapport PN/PA du site qui sont utiles pour interpréter les données sur le bilan acide-base (chapitre 14) et, lorsqu'elle est amalgamée aux analyses en phase solide, elle peut également indiquer les temps d'épuisement pour le PN, le sulfure et les divers éléments. Cependant, en général, ces cellules ne simulent pas la précipitation et la dissolution des produits secondaires de l'altération, qui, souvent, déterminent la chimie des eaux de drainage dans les conditions naturelles. Les cellules doivent être maintenues jusqu'à ce que les vitesses se stabilisent à des niveaux relativement constants durant au moins cinq semaines. Une fois que la cellule est épuisée, la procédure prévue pour sa fermeture doit être appliquée, car cette procédure permet de meilleures interprétations et favorise la validation des résultats une fois les essais terminés.

### **Chapitre 19 : Les essais cinétiques qui permettent de mesurer l'altération des minéraux primaires et la précipitation et la dissolution des minéraux secondaires**

La chimie des eaux de drainage dépend des réactions des minéraux primaires (chapitre 18) et de la précipitation et de la dissolution des minéraux secondaires libérés. Ce chapitre examine plusieurs essais cinétiques qui peuvent porter à la fois sur les minéraux primaires et secondaires et ainsi fournir des prévisions plus directes de la chimie des eaux de drainage. Ces essais sont les suivants : colonnes de lixiviation par perfusion (subaériennes et subaquatiques), cellules d'essai sur le terrain (par exemple, remblais de lixiviation et barils de lixiviation), postes de lavage de paroi mis au point par le NEDEM, données de suivi à pleine échelle et matériaux déjà altérés (par exemple, des affleurements ou de vieux amas de roche). Toutefois, de grands écarts peuvent exister entre ces essais et les éléments du projet à pleine échelle, en raison des différences dans la préparation des échantillons, les conditions climatiques des sites, la taille des échantillons, l'échelle du projet et la granulométrie. Même si ces écarts n'existaient pas, les processus liés à la solubilité d'équilibre et la conservation des produits de la réaction qui jouent un grand rôle dans la détermination de la chimie des eaux de drainage ne peuvent pas toujours être identifiés avec certitude, même après des décennies de suivi ou d'essais.

### **Chapitre 20 : La modélisation de la chimie des eaux de drainage**

La modélisation de la chimie des eaux de drainage peut s'avérer utile pour interpréter les résultats des essais et du suivi et peut améliorer la prévision de la chimie des eaux de drainage et des charges. Toutefois, la modélisation ne saurait remplacer un bon programme de suivi et une

bonne connaissance du site. Les prévisions basées sur une modélisation doivent être mises à l'épreuve avant qu'elles puissent être acceptées.

De brefs aperçus des trois catégories de base de la modélisation de la chimie des eaux de drainage sont présentés dans ce chapitre, soit la modélisation empirique, la modélisation de la spéciation et de l'équilibre minéralogique et les modèles complexes. Si des centaines d'analyses de l'eau sont disponibles pour un site donné, ces analyses peuvent être compilées dans un modèle empirique de la chimie des eaux de drainage. La deuxième catégorie applique des réactions chimiques présélectionnées, les constantes d'équilibre et la solubilité des minéraux à une analyse de l'eau particulière afin d'évaluer les concentrations aqueuses de toutes les espèces minérales pertinentes et de déterminer si les minéraux s'approchent de la saturation. Les modèles complexes ne simulent pas que la chimie. Ils peuvent inclure le mouvement entre la phase aqueuse et la phase gazeuse à l'échelle d'un site minier.

### **Chapitre 21 : La liste des informations importantes pour la prévision de la chimie des eaux de drainage**

Ce chapitre fournit une liste détaillée des informations importantes pour la prévision de la chimie des eaux de drainage des matériaux sulfurés. Cette liste se veut un moyen de faire connaître les enjeux d'ordre général au technicien spécialisé, et les besoins en informations détaillées au généraliste. Chaque site minier présente un amalgame unique de conditions environnementales, géologiques et opérationnelles. Peu importe le site, des propriétés et des processus inscrits dans cette liste ne s'appliqueront pas. Par contre, dans certains cas, il faudra ajouter des facteurs à la liste. Pour minimiser les risques pour l'environnement et la responsabilité financière, il faut entre autres tenir compte des conditions de quasi neutralité et d'alcalinité ainsi que du drainage acide et de la réduction de l'eau ou de l'oxygène pénétrant dans l'élément du projet. À chaque étape de la prévision, il faut examiner le but de l'essai et déterminer si les résultats auront un impact sur la gestion du site, la responsabilité financière ou le risque pour l'environnement. Dans certains cas, la mise en oeuvre de mesures d'atténuation des contingences parallèlement à des essais opérationnels durant l'exploitation de la mine seront plus efficaces que la réalisation d'essais provisoires avant l'exploitation de la mine, car ces derniers peuvent s'avérer non concluants ou encore peu pertinents étant donné le plan de la mine. Dans tous les cas, le savoir n'est jamais complet. Donc, toute prévision de la chimie des eaux de drainage doit comporter l'identification et la prise en charge de l'imprévisibilité.

## ACKNOWLEDGEMENTS

The following persons and organizations are thanked for their contributions during the preparation of this document, although this should not be construed as an endorsement in whole or in part.

Financial support was provided by The Mining Association of Canada (MAC), CANMET-Mining and Mineral Sciences Laboratories (Natural Resources Canada), British Columbia Ministry of Energy, Mines and Petroleum Resources / British Columbia Technical Research Committee on Reclamation, International Network for Acid Prevention (INAP), Ontario Ministry of Northern Development, Mines and Forestry, Yukon Mining and Petroleum Environment Research Group, and MEND.

Major technical assistance was provided by Kevin Morin (Mine Drainage Assessment Group). David Koren and Irene Lafferty (Natural Resources Canada) and Kevin Morin provided major editorial assistance. Technical assistance was also provided by Mike Aziz (Goldcorp Canada Ltd.), Kim Bellefontaine (BC MEMPR), Scott Davidson (formerly Kemess Mine), Stephen Day (SRK Consulting (Canada) Inc.), Glenda Ferris, Diane Howe (BC MEMPR), Nora Hutt (Mine Drainage Assessment Group), John Jambor<sup>†</sup> (Leslie Research and Consulting), Bruce Mattson (Lorax Environmental Services Ltd.), Peri Mehling (formerly MESH Environmental Inc.), Tim O'Hearn (Cantest Ltd.), Leslie Smith (University of British Columbia), Anne Thompson (PetraScience Consultants Inc.) and Shannon Shaw (formerly MESH Environmental Inc.).

The following persons are thanked for their review of specific chapters.

- |           |   |
|-----------|---|
| Chapter 1 | Wade Stogran (North American Tungsten Corporation Ltd.)   |
| Chapter 2 | Stephen Day (SRK Consulting (Canada) Inc.) and Wade Stogran (North American Tungsten Corporation Ltd.)  |
| Chapter 3 | Stephen Day (SRK Consulting (Canada) Inc.), Rob McCandless (formerly Environment Canada) and Wade Stogran (North American Tungsten Corporation Ltd.)  |
| Chapter 4 | Stephen Day (SRK Consulting (Canada) Inc.), Keith Ferguson (Sustainability Engineering), Rob McCandless (formerly Environment Canada) and Wade Stogran (North American Tungsten Corporation Ltd.) |
| Chapter 5 | Stephen Day (SRK Consulting (Canada) Inc.) and Rob McCandless (formerly Environment Canada)   |
| Chapter 6 | Rob McCandless (formerly Environment Canada)  |
| Chapter 7 | Rob McCandless (formerly Environment Canada) and Leslie Smith (University of British Columbia)  |
| Chapter 8 | Tim O'Hearn (Cantest Ltd.) and Wade Stogran (North American Tungsten Corporation Ltd.)  |

- Chapter 9 Mike Aziz (Goldcorp Canada Ltd.), Kim Lapakko (Minnesota Department of Natural Resources), Tim O'Hearn (Cantest Ltd.) and Wade Stogran (North American Tungsten Corporation Ltd.)
- Chapter 10 Alan Martin (Lorax Environmental Services Ltd.) and Tim O'Hearn (Cantest Ltd.)
- Chapter 11 Tim O'Hearn (Cantest Ltd.)
- Chapter 12 Tim O'Hearn (Cantest Ltd.) and Wade Stogran (North American Tungsten Corporation Ltd.)
- Chapter 13 Rick Lawrence (BioteQ Environmental Technologies Inc.), Bruce Mattson (Lorax Environmental Services Ltd.), Rob McCandless (formerly Environment Canada) and Tim O'Hearn (Cantest Ltd.)
- Chapter 14 Mike Aziz (Goldcorp Canada Ltd.), Keith Ferguson (Sustainability Engineering), Rob McCandless (Environment Canada) and Tim O'Hearn (Cantest Ltd.)
- Chapter 15 Tim O'Hearn (Cantest Ltd.) and Shannon Shaw (formerly MESH Environmental Inc.)
- Chapter 16 Tim O'Hearn (Cantest Ltd.)
- Chapter 17 Heather Jamieson (Queen's University), Bruce Mattson (Lorax Environmental Services Ltd.), Tim O'Hearn (Cantest Ltd.) and Mati Raudsepp (University of British Columbia)
- Chapter 18 Tim O'Hearn (Cantest Ltd.)
- Chapter 19 Tim O'Hearn (Cantest Ltd.)
- Chapter 20 Andrew Rollo (Lorax Environmental Services Ltd.) and Rob McCandless (formerly Environment Canada)
- Chapter 21 Keith Ferguson (Sustainability Engineering)
- Glossary: Kim Bellefontaine (BC MEMPR), Iain Bruce (BGC Engineering Inc.), Gordon Ford (formerly BC Ministry of Environment), John Kwong (Natural Resources Canada), Kim Lapakko (Minnesota Department of Natural Resources), Chris Mills<sup>†</sup>, and Leslie Smith (University of British Columbia).

This document would also not be possible without the general support provided by Rebecca Chouinard (formerly Indian and Northern Affairs Canada), Elizabeth Gardiner (The Mining Association of Canada), Walter Kuit (TeckCominco), Sharon Rowsome (Natural Resources Canada), Charlene Hogan and Gilles Tremblay (MEND Secretariat).

## TABLE OF CONTENTS

PREAMBLE.....	PA-1
NAVIGATING THIS MANUAL .....	PA-2
FLOWCHART OF CHAPTERS.....	PA-3
SUMMARY OF SOME IMPORTANT POINTS IN EACH CHAPTER.....	PA-4
PRÉFACE .....	PA-12
CONSULTATION DE CE MANUEL .....	PA-13
SCHÉMA DES CHAPITRES .....	PA-14
RÉSUMÉ DE QUELQUES POINTS IMPORTANTS DE CHACUN DES CHAPITRES .....	PA-15
ACKNOWLEDGEMENTS .....	PA-24
TABLE OF CONTENTS.....	PA-26
LIST OF TABLES .....	PA-38
LIST OF FIGURES .....	PA-40
1.0 INTRODUCTION.....	1-1
1.1 Rationale .....	1-1
1.2 The Source of Poor Quality Drainage Chemistry from Sulphidic Rock .....	1-2
1.3 Objectives of this Manual .....	1-3
1.4 Layout of this Manual.....	1-4
1.5 Guideline Development .....	1-4
1.6 References.....	1-5
2.0 OVERALL OBJECTIVES OF PREDICTION.....	2-1
3.0 GENERAL PRINCIPLES AND BEST PRACTICES.....	3-1
3.1 Take a Site Specific Approach.....	3-1
3.2 Predict the Drainage Chemistry of All Geologic Materials and Project Components .....	3-2
3.3 Consider All Potentially Influential Properties and Processes .....	3-4
3.4 Be Proactive.....	3-5
3.5 Demonstrate Necessary Understanding, Capability, Resources and Intent.....	3-6
3.6 Consider the Range and Variability in Properties and Processes .....	3-6
3.7 Consider All Elements, Minerals and Drainage pH Ranges.....	3-8
3.8 Consider Temporal Changes in Properties and Processes Controlling Drainage Chemistry.....	3-8
3.9 Predict Drainage Chemistry throughout the Life of a Project .....	3-12
3.10 Continue Prediction if there is Significant Uncertainty.....	3-13
3.11 Consider the Impact of the Project as a Whole.....	3-14
3.12 Take a Scientific Approach.....	3-15
3.13 Deal with Uncertainty and Gaps in the Prediction Data .....	3-16
3.14 Be Prepared for Changes to the Mine Plan.....	3-20
3.15 Clearly Identify Materials and Methods .....	3-20
3.16 Use Clearly Defined Terminology.....	3-20
3.17 Identify the Intended Uses of Prediction Analyses and Test Work.....	3-21
3.18 Consider the Cost-effectiveness of Additional Test Work .....	3-22
3.19 Use a Phased Approach .....	3-23
3.20 Get Started as Soon as Possible .....	3-23

3.21	Avoid Past Errors.....	3-24
3.22	Use Properly Qualified and Responsible Personnel .....	3-26
3.23	Provide Adequate Personnel and Resources.....	3-26
3.24	Maintain a Data Base of Materials, Methods, Results and Relevant Properties of the Project and Site .....	3-28
3.25	Be Prepared to Act on the Prediction Results.....	3-30
3.26	Act Safely.....	3-30
3.27	Review the Details of the Sample Results and Materials and Methods .....	3-30
3.28	References.....	3-31
4.0	MAIN STEPS AND STAGES OF A PREDICTION PROGRAM.....	4-1
4.1	Step 1 – Review General Properties of the Project and Site.....	4-1
4.2	Step 2 – Measure Existing Drainage Chemistry, If any, and Predict Potential Future Drainage Chemistry .....	4-2
4.2.1	Properties and Processes Potentially Affecting Drainage Chemistry.....	4-2
4.2.2	Materials to Analyze and Test .....	4-3
4.2.3	Analyses and Test Procedures .....	4-4
4.2.4	Measures of the Present Composition of Materials at the Site (Static Tests).....	4-6
4.2.5	Measures of Reaction Rates and Changes in Drainage Chemistry (Kinetic Data) ...	4-8
4.3	Step 3 – Verify the Predicted Compositions of the Materials and Drainage Chemistry and Address Significant Information Gaps.....	4-8
4.3.1	Operational Material Characterization.....	4-8
4.3.2	Monitoring Weathering, Drainage Conditions, Drainage Chemistry and Residual Effects .....	4-9
4.3.3	Follow-Up Studies to Address Information Gaps.....	4-9
4.4	Prediction During Different Stages of Project Development .....	4-10
4.4.1	Minimum Mass of Material Requiring Prediction.....	4-11
4.4.2	Exploration.....	4-12
4.4.3	Feasibility Studies and Project Planning.....	4-13
4.4.4	Construction, Mining and Processing.....	4-14
4.4.5	Closure Planning.....	4-16
4.4.6	After Mine Closure .....	4-19
4.4.7	Omissions and Errors in Previous Stages of the Project.....	4-20
4.5	References.....	4-21
5.0	PARAMETERS AND PROCESSES CONTROLLING DRAINAGE CHEMISTRY...5-1	
5.1	Introduction.....	5-1
5.1.1	Geologic Materials.....	5-2
5.1.2	Exposure of Sulphidic Geologic Materials.....	5-4
5.1.3	Elements of Concern.....	5-4
5.1.4	Metal Leaching and Acid Rock Drainage.....	5-5
5.1.5	Acid, pH, Acidity and Alkalinity.....	5-6
5.2	Weathering Processes and Reactions.....	5-8
5.2.1	Physical Changes Resulting from Weathering .....	5-9
5.2.2	Dissolution and Precipitation.....	5-10
5.2.3	Oxidation and Reduction (Redox) .....	5-13
5.2.4	Galvanic Effects.....	5-17
5.2.5	Hydration and Dehydration.....	5-18

5.2.6	Hydrolysis .....	5-18
5.2.7	Ion Exchange .....	5-19
5.2.8	Microbial Action .....	5-19
5.2.9	Mineral Alteration by a Combination of Weathering Reactions .....	5-20
5.2.10	Rate of Weathering .....	5-21
5.3	Sulphur Species .....	5-21
5.3.1	Sulphide Minerals .....	5-22
5.3.2	Dissolved Sulphur .....	5-25
5.3.3	Sulphate Minerals .....	5-26
5.3.3.1	Calcium Sulphate Minerals .....	5-28
5.3.3.2	Iron Sulphate Minerals .....	5-29
5.3.3.3	Aluminum Sulphate Minerals .....	5-30
5.3.3.4	Barite (BaSO <sub>4</sub> ) and Celestite (SrSO <sub>4</sub> ) .....	5-30
5.3.3.5	Other Sulphate Minerals .....	5-31
5.4	Sulphide Oxidation .....	5-31
5.4.1	Different Aspects of the Sulphide Oxidation Reaction .....	5-31
5.4.2	Products of Sulphide Oxidation .....	5-34
5.4.3	Products of the Oxidation of Iron Sulphide Minerals .....	5-34
5.4.4	Products of Oxidation of Trace Element Sulphide Minerals .....	5-35
5.5	Acidity from Dissolution of Acidic Sulphate Minerals .....	5-37
5.5.1	Displacement of Acidity on Exchange Sites .....	5-38
5.6	Acid Neutralization and Production of Net Acidic Drainage .....	5-38
5.6.1	Neutralization by Carbonate Minerals .....	5-39
5.6.2	Neutralization by Aluminum and Iron Oxyhydroxides .....	5-41
5.6.3	Neutralization by Silicate and Aluminosilicate Minerals .....	5-42
5.7	Other Properties and Processes that Control Weathering Reaction Rates and Drainage Chemistry .....	5-44
5.7.1	Size, Surface Area and Arrangement of Particles .....	5-44
5.7.2	Mineral Surface Area .....	5-46
5.7.3	Hydraulic Properties and Drainage Conditions .....	5-47
5.7.4	Atmospheric Properties and Processes .....	5-50
5.7.5	Temperature .....	5-53
5.8	Drainage Chemistry from Sulphidic Geologic Materials .....	5-56
5.8.1	Dependency of Metal Solubility on pH .....	5-57
5.8.2	Iron .....	5-57
5.8.3	Aluminum .....	5-57
5.8.4	Barium .....	5-58
5.8.5	Strontium .....	5-58
5.8.6	Cadmium, Zinc and Nickel .....	5-58
5.8.7	Lead .....	5-58
5.8.8	Manganese .....	5-58
5.9	References .....	5-58
6.0	SITE CONDITIONS .....	6-1
6.1	Introduction .....	6-1
6.2	Geography and Baseline Conditions .....	6-1
6.3	Climate .....	6-3



6.4	Hydrology and Hydrogeology of the Site.....	6-4
6.5	Regulatory, Community and Corporate Needs for Environmental Protection and Reclamation .....	6-6
6.6	Geology.....	6-7
6.6.1	Genesis of Bedrock and Soils .....	6-7
6.6.2	Influence of Genesis on the Spatial Distribution of Key Properties.....	6-8
6.6.3	Geo-Environmental Models of Mineral Deposits.....	6-9
6.6.4	Differentiation and Description of Geological Units.....	6-9
6.6.5	Description of Soil and Other Non-Lithified Overburden.....	6-13
6.6.6	Description of the Geologic Material in Existing Project Components .....	6-13
6.6.7	Geological Mapping.....	6-13
6.7	References.....	6-14
7.0	THE PROJECT AND PROJECT COMPONENTS .....	7-1
7.1	Introduction.....	7-1
7.2	Excavations: Open Pits and Underground Workings .....	7-4
7.2.1	Mine Walls and the Associated Fractures and Talus .....	7-5
7.2.2	Backfill.....	7-6
7.2.3	Other Materials .....	7-7
7.2.4	Hydraulic Properties and Drainage Conditions .....	7-8
7.2.5	Atmospheric Parameters and Processes.....	7-9
7.3	Waste Materials .....	7-10
7.4	Waste Rock .....	7-12
7.4.1	Particle Size .....	7-12
7.4.2	Particle and Mineral Surface Area Exposed to Weathering .....	7-13
7.4.3	Differences between the Geochemistry of the Fine and Coarse Sized Particles .....	7-14
7.4.4	Dump Construction and the Resulting Structural Features.....	7-14
7.4.5	Particle Breakdown and Migration after Dump Construction .....	7-16
7.4.6	Hydrologic Properties and Drainage Conditions .....	7-17
7.4.7	Atmospheric Properties and Processes .....	7-19
7.4.8	Weathering and Contaminant Migration .....	7-20
7.5	Milling or Processing Wastes .....	7-21
7.5.1	Reducing the Particle Size .....	7-22
7.5.2	Processing Coal.....	7-22
7.5.3	Processing Ore .....	7-23
7.5.4	Properties of Processing Wastes .....	7-24
7.6	Tailings .....	7-25
7.6.1	Particle Size and Geochemical Composition.....	7-25
7.6.2	Process Water.....	7-26
7.6.3	Deposition and Reprocessing of Tailings .....	7-27
7.6.4	Drainage and Atmospheric Properties and Processes.....	7-29
7.6.5	Weathering and Contaminant Migration .....	7-31
7.7	Stockpiles of Ore and Low Grade Ore.....	7-33
7.8	Wastes and Sediment from Drainage Collection and Treatment.....	7-34
7.9	Other Sulphidic Materials.....	7-37
7.10	Co-Disposal of Different Waste Materials and Drainages .....	7-37
7.11	Prediction Guidelines for Project Components.....	7-39

7.11.1	General Properties and Processes of a Project.....	7-40
7.11.2	Physical Properties and Processes .....	7-41
7.11.3	Hydraulic Properties and Drainage Conditions .....	7-41
7.11.4	Atmospheric Properties and Processes .....	7-43
7.11.5	Geochemical Properties and Processes.....	7-45
7.11.6	Conceptual Models of the Project, Site and Project Components .....	7-46
7.11.7	Additional Prediction Guidelines for Excavations .....	7-49
7.11.7.1	Prediction Prior to Excavation.....	7-50
7.11.7.2	Prediction during Excavation.....	7-50
7.11.7.3	Prediction for Closure Planning and After Closure .....	7-51
7.11.7.4	Dealing with Uncertainty .....	7-53
7.11.7.5	Prediction Errors .....	7-54
7.11.8	Additional Prediction Guidelines for Waste Rock and Waste Rock Dumps.....	7-54
7.11.8.1	Materials Used for Analysis and Test Work.....	7-56
7.11.8.2	Prediction Prior to Mining .....	7-56
7.11.8.3	Prediction from Analysis and Test Work on Samples .....	7-57
7.11.8.4	Analysis of Blast Hole Cuttings.....	7-58
7.11.8.5	Prediction during Waste Rock Excavation and Dump Construction.....	7-59
7.11.8.6	Prediction after Dump Construction .....	7-60
7.11.8.7	Dealing with Uncertainty.....	7-62
7.11.9	Additional Prediction Guidelines for Tailings.....	7-63
7.11.9.1	Prediction Prior to Processing.....	7-65
7.11.9.2	Prediction during Processing and Deposition .....	7-65
7.11.9.3	Prediction after Deposition .....	7-66
7.11.9.4	Desulphurized Tailings .....	7-67
7.11.9.5	Prediction Errors .....	7-67
7.11.10	Additional Prediction Guidelines for Ore and Low Grade Ore .....	7-68
7.11.11	Additional Prediction Guidelines for Wastes and Sediment from Drainage Collection and Treatment.....	7-68
7.11.12	Additional Prediction Guidelines for Other Sulphidic Materials .....	7-69
7.11.13	Additional Prediction Guidelines for Co-Disposed Wastes.....	7-69
7.12	References.....	7-69
8.0	SELECTION, STORAGE AND PREPARATION OF SAMPLES .....	8-1
8.1	Introduction.....	8-1
8.2	Which Material to Sample .....	8-2
8.3	Where, When and How Frequently to Sample .....	8-3
8.4	Dimensions to Sample .....	8-8
8.5	Sample Mass .....	8-9
8.6	Sample Description.....	8-10
8.7	Storage and Preparation of a Solid Sample.....	8-11
8.8	Use of Samples Collected for Other Purposes.....	8-12
8.9	Particle Size and Exposed Surface Effects .....	8-13
8.10	Weathering and Leaching Features.....	8-16
8.10.1	Colour .....	8-17
8.10.2	Natural Outcrops and Non-Lithified Surficial Materials .....	8-20
8.11	Pre-Development .....	8-21

8.11.1	Selection of Material to Sample.....	8-21
8.11.2	Where, When and How Frequently to Sample .....	8-21
8.11.3	Dimensions to Sample .....	8-22
8.12	Blast Hole Cuttings.....	8-22
8.13	Excavations.....	8-24
8.13.1	Sampling Backfill and Residual Blasted Rock.....	8-24
8.13.2	Operational Sampling of Final Walls and Resulting Fractures and Talus.....	8-25
8.13.3	Sampling after Construction of the Excavations .....	8-25
8.14	Post-Blast Waste Rock.....	8-25
8.14.1	Sampling during Excavation.....	8-26
8.14.2	Sampling after Dump Construction .....	8-27
8.15	Tailings and Other Processing and Treatment Wastes .....	8-28
8.15.1	Sampling during Processing, Treatment and Deposition of the Resulting Wastes.....	8-28
8.15.2	Sampling after Closure of Processing Facilities .....	8-29
8.16	Safety .....	8-30
8.17	References.....	8-31
9.0	OVERVIEW OF STATIC AND KINETIC TESTS.....	9-1
9.1	Introduction.....	9-1
9.2	Static Tests.....	9-2
9.3	Kinetic Tests .....	9-9
9.3.1	Generic Information Requirements.....	9-10
9.3.2	Pre-Test Characterization of the Project Component .....	9-10
9.3.3	Selection of Kinetic Tests.....	9-13
9.3.4	Pre-Test Characterization of the Test Material .....	9-14
9.3.5	Monitoring during the Test.....	9-15
9.3.6	Post-Test Characterization of the Test Material .....	9-16
9.4	References.....	9-16
10.0	WHOLE-ROCK AND NEAR-TOTAL SOLID PHASE ELEMENTAL ANALYSIS	10-1
10.1	Introduction.....	10-1
10.2	Objectives .....	10-1
10.2.1	Limitations .....	10-2
10.2.2	Overview of the Methods.....	10-2
10.3	Methods of Sample Digestion.....	10-3
10.3.1	Lithium Borate Fusion .....	10-4
10.3.2	Sodium Peroxide Fusion.....	10-5
10.3.3	Four Acid Method.....	10-5
10.3.4	Three Acid Method.....	10-6
10.3.5	Aqua Regia.....	10-6
10.4	Methods of Analysis .....	10-6
10.4.1	X-ray Fluorescence Spectroscopy (XRF).....	10-6
10.4.2	Field Portable and Hand Held XRF Instruments .....	10-7
10.4.3	Inductively Coupled Plasma .....	10-8
10.4.4	Inductively Coupled Plasma Atomic Emission Spectroscopy (ICP-AES).....	10-8
10.4.5	Inductively Coupled Plasma Mass Spectroscopy (ICP-MS) .....	10-9
10.4.6	Atomic Absorption Spectroscopy (AAS) .....	10-10

10.4.7	Neutron Activation.....	10-10
10.5	Other Analytical Methods.....	10-10
10.6	Reporting of Results as Oxide Equivalents .....	10-11
10.7	Use of the Results .....	10-11
10.7.1	Compare with Concentrations in Non-Mineralized Rock and Soil .....	10-11
10.7.2	Calculate Depletion Times and Duration of Leaching .....	10-11
10.7.3	Estimate the Concentrations of Different Minerals .....	10-12
10.7.4	Estimate Maximum Potential Concentration of Acid Insoluble Sulphate .....	10-12
10.7.5	Estimate the Type and Concentration of Non-Iron Sulphide Minerals .....	10-13
10.7.6	Identification of Anomalous Geochemical Conditions.....	10-13
10.8	Detection Limits.....	10-14
10.9	Recommended Methods.....	10-14
10.10	Recipes.....	10-16
10.10.1	Elemental Analysis .....	10-16
10.10.2	Lithium Tetraborate Fusion Digestion / XRF or ICP Analysis .....	10-16
10.10.3	Pressed Pellet / XRF Analysis .....	10-16
10.10.4	Four Acid Digestion / ICP Analysis .....	10-16
10.10.5	Aqua Regia Digestion / ICP Analysis.....	10-16
10.11	Summary of Key Considerations.....	10-17
10.12	References.....	10-17
11.0	ANALYSIS OF SOLUBLE CONSTITUENTS .....	11-1
11.1	Introduction.....	11-1
11.1.1	Soluble Constituents .....	11-1
11.1.2	Measurement Objectives.....	11-2
11.1.3	When to Analyze Soluble Constituents .....	11-3
11.1.4	Measurements of Soluble Constituents.....	11-4
11.2	Analytical Methods for Soluble Constituents.....	11-4
11.2.1	Pretreatment and Particle Size to Use in the Analysis.....	11-5
11.2.2	Leach Water to Use in the Analysis.....	11-6
11.3	Leach Water Chemistry .....	11-6
11.3.1	Weight of Sample and Ratio of Water to Solid Phase .....	11-7
11.4	Pre-Test Characterization of the Solid Phase Test Material .....	11-8
11.5	Shake Flask Test .....	11-8
11.6	pH Analysis.....	11-10
11.6.1	Abrasion pH.....	11-10
11.6.2	Methods of Sample Preparation.....	11-11
11.6.2.1	Crushed Sample pH .....	11-12
11.6.2.2	Surface Rinse pH .....	11-12
11.6.3	Electrode Measurement of pH .....	11-12
11.6.4	Near-Saturation Paste pH Analysis.....	11-13
11.6.5	1:1 Surface Rinse and Crushed Sample pH Analysis .....	11-14
11.7	Conclusions.....	11-15
11.8	References.....	11-15
12.0	SULPHUR SPECIES AND ACID GENERATION POTENTIAL (AP) .....	12-1
12.1	Introduction.....	12-1
12.1.1	Sulphur Species.....	12-1

12.1.1.1	Sulphide Sulphur.....	12-2
12.1.1.2	Sulphate Sulphur.....	12-2
12.1.1.3	Other Sulphur Species.....	12-3
12.1.2	Objectives .....	12-3
12.1.3	Overview of Methods .....	12-5
12.2	Methods of Geological and Mineralogical Analysis .....	12-6
12.3	Methods of Pyrolysis or Roasting .....	12-6
12.3.1	High Temperature Furnace .....	12-6
12.3.1.1	Leco Induction Furnace and Automatic Sulphur Titrator .....	12-7
12.3.2	Pyrolysis at 550°C.....	12-8
12.4	Methods of Wet Chemical Extraction.....	12-9
12.4.1	Water.....	12-11
12.4.2	Hydrochloric Acid .....	12-12
12.4.2.1	EPA-600 – Hydrochloric Acid Method .....	12-13
12.4.2.2	ASTM E 1915 – Hot Hydrochloric Acid Method.....	12-15
12.4.2.3	Soluble and Volatile Sulphur Extraction under Anoxic Conditions with Hot Hydrochloric Acid .....	12-15
12.4.2.4	Soluble and Volatile Sulphur Extraction under Anoxic Conditions with Hot Hydrochloric Acid / Chromium Chloride .....	12-18
12.4.2.5	Pyrolysis at 550°C Followed by Hydrochloric Acid Extraction.....	12-19
12.4.3	Hot Sodium Carbonate.....	12-22
12.4.4	Nitric Acid .....	12-22
12.4.4.1	EPA-600 Method – Nitric Acid Method.....	12-23
12.4.4.2	ASTM E 1915 – Nitric Acid Method.....	12-24
12.5	Calculations from Results of Solid Phase Elemental Analysis.....	12-25
12.6	Recommended Approaches for Measurement of Sulphur Species.....	12-25
12.6.1	Initial Assessment of Sulphur Species and Selection of Analyses .....	12-25
12.6.2	Total Sulphur .....	12-26
12.6.3	Sulphide-Sulphur .....	12-26
12.6.4	Different Sulphide Species .....	12-28
12.6.4.1	Calculations of Trace Element Sulphide-Sulphur from Solid Phase Elemental Analysis.....	12-28
12.6.4.2	Mineralogical Analysis .....	12-29
12.6.4.3	Selective Extraction .....	12-29
12.6.5	Sulphate Fractions and Species.....	12-30
12.6.6	Highly Soluble Basic and Acidic Sulphates .....	12-31
12.6.7	Moderately Soluble Basic Sulphates .....	12-31
12.6.8	Low Solubility Acidic Sulphates .....	12-32
12.6.9	Extremely Insoluble Sulphate Minerals.....	12-32
12.6.9.1	Calculations from Results of Solid-Phase Elemental Analysis .....	12-33
12.6.9.2	Sub-microscopic Analysis of % Ba and Pb in Different Minerals .....	12-33
12.7	Acid Generation Potential.....	12-34
12.7.1	Sources of Acid.....	12-35
12.7.2	Estimation of Acid Potential in Acidic Sulphate Minerals.....	12-36
12.7.2.1	Conditions that Reduce Acid Generation.....	12-37
12.7.2.2	Analyses.....	12-37

12.7.3	Acid Generated by Sulphide Oxidation .....	12-37
12.7.3.1	Acid Generation by Non-Iron Sulphide Species Generating Metal Cations 12-38	
12.7.3.2	Acid Generation by Non-Iron Sulphide Species Generating Anions .....	12-39
12.7.3.3	Preliminary Assessment of Impact of Non-Iron Sulphide on the Acid Potential .....	12-39
12.7.3.4	More Refined Assessment of Impact of Non-Iron Sulphide on the Acid Potential .....	12-40
12.7.4	Correction for Differences between Effective Field and Measured AP .....	12-40
12.7.4.1	Concentration during Tailings Deposition.....	12-40
12.7.4.2	Physical Occlusion.....	12-41
12.7.4.3	Weathering and Leaching Conditions.....	12-41
12.7.4.4	Precipitation of Acidic Sulphate Minerals.....	12-42
12.7.4.5	Slow Reaction Rates .....	12-42
12.8	References.....	12-42
13.0	ACID NEUTRALIZATION POTENTIAL (NP) .....	13-1
13.1	Introduction.....	13-1
13.1.1	Factors Affecting Acid Neutralization Potential.....	13-3
13.1.2	Minerals that Contribute to Acid Neutralization .....	13-3
13.1.2.1	Carbonate Minerals.....	13-4
13.1.2.2	Aluminum and Iron Hydroxides and Oxides .....	13-4
13.1.2.3	Silicate Minerals .....	13-4
13.1.3	Site and Material Specific Properties and Processes .....	13-5
13.1.4	Methods of Analysis .....	13-5
13.1.5	Differences Between Analytical Results and the Effective NP in the Field.....	13-6
13.2	Carbonate Neutralization Potential .....	13-8
13.2.1	Methods.....	13-8
13.2.2	Discussion.....	13-9
13.3	Bulk Neutralization Potential Analyses .....	13-10
13.3.1	Introduction.....	13-10
13.3.2	Sobek NP Procedure .....	13-11
13.3.3	1996 Modified NP Procedure .....	13-15
13.3.4	Comparison of Sobek and Modified Procedures .....	13-16
13.3.5	Other Bulk NP Methods.....	13-18
13.3.6	Data Interpretation .....	13-19
13.3.6.1	Aluminosilicate NP .....	13-19
13.3.6.2	Fe-Mn Carbonate Minerals .....	13-20
13.3.6.3	Plot CO <sub>3</sub> -NP versus Bulk NP.....	13-21
13.4	Conclusions.....	13-21
13.5	References.....	13-23
14.0	ACID BASE ACCOUNTING AND CRITERIA USED TO PREDICT POTENTIAL FOR ACIDIC DRAINAGE .....	14-1
14.1	Introduction.....	14-2
14.1.1	Acid Base Accounting and the Prediction of Drainage pH .....	14-2
14.1.2	Categories of Net Current and Potential Future Drainage pH .....	14-3
14.1.3	Net Neutralization Potential (NNP) and Neutralization Potential Ratio (NPR) 14-4	

14.2	Criteria Used in the Prediction of Acidic Drainage.....	14-8
14.2.1	ABA Criteria for Determining Whether Material Will Produce Acidic Drainage and Segregating PAG and Non-PAG Material.....	14-8
14.2.2	Minimum % S Capable of Causing ARD.....	14-13
14.2.3	Maximum Length of Time for ARD to Occur.....	14-15
14.2.4	Conclusions Regarding Acidic Drainage Criteria.....	14-15
14.3	References.....	14-16
15.0	NAG TESTS.....	15-1
15.1	Introduction.....	15-1
15.2	Single Addition NAG Test.....	15-2
15.2.1	Method.....	15-2
15.2.2	Discussion of the Method.....	15-4
15.2.3	Comparison of Single Addition NAG Test with NAG-NNP Results.....	15-5
15.3	Sequential NAG Test.....	15-6
15.4	Kinetic NAG Test.....	15-6
15.5	Acid Buffering Characteristic Curve (ABCC) Test.....	15-7
15.6	Different Terms and Conventions Used in Australasia.....	15-8
15.7	References.....	15-8
16.0	PARTICLE SIZE SEPARATION AND ANALYSIS.....	16-1
16.1	Introduction.....	16-1
16.1.1	Methods of Analysis.....	16-2
16.2	Separation of Soil, Gravel and Stone Size Fractions.....	16-3
16.3	A More Refined Particle Size Separation for Surface Area Determinations.....	16-5
16.4	Calculation or Measurement of Particle Surface Area.....	16-5
16.5	References.....	16-6
17.0	MINERALOGICAL PROPERTIES.....	17-1
17.1	Introduction.....	17-1
17.1.1	Use in Selection, Design and Interpretation of Other Analyses and Tests.....	17-3
17.1.2	Limitations.....	17-5
17.1.3	Overview of Methods.....	17-6
17.2	Visual Description.....	17-6
17.3	Petrographic Microscope.....	17-8
17.3.1	Objectives.....	17-8
17.3.2	Sample Preparation.....	17-9
17.3.3	Mineralogical Analysis.....	17-10
17.3.4	Limitations.....	17-12
17.4	X-ray Diffraction.....	17-12
17.4.1	General Methodology for XRD.....	17-13
17.4.2	Rietveld Analysis of Powder XRD Data.....	17-14
17.4.3	Limitations.....	17-15
17.5	Scanning Electron Microscope and Energy Dispersive X-ray Spectrometer.....	17-16
17.6	Electron Microprobe.....	17-19
17.7	Laser Ablation and Other Microbeam Analyses.....	17-20
17.8	Image Analysis.....	17-21
17.9	Calculation of Mineral Concentrations from Elemental Data.....	17-22

17.10	Recommended Methods and Samples .....	17-23
17.11	Discussion .....	17-24
17.12	References .....	17-25
18.0	HUMIDITY CELL PROCEDURES .....	18-1
18.1	Introduction .....	18-1
18.1.1	Advantages of the Humidity Cell .....	18-1
18.1.2	Simulated Weathering in a Humidity Cell versus Weathering in the Field .....	18-2
18.2	Humidity Cell Procedure .....	18-2
18.2.1	Apparatus .....	18-3
18.2.2	General Outline of the Procedure .....	18-3
18.2.3	Sample Preparation .....	18-6
18.2.4	Humidity Cell Startup Procedure .....	18-7
18.2.4.1	Procedures for Week 0 .....	18-7
18.2.4.2	QA/QC Procedures for Week 0 .....	18-9
18.2.5	Humidity Cell Weekly Operating Procedure .....	18-9
18.2.5.1	QA/QC Procedures for Weekly Operation .....	18-11
18.2.6	Humidity Cell Closedown Procedure .....	18-11
18.3	Interpretation of Humidity Cell Tests .....	18-12
18.4	References .....	18-19
19.0	KINETIC TESTS THAT MEASURE PRIMARY MINERAL WEATHERING AND SECONDARY MINERAL PRECIPITATION AND DISSOLUTION .....	19-1
19.1	Introduction .....	19-1
19.1.1	Selection of Tests and Interpretation of the Results .....	19-2
19.1.2	Design of the Test .....	19-2
19.2	Trickle Leach Columns .....	19-3
19.3	Field Test Cells .....	19-8
19.3.1	Introduction .....	19-8
19.3.2	Procedure for On-Site Kinetic Tests using Barrels or “Cubes” .....	19-10
19.4	Wall Washing Stations .....	19-12
19.5	On-Site Monitoring of Mine Components and the Resulting Drainage .....	19-14
19.6	Interpretation Results from On-Site Kinetic Data .....	19-16
19.7	Examining Previously Weathered Materials .....	19-18
19.8	References .....	19-19
20.0	MODELING DRAINAGE CHEMISTRY .....	20-1
20.1	Empirical Modeling .....	20-2
20.2	Speciation and Mineral Equilibrium Modeling .....	20-5
20.3	More Complex Models .....	20-6
20.4	References .....	20-7
21.0	CHECKLIST OF IMPORTANT INFORMATION FOR THE PREDICTION OF DRAINAGE CHEMISTRY .....	21-1
21.1	Introduction .....	21-1
21.2	General Information Requirements .....	21-2
21.3	Material Characterization and Drainage Chemistry Prediction .....	21-3
21.4	Geology and Mineralogy .....	21-3
21.4.1	Geological Properties .....	21-3



21.4.2	Mineralogy .....	21-4
21.5	Sample Selection, Storage and Preparation .....	21-5
21.6	Static Tests: Measurement of Material Composition.....	21-6
21.6.1	Elemental Analysis .....	21-6
21.6.2	Acid Base Accounting .....	21-7
21.7	Kinetic Tests: Measurement of Reaction Rates and Drainage Chemistry.....	21-8
21.7.1	Humidity Cell.....	21-9
21.7.2	Kinetic Tests that Measure Primary Mineral Weathering and Secondary Mineral Precipitation and Dissolution.....	21-10
21.8	Assessment of Different Waste Materials and Site Components .....	21-10
21.8.1	Waste Rock and Waste Rock Dumps .....	21-11
21.8.2	Tailings .....	21-11
21.8.3	Mine Workings – Open Pits and Underground Mine .....	21-12
21.9	Interpretation of Geochemical Results.....	21-12
21.9.1	General Considerations.....	21-12
21.9.2	Identifying Potentially ARD Generating Materials .....	21-13
21.9.3	Identifying Non-Potentially ARD Generating Materials.....	21-13
21.9.4	Predicted Drainage Chemistry and Metal Loading.....	21-14
21.9.5	Time to Onset of ARD.....	21-14
21.10	Prediction Information Requirements for Mitigation Measures.....	21-15
21.11	Flooding of Mine Wastes and Workings .....	21-15
21.11.1	Flooded Wastes.....	21-15
21.11.2	Delay in Flooding .....	21-16
21.11.3	Incomplete Flooding.....	21-16
21.11.4	Chemistry of Water Cover and Impoundment Discharge.....	21-16
21.12	Measures to Reduce Infiltration of Drainage and/or Entry of Oxygen.....	21-17
21.12.1	Overall Mitigation Objectives for Drainage Chemistry.....	21-17
21.12.2	Resulting Performance of Contaminant Source.....	21-17
21.13	Drainage Treatment .....	21-17
21.14	Addition of NP during Waste Production and Deposition .....	21-18
21.15	Desulphurization of Tailings.....	21-18
21.16	Dealing with Uncertainty and Sufficiency of Information .....	21-18
GLOSSARY OF TERMS USED IN PREDICTION OF DRAINAGE CHEMISTRY FROM SULPHIDIC GEOLOGICAL MATERIALS .....		GLOSSARY-1
Introduction.....		GLOSSARY-2
Units of Measure - Symbols .....		GLOSSARY-4
Acronyms.....		GLOSSARY-5
Terms Pertaining to Drainage Chemistry and Weathering of Sulphidic Geological Materials .....		GLOSSARY-6

## LIST OF TABLES

Table 3.1	Examples of elevated dissolved concentrations of trace elements in neutral pH effluent from selected mine operations. ....	3-8
Table 3.2	The cumulative increase in major mines with an ongoing requirement for prediction of future drainage chemistry in British Columbia. ....	3-27
Table 4.1	Required area for dilution to prevent hypothetical drainage from small rock dumps from exceeding downstream water quality objectives. ....	4-12
Table 5.1	Major inorganic species in hypothetical pH 8, oxygenated drainage. ....	5-11
Table 5.2	Common oxidation states, oxidized forms, and reduced forms in water are the best predictors of toxicity for trace metals. ....	5-16
Table 5.3	Rest potential of selected sulphide minerals. ....	5-17
Table 5.4	Formulae for some common sulphide and sulphosalt minerals. ....	5-23
Table 5.5	Sulphide mineral contents of different tailings ....	5-24
Table 5.6	Examples of common sulphate minerals associated with sulphidic geologic materials. ....	5-27
Table 5.7	The pH range resulting from acid-neutralization by common carbonate and hydroxide minerals. ....	5-39
Table 5.8	The formula and percent by weight of the main components in pure Ca, Mg, Fe and Mn carbonate minerals ....	5-39
Table 5.9	Electron microprobe analysis of percentage of Ca, Mg, Fe, Mn, Ca+Mg and Fe+Mn CO <sub>3</sub> in calcite, dolomite, ankerite and siderite grains in Asitika Group rock from the Kemess Mine. ....	5-41
Table 5.10	Relative reaction rates for sulphide oxidation at 4°C and 20°C in laboratory tests by different mines. ....	5-55
Table 5.11	Examples of sulphidic mine drainage from mines in eastern Canada . ....	5-56
Table 6.1	A description of local geological units. ....	6-11
Table 7.1	Common project components ....	7-2
Table 7.2	Average ABA results for > and < 2 mm fractions in waste rock from a metal mine. ....	7-14
Table 7.3	An example of the different materials placed in a tailings impoundment. ....	7-38
Table 8.1	Suggested initial number of samples and test work ....	8-7
Table 8.2	Suggested initial sampling frequency based on tonnage when sampling without prior information. ....	8-8
Table 9.1	Minimum recommended descriptive statistics for static tests. ....	9-4
Table 9.2	Generically required scatterplots for Acid Base Accounting. ....	9-5
Table 9.3	A synopsis of typical test conditions for various kinetic tests. ....	9-14
Table 10.1	Examples of detection limits and costs for total solid phase elemental analysis. ....	10-15
Table 11.1	Field test for minerals by abrasion pH. ....	11-11
Table 12.1	Percent total sulphur removed by anoxic hot hydrochloric acid followed by hot hydrochloric acid / chromium chloride with and without SnCl <sub>2</sub> . ....	12-17
Table 12.2	Sulphur extracted by HCl pyrolysis at 550°C, and pyrolysis at 550°C followed by HCl. ....	12-20
Table 13.1	The acid addition and equivalent kg CaCO <sub>3</sub> / tonne of the acid for the different Sobek NP procedure fizz ratings. ....	13-13
Table 13.2	Examples of Sobek-NP discrepancies. ....	13-14
Table 15.1	Suggested incremental additions and concentrations of HCl. ....	15-7
Table 16.1	Standard sieve mesh sizes. ....	16-4
Table 17.1	An example of Rietveld analysis results for rock samples containing a number of different carbonate minerals ....	17-15

---

Table 17.2	An example of electron microprobe analysis of the chemical composition of carbonate minerals .....	17-20
Table 17.3	Electron microprobe and Rietveld analysis of XRD data can be used to interpret CO <sub>3</sub> -NP and Sobek-NP results .....	17-20
Table 18.1	Recommended equations for interpreting laboratory kinetic tests.....	18-13
Table 18.2	Final criteria for interpreting crushed/rinse pH and NPR.....	18-19
Table 19.1	A comparison between humidity cell and field test pad results can indicate the proportional retention of weathering products.....	19-17
Table 19.2	A comparison between drainage chemistry measured for a field test pad and the equilibrium limitation predicted with an empirical model at the Tulsequah Chief Project in British Columbia.....	19-17
Table 20.1	Example of an Empirical Drainage Chemistry Model including an open pit, several waste rock dumps and a tailings impoundment at a mine in British Columbia.....	20-3

## LIST OF FIGURES

Figure 2.1	A conceptual model showing management units created from geologic units with similar drainage chemistry and the resulting disposal strategies.....	2-5
Figure 3.1	Every mine and mine site is unique and the “Best Practice” is to develop a site specific prediction program. ....	3-3
Figure 3.2	Selection of prediction methods and interpretation of the results . ....	3-5
Figure 3.3	Variability in acidity of seeps from a single waste rock dump. ....	3-7
Figure 3.4a	Post-closure decline in pH and increase in sulphate of treatment plant influent resulting in a need for more treatment capacity. ....	3-11
Figure 3.4b	The onset of acidic drainage 17 years after dump monitoring started. ....	3-12
Figure 3.5	A schematic depiction of the prediction of drainage chemistry throughout the life of the project. ....	3-13
Figure 3.6	A model of trace element loadings from different project components and their relative impact on the allowable load in the receiving environment. ....	3-14
Figure 3.7	QA/QC, statistics, computer modeling and expert opinion cannot substitute for sampling and analysis of the key properties, materials, events and locations. ....	3-16
Figure 3.8	There is significant uncertainty regarding some aspects of drainage chemistry at most major precious and base metal mines and many coal mines in Canada. ....	3-17
Figure 3.9	Many key properties and processes, such as weathering of mine wastes under this soil cover at the Equity Silver Mine, are difficult to measure let alone predict. ....	3-18
Figure 4.1	Drainage chemistry prediction should be based on results from a variety of tests.....	4-4
Figure 4.2	Recommended flowchart for the prediction of drainage chemistry. ....	4-5
Figure 4.3	Evidence from several sources can provide a more reliable prediction of the drainage chemistry. ....	4-6
Figure 4.4a	Sampling and analysis of drill chips is used to characterize sulphidic materials mined at the Ekati Mine. ....	4-17
Figure 4.4b	Characterization of rock quarried next to the tailings dam at Kemess South, a considerable distance from the mine, indicated it was potentially net acidic and therefore unsuitable for dam construction. ....	4-17
Figure 4.4c	During mining, prediction also includes monitoring weathering prior to mitigation and the volume and chemistry of the associated drainage. ....	4-18
Figure 4.4d	During mining, the Huckleberry Mine continually refined its prediction of water quality for the portions of the East Zone pit and plant site that will not be flooded. ....	4-18
Figure 4.5	After a mine closes, operational monitoring of weathering and seepage may continue to track changes in properties and processes that are in flux.....	4-20
Figure 5.1	The Eh and sequence of oxidation-reduction reactions . ....	5-14
Figure 5.2.	Adsorption of various metal cations and oxyanions by ferrihydrite . ....	5-20
Figure 5.3	Melanterite precipitated along a seepage path.....	5-28
Figure 5.4	Comparison of the rate of oxidation of pyrite by ferric iron and dissolved oxygen for different ratios of area to mass. ....	5-33
Figure 5.5	The Goldich Stability Series ranking silicate minerals . ....	5-43
Figure 5.6	Relative reaction rates as a function of temperature calculated with the Arrhenius equation for the oxidation of pyrrhotite. ....	5-54
Figure 6.1	Baseline studies were part of the information used to set discharge limits for the drainage chemistry at the Huckleberry Mine. ....	6-2

Figure 6.2	A topographical map showing the water courses and landforms associated with the tailings impoundment and surface openings of the underground mine at the Snip Mine. ....	6-3
Figure 6.3	An example of a monitoring station set up to measure site climate conditions. ....	6-4
Figure 6.4	An aerial photograph is an effective way of showing the location of the major water courses at the Johnny Mountain Mine. ....	6-5
Figure 6.5	Weirs can be constructed to measure flow at major water quality monitoring locations. ....	6-6
Figure 6.6	A description and mapping is needed for all the geologic materials excavated, exposed or disturbed by mining. ....	6-14
Figure 6.7	Geological block models are used in most mines for mapping environmental geochemical information. ....	6-14
Figure 7.1	There often are a large number of different sulphidic mine components. ....	7-3
Figure 7.2	The processes to produce cycloned, desulphurized tailings sand that is used to buttress the downstream shell of the Kemess tailings dam in British Columbia. ....	7-29
Figure 7.3	Low density lime treatment sludge stored in an aerated pit lake. ....	7-36
Figure 7.4	High density lime treatment sludge stored on a gravel pad. ....	7-36
Figure 7.5	Materials that have precipitated along water courses may continue to affect their drainage chemistry long after the discharge has stopped. ....	7-38
Figure 7.6a	Conceptual model of the mine workings and waste materials showing the movement of solids between different project components. ....	7-48
Figure 7.6b	Conceptual model of drainage sources, pathways and discharges. ....	7-48
Figure 8.1	Example of required geologic cross sections showing the location of core samples. ....	8-5
Figure 8.2	The Munsell colour system. ....	8-18
Figure 8.3	Different weathering and geochemical conditions or zones of leaching can sometimes be identified by colour changes. ....	8-19
Figure 8.4	Colour may be indicative of more than one weathering condition. ....	8-19
Figure 9.1	Scatterplots of xNNP vs. crushed pH from B.C. mines. ....	9-6
Figure 9.2	Scatterplots of xNPR vs. crushed pH from B.C. mines. ....	9-7
Figure 9.3	Scatterplots of xNNP vs. total sulphur and Sobek NP from B.C. mines. ....	9-8
Figure 9.4	Scatterplots of xNPR vs. total sulphur and Sobek NP from B.C. mines. ....	9-8
Figure 9.5	Scatterplots of xNPR vs. xNNP from B.C. mines. ....	9-9
Figure 9.6	Monitoring of the rate and volume of flow are needed to calculate contaminant loadings. ....	9-16
Figure 12.1	Three step sequential extraction procedure. ....	12-21
Figure 13.1	The current drainage pH does not depend on the concentration of acid generating minerals. ....	13-2
Figure 13.2	The current drainage pH only becomes acidic when neutralizing minerals are depleted and the rate of acid neutralization becomes inadequate. ....	13-2
Figure 13.3	The relative magnitude of neutralizing and acid generating minerals is used to predict which will be exhausted first. ....	13-3
Figure 13.4	The presence of significant concentrations of Fe and Mn CO <sub>3</sub> can be detected by CO <sub>3</sub> -NP > acid titratable bulk NP. ....	13-10
Figure 13.5	The fizz test consists of adding one or two drops of 25% HCl to a 0.5 g sample and observing the degree of reaction. ....	13-15
Figure 14.1	Scatterplots of NNP vs. crushed pH. ....	14-5
Figure 14.2	Scatterplots of NPR vs. crushed pH. ....	14-6
Figure 14.3	Scatterplots of NNP vs. total sulphur and Sobek NP. ....	14-7
Figure 14.4	Scatterplots of NPR vs. total sulphur and Sobek NP. ....	14-7
Figure 14.5	Scatterplots of NPR vs. NNP. ....	14-8

Figure 14.6 Molar ratio of (Ca+Mg)/SO <sub>4</sub> representing sample specific NPRs versus time in weeks for two humidity cells. ....	14-10
Figure 14.7 NPR of < 2 mm fines in waste rock dump versus NPR of unsorted pre-blast drill cuttings....	14-12
Figure 14.8 Safety factors may be required to account for limitations in the precision and accuracy of sampling, determination of AP and effective NP, data interpretation, segregation and other aspects of material handling. ....	14-13
Figure 17.1 Visual descriptions of drill core provide valuable mineralogical information. ....	17-7
Figure 17.2 A petrographic thin section cut from particles embedded in resin and stained with sodium cobaltinitrate to identify potassium feldspar. ....	17-9
Figure 17.3 A petrographic slide showing calcite grains in a fracture and feldspar and quartz grains in the surrounding groundmass. ....	17-11
Figure 17.4 The mineral phase of grains less than 20 µm in diameter in this hornfels petrographic sample are difficult to identify.....	17-11
Figure 17.5 An XRD pattern of a sample containing quartz, calcite, muscovite, pyrite, clinocllore and rutile. ....	17-13
Figure 17.6 Fitting the calculated diffraction pattern to the observed XRD pattern for a 1:1 mixture of hematite and magnetite.....	17-14
Figure 17.7 Backscattered electron image of secondary chalcopyrite deposited on carbon core. ....	17-18
Figure 17.8 Backscattered electron image of secondary pyrite as a rim on primary magnetite. ....	17-18
Figure 17.9 Laser ablation measurements of selenium concentrations in reactive minerals .....	17-21
Figure 18.1 Humidity cell for waste rock. ....	18-4
Figure 18.2 Humidity cell for tailings.....	18-4
Figure 18.3 Photograph of humidity cells being used for waste rock.....	18-5
Figure 18.4 Pre-test sample description form for kinetic samples.....	18-8
Figure 18.5 An example of a weekly report form for humidity cell kinetic testing.....	18-9
Figure 18.6 Humidity cells that remained acidic or near neutral, showing leachate pH and rates of sulphate production and NP consumption.....	18-15
Figure 18.7 Humidity cells that remained acidic or near neutral, showing leachate pH and rates of copper and zinc leaching. ....	18-16
Figure 18.8 Humidity cells that became acidic, showing leachate pH and rates of sulphate production and NP consumption. ....	18-17
Figure 18.9 Humidity cells that became acidic, showing leachate pH and rates of copper and zinc leaching. ....	18-18
Figure 19.1 The relationship between sulphidic geologic materials, weathering over time and future drainage chemistry. ....	19-1
Figure 19.2a and 19.2b. Schematic diagrams of subaerial drip leach and subaqueous leach columns...	19-4
Figure 19.3a and 19.3b. The chemistry of the column discharge may not indicate internal changes to weathering conditions.....	19-6
Figure 19.4 An example of a column design . ....	19-7
Figure 19.5 Field test pads built on a plastic liner . ....	19-9
Figure 19.6 Field test pads built in a lined wooden box. ....	19-10
Figure 19.7 Diagram of Minewall station assembly. ....	19-13
Figure 19.8 On-site monitoring can provide very useful prediction information. ....	19-15
Figure 20.1 Empirical drainage chemistry correlations with pH. ....	20-4

## 1.0 INTRODUCTION

### *Some Important Points in this Chapter*

*Drainage waters from sulphidic geologic materials can contain elevated concentrations of metals and other elements at any pH. This may lead to costly environmental management and remediation. Successful, cost-effective, proactive mitigation measures depend on an accurate prediction of future drainage chemistry. The prediction of drainage chemistry from sulphidic geologic materials is therefore important in ensuring that the extraction of Canada's mineral resources occurs in a sound fiscal manner and minimizes impacts to adjacent land and watercourses.*

*Guidance is provided on the strengths and potential limitations of different procedures, analyses, tests and criteria used to predict future drainage chemistry. This Manual recommends site specific prediction of drainage chemistry. Users of the Manual should consider local site conditions, such as the weathering environment, the stage of project development, geologic materials, mine components, environmental goals and project needs when deciding which of the procedures in this Manual to use and how to interpret the results. The document is not intended to limit the properly supported approaches or substitute for individuals with the appropriate technical training and experience.*

### 1.1 Rationale

Productive use of Canada's mineral resources can only be sustained through environmentally sound and economically viable mining practices. Environmental issues are therefore very important to the mining sector and the regions of Canada in which mines operate. The most costly and technically challenging environmental issue facing the mining industry

*Productive use of Canada's mineral resources can only be sustained through environmentally sound, economically viable mining practices.*

is the prevention of environmental impacts to land and water from the drainage from sulphidic geologic materials<sup>1</sup>.

Drainage from sulphidic geologic materials is a major concern for the mining industry because:

- most base metal (e.g. Cu, Mo, Ni, Pb and Zn) and precious metal (Ag and Au) mines, and many coal, uranium and diamond mines excavate large amounts of sulphidic rock; and
- environmental impacts, and prevention or mitigation costs, associated with mining sulphidic rock can be large.

<sup>1</sup> Sulphidic geologic materials are defined as geologic materials containing sulphide minerals, their weathering products and other reduced sulphur species. Drainage chemistry depends on the reactivity of the geologic materials as a whole not just the sulphidic materials.

Throughout the world, drainage from past mining of sulphidic geologic materials has caused extensive impacts to aquatic and terrestrial resources and multimillion dollar post-mining cleanup costs for industry and government. In 1995, the liability associated with the drainage from Canadian tailings and waste rock was estimated to be between \$2 billion and \$5 billion (Geocon and SNC Lavalin Environment, 1995).

A past approach in dealing with drainage chemistry when mining sulphidic geologic materials was a reactive, results-based approach in which remedial actions were only taken after problems occurred. The outcomes of this failure based approach were extensive environmental impacts to aquatic and terrestrial resources and multimillion dollar post-mining cleanup and remediation costs throughout the world. In some instances, the mining companies disappeared or went bankrupt leaving the public to deal with the environmental impacts and pay the prohibitive remediation costs. Recognizing that a results-based approach is prohibitively expensive and environmentally unacceptable, governments and industry now require proactive measures to prevent impacts from the drainage from sulphidic geologic materials.

Successful, cost-effective, proactive design and operation of mitigation measures for sulphidic geologic materials depend on an accurate prediction of future drainage chemistry and contaminant loadings<sup>2</sup>. Prediction is critical in the selection, design and estimated long and short term costs for mitigation facilities. The prediction of drainage chemistry from sulphidic geologic materials is therefore a major part of sound fiscal management and important in ensuring that the extraction of Canada's mineral resources occurs in a manner that minimizes impacts to adjacent land and watercourses.

## 1.2 The Source of Poor Quality Drainage Chemistry from Sulphidic Rock

Problematic drainage chemistry from sulphidic geologic materials results primarily from exposure of sulphidic geologic materials to oxygen and water. Exposure to oxygen and water results in oxidation and other weathering processes, changing relatively insoluble chemical species in sulphide minerals into more easily dissolved free ionic species or secondary minerals, such as sulphates, carbonates and hydroxides. Water can dissolve and transport these more soluble chemical species (e.g. Cu and Zn) in quantities that may exceed water quality objectives.

*Problematic drainage chemistry from sulphidic geologic materials results primarily from their exposure to oxygen and water.*

In addition to increasing the solubility of potentially harmful elements, the oxidation of some sulphide minerals produces acid. If this acid is not neutralized, it can lower the drainage pH, which can increase the:

- rate of sulphide oxidation;
- solubility of many products of sulphide oxidation; and
- rate of weathering of other minerals.

<sup>2</sup> Loading is the concentration multiplied by flow, providing a mass per unit of time flowing from a mine or mine component.



Although acidic drainage resulting from sulphide oxidation has received much attention, it is not just acidic drainage that is an environmental concern. Concentrations of metals (e.g. Zn), metalloids (e.g. As) and non-metals (e.g. Se) from sulphidic rock may also give rise to harmful levels in drainage with a near-neutral and alkaline pH from sulphidic geologic materials.

Non-sulphide minerals, such as the products of hydrothermal alteration, may contribute to the harmful concentrations found in the drainage from exposed sulphidic rock. For example, sulphate and manganese may leach from hydrothermally produced gypsum and siderite, respectively.

The term “potential” is used when referring to future drainage chemistry. This is because there is some uncertainty or because mitigation measures can be taken that can change the outcome if unacceptable environmental impacts are predicted.

### 1.3 Objectives of this Manual

The objective of this Manual is to provide guidance on how to characterize existing drainage chemistry and to predict future drainage chemistry with sufficient accuracy to prevent significant environmental impacts. Like a toolbox, the Manual discusses procedures to follow and factors to consider in planning programs, collecting samples, selecting test materials, conducting static and kinetic tests, presenting data and interpreting the results. The procedures and factors are derived from the best practices and experiences of practitioners in mine site drainage chemistry prediction. The Manual discusses the information required to address different prediction needs and key properties and processes of sulphidic geologic materials and mine components. Guidance is also provided on the strengths and potential limitations of different procedures, analyses, tests and criteria used to predict future drainage chemistry.

*The objective of this Manual is to be a toolbox of procedures and factors to consider in program planning, sampling, test work design and data interpretation.*

chemistry and to predict future drainage chemistry with sufficient accuracy to prevent significant environmental impacts. Like a toolbox, the Manual discusses procedures to follow and factors to consider in planning programs, collecting samples, selecting test

Prediction of the drainage chemistry from sulphidic geologic materials is a complicated multi-disciplinary subject, involving a large number of methods, properties and processes. The length and level of detail in this document reflects the comprehensive, in-depth level of understanding needed to design a prediction program, conduct test work and interpret or review the results. A table of contents, flowcharts and lists of tables and figures are provided to assist users in finding information on selected aspects of prediction.

This Manual recommends site specific prediction of drainage chemistry rather than prescriptive, sometimes inappropriate, universal rules. Users of the Manual should consider local site conditions, such as the weathering environment, the stage of project development, geologic materials, mine components, environmental goals and project needs, when deciding which of the procedures and tests in this Manual to use and how to interpret the results.

*Users of this Manual should consider site specific conditions when deciding which procedures and tests to use and how to interpret the results.*

sometimes inappropriate, universal rules. Users of the Manual should consider local site conditions, such as the weathering environment, the stage of project development,

All stages of project life from planning to post-closure are discussed here. The Manual was written to assist both the technical specialist designing a prediction program or conducting prediction work and the general practitioner setting terms of reference or reviewing prediction results. The Manual is also intended to serve as a reference document for members of the public, educators and students studying or reviewing drainage chemistry prediction work.

By noting inherent assumptions, limitations and common errors and omissions associated with different prediction procedures, this document will reduce the repetition of past mistakes. It also discusses what is and is not known, where improvements are required and allows for constructive criticism of the advocated practices. Better prediction through adherence to the guidance and methods in this Manual can lead to more accurate prediction and better waste handling strategies.

This document is only a guide and is not intended to limit properly supported options and

*This Manual is not intended to serve as a substitute for individuals with a comprehensive knowledge of the site and the appropriate technical training and experience.*

approaches or substitute for individuals with a comprehensive knowledge of the site and the appropriate technical training and experience. Nor is it intended to replace site specific regulatory requirements. Practitioners should also

consider regulatory, community and corporate requirements. They should discuss the details of their prediction programs with the project planners, regulatory agencies and other interested parties, such as local governments and residents, to ensure that all the necessary information is collected and is available when needed for decision making. It is important to note that much of the information presented here was derived from experience gained in Canada, although many of the concepts are universal. In a similar vein, although the focus of this Manual is the prediction of the drainage chemistry from sulphidic materials, many of the methods will be applicable to the prediction of drainage chemistry from other geologic materials, such as limestone and potash tailings.

#### 1.4 Layout of this Manual

This Prediction Manual is divided into topics, like an encyclopedia or compendium of

*This Manual is divided into topics, like an encyclopedia or compendium of information, grouped by general topics into many chapters.*

information, grouped by general topics into many chapters. The Table of Contents, lists of tables and figures, summary of chapters and flowchart at the beginning of this

document highlight its layout and allow navigation through the chapters.

#### 1.5 Guideline Development

This Manual was developed from the British Columbia Ministry of Energy, Mines and Petroleum Resources<sup>3</sup> report *Draft Manual of Guidelines and Recommended Methods for the Prediction of Metal Leaching and Acid Rock Drainage at Minesites in British Columbia (Price, 1997)* and the overall *Guidelines for Metal Leaching and Acid Rock Drainage at Minesites in British Columbia (Price and Errington, 1998)*. Like its precursors, the Manual is derived from

the best practices of the mining industry, government, academia and community groups in conducting mine site drainage chemistry prediction. In addition to lessons learnt from the use of previous guidance documents, this document has benefited greatly from information provided by a large number of contributors, reviewers and other documents.

The Manual is by nature a working document as much remains to be discovered about mine site weathering and drainage chemistry. Future improvements in prediction methods as a result of the worldwide research, site monitoring, improvements in theoretical understanding and additional experiences of practitioners will undoubtedly require periodic reviews and changes to this Manual.

## 1.6 References

Geocon – SNC Lavalin Environment. 1995. Economic Evaluation of Acid Mine Drainage Technologies. MEND 5.8.1. Economic Evaluation of Acid Mine Drainage Technologies.

Price, W.A. 1997. Draft Guidelines and Recommended Methods for the Prediction of Metal Leaching and Acid Rock Drainage at Minesites in British Columbia, Energy and Mines Division, British Columbia Ministry of Employment and Investment<sup>3</sup>.

Price, W.A. and J. Errington. 1998. Guidelines for Metal Leaching and Acid Rock Drainage at Minesites in British Columbia, Energy and Minerals Division, British Columbia Ministry of Employment and Investment.

---

<sup>3</sup> The current British Columbia (BC) Ministry of Energy, Mines and Petroleum Resources has gone under several names, including the BC Ministry of Employment and Investment and the BC Ministry of Energy and Mines



## 2.0 OVERALL OBJECTIVES OF PREDICTION

### *Some Important Points in this Chapter*

*The objective in predicting drainage chemistry is to determine the type, magnitude, location and timing of measures required to prevent significant environmental impacts. These objectives are achieved by: measuring the present drainage chemistry; predicting the potential future drainage chemistry; determining the influential properties and processes; and predicting the timing of significant changes in the drainage chemistry and influential properties and processes. Predictions should be made for all excavated, exposed and otherwise disturbed sulphidic geologic materials.*

*Our understanding of the properties and processes determining drainage chemistry is far from complete. However, the available prediction tools combined with a comprehensive, well-informed approach and cautious interpretation of the results should allow mines with sulphidic geologic materials to meet receiving environment objectives and minimize the liability and risk. The predicted drainage chemistry will often be a range in contaminant concentrations because of the range of properties within each geologic and waste management unit and the limited accuracy and precision of the prediction methods. Uncertainty regarding drainage chemistry should be reduced to the level at which plans that will meet the environmental objectives can be designed and implemented.*

The overall objectives for measuring and predicting drainage chemistry are to determine the type, magnitude, location and timing of potential significant environmental impacts<sup>4</sup> and the measures required to prevent them. These objectives are achieved by:

- measuring the present drainage chemistry;
- predicting the potential<sup>5</sup> future drainage chemistry;
- determining the influential properties and processes; and
- predicting the timing of significant changes in the drainage chemistry and influential properties and processes.

Ideally, predictions of the above should be made for all excavated, exposed and otherwise disturbed<sup>6</sup> sulphidic geologic materials at every stage of a project.

---

<sup>4</sup> Drainage from sulphidic geologic materials is considered to have a significant impact if it exceeds discharge limits or negatively impacts a valued resource or environmental component downstream of, down wind of, or using the site.

<sup>5</sup> The term potential is used because predictions may be incorrect or measures could be taken to prevent its occurrence if unacceptable drainage chemistry is predicted.

<sup>6</sup> Materials impacted indirectly by changes, such as lowering the water table and altering flow paths, that could result in changes to weathering and leaching. A simple example is when a road blocks overland and near surface flow causing seasonal flooding of materials on the upstream side.

Prediction information will be used to ensure the mine plan, mitigation and additional prediction actions enable the project to meet the environmental objectives. The environmental objectives or goal posts include objectives for the discharge, receiving environment and reclaimed areas of the project.

Prediction information is used to determine the requirements for the following potential mining, mitigation and additional prediction actions:

- mining and ore processing;
  - excavation,
  - processing,
  - waste handling and
  - waste disposal.
- mitigation;
  - initial mitigation measures,
  - adaptive management,
  - contingency plans and
  - provision of financial resources.
- additional prediction;
  - monitoring,
  - operational material characterization and
  - supplemental prediction studies.

The environmental objectives, potential mining and mitigation options and additional prediction actions must be kept in mind when designing each phase of a prediction program and interpreting the results.

The predicted drainage chemistry will often be a range in contaminant concentrations because of

*The predicted drainage chemistry will often be a range in contaminant concentrations because of the range of properties within each geologic and waste management unit and the limited accuracy and precision of the prediction methods.*

the range of properties within each geologic and waste management unit and the limited accuracy and precision of the prediction methods. The objective is to reduce the uncertainty regarding

drainage chemistry to a level at which plans that will meet the environmental objectives can be designed and implemented. Decisions regarding mitigation often require a prediction of both the probable variation and the worst case drainage chemistry.

Some prediction questions regarding mining and mitigation that generally need to be answered are as follows:

- How large a reduction in contaminant concentrations and loadings is required to meet discharge limits and receiving environment objectives?
- What changes in environmental conditions are required to prevent or sufficiently reduce the rate of deleterious weathering?
- When must mitigation occur and what are the consequences of delayed mitigation?

- What combinations of waste type/exposure type/geologic material will produce similar drainage chemistry and require similar mitigation and should, if possible, be placed in the same management unit (Figure 2.1)?
- What is the mass, volume and the required storage locations and space for each geologic unit, management unit and disposal strategy?
- What waste materials can be safely used for what types of construction?
- What effect will differences in the scheduled excavation of different geologic units have on the required timing of the construction of disposal facilities and implementation of mitigation measures?

The required reduction in weathering rates and contaminant concentrations will depend on the chemistry and loadings and the discharge limits and objectives for the receiving environment and the site.

*The required reduction in weathering rates and contaminant concentrations will depend on the chemistry and loadings and the discharge limits and objectives for the receiving environment and the site.*

For example, if lime treatment is an option, the required capacity for lime addition and slaking will depend on

the maximum acidity and flow rate of the drainage that will have to be treated and the treatment pH required to adequately reduce the concentration of the contaminants of concern. Decisions regarding mitigation often require a prediction of both the probable and the worst case drainage chemistry.

An important part of most mitigation strategies is the use of the prediction data in identifying geologic units and creating waste management units from geologic materials with similar geochemical properties (Figure 2.1). Also, geologic units containing material whose predicted drainage chemistry is significantly different and could be managed differently (e.g. different handling procedures and mitigation measures) may be sub-divided into different management units. Conversely, it may be possible to reduce the number of management units by combining geologic materials whose predicted drainage chemistry is not significantly different and can be managed similarly (e.g. similar handling and mitigation).

The mitigation methods selected to reduce solute concentrations will depend in part on which minerals and weathering reactions are present or predicted. For example, flooding may not be a viable option without some form of treatment, if previous exposure of the material to oxidizing conditions has produced high concentrations of potentially soluble secondary minerals.

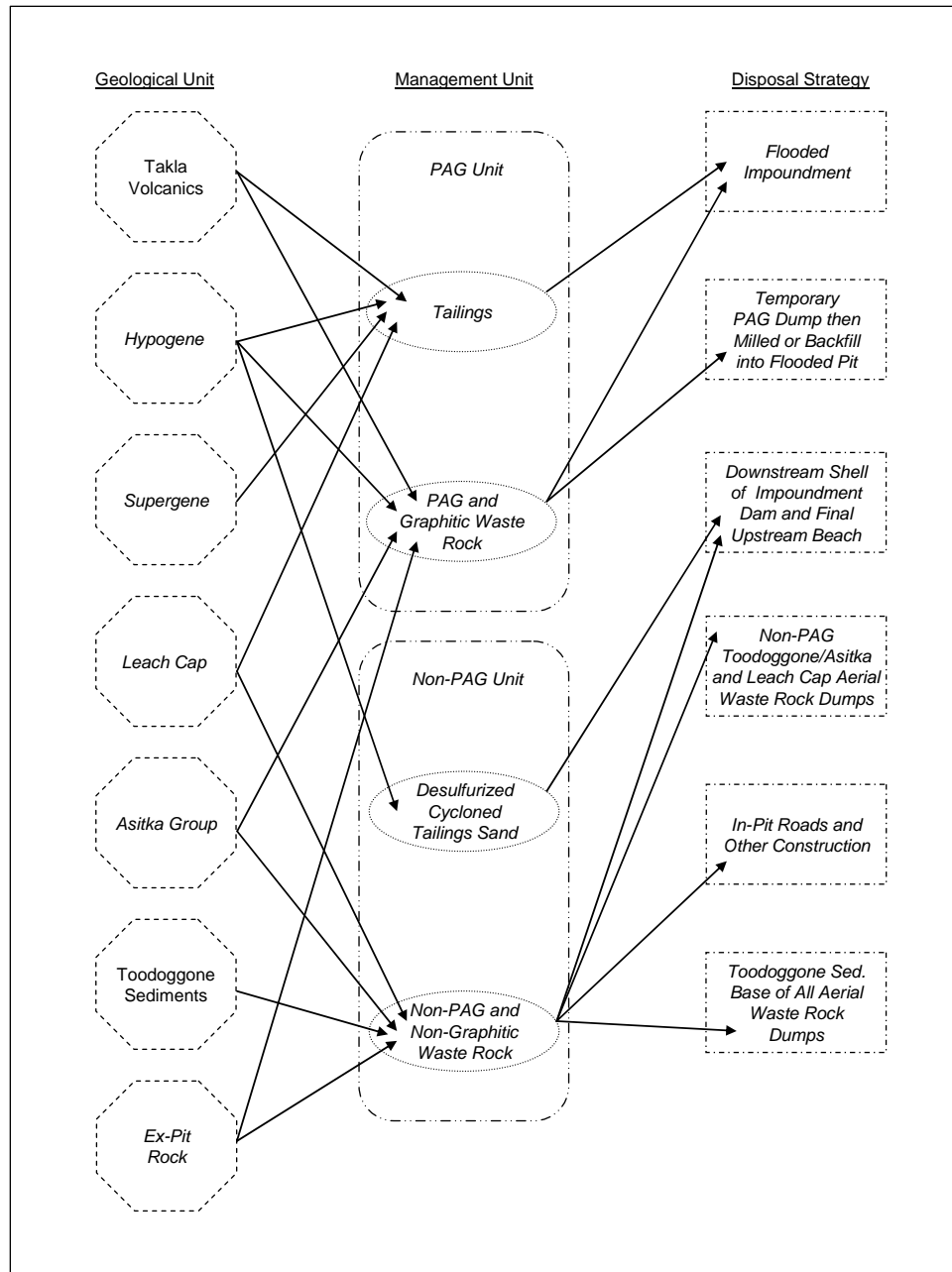
The answer to the question of when mitigation should occur (e.g. when should flooding reach the waste surface) will depend on the rate of weathering prior to mitigation, the impact of mitigation on the discharge of previous weathering products and the timing of key changes in weathering and drainage geochemistry. The required disposal space will depend on the mass or volume of each management unit and mine component. For example, if underwater disposal is the proposed mitigation measure for preventing acidic drainage, how large a volume of tailings and waste rock is predicted to be potentially net acid generating?

The exact nature of the prediction questions listed above, the materials and methods required in answering them, and when the information will be needed will depend on various factors including:

- composition of the excavated, exposed and otherwise disturbed sulphidic geologic materials;
- environmental conditions of the general site and each mine component;
- the type and stage of the project;
- mitigation options; and
- timing of project management actions and regulatory decisions (see Chapter 3).

Mitigation needs will become more clearly defined as prediction testing proceeds. Conversely, changes in material management and mitigation options will affect what prediction questions need to be answered, what data is required, the significance of predicted differences in drainage chemistry, and may necessitate changes or additions to prediction test work. Although our understanding of drainage chemistry is far from complete, the available prediction methods, combined with a cautious interpretation of the results, should allow mines to meet receiving environment objectives and minimize liability and risk.





**Figure 2.1 A conceptual model showing management units created from geologic units with similar drainage chemistry and the resulting disposal strategies (information provided by Kemess Mine).**



### 3.0 GENERAL PRINCIPLES AND BEST PRACTICES

#### *Some Important Points in this Chapter*

*The “best practice” for drainage chemistry prediction is to take a site specific and proactive approach. Drainage chemistry should be predicted for all geologic materials in the forms that will be excavated, exposed or otherwise disturbed (the resulting project components). Prediction should consider the spatial variability and temporal changes in the contributing properties and processes and use an iterative, phased and scientific approach. Due to the large number of factors involved, proper planning is an essential component of successful prediction. Prediction should occur throughout the life of the project. The objective at each stage is to demonstrate that the project has the necessary understanding, capability, resources and intent to protect the environment. Challenges in prediction include dealing with uncertainty and changes in mine plans. It is important to identify the materials and methods and intended uses for prediction work, use clearly defined terminology and consider the cost-effectiveness prior to initiating each phase of test work. Prediction requires qualified personnel and adequate resources. Maintaining prediction information in an accessible form that facilitates regular review and tracking of changes is also extremely important. Practitioners should be aware of past errors in prediction, act safely and recognize that a proper understanding can only be achieved by reviewing the details regarding site conditions, sampling, sample preparation, analyses, test procedures and the interpretation of data.*

This Section outlines the general principles and best practices for successful and cost-effective prediction of drainage chemistry.

#### 3.1 Take a Site Specific Approach

Each site or project has different components and a unique combination of geologic and environmental conditions (Figure 3.1). As a result, a rigid set of rules for drainage chemistry prediction would be unnecessarily restrictive at many sites, and insufficient to handle all the anomalous conditions that could result in significant environmental impacts. Therefore, the “best practice” for drainage chemistry prediction is to take a site specific approach in the selection of analyses and test work and the interpretation of the results.

*The “best practice” for drainage chemistry prediction is to take a site specific approach in the selection of analyses and test work and the interpretation of the results.*

Often, there is more than one environmentally acceptable way to achieve environmental protection goals. In these cases, site or project specific factors may justify deviation from the procedures recommended in this Manual. The project components and geologic and environmental conditions, coupled with the strengths and limitations of the tests, will determine the best combination of analyses and tests to use in predicting drainage chemistry. Generally,

recommended procedures may be unnecessary in some situations. Similarly, there will be instances where there are additional information requirements or factors to consider. In most situations, concurrent use of several similar prediction tests or analytical procedures will result in predictions that are more reliable.

Site specific prediction requires a good understanding of the geologic materials and the project components, as well as a well-informed assessment of the prediction results and potential impacts. Developing the required understanding of site specific conditions to predict drainage chemistry may not be an easy task.

*Developing the required understanding of site specific conditions to predict drainage chemistry may not be an easy task.*

The detailed understanding of the geologic materials, project components and weathering conditions needed to identify site specific opportunities and the constraints may cost hundreds of thousands of dollars and require several years to accomplish. Although this expenditure may seem onerous, the costs are generally minimal compared to environmental impacts or mitigation costs that may last indefinitely because of inadequate information.

### 3.2 Predict the Drainage Chemistry of All Geologic Materials and Project Components

The assessment of potential environmental impacts requires prediction of the drainage chemistry for all geologic materials (e.g. bedrock and non-lithified surficial materials like soil) that will be or have been excavated, exposed, processed, deposited or otherwise disturbed and the resulting project components. Examples of the latter form of disturbance include changes to the height of the water table or the rate of groundwater movement, which may change geochemical or hydrological conditions and increase contaminant concentrations or contaminant loading.

*The assessment of potential environmental impacts requires prediction of the drainage chemistry for all geologic materials that will be or have been excavated, exposed, processed, deposited or otherwise disturbed.*

Only a small portion of the geologic material or project component may be responsible for most of the contaminant discharge causing significant environmental impacts. For example, high metal concentrations in neutral pH drainage may result from localized, relatively small zones of acidic weathering. Consequently, it is important to predict the range and spatial variability in material composition and their effects on drainage chemistry. Any significant gaps in sampling and testing of the geologic and geochemical variability should be identified and reported.



**Figure 3.1** Every mine and mine site is unique and the “Best Practice” is to develop a site specific prediction program based on site conditions, required environmental protection needs of the mine and properties and processes of the mitigation measures (photo of Johnny Mountain Mine in northwest British Columbia).

A wide variety of materials, in addition to sulphide minerals, may contribute to drainage chemistry. For example, non-sulphide minerals produced by hydrothermal alteration are a potential source of many chemical species (e.g. sulphate from gypsum or manganese from siderite). Other materials that may make significant contributions to drainage chemistry include:

- sediment transported downstream or downwind by water or wind erosion or mass failure events; and
- precipitates formed along watercourses and flow paths by evaporation or mixing different drainages.

Geologic material used for construction can be a potential problem even if they are a considerable distance from the mine. For example, characterization of rock quarried several kilometers from the pit at Kemess South indicated that the rock would become net acidic and was therefore unsuitable for construction of the unflooded, downstream buttress of the tailings dam (Figure 4.4b). Also, country rock used for construction was reportedly the main source of acidic drainage at the Greens Creek Mine (Condon, 1999; Kennecott Greens Creek Mining Company, 2003).

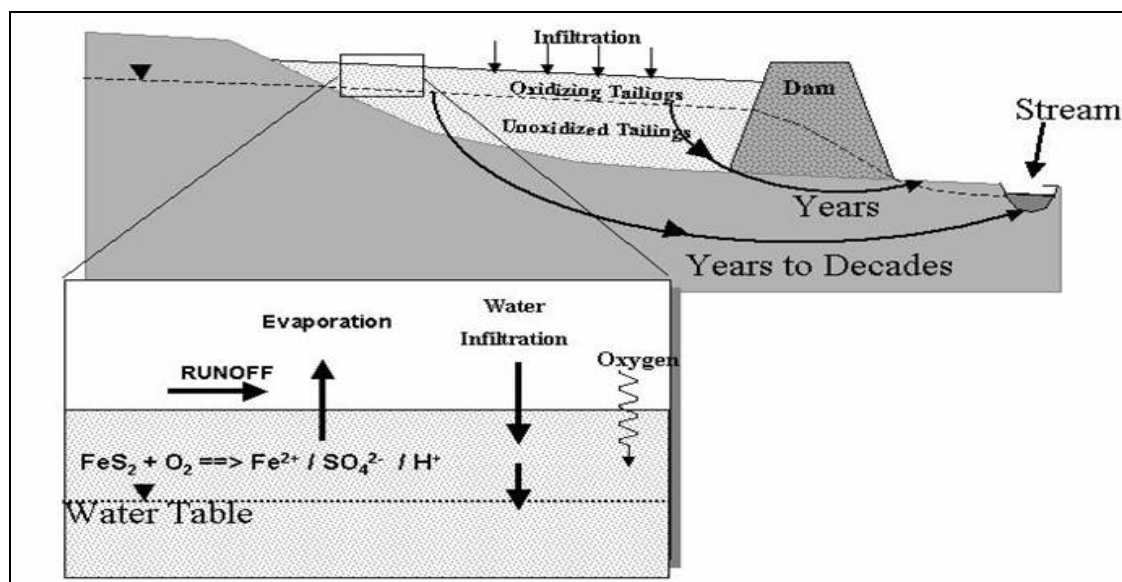
Non-geologic materials may also contribute to the chemistry of drainage from project components. Examples include process chemicals, which may be a source of alkalinity and trace metals from tailings impoundments and galvanized steel, which is a potential source of zinc from underground workings.

### **3.3 Consider All Potentially Influential Properties and Processes**

Prediction of the drainage chemistry from sulphidic materials requires understanding of a large number of properties and processes (Figure 3.2). These properties and processes include:

- project type, history, present stage and proposed future development (Chapter 4);
- mineralogy and weathering conditions (Chapter 5);
- climate, geology and other site conditions (Chapter 6);
- excavation, processing and construction methods and the magnitude and physical, drainage, atmospheric and geochemical conditions of the project components (Chapter 7);
- selection, storage and preparation of samples (Chapter 8);
- analyses and test procedures;
- environmental protection and reclamation objectives; and
- management and mitigation measures or options.

All these potentially influential properties and processes must be considered when designing a drainage chemistry prediction program and interpreting the results. While some generic analyses and tests are usually required (Chapter 4), the sampling methods, sample pretreatment, laboratory analyses, kinetic tests, data analyses and the sequence of work will also depend on the site and project specific properties and processes of the project.



**Figure 3.2 Selection of prediction methods and interpretation of the results need to be based on an understanding of site conditions and the variability in properties and processes potentially contributing to drainage chemistry.**

It is easy to be overwhelmed by the many influential processes, interactions and changing properties. Due to the large number of factors involved, proper planning is an essential component of successful prediction. A well-informed and well crafted prediction program, including proper consideration of challenges involved, should ensure environmentally safe practices that will be both time and cost efficient.

*It is easy to be overwhelmed by the many influential processes, interactions and changing properties. A well-informed and well crafted prediction program, including proper consideration of challenges involved, should ensure environmentally safe practices that will be both time and cost efficient.*

Owing to the significant analytical costs, potential for delays, site specific requirements and uncertainty regarding proper test protocols, each phase of the prediction program should be discussed with the responsible regulatory agencies prior to its implementation and as test work progresses.

### 3.4 Be Proactive

Proactive prediction of drainage chemistry is needed to ensure mitigation measures prevent significant impacts, are cost-effective and that the required financial resources are available. Proactive prediction is needed to ensure remedial measures are factored into mine plans and feasibility studies. Remediation costs, such as moving wastes to a flooded location or drainage treatment, may be orders of magnitude higher if drainage chemistry needs are not adequately considered in the initial mine plan and at mine closure.

Prediction tasks of sampling, analysis, test work and the interpretation of prediction results should be completed in time to meet the proactive, decision making needs of a project. Pre-mine material characterization and the prediction of unacceptable drainage chemistry is needed prior to mine development so the results can guide plans for excavation, materials handling, waste disposal and mitigation. Predictions of post-closure drainage chemistry need to be finished prior to mine closure, so operating mine equipment and personnel can be used to implement any changes to the mitigation plan. Since an iterative, phased approach is the most cost-effective means of information collection and there are often follow-up questions, prediction tasks should be started as soon as possible.

*Be proactive using prediction, rather than reactive after a problem arises. This can save time and money and provide more options for a solution. If a solution cannot be selected, at least the issue can be marked for further study and later resolution.*

Even if issues cannot be resolved, their identification early in the mine life permits a mine to use its operating facilities, equipment and personnel to conduct long term field studies, evaluate different solutions and act on the results prior to mine closure. Removal of personnel and equipment and reduced access after mine closure increase the costs of field studies and subsequent remediation. This is especially important for underground mines where access may be impossible soon after mining ceases.

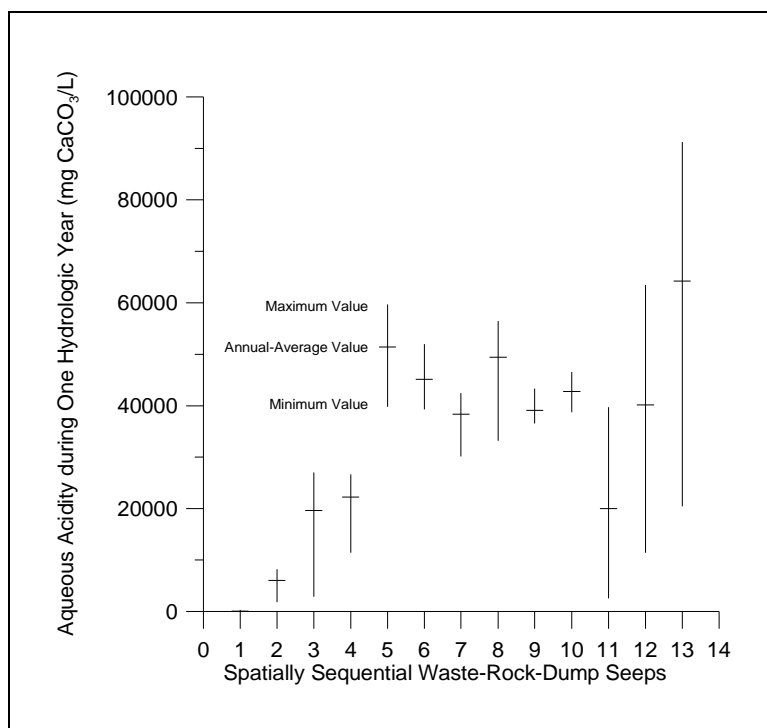
### **3.5 Demonstrate Necessary Understanding, Capability, Resources and Intent**

An objective of prediction at each stage of a project is to demonstrate that the project has the necessary facilities, plans, understanding, site capacity, resources and intent to sustain the mitigation needed for environmental protection. This includes identification of and development of contingency plans to deal with significant gaps in the prediction of drainage chemistry. Demonstration that a project has the necessary understanding, capability, resources and intent to deal with the drainage chemistry may have implications in setting the financial security needed to sustain environmental protection.

### **3.6 Consider the Range and Variability in Properties and Processes**

Characterization of the range and variability in geochemical, drainage, atmospheric and physical properties and processes is an important part of drainage chemistry prediction. Spatially and temporally, different wastes and project components often have widely varying geochemical and physical properties and processes. As a result, they may exhibit wide ranges of weathering conditions and produce differing drainage chemistry (e.g. Figure 3.3).





**Figure 3.3 Variability in acidity of seeps from a single waste rock dump (Morin and Hutt, 2004).**

Most of the contaminants may be produced by only a small portion of total material, drainage or during certain times of the year. For example, 5% of the waste rock may be responsible for 99% of the copper or acidity loading, or environmental impacts may only occur during the seasons with the highest or lowest flow. Therefore, selection of prediction methods and interpretation of the results need to be based on a good understanding of the range and variability in properties and processes contributing to drainage chemistry.

*Most of the contaminants may be produced by only a small portion of total material, drainage or during certain times of the year.*

Some of the actions that should be used to ensure a proper assessment of the range and variability in composition and to identify potentially problematic material or locations within geologic units and project components include the following.

- Review the individual sample results before calculating descriptive statistics.
- Map the spatial variability in key geochemical, drainage, atmospheric and physical properties and processes.
- Avoid compositing samples or averaging, interpolating or extrapolating sample results if this may mask potentially problematic sample properties or result in a misclassification of significant amounts of potentially problematic material.

The prediction of drainage chemistry may need to identify outliers and understand the variability at a smaller scale than other geochemical activities on mine sites such as the measurement of ore grades and metal recovery during processing.

### 3.7 Consider All Elements, Minerals and Drainage pH Ranges

The problems associated with the drainage from sulphidic geologic materials are not just metals and acidic drainage. Metalloids and non-metals and elements in non-sulphide minerals and drainage with a near-neutral and alkaline pH may also exceed environmental guidelines (Table 3.1). If there is very little dilution and a sensitive component of the environment, even metals that are relatively insoluble in neutral pH drainage, such as aluminum and copper, can be a concern. Redox (aerated-anaerobic) conditions are important for predictions of elements like iron and arsenic.

*The problems associated with the drainage from sulphidic geologic materials are not just metals and acidic drainage.*

The potential drainage chemistry and elemental loadings from sulphide bearing geologic materials should be evaluated for all elements of concern, minerals, drainage pH, and site specific environmental conditions. Prediction of whether the drainage will have an acidic pH may be important, but is not the only information that is required.

**Table 3.1 Examples of elevated dissolved concentrations of trace elements in neutral pH effluent from selected mine operations (adapted from Stantec, 2004).**

Element	pH	Dissolved Concentration (mg/L)	Most Restrictive Water Quality Guideline (mg/L)
Antimony	8.5	0.9	0.006
Arsenic	8.0	0.3	0.005
Cadmium	6.5	0.07	0.000017
Cobalt	8.0	1.1	0.0009
Copper	7.3	0.06	0.002
Manganese	8.1	33.5	0.05
Molybdenum	8.3	29	0.073
Nickel	8.1	3.8	0.025
Selenium	7.5	1.6	0.001
Zinc	8.1	14.4	0.03

### 3.8 Consider Temporal Changes in Properties and Processes Controlling Drainage Chemistry

When predicting future drainage chemistry, it is important to consider temporal changes in the properties and processes controlling drainage chemistry. Mining activities, such as bedrock exposure, overburden movement, dam construction and waste disposal, alter many of the properties and processes controlling drainage chemistry. Future changes may occur gradually,

periodically or after some threshold is crossed. Periodic changes may result from events such as fire or the variation in climate conditions. Drainage chemistry may remain relatively stable until some geochemical or drainage threshold is crossed. A lack of environmental impacts to date provides no assurance that there will be no impacts in the future unless there is supporting data to rule out adverse future changes in the properties and processes controlling drainage chemistry.

Properties and processes that contribute to drainage chemistry and may be in flux include:

- physical and chemical weathering;
- drainage properties and processes such as dewatering and flooding;
- erosion and sedimentation;
- project related properties and processes associated with exploration, construction, excavation, processing, waste management and closure activities and the resulting changes to weathering and drainage conditions;
- off-site anthropogenic and natural activities that alter land and drainage conditions, such as logging, forest fires, forest succession, and industrial or urban development; and
- properties and processes that change due to individual climate events, seasonal and annual climate differences and longer term climate change.

Most important from the perspective of drainage chemistry are the changes to properties and processes controlling weathering and mineral stability when the bedrock is converted into waste rock and tailings and when mine walls are exposed to air and water. Exposure of fresh rock surfaces to air and water can result in a large number of different weathering reactions. This includes the oxidation and leaching of sulphide minerals, which are the primary reactions responsible for environmental impacts from the drainage of sulphidic geologic materials. Organic matter additions from aquatic plant growth following flooding of oxidized rock and overburden may result in the reductive dissolution of secondary minerals created under aerated conditions.

Weathering effects may change geochemical and drainage conditions through mineral depletion and precipitation, mineral exposure, reduction in rock strength and particle size reduction. Depletion of acid neutralizing minerals or sulphide minerals galvanically suppressing pyrite oxidation may decrease the pH. Mineral exposure and particle size reduction may delay the depletion of weathering minerals. Particle size reduction, hardpan creation and large scale surface subsidence may change drainage rates and conditions. Particle disintegration and settling in waste rock dumps may change flow paths, diverting drainage into previously relatively unleached areas of secondary minerals accumulation.

Other major change to the properties and processes controlling drainage chemistry are changes in drainage conditions, such as the locations and rates of drainage inputs, rates of leaching and the height of the water table. Excavation of mine workings, waste disposal and other surface disturbances may create new flow paths for runoff and groundwater, increasing drainage inputs in some areas and reducing them in others. Dewatering of pits and underground workings may lower the regional water table thereby reducing drainage inputs and increasing air entry into other mine components. Post-mining hydrogeology may be very different from what it was prior to mining and difficult to predict.

Flooding that occurs after mining is finished may flush previously formed oxidation products and stop further sulphide oxidation. Overflow from mine working may cause a rapid increase in contaminant discharge (Price, 2005). If mine workings flood after mining is finished, a rebound in the regional water table may also increase the leaching of and discharge from downstream mine components, changing the weathering environment, reducing geotechnical stability and flushing out accumulated secondary minerals. Underground workings and pits may become hydraulic sinks for previously diffused groundwater, concentrating flow and creating discrete discharge locations.

*Flooding that occurs after mining is finished may flush previously formed oxidation products and stop further sulphide oxidation.*

Impoundments and tailings may raise the height of the water table resulting in the reductive dissolution of secondary minerals in the underlying, previously aerated overburden. In a flooded impoundment, post-flooding changes in geochemistry, plant communities and drainage inputs may impact discharge quality and the health of species colonizing a water cover. Post-closure increases in arsenic concentrations and loading from flooded mine wastes in Ontario have been attributed to organic inputs and eutrophication of the overlying water cover lowering the redox of the underlying oxidized mine wastes (Martin et al., 2001). Biotic layers on the top of flooded mine wastes may reduce the migration of metals into the water cover (Vigneault et al., 2008).

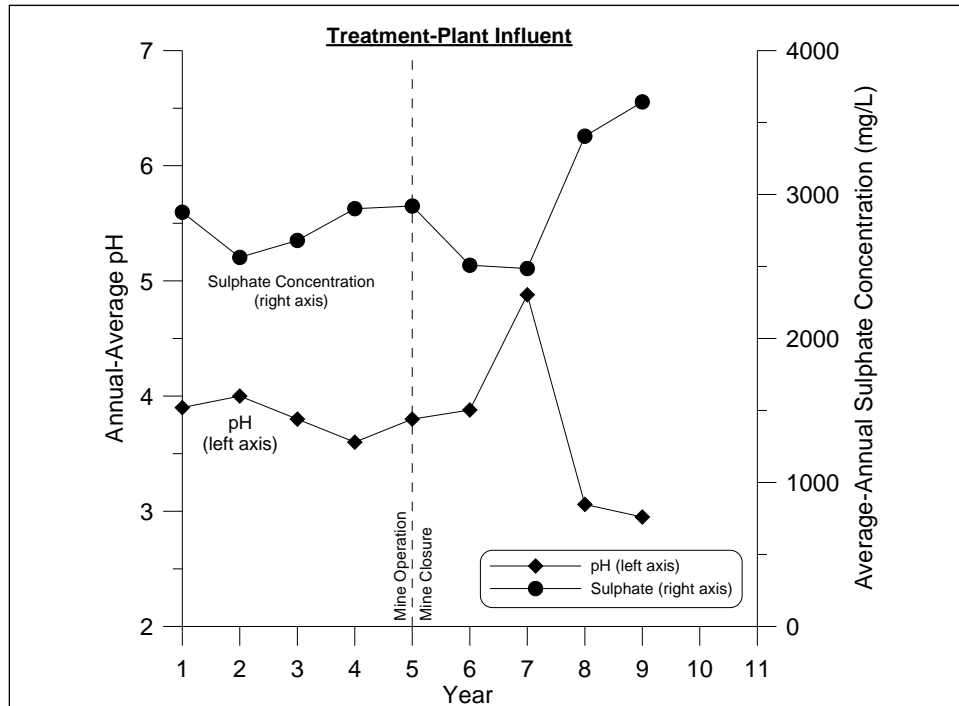
Ecological changes, such as dam building by beaver succession, may alter drainage and geochemical conditions. Changes in site management, such as decommissioning diversion ditches, or off-site activities, such as road development, may alter the rate, location and chemistry of drainage inputs. Climate events that may alter drainage chemistry include extreme runoff or drought events, and longer term climate change.

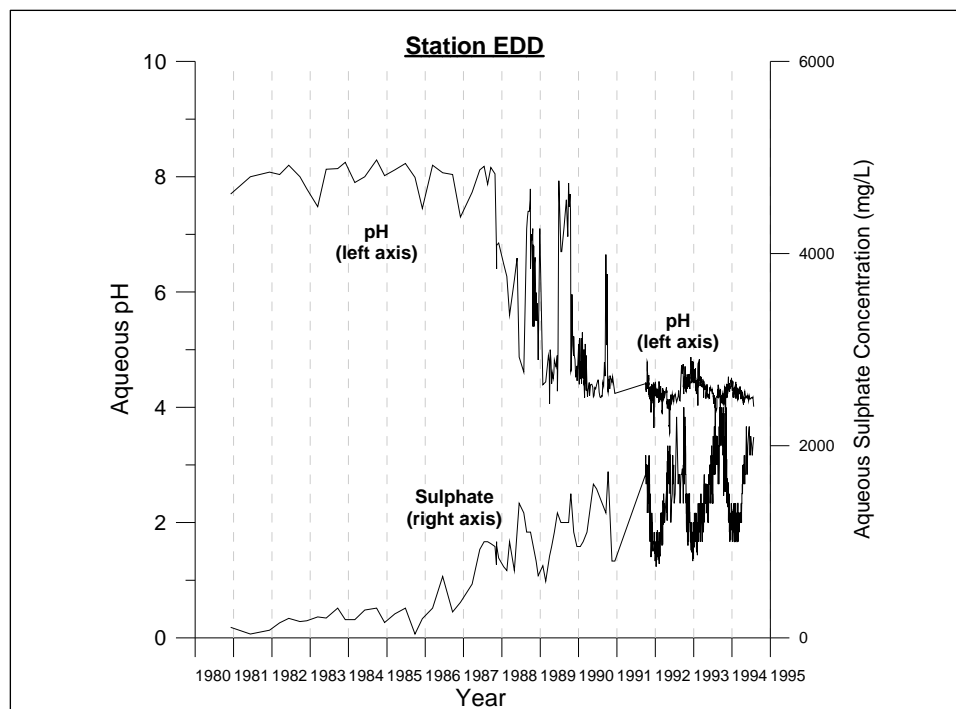
Changes in drainage chemistry due to physical and chemical weathering, changes in drainage conditions, ecological processes (e.g. plant invasion) and site management (e.g. creating or removing upslope drainage diversions) may occur almost immediately or take hundreds of years. Changes in water quality may be rapid and occur within the first few years. At some sites, there may be a slow but steady change and it may take decades or more before the complete change in drainage chemistry occurs. At other sites, the drainage chemistry may remain relatively stable for a number of years, until some geochemical or hydrogeologic threshold is crossed, causing rapid changes in some attributes of drainage chemistry. Possible mechanisms causing the rapid onset of changes include the depletion of neutralizing minerals or minerals causing galvanic suppression, overflow from mine working or changes in redox or trace metal solubility.

Consistent or improved drainage chemistry (e.g. no acidic drainage) in laboratory test work or on-site over a long period of time without evidence of the sustainability of the controlling properties and processes is not proof that drainage chemistry will not deteriorate in the future. There are many examples of sites where there have been or will be very long delays prior to the depletion of neutralizing minerals and the onset of acidic drainage. Significant changes in drainage chemistry do not stop with the implementation of mitigation measures. At the site shown in Figure 3.4a, the treatment plant built to handle the acidic drainage chemistry observed prior to closure had insufficient capacity to handle a further decline in pH and increase in acidity four years after the mine closed. The mine opened in 1971 and acidic drainage was first observed in 1988 at the monitoring site (Figure 3.4b). In this instance, the mine was still

operating and remediation measures for acidic drainage could be included in the closure plan. Hydrogeologic changes such as groundwater rebound or point sources discharges from flooded open pits may take hundreds of years.

**Figure 3.4a Post-closure decline in pH and increase in sulphate of treatment plant influent resulting in a need for more treatment capacity.**





**Figure 3.4b** The onset of acidic drainage 17 years after dump monitoring started.

### 3.9 Predict Drainage Chemistry throughout the Life of a Project

It would be important to predict drainage chemistry at all stages of a project, including:

*It is recommended that prediction continue after mine closure, as long as properties potentially influencing weathering and leaching are in flux, and there is significant uncertainty regarding drainage chemistry.*

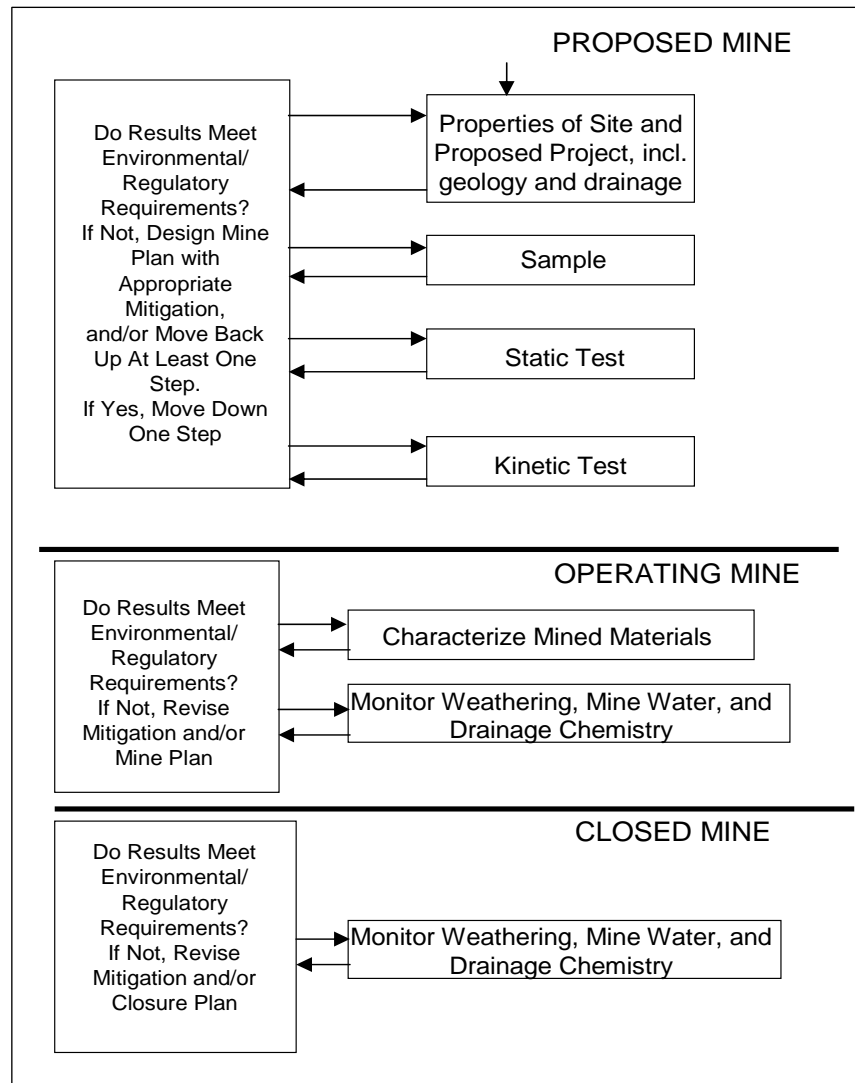
exploration, project planning, construction, mining and processing, closure and post-closure (see Chapter 4). The prediction questions, information requirements and

prediction materials and methods may change with each stage. Prediction of future drainage chemistry should be part of mine planning to ensure the necessary mitigation measures are included in the advanced exploration, operating and closure plans. Verification of those predictions and additional studies to resolve uncertainties in the closure plan should occur during construction, mining, processing and after the mine closes. It is recommended that prediction continue after mine closure, as long as properties potentially influencing weathering and leaching are in flux and there is significant uncertainty regarding drainage chemistry.

Predictions regarding future drainage chemistry should be updated whenever there are major changes to the project or site conditions to ensure that the understanding, mitigation plans and financial and human resources remain sufficient to protect the environment. Major changes to the project include modifications to the mine or the mine plans that may significantly alter the drainage chemistry. Changes to site conditions include significant changes in weathering, drainage conditions and drainage chemistry.

### 3.10 Continue Prediction if there is Significant Uncertainty

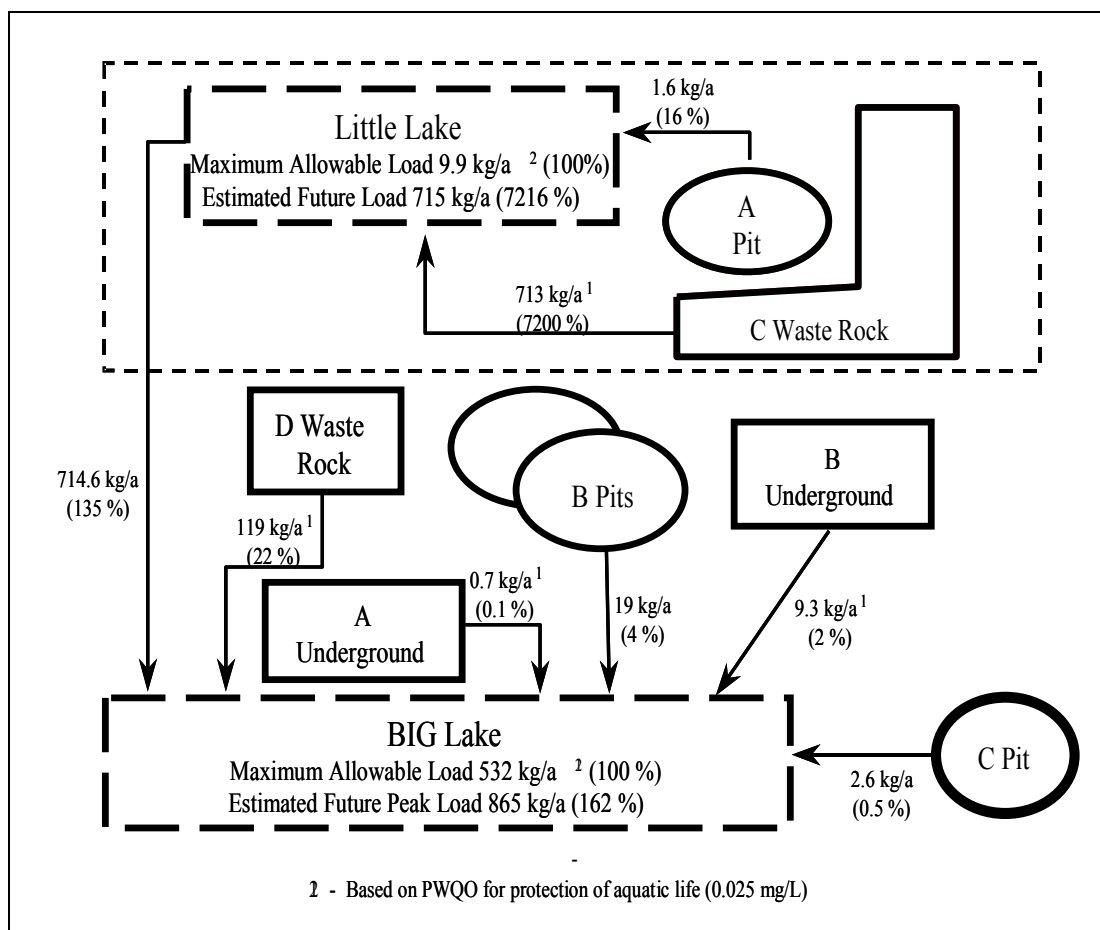
It would be important for prediction to continue for as long as there is significant uncertainty regarding future drainage chemistry and a potential need for the proactive detection and resolution of drainage chemistry problems (Figure 3.5). Significant uncertainty regarding weathering, the impact of climate on leaching and a need for prediction are likely to continue for the foreseeable future at mines with drainage chemistry concerns.



**Figure 3.5** A schematic depiction of the prediction of drainage chemistry throughout the life of the project.

### 3.11 Consider the Impact of the Project as a Whole

While the initial interpretation of results is done on individual geologic units and project components, the final evaluation should include an assessment of the drainage chemistry and environmental impact of the project as a whole (Figure 3.6). It is important to recognize that the objective is to minimize cumulative impact, liability and risk, prevent environmental impacts and meet regulatory requirements of the project as a whole. Conclusions regarding the predicted drainage chemistry for individual project components may change after the materials handling and mitigation options and the cumulative risk, liability and land use impact of the entire project have been reviewed.



**Figure 3.6 A model of trace element loadings from different project components and their relative impact on the allowable load in the receiving environment. (Ron Nicholson, Ecometrix, personal communication).**



### 3.12 Take a Scientific Approach

The prediction of drainage chemistry requires a scientific approach which includes the following.

- Ensure that performance indicators are measurable, verifiable and reportable.
- Select samples for analysis and kinetic tests that are spatially, geologically, physically and geochemically representative and include the fractions, location and events of most concern.
- Check that the assumptions associated with sampling, sample preparation, analytical methods, test procedures, calculated parameters and the interpretations of results are correct.
- Do not extrapolate beyond the duration or spatial locations for which there is evidence.
- Present all plausible outcomes, hypotheses or mechanisms, not just the initial, most favoured, worst or the most easily managed explanation of results.
- Show how the proposed explanation(s) or mechanisms (hypotheses) may be verified if correct or proven wrong if incorrect or only partially correct.
- Clearly define the terminology used for properties and processes (see the Glossary).

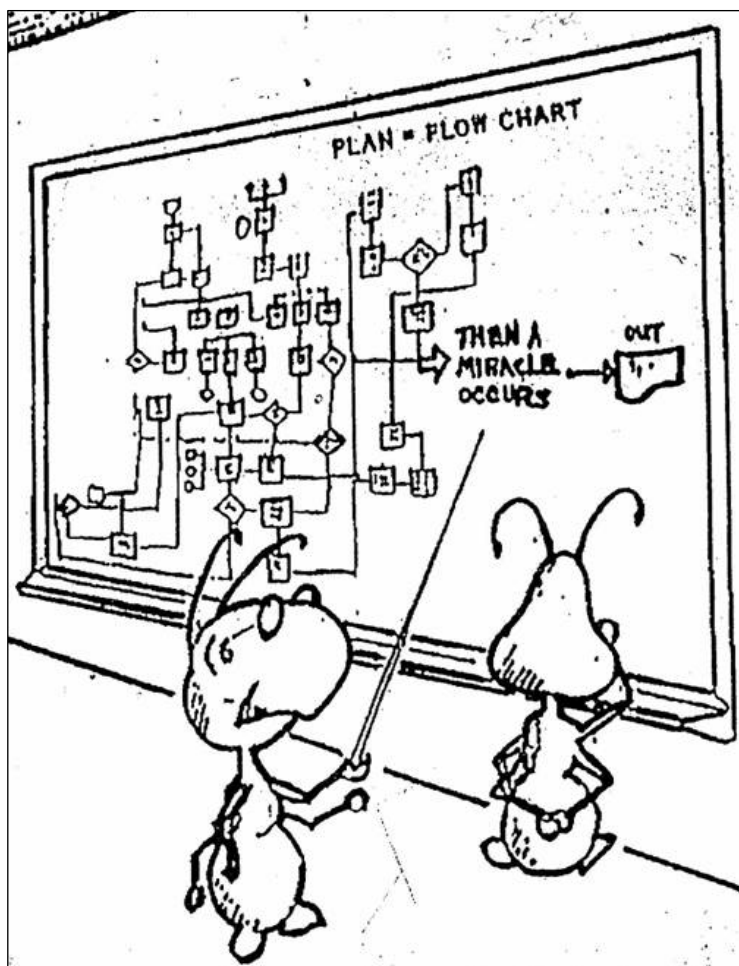
Drainage chemistry prediction should be based on comprehensive, verifiable information. No amount of QA/QC, statistics, computer modeling and expert opinion will help if sampling and analysis miss the key:

- locations (e.g. pyrite halo potentially intercepted by the edge of the pit);
- materials (e.g. the heavy and larger particles that are deposited separately on the tailings beach);
- properties (e.g. presence of iron carbonate);
- processes (e.g. reductive redox dissolution); or
- sequence of events (e.g. oxidation followed by reductive dissolution).

Although they may prove very useful, many past errors in the prediction of drainage chemistry have resulted from the substitution of optimistic professional judgment and computer models for a scientific assessment of the contributing properties and processes, the timing of events or material variability (Figure 3.7).

Examples of a scientific approach in checking whether assumptions in material characterization are correct include periodically testing that:

- samples of exploration drill core or pre-blast drill cuttings have similar composition to waste rock fines;
- samples of whole tailings have similar composition to tailings beach and slimes; and
- samples taken at regular intervals have similar composition to material in between these locations or dates.



**Figure 3.7 QA/QC, statistics, computer modeling and expert opinion cannot substitute for sampling and analysis of the key properties, materials, events and locations.**

A great number of factors can influence drainage chemistry prediction practices. In addition

*A great number of factors can influence drainage chemistry prediction practices. In addition there is often some uncertainty about the materials, properties and processes.*

there is often some uncertainty about the materials, properties and processes. It is therefore important to document the rationale for predictions and gaps in the evidence. Where no further work is required on an item, such as material characterization, it is important to explain why.

### 3.13 Deal with Uncertainty and Gaps in the Prediction Data

Some degree of uncertainty regarding future drainage chemistry occurs at all sites (Figure 3.8). Addressing this uncertainty is one of the most important prediction tasks in developing remediation and closure strategies. This includes deciding when the accuracy and precision is adequate, recognizing gaps in the prediction data that result in significant risk and having corrective actions, where necessary.



**Figure 3.8** There is significant uncertainty regarding some aspects of drainage chemistry at most major precious and base metal mines and many coal mines in Canada (photo of Kitsault Mine in northwest British Columbia).

Uncertainty and gaps in predicted drainage chemistry may result from the following.

- There may be errors and omissions in previous material characterizations.
- A large number of properties and processes potentially influence drainage chemistry.
- Many influential properties and processes are in flux (e.g. mine plans).
- There are complex interactions among contributing properties and processes.
- There is a need to predict over long time frames and widely ranging climatic conditions.
- There may be limited knowledge of the rates for many potentially important processes (e.g. the rate at which silicate minerals neutralize acidity produced by pyrite oxidation).
- It is difficult to measure some properties and processes.
- Standard calculations may include potentially inaccurate assumptions about the contributing properties and processes (e.g. all the inorganic-C is assumed to be calcite).
- There is subjectivity in some analyses and tests (e.g. the fizz test in the Sobek Neutralization Potential, Chapter 13).
- There is a lack of long term data on weathering and drainage chemistry from well-characterized materials that can be used as bench marks.
- Every site has a unique combination of geologic materials, site conditions, project components and environmental protection requirements.
- It may be difficult or impossible to obtain representative samples and monitor some areas of excavations or excavated materials (Figure 3.9).



**Figure 3.9 Many key properties and processes, such as weathering of mine wastes under this soil cover at the Equity Silver Mine, are difficult to measure let alone predict. (photo of Equity Silver Mine in northwest British Columbia from Mike Aziz, Goldcorp Canada Ltd.).**

Prediction tests and standard calculations may simulate certain processes but they are unable to completely duplicate all field conditions. A property that depends on a large number of processes, such as the neutralization potential, may be inaccurately measured by simple analytical procedures developed to provide information in a timely manner. “Blind spots”, and potentially erroneous assumptions, simplifications and generalizations in analyses, tests, calculations and standard interpretations of data, should be identified and considered in the selection of test procedures and in the interpretation of the results.

*Prediction tests and standard calculations may simulate certain processes but they are unable to completely duplicate all field conditions.*

One way to improve the accuracy of the resulting prediction is by conducting analyses or tests that measure similar properties (e.g. carbonate-NP versus bulk-NP). Discrepancies in the results of overlapping or complementary tests may indicate that there are problems in the “blind spots” or uncertainties in one or both tests that require further analysis (e.g. significant contribution of Fe or Mn carbonate to the measured NP). Many static tests recommended in this Manual provide complementary, somewhat redundant information that provide valuable cross checks on predictive information. Complementary tests may also be used to check for analytical errors and select cost-effective means of operational sample characterization.

*Discrepancies in the results of overlapping or complementary tests may indicate that there are problems in the “blind spots” or uncertainties in one or both tests.*

A common cause of gaps in prediction data is a lack of representative samples or monitoring data for some areas of the site (Chapter 8). Prior to mining, representative samples of drill cores for

material characterization are often not available from the deepest parts of the proposed excavations or in the waste at the edges of the mine workings because there has been no drilling in these areas. Once portions of a pit or underground workings close, access is no longer maintained and it may be impossible to collect weathered samples or to monitor drainage from inaccessible areas.

Prior to mining, it is difficult to predict the physical effects of excavation, processing and deposition on the chemical composition of different size fractions or areas of the waste, such as the < 2 mm fraction of waste rock, tailings slimes and the heavier, coarser portion of the tailings deposited on tailings beaches. Once waste rock dumps have been constructed, it is difficult to sample the buried material without breaking particles, exposing fresh surfaces and masking the impact of weathering.

Another potential source of inaccuracy is significant differences between the test conditions and the field conditions of the materials of concern. These differences may include:

- climate differences (e.g. laboratory climate versus that in the field);
- edge effects (e.g. less heat retention in a field test pad compared to the center of a waste rock dump);
- scale differences (e.g. less particle size segregation in a field test pad compared to a large waste rock dump face or tailings impoundment); and
- differences in the solid to water ratio (e.g. trickle leach column compared to a waste rock dump).

Sensitivity and gap analyses should be conducted after every phase of a prediction program to determine the adequacy of sampling, sample characterization, data analysis and interpretation and the impact of possible inaccuracies or lack of precision on the overall environmental risk and liability. Results of sensitivity and gap analysis can be used to determine:

- operational material characterization, excavation, material handling, mitigation and monitoring requirements;
- where more accurate prediction information could result in lower cost or lower risk mitigation measures;
- where supplemental or contingency mitigation measures may be necessary; and
- regulatory conditions for project approval, operation and post-closure.

The conclusions of the sensitivity and gap analysis will depend on the available information and can be used to determine precautionary conditions, contingency measures or additional studies required to address significant information gaps. Examples of additional monitoring to check assumptions include:

- periodic nested sampling in between regular sample locations to check the sampling density;
- sampling of the reactive materials after blasting, processing and deposition to compare with material characterization results based on analysis of pre-blast drill cuttings;
- field test pads to check the predicted drainage chemistry for borderline material; and
- piezometer installation to check the predicted height of the water table.

### 3.14 Be Prepared for Changes to the Mine Plan

Be prepared for changes to the original project and mine plans. Mine plans are dynamic entities continually being modified to adapt to changing economic conditions, ore grades, ore reserves, ground conditions and the costs of construction, mining and processing. Mine plan changes during the life of a project typically include the location, the size and/or composition of mine walls, waste materials and mine components and the timing of activities such as mine closure.

*Mine plan changes during the life of the project typically include changing the location, size and/or composition of mine walls, waste materials and mine components and the timing of activities such as mine closure.*

Fluctuating commodity prices always create uncertainty about the full extent of a mining project and the final composition of the wastes and mine walls and their drainage chemistry. If there are improved mining methods, better than predicted ore grades or improved commodity prices, mine workings may expand into materials outside the zone of previous characterization. Conversely, mines may close prematurely leaving low grade ore, which was to be processed and flooded, in aerial waste piles.

Comprehensive prediction information, including detailed characterization and a good understanding of the future weathering of the sulphidic geologic materials, provides a company with the necessary information to determine the impact of proposed modifications of the mine plan on the future drainage chemistry and the resulting mitigation requirements.

### 3.15 Clearly Identify Materials and Methods

Small differences in sampling, sample preparation, analytical procedures and data interpretation may cause significant differences in the prediction results. It is therefore very important to describe in detail the sampling methods, the materials that were analyzed, where discrepancies occurred and where methodologies differed from referenced or standard laboratory procedures. Consistency in test procedures is important when comparing results and attempting to learn from previous experiences with similar materials.

One of the findings in reviewing prediction practices to produce this document was that it is not uncommon for laboratories to modify standard analysis procedures and methods for sample preparation.

### 3.16 Use Clearly Defined Terminology

The reporting and interpretation of drainage chemistry prediction results should:

- clearly define terminology and acronyms;
- clearly define methods used to derive test results and calculated parameters; and
- identify the analytical procedures used to determine broadly defined parameters, such as acid generation potential (AP) and neutralization potential (NP).

A good way to do this is to include a glossary of terminology, acronyms and methods (see the Glossary).

Challenges in creating a glossary and communicating the results of drainage chemistry prediction include the:

- multidisciplinary, multi-faceted nature of the work;
- lack of standard definitions even between practitioners within the same jurisdiction;
- large number of acronyms;
- lack of direct measurements for key parameters such as neutralization potential; and
- misleading use of terms such as humidity cell and paste pH.

Accurate and precise terminology requires the provision of different terms to distinguish:

- different properties (e.g. the distinction between acid generation from sulphide oxidation and the generation of net acidic weathering conditions and acidic drainage resulting from the balance between acid generation and acid neutralization);
- different scales (e.g. the distinction between micro-scale and the larger scale geochemical conditions or drainage chemistry);
- measurements made on different types of samples, after different sample preparations (e.g. paste pH versus rinse pH) or different laboratory analyses (e.g. the various forms of acid potential); and
- laboratory measurements from predicted properties and processes (e.g. separate terms and definitions for effective field neutralization potential, unavailable neutralization potential and the various laboratory neutralization potential measurements).

A disadvantage of increased precision in the terminology used to describe the prediction phenomenon is the proliferation of cumbersome prefixes. This is an unavoidable consequence of the large number of contributing properties and processes and analyses. Acronyms and units of measure should be defined, along with materials and methods at the start of any drainage chemistry prediction report.

### 3.17 Identify the Intended Uses of Prediction Analyses and Test Work

Prediction work should have clearly defined and realistic objectives (see Chapter 2 and Section 3.12). Before proceeding with the

*Prediction work should be cost effective and have realistic, clearly defined objectives and not merely raise further questions. When evaluating test results, it is important to consider all potentially influential properties and processes and identify all potential hypotheses.*

sampling, analyses and other test work, it is important to identify the prediction question(s) and how they will be answered. The intended uses for prediction information will then guide the data requirements, selection of samples, analytical procedures and

the manner in which results will be interpreted.

The kinds of questions will depend on factors such as:

- regulatory, community and corporate requirements;
- environmental, remediation, reclamation and mitigation requirements at each stage of the project (e.g. exploration, project proposal, operating, closure and post-closure);
- the type and distribution of different geologic materials and whether they are already weathered;
- whether acid rock drainage (ARD) is already present, probable, unlikely or uncertain;



- excavation, materials handling, deposition and mitigation methods and options, types of wastes and depositional environments; and
- existing information.

An evaluation of potential mining actions, environmental objectives and potential mitigation strategies will be useful in identifying information gaps and developing a prediction program that serves the needs of the site as a whole. For example, a site that is already collecting and treating acidic drainage may want to predict the probable maximum acidity to ensure the treatment program has sufficient capacity and financial resources. A new mine may want to segregate potentially problematic drainage generating wastes from wastes where drainage chemistry is not predicted to be a concern. This would minimize the cost of the flooded impoundment for the potentially problematic waste and allow the use of the benign wastes for construction.

The different geology and mining methods of a coal mine may result in different prediction methods than a hard rock mine. For example, the vertical layering and the horizontal continuity of the geology and differences in the depth of excavation should be considered in the size and location of samples. The presence of organic carbon and sulphur should be considered in the selection of analysis procedures. Notably, these may also be properties of hard rock mines; therefore, the key message to keep in mind is that one needs to tailor prediction methods to site specific conditions.

To maximize the effectiveness of the prediction work, it would be important for the proponent to identify all management decisions requiring prediction information as soon as possible (Chapter 2). As knowledge increases regarding the geologic materials and mine components and their performance and mitigation, the questions may change or become more refined.

### 3.18 Consider the Cost-effectiveness of Additional Test Work

Prior to initiating each phase of test work, it is important to consider the purpose and likely management impact of the results and to continually check the relevance of prediction to the overall objectives. Prediction work should have realistic, clearly defined objectives and not merely raise further questions. Additional prediction should be done if it is likely to significantly:

- improve ore recovery, waste handling and mitigation; or
- reduce the environmental risks and liability.

Some uncertainty and gaps regarding future drainage chemistry are inevitable. At some point, a conservative design, adaptive management and mitigation will be more effective ways to deal with uncertainty and gaps than prediction alone. For example, contingency mitigation measures coupled with operational testing during mining may be a more attractive option than additional pre-mining prediction test work, if the latter may be inconclusive or of

*At some point, conservative design, adaptive management and mitigation will be more effective ways to deal with uncertainty and gaps than prediction alone.*

limited significance to the overall project plan.



In drainage chemistry guidelines, mitigation and prediction are usually discussed separately (Price and Errington, 1998). In practice, the two should be closely integrated, with the results of one informing the other.

### 3.19 Use a Phased Approach

The large number of potentially influential properties and processes, complex interactions and

*The most cost-effective way to predict and manage drainage chemistry is an iterative process of data collection and interpretation, similar to that used to determine other geologic characteristics such as ore reserves.*

properties in flux can make the prediction of drainage chemistry an onerous undertaking. Commonly, the most cost-effective way to characterize project components, predict their potential drainage chemistry, create management units and determine their disposal needs will be an iterative process of

data collection and interpretation, similar to that used to determine other geologic characteristics such as ore reserves.

A phased approach to data collection and interpretation should ensure the prediction program:

- focuses on the materials and issues of greatest concern;
- minimizes work on materials with no significant uncertainty;
- uses the most appropriate test materials and procedures; and
- makes timely refinements in response to unforeseen conditions.

At each phase, it is important to review the existing information and check whether the proposed sampling, analyses and test procedures will still answer the site specific prediction questions. Based on the results of the previous sampling and analysis, it may be necessary to refine prediction questions, subdivide or lump together geochemical units, add new samples or modify the test procedures.

In a phased test program, results from cheaper test procedures conducted on a large number of samples can be used to select representative samples for more expensive test procedures (e.g. humidity cell, Chapters 9 and 18). This reduces costs and ensures that more expensive, time consuming tests are conducted on the required materials. Examples of this include the use of geologic mapping and static testing to select samples that are spatially and geochemically representative for kinetic test procedures and the use of static and kinetic test work to determine whether more expensive sub-microscopic mineralogical determinations are needed.

### 3.20 Get Started as Soon as Possible

It is important to get started as soon as possible to allow sufficient time for a cost-effective, *Get started ASAP!* phased prediction program, for time consuming kinetic test work to be performed and to ensure results are available to proactively resolve any environmental problems that may be encountered. By starting each phase of a prediction program and initiating kinetic tests as soon as possible, delays in project planning and regulatory review will be minimized if there are unforeseen problems requiring further data collection. Regulatory conditions for material handling and waste disposal may be unnecessarily

conservative if a project lacks the data to show how problems associated with less conservative approaches may be avoided.

### 3.21 Avoid Past Errors

Most past errors have resulted from failures on the part of practitioners to follow proper procedures and consider all the potentially contributing properties and processes, rather than from gaps in basic knowledge (Price et al., 1997). Errors in prediction have resulted from failure to:

- adequately characterize samples;
- conduct the analyses or tests properly;
- select the appropriate test and correctly interpret test results (e.g. humidity cells or shake flasks used incorrectly to predict solubility constraints);
- check the assumptions in the tests and data analysis;
- test all geologic materials, mine components (e.g. material used for dam construction), waste components (e.g. different tailings fractions) and areas of excavation or exposure (e.g. waste rock at the edge of a newly planned pit expansion);
- check all potentially influential properties, processes and interactions and identify all potential explanations for the observed effects;
- recognize that many properties and processes are in a state of flux and conditions may change;
- conduct kinetic tests on samples whose composition is representative of the material of concern (e.g. the material with the lowest NP or highest sulphide content);
- provide adequate resources to conduct the required analyses and tests; and
- conduct studies that address the management questions and are compatible with project development or remediation timelines.

Some prediction tests have very specific procedural and interpretation requirements. For other

*Practitioners need to recognize and understand limitations in the precision and accuracy of prediction tools.*

tests, the procedure and interpretations depend on the information requirements and site conditions. Practitioners need to recognize and understand limitations in the precision and accuracy of sampling, sample preparation, analyses, test procedures and methods used to interpret data. This is a challenge because drainage chemistry prediction has multi-disciplinary information requirements. In addition to drainage chemistry prediction specific technology, drainage chemistry prediction can include aspects of geology, rock weathering, environmental geochemistry, hydrology, metallurgy, mining engineering and geotechnical engineering.

### **Examples of Errors in Drainage Chemistry Prediction**

**Mine A:** Using total-S to calculate the acid potential (AP) and the average ABA results, all waste rock and tailings were initially classified as potentially net acid generating.

The geochemistry of the rock was quite variable and contained significant sulphate-S that was gypsum, resulting in a large over estimation of AP. Using total-S to calculate the acid potential (AP) and the spatial variability in ABA results, only 40% of waste rock type 1 and 80% of waste rock type 2 were predicted to be potentially net acid generating which significantly reduced the costs and area required for mitigation. Using sulphide-S rather than total-S to calculate the acid potential (AP), the tailings were predicted to have NPR around 8:1 and thus there was no need for additional sulphide removal circuits in the mill.

**Mine B:** Waste rock was initially predicted to be net neutral based on:

- visual assessment that the waste rock contained little or no sulphide minerals;
- the sub-alpine climate was not conducive to weathering; and,
- sulphide minerals on exposed surfaces appeared to have not reacted.

Subsequent sampling and analysis of the waste rock and surrounding area indicated:

- the waste rock had 2 % to 20 % sulphide-S and NPR values of less than 0.4;
- one area of waste rock already produced drainage with a pH of 3;
- net neutral pH conditions in the rest of the waste rock dumps resulted from a neutralization potential of 18 to 40 kg/tonne; and
- leachate from a natural sulphidic outcrop above the mine had a pH of less than 3.

**Mine C:** The ARD generating dumps were phyllic-altered material, with little or no NP and an average of 3% sulphide-S. Waste rock dumps that produced neutral drainage contained 0.5 to 4% sulphide-S, had an NP of 10 to 30 kg/tonne and for the most part an NPR < 1. An initial assessment using a proprietary model concluded that the worst drainage chemistry had already occurred. No explanation was provided as to why the computer model contradicted the results of the static and kinetic test work which suggested that most of the neutral pH dumps would eventually produce ARD, increasing metal loadings and acidity. The mining company was unable to support the conclusion of the proprietary model and had to pay for a reinterpretation of the static and kinetic test work.

**Mine D:** Test work conducted on two metallurgical samples prior to mining indicated that the tailings had an NPR > 2. This resulted in the tailings being classified as net neutral not requiring mitigation and the company constructing a porous tailings dam. Subsequent characterization showed that the tailings had sulphide-S higher than 1%, an NPR well below 1 and predicted to eventually be net acid. This has resulted in significant additional unplanned post-closure costs for studies and mitigation.

### 3.22 Use Properly Qualified and Responsible Personnel

The length of and level of detail in this Manual reflects the level of knowledge required of those conducting prediction programs for major mines. Properly qualified personnel should be responsible and accountable for the terms of reference for drainage chemistry prediction work, selection of materials and methodology and the interpretation of results. Qualifications include having the proper experience and the appropriate technical training.

To ensure responsibility and accountability, protocols for prediction work should identify the person or persons responsible for each phase and task of the program. Responsibility and accountability should also be identified for the subsequent interpretation, reporting and action taken, based on the results. An important part of this is identifying both the persons who provide direction and those who conduct the work and make operational decisions.

Drainage chemistry prediction requires basic understanding and experience in a wide range of

*Drainage chemistry prediction requires basic understanding and experience in a wide range of technical disciplines. Usually no one individual has the background and experience in all the required areas of understanding. A team approach is required and good communication between the persons working on the project is important.*

technical disciplines, including mining, geology, weathering, hydrology, hydrogeology and environmental chemistry, in addition to a thorough understanding of drainage chemistry prediction procedures, the project, site conditions and the geologic materials. Usually no one individual

has the background and experience in all of the required areas of understanding and portions of the work must be conducted by different specialists. A team approach and good communication between the persons working on the project is important. All those involved should be properly informed (e.g. person conducting sample preparation or fizz test). It is also critical that the project manager stay well-informed, so that he or she can set the terms of reference, implement results and make the correct decisions regarding whether additional work is required.

An important part of being properly trained is keeping up with new developments. While many of the methods used in the prediction of drainage chemistry, such as the Sobek procedure (Sobek et al., 1978), are relatively old, a general awareness of their limitations and “blind spots” during each stage of a project is relatively new. Field verification of results is limited and new studies are continually adding to our understanding of this topic. Consequently, there is a continually need for practitioners to upgrade their knowledge.

### 3.23 Provide Adequate Personnel and Resources

Both governments and companies need to ensure they have adequate personnel and resources for dealing with the prediction of drainage chemistry for mine and closure planning. Conducting all the site investigations, sampling, analysis, test work and assessments will require considerable time and money. Gaining the necessary understanding of the project history, drainage chemistry data and previous performance needed to regulate the drainage chemistry aspects of a mine site will take regulators considerable time. Keeping up with the modifications to project plans and

with the changes to project and site conditions will be a challenge for both industry and regulators.

The following are some of the challenges in providing the industry and government considerable time and money needed to sustain the collection and review of drainage chemistry information.

- There is a cumulative increase in the number of mine sites with prediction needs (e.g. Table 3.2). This is due in part to significant uncertainty regarding weathering and leaching and an ongoing requirement for prediction of future drainage chemistry mitigation requirements at most closed mines with sulphidic geologic materials.
- Where drainage chemistry problems will not occur for a number of years or the potential for problems is uncertain, the funding for drainage chemistry prediction may lose out to more immediate problems or optimistic scenarios.
- Cut-backs are made to corporate and regulatory resources and personnel as part of periodic cost cutting when cyclical down turns occur in commodity prices. Financial decision makers are likely to be unaware of the implications of cuts in prediction work.
- Considerable determination, stamina and technical understanding is needed to predict drainage chemistry and keep up with frequent changes in contributing properties and processes at complex mine sites.
- Future drainage chemistry at operating and closed mines is not a topic that catches the attention of the general public.
- While there are increasing resources for organizing reviews and meetings about drainage chemistry, there is little or no increase in resources for the personnel predicting drainage chemistry.
- Most of the mine sites that need to predict future drainage chemistry are no longer operating and produce no revenue.

While the effort required in prediction may seem onerous, the costs are minimal compared to the tens of millions of dollars for remediation and impacts that may last for decades, centuries, or millennia due to inadequate understanding of the future drainage chemistry. Inadequate predictions hurt the industry as a whole and the communities that depend on sustainable mining and the impacted resources.

**Table 3.2 The cumulative increase in major mines with an ongoing requirement for prediction of future drainage chemistry in British Columbia.**

<b>Major Mines with Requirement for Prediction of Future Drainage Chemistry</b>	<b>Number</b>	<b>Cumulative Number</b>
Historic	10	10
Closed 1970-1990	18	28
Recently Closed	20	48
Operating	12	60

### 3.24 Maintain a Data Base of Materials, Methods, Results and Relevant Properties of the Project and Site

Major challenges in drainage chemistry prediction are sustaining industry, regulatory and

*A major challenge in drainage chemistry prediction is sustaining industry, regulatory and community memory of the prediction materials, methods and results.*

community memory of the prediction materials, methods and results and sustaining the understanding of other relevant properties of the project and site. Maintenance of industry, regulatory and community interest and understanding of prediction data is

strained by the:

- detailed, multidisciplinary, multi-faceted, highly technical nature of the work;
- time required to understand complex mine sites and keep up with trends in a very large number of potentially influential properties and processes;
- large amounts of jargon and acronyms; and
- potentially long time frames until events of concern occur.

Sustaining industry, regulatory and community understanding becomes even harder when there are:

- changes in individual involvement;
- changes in ownership or reporting structures;
- cut-backs in resources or personnel; and
- transitions from one stage of a project to another (e.g. project planning to construction to active mining).

Maintaining previously generated data and other relevant site information in an accessible form that facilitates regular review and tracking of changes is extremely important to successful long term prediction of future drainage chemistry. Currently, most projects have their prediction information in a mix of documents and monitoring data bases, reports and plans undertaken to fulfill specific internal or regulatory requirements. Usually, these documents and data bases focus on specific issues or aspects and do not provide holistic coverage of the whole mine site or life of the project. Typically, only one or two individuals know many of the details regarding site history and previous data collection or keep track of changes in drainage chemistry and the properties that impact drainage chemistry.

Eventually, people move on and reports can be lost. For example, key site personnel may retire

*Operational characterization of wastes, drainages and mine walls may include thousands of analyses and hundreds of thousands of dollars of work. All this work and money may be wasted if details such as sample locations, sampling methods, analysis procedures and analytical results are lost.*

or leave in anticipation of mine closure. Without an adequate data base, staff changes or neglect can result in the loss of knowledge or records about previous activities, what information exists, how it was collected and where it is stored. Operational characterization of wastes, drainages and mine walls may include thousands of analyses and hundreds of

thousands of dollars of work, much of which may be wasted if details regarding the data, such as sample locations, sampling methods, analysis procedures and analytical results, are lost.

Information that needs to be saved in central databases includes the following (see Chapters 6 and 7):

- general and background properties of the project and site collected as part of Step 1 of a prediction program, such as: data on landforms, climate, fish populations, metal levels in fish, soils and vegetation and regulatory, community and corporate needs for environmental protection and reclamation;
- drainage conditions such as: the height of the water table and location, water quality and rate of flow of surface water courses and near surface seepage;
- geologic information such as: differentiation, description and mapping of bedrock and soil units that will be or have been excavated, exposed or otherwise disturbed;
- data on mine components including: locations, description of methods of excavation, processing and waste handling and deposition, as-built plans showing the location, mass, spatial differences in composition and hydrology and any other features that impact weathering of the resulting mine components;
- site plans and maps of mine components, topography and drainage features;
- results from all pre-mine, operational and post-closure material characterization, test work, monitoring of drainage chemistry, weathering of different project components, flow and other parameters (e.g. temperature and oxygen levels) for monitoring wells, individual seepages, discharge locations and the receiving environment and excavated, exposed and disturbed geologic materials;
- materials and methods for present and past prediction methods including:
  - protocols for monitoring, sampling, analysis, test work and QA/QC,
  - roles, responsibilities, qualifications and training needs of personnel;
  - equipment for monitoring, sampling, analyses and test work,
  - sample size, frequency, storage, transportation and preparation prior to analyses and test work, and
  - protocols for storage, presentation and reporting of results
- regulatory requirements and conditions, including: discharge, monitoring and reporting requirements;
- any significant uncertainty and gaps and the resulting risks and corrective actions; and
- costs.

The information should be preserved in a safe, secure and usable form that allows:

- the tracking of changes to key properties or components of the site;
- qualified persons, unfamiliar with the site, to take over and successfully continue to implement the prediction and waste characterization programs; and
- the information to be regularly reviewed and updated and accessible for the management of the site.

Unfortunately, where resources are short, data management and review are often the first things to be dropped, especially if problems are unlikely to occur for a number of years. Providing sufficient resources to maintain, update and review monitoring records is an important part of successful database management. Databases should be organized so that new information can be easily added. Regular review of the data is required to ensure adequate data quality not just for the evaluation of the results.

### 3.25 Be Prepared to Act on the Prediction Results

Prediction can be a call to action, but on its own cannot prevent impacts. Adaptive management and the implementation of contingency plans based on prediction will only prevent impacts if they are well prepared and there is sufficient time, resources and information about what corrective measures are required.

*Prediction can be a call to action, but on its own cannot prevent impacts.*

### 3.26 Act Safely

Health and safety requirements should be primary considerations in any prediction program. Proposed, active and closed mine sites contain a number of potential hazards for persons monitoring or inspecting site conditions. These include:

- steep and unstable ground conditions;
- large equipment;
- blasting;
- potentially poor air quality within mine workings and mine wastes and associated monitoring locations;
- process chemicals; and
- remoteness of many sites.

It is important to be familiar with the potential hazards on the site and take the proper precautions before conducting prediction activities. This includes becoming familiar with the mining and exploration activities and informing the necessary site personnel of your activities. The need to be aware of the hazards and take the proper precaution is highlighted by the recent deaths due to poor air quality in a confined drainage monitoring sump below a sulphidic waste rock dump (Phillip and Hockley, 2007).

### 3.27 Review the Details of the Sample Results and Materials and Methods

It is important to remember that the “devil is typically in the details” in drainage chemistry prediction. While it is easy to get lost in the details and lose sight of the overall objectives, it is equally important to remember the specific requirements and assumptions of the sampling and analysis procedures and not misuse or misinterpret the results.

*The “devil is typically in the details” in drainage chemistry prediction. Raw data should always be included in prediction reports along with the resulting interpretations.*

In these busy times, many will only read the executive summary of a drainage chemistry prediction report. However, a proper understanding of the accuracy of the work or the resources required to conduct that work can only be achieved by reviewing the details regarding site conditions, sampling, sample preparation, analyses, test procedures and the interpretation of data. Unavoidably, this requires one to review the raw data.

Individual sample results should be reviewed before calculating descriptive statistics. Raw data should always be included along with the resulting interpretations in a prediction report.



### 3.28 References

Condon, P.D. 1999. Characterization and Prevention of Acid Rock Drainage Processes at the Greens Creek Mine, Admiralty Island, Alaska. University of Oregon. Ph.D. dissertation. Eugene, Oregon.

Kennecott Greens Creek Mining Company (KGCMC). 2003. Inactive Production Rock Sites and Quarries 2002 Annual Report. Section 3 of the report discusses static ABA testing and some water chemistry from quarries used for various construction projects around the site. <http://dnr.alaska.gov/mlw/mining/largemine/greencreek/index.htm>

Martin, A.J., J.J. McNee and T.F. Peterson. 2001. Post-Closure Mobility of Arsenic in Mine-Impacted Lake Sediments. In: Proceedings of 8th Annual British Columbia Ministry of Energy and Mines (MEM) - MEND Metal Leaching/ARD Workshop, New Developments, Different Aspects of Prediction and the Use of Water Covers as a Mitigation Strategy. Vancouver, British Columbia, November 28-29.

Morin, K.A. and N.M. Hutt. 2004. Equity Division – Review of 2003 ARD and Assessment of ARD Mechanisms. Prepared for Mike Aziz, Equity Division, Placer Dome Canada.

Phillip, M. and D. Hockley. 2007. Sullivan Fatalities Incident Technical Investigations and Findings. In: Proceedings of the 14th Annual BC-MEND ML/ARD Workshop, Challenges in Collection and Treatment of Mine Drainage. Vancouver, British Columbia, November 28-29.

Price, W.A. 2005. Case Studies of ML/ARD Assessment and Mitigation: Snip Gold Mine. MEND Report 9.1c.

Price, W.A. and J. Errington. 1998. Guidelines for Metal Leaching and Acid Rock Drainage at Minesites in British Columbia, British Columbia Ministry of Employment and Investment (currently BC MEMPR). p. 86.

Price, W.A., J.C. Errington and V. Koyanagi. 1997. Guidelines for the Prediction of Acid Rock Drainage and Metal Leaching for Mines in British Columbia: Part I. General Procedures and Information Requirements. In: Proceedings of the Fourth International Conference on Acid Rock Drainage, Vancouver, British Columbia, May 31-June 6, 1997. Vol.1:1-14.

Sobek, A.A., W.A. Schuller, J.R. Freeman and R.M. Smith. 1978. Field and Laboratory Methods Applicable to Overburdens and Minesoils. Report EPA-600/2-78-054, U.S. National Technical Information Report PB-280 495.

Stantec Consulting Ltd. 2004. Review of Water Quality Issues in Neutral pH Drainage: Examples and Emerging Priorities for the Mining Industry in Canada. MEND Report 10.1.

Vigneault, B., Y.T.J. Kwong and L. Warren. 2008. The Role of Biofilm on the Long-term Performance of a Shallow Water Cover to Limit Reactive Tailings Oxidation and Metal Mobilization. In: Proceedings of 15th Annual British Columbia - MEND ML/ARD Workshop, The Management of Tailings and Tailings Impoundments. Vancouver, British Columbia, December 3-4.

## 4.0 MAIN STEPS AND STAGES OF A PREDICTION PROGRAM

### *Some Important Points in this Chapter*

*There are three main steps for predicting drainage chemistry. First, the general properties of the project and site should be reviewed. Second, any existing drainage chemistry should be measured and monitored, then potential future drainage chemistry predicted. Third, predictions made from the previous steps should be periodically checked and updated, with any significant information gaps identified and highlighted. The third step should be conducted repeatedly through all stages of a project.*

While the information and methods may vary depending on site specific requirements, drainage chemistry prediction should consist of the following three main steps.

1. Review the general properties of the project and the site.
2. Measure the existing drainage chemistry, if any, and predict potential future drainage chemistry.
3. Verify the predicted compositions of the materials and drainage chemistry made in Steps 1 and 2 and conduct follow-up studies to address information gaps.

A more detailed description of each step follows.

### 4.1 Step 1 – Review General Properties of the Project and Site

Developing an understanding of general properties of the project and site should be the first task in any drainage chemistry prediction program. The information will be used to:

- identify potential objectives and concerns;
- select samples, analyses and test work, and interpret drainage chemistry results for each waste material and project component and the project as a whole; and
- create conceptual models of key properties and processes of the project.

General properties of the project and site that should be reviewed prior to predicting drainage chemistry typically include:

- geography;
- baseline conditions;
- climate;
- hydrology and hydrogeology;
- regulatory, community and corporate needs for environmental protection and reclamation;
- geology; and
- project history, plans and components.

Paralleling the requirement for more detailed and accurate information on drainage chemistry, more detailed and accurate site and project information may be required as the project develops.

## 4.2 Step 2 – Measure Existing Drainage Chemistry, If any, and Predict Potential Future Drainage Chemistry

The main questions that should be asked regarding the characteristics of the drainage chemistry are whether the drainage will meet water quality objectives, if the drainage will not meet water quality objectives, what parameters will not be met and how large will their exceedance be, what will be the spatial extent of the problem and when will the exceedance(s) occur?

The answer to these questions will depend on the:

- initial composition of the excavated and exposed materials;
- changes in physical and geochemical properties due to weathering;
- drainage conditions (hydrogeology and hydrology);
- transportation of contaminants; and
- the sensitivity of valued components of the environment and the drainage chemistry required to have a significant environmental impact.

Drainage chemistry prediction should be made for each different combination of geologic material, form(s) of exposure (e.g. waste rock, tailings and mine walls) and post-mining condition(s) (e.g. deposited aerially or underwater). Prediction of drainage chemistry is typically done first for individual samples, then for whole geologic strata or waste units and finally for project components and the project as a whole. If there is, or potentially will be, a drainage chemistry problem, the existing prediction information is then used to decide what additional prediction is required and how to mitigate and/or modify excavation and materials handling to prevent significant environmental impacts (see Chapter 2).

While Step 2 comprises much of any prediction program, practitioners are cautioned not to ignore the other steps. Step 1 is important in selecting samples and test work and interpreting the results. Step 3 will be required to address gaps and uncertainty in the initial prediction. An important objective of Step 2 is to identify gaps and uncertainty and indicate what follow-up work is required (e.g. operational material characterization), which parameters should be measured and the sampling procedure and frequency.

### 4.2.1 Properties and Processes Potentially Affecting Drainage Chemistry

The prediction of drainage chemistry from sulphidic geologic materials may require site specific measurement or estimation of the following properties and processes.

- The total solid phase concentration of different elements and the potential acid generation potential and acid neutralization potential.
- The aqueous concentrations of soluble elements, acidity and alkalinity and the resulting pore water pH.
- The minerals in which potentially deleterious elements and potential acidity and neutralization occur. The extent to which potentially deleterious elements and potential acidity and neutralization occur in relatively reactive minerals. For example, will acid generation and elemental release result almost entirely from sulphide oxidation or will there be significant contributions from other sources?

- The extent to which relatively reactive minerals containing potentially deleterious elements and potential acidity and neutralization will be exposed by excavation, processing, deposition and weathering.
- Changes in composition due to processing (e.g. removal of concentrate and addition of lime), deposition (e.g. segregation of spigotted tailings) or some other process.
- Physical and geochemical conditions (e.g. drainage features, degree of aeration and drainage pH and alkalinity) under which weathering and leaching will occur.
- The weathering reactions required to release potentially deleterious elements and potential acidity and neutralization in relatively reactive minerals into a soluble form.
- Rates of mineral weathering and the leaching and loadings of soluble constituents under the predicted physical, geochemical and drainage conditions.
- The length of time it will take for net acidic conditions and/or changes in other important hydrological, weathering, and leaching properties and processes to take place.
- The initial composition of the leachate and the location of leaching and discharge.
- The solubility limit (e.g. maximum carrying capacity) of the predicted drainage chemistry for potentially deleterious elements.
- Differences between the test conditions and materials used in prediction and the materials and weathering conditions present at the project site.
- Geochemical criteria that can be used to separate potentially net acid generating<sup>7</sup> materials from net neutral materials.
- Geochemical criteria that can be used to separate materials predicted to potentially produce problematic near-neutral pH or alkaline drainage chemistry from materials predicted to potentially produce benign drainage.
- Movement of eroded particles by air (e.g. dust) or water (e.g. sediment).

Important questions for existing projects are whether project components are already experiencing acidic weathering conditions, produce deleterious drainage or contain significant concentrations of deleterious elements in a soluble form.

#### 4.2.2 Materials to Analyze and Test

Prediction data may be obtained from a great variety of materials. The availability of representative materials to analyze will depend on the status and type of the operation. Prior to project development, analyses and tests may be conducted on exploration drill core, weathered surface materials and materials from surface excavations or adits. During and after project development, data may be collected from analyses and tests conducted on pre-blast drill cuttings and the resulting wastes and mine walls. Analysis may also be conducted on the resulting drainage and the associated gas phase (e.g. temperature and chemical composition).

Difficulty in obtaining representative samples for some wastes and mine workings may result in information gaps.

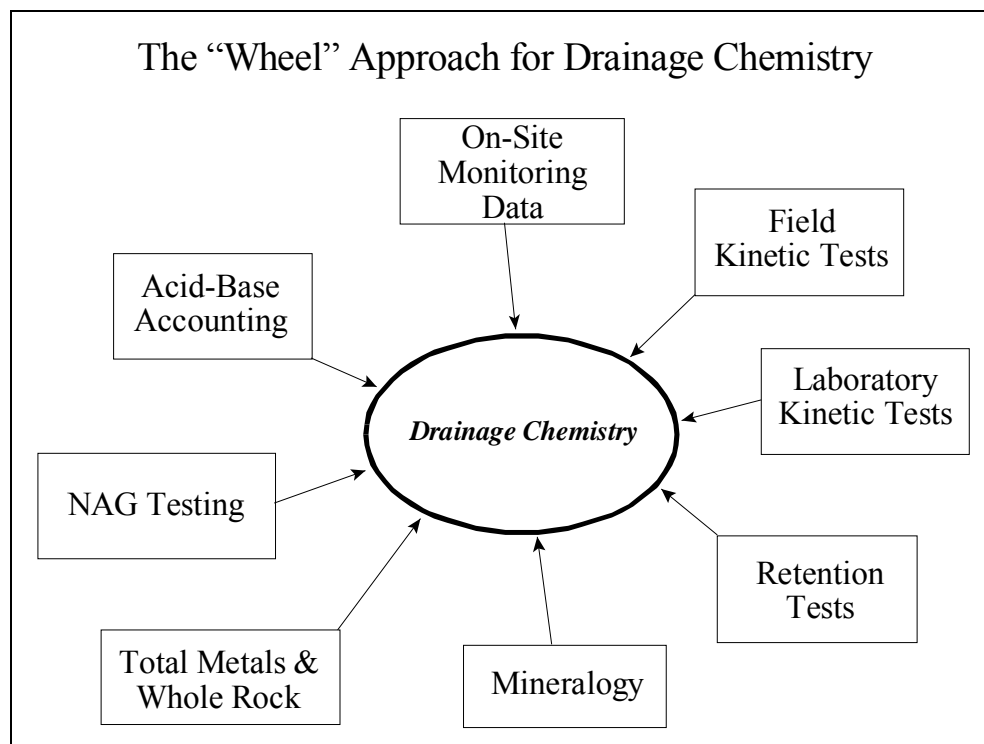
---

<sup>7</sup> The term potentially net acid generating is used to indicate the result if the material is allowed to weather aerobically, although net acid generation may be averted by measures such as flooding.

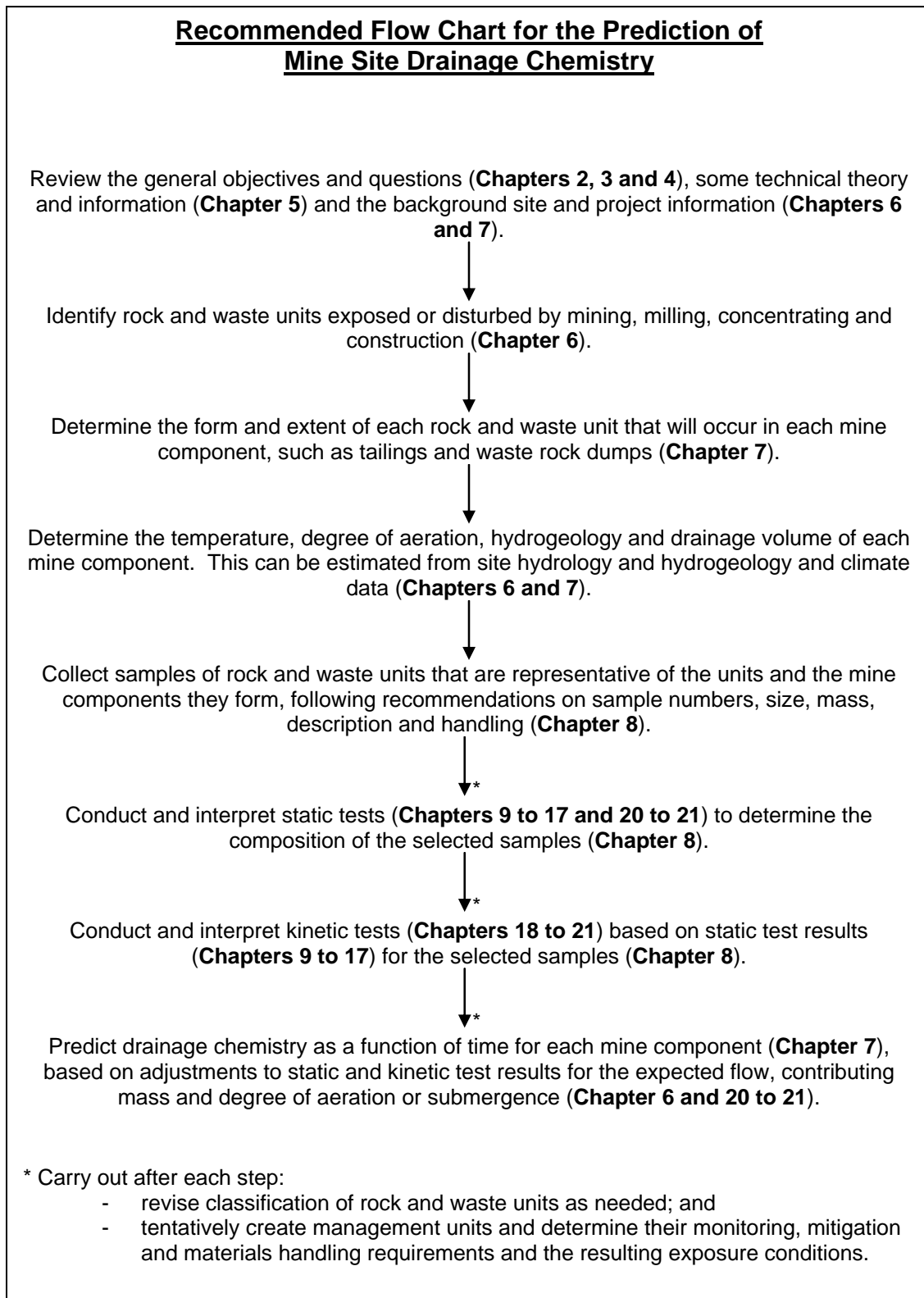
### 4.2.3 Analyses and Test Procedures

Prediction data is derived from one time analyses of the present composition (e.g. static laboratory tests), repetitive measures of changes in composition over time (e.g. kinetic laboratory tests and on-site field trials), calculations and models (e.g. mineral equilibrium solubility models) and previous experience (Figures 4.1 and 4.2). In some cases, standard calculations are used to convert the measurement or measurements into common units of interest (e.g. % sulphide-S is multiplied by 31.25 to convert it into kg CaCO<sub>3</sub> equivalent/tonne acid potential).

As with all aspects of drainage chemistry prediction, the physical, hydrogeologic, hydrological and geochemical conditions that control weathering and leaching must be considered in the selection of which tests to conduct and the interpretation of their results. An important consideration in the interpretation of test results is the difference between laboratory or small-scale test conditions and the actual materials at the site with respect to key parameters such as the rate of air entry, temperature, particle size and the ratio of solid to water.



**Figure 4.1 Drainage chemistry prediction should be based on results from a variety of tests (Morin and Hutt, 1999).**

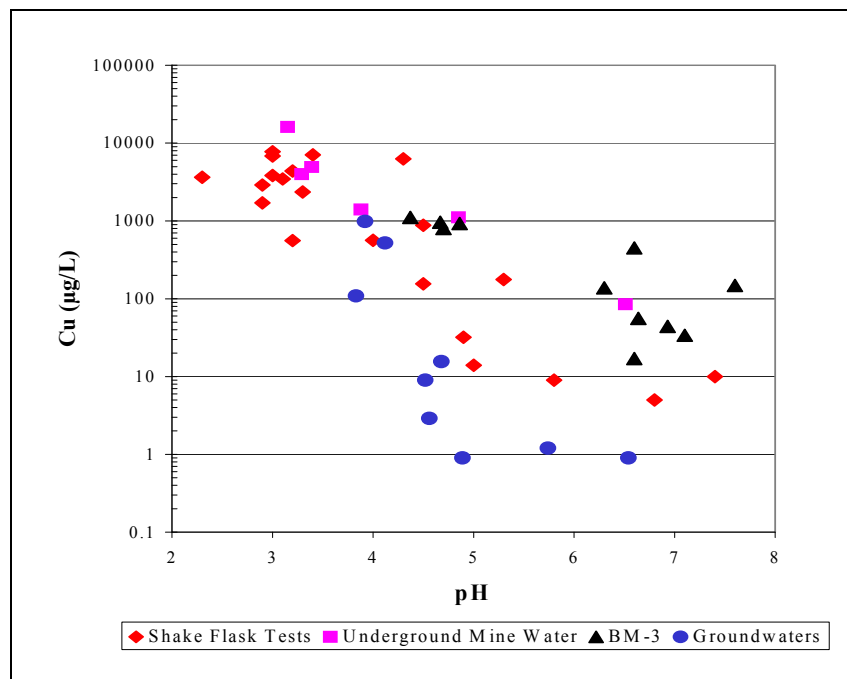


**Figure 4.2 Recommended flowchart for the prediction of drainage chemistry.**

Some tests have very specific procedures and data interpretation requirements and it is very important to follow closely the recommended methodology (e.g. NP measurements, Chapter 13). Aspects of other analytical procedures (e.g. analysis of the concentration of soluble or dissolvable constituents) or tests (e.g. trickle leach tests) should be modified to match site conditions (e.g. composition and volume of leachate). Different procedures for measuring the same or similar properties may give different results. It is therefore important to identify the analysis procedure as well as the property when reporting or discussing test results.

*Some tests have very specific procedures and data interpretation requirements and it is very important to follow closely the recommended methodology.*

Information should be derived from a variety of sources and tests. There is no single piece of evidence or test that can provide a reliable prediction of drainage chemistry on its own (Figures 4.1 to 4.3).



**Figure 4.3 Evidence from several sources can provide a more reliable prediction of the drainage chemistry (from Stephen Day of SRK).**

#### 4.2.4 Measures of the Present Composition of Materials at the Site (Static Tests)

Depending on site specific conditions, the following static tests and calculations may be used for drainage chemistry prediction:

- whole-rock or near total element analysis by XRF or ICP after fusion or strong acid digestion;



- soluble constituent (selective dissolution) analyses:
  - total mass soluble if leached or flooded (especially for weathered and oxidized materials);
- pH analyses:
  - surface rinse pH for weathered material, or
  - crushed sample pH (paste pH) for unweathered material;
- sulphur species and acid potential analyses and calculations, in some cases including sulphide, acid leachable sulphate, acid insoluble sulphate and total sulphur and forms of sulphide-sulphur;
- neutralization potential analysis and calculation:
  - Bulk Neutralization Potential;
    - Sobek neutralization potential, or
    - Modified neutralization potential.
  - carbonate content and calculation of carbonate neutralization potential, including detection of iron and manganese carbonates;
- Acid Base Accounting statistics derived from the above:
  - Neutralization Potential Ratio (NPR) calculation, and
  - Net Neutralization Potential (NNP) calculation.
- mineralogy and other geologic properties:
  - visual examination,
  - petrographic scan,
  - XRD scan, and
  - other procedures such as SEM/EDS, microprobe or laser ablation may be added to answer specific questions that cannot be answered by the generic procedures listed above;
- physical analyses (especially for kinetic tests):
  - particle size analyses, and
  - surface area; and
- NAG procedures.

Static test results are generally used in conjunction with data from other static and kinetic tests (see Figures 4.1 and 4.2, and Chapter 9),

*Static test results are generally used in conjunction with data from other static and kinetic tests, solubility modeling, information on weathering conditions and other inputs to drainage chemistry and previous experience at other similar mine sites.*

information on weathering conditions (Chapters 5 and 6) and other inputs to drainage chemistry and previous experience at other similar mine sites. For example, soluble concentration of different chemical species may be used

along with the volume and chemistry of the flood water and solubility modeling to predict trace element dissolution and the resulting drainage chemistry if geologic materials are flooded. The acid and neutralizing potential, along with the mineralogy and humidity cell reaction rates, may be used to predict approximate times to the onset of acidic drainage under aerobic weathering conditions. An important part of the interpretation of laboratory kinetic test results is evaluating the impact of the differences compared to field conditions. Information from static tests is required to select samples for kinetic testing that are representative of the conditions of concern and to assess the kinetic test results.

### 4.2.5 Measures of Reaction Rates and Changes in Drainage Chemistry (Kinetic Data)

Depending on site specific conditions, the following static tests and calculations may be used for drainage chemistry prediction:

- rates of sulphide oxidation and the depletion rates of neutralizing minerals (humidity cells);
- weathering and drainage chemistry (trickle leach columns, on-site test pads and wall-washing stations); and
- weathering, drainage chemistry and loadings from any existing dumps, impoundments and mine workings (monitoring of entire or parts of project components).

An important consideration in the selection of kinetic test work is the parameter to be measured or predicted. Measurements of the rates of sulphide oxidation and the depletion of neutralizing minerals require very different test conditions from kinetic tests used to measure solubility constraints and to predict drainage chemistry.

## 4.3 Step 3 – Verify the Predicted Compositions of the Materials and Drainage Chemistry and Address Significant Information Gaps

Step 3 consists of the tasks needed to verify, refine and fill gaps in the predictions of material composition, weathering rates and conditions and drainage chemistry made in Step 2. Verification typically includes operational material characterization and the follow-up monitoring of weathering and drainage. Additional study requirements will depend on the site, project, previous sampling and analysis, existing information, deviations from the predicted performance and environmental protection needs.

### 4.3.1 Operational Material Characterization

The purposes of operational material characterization include:

- verify, refine and address gaps in the characterization of materials excavated, exposed or otherwise disturbed by the project;
- segregate materials requiring different handling, disposal or mitigation; and
- create an inventory of the composition of materials excavated, exposed and/or otherwise disturbed by the project.

It would be important to check pre-development predictions of drainage chemistry properties, such as mineralogy and ABA characteristics during development and production for the same reason that mines conduct detailed sampling and analysis during mining to check pre-mine predictions of ore grades. Unlike ore analysis, where the concern is with the average and whole sample composition, drainage chemistry depends on the range in composition, and composition of different size fractions (e.g. < 2 mm fraction of waste rock or tailings slimes and sand that segregate during deposition). The sampling and analysis requirements for different materials during different stages of a project are discussed in more detail starting in Chapters 7, 8 and 9.

### 4.3.2 Monitoring Weathering, Drainage Conditions, Drainage Chemistry and Residual Effects

Previously, monitoring was primarily to detect environmental impact and measure permit compliance. In an effective drainage chemistry prediction program, monitoring of weathering, drainage conditions and drainage chemistry is also conducted to:

- verify, refine and address gaps in the predictions of future drainage chemistry and contaminant loadings;
- inform corrective actions, and
- provide early warning of potential problems allowing proactive resolution, adaptive management and the timely implementation of contingency plans.

Monitoring should include measurement of geochemical (e.g. pH and redox), hydrologic (e.g. flow rates), hydrogeological (e.g. rate of discharge and height of the water table) and ecological (e.g. aquatic plant invasion) properties and processes that cause mineral instability and changes in drainage chemistry and contaminant loadings. For example, the analysis of samples from long term monitoring sites set up on the surface of project components can be used to measure mineral depletion, changes in weathering conditions and the onset of acidic drainage chemistry. The monitoring of individual seeps is used to detect changes in drainage chemistry that may be masked in the composite drainage from a large project component (e.g. Figure 3.3). Monitoring of properties such as heat and rate of oxygen depletion can be used to predict the rate of sulphide oxidation and locate regions of the waste rock dump with the highest rates.

Another objective for monitoring is the mapping of residual contaminant concentrations that are a potential concern in site components, such as vegetation, for those who may drink the water or digest the flora and fauna. In addition to sulphidic materials and materials impacted by sulphidic drainage chemistry, mapping should also indicate materials potentially contaminated by air (e.g. dust) and water borne (e.g. sediment) sulphidic particles.

It is recommended that monitoring occur until there is no longer the potential for deleterious drainage chemistry. Since processes such as lag time to acid drainage production or mine wall collapse may take many years to occur, long term monitoring will usually be required.

### 4.3.3 Follow-Up Studies to Address Information Gaps

Not all prediction questions can be fully answered in the initial prediction of drainage chemistry or prior to project development. Most projects need operational, closure and post-closure studies to verify and refine predictions, fill information gaps, complete closure plans, reduce risks, estimate the liability and address unforeseen concerns. For example, for most sites it is valuable to set up on-site field test pads to improve the understanding of site and material specific weathering and the relationship between previous laboratory measurements and actual field weathering rates.

Common reasons for conducting follow-up studies discussed in Section 3.13 include:

- the relatively short term nature of pre-development kinetic tests;

- differences between materials and conditions in pre-development laboratory tests and the actual materials and weathering conditions at the site;
- changes to the project plans alter the materials or weathering conditions;
- uncertainty about future site conditions such as the composition of waste rock fines, ultimate pit walls or the height of the water table; and
- a lack of samples from the perimeter of the project (e.g. waste rock far from the ore zone) prior to development.

There is often great value in continuing to run laboratory kinetic tests during subsequent stages of project development and setting up field test pads and study sites on project components to improve the understanding of weathering. Properties that are difficult to predict prior to project development include the composition of waste rock fines and materials segregated during tailings deposition and changes during ore processing. Additional weathering studies may be needed once the composition of these materials and the location of final walls are determined. Changes to the mine plan will likely require additional prediction studies and changes in the operational material characterization and monitoring of weathering and drainage (Section 3.14).

#### 4.4 Prediction During Different Stages of Project Development

The stage of the project, along with gaps in the existing prediction data and proposed new developments, will determine the information required, when it will be required and potential sources of test materials and test sites. From the perspective of prediction, the main stages of the project include:

- exploration;
- feasibility studies and project planning;
- construction;
- mining and processing;
- closure; and
- post-closure.

Although the materials and methods may change depending on the stage of project development, it is important that prediction be conducted throughout the life of a project with closure planning starting at the mine planning and mine development stage. One objective in conducting

*It is important that prediction be conducted throughout the life of a project. This includes all major stages of a project: exploration, mine planning, construction, mining and processing, closure, and post-closure.*

prediction at each stage is to demonstrate that the project has the necessary facilities, plans, understanding, site capacity, resources and intent to sustain the mitigation needed for environmental protection (Section 3.5). This includes identification and contingency plans to deal with

significant gaps in the prediction of drainage chemistry. Another common consideration at every stage of the project is that sampling, analysis, test work and the interpretation of prediction results should be completed in time to meet the proactive, decision making needs of a project.

#### 4.4.1 Minimum Mass of Material Requiring Prediction

Prediction is required if the material is capable of producing a significant environmental impact. The lowest or minimum mass capable of producing a significant impact may decrease with:

- increases in sulphide and trace element content;
- increases in particle surface area (e.g. smaller particle size);
- increases in drainage volume;
- increases in mineral reactivity and contaminant solubility (e.g. acidic weathering conditions and drainage pH); and
- reductions in dilution and/or attenuation prior to a sensitive receptor.

For example, the surface area and drainage inputs of drill cores are typically too low to be a concern.

For exploration, the British Columbia Ministry of Energy, Mines and Petroleum Resources typically use a criterion of 1,000 tonnes of sulphidic material before any prediction is required. A small sized pile (i.e. less than 1,000 tonnes) typically has limited drainage inputs and a low particle surface area. Criteria of this sort should not substitute for common sense. The minimum tonnage for conducting prediction may need to be reduced where:

- the sulphidic material is highly reactive;
- the sulphidic material has high concentrations of soluble contaminants;
- there is significant drainage through the pile; or
- there is very little attenuation or dilution between the discharge source and the sensitive environment.

Sensitivity analyses can be conducted to predict the minimum mass capable of producing a significant environmental impact using project site data and/or assumptions regarding the site and project conditions. A simple example of a sensitivity analysis showing the required watershed area for dilution by background drainage, to prevent exceedance of downstream water quality objectives by hypothetical dump drainage, is provided in Table 4.1. The calculations in Table 4.1 assume dilution is permissible, a 3 m dump height is in place and no geochemical interactions occur, such as precipitation/dissolution or adsorption/desorption.

**Table 4.1 Required area for dilution to prevent hypothetical drainage from small rock dumps from exceeding downstream water quality objectives.**

		Neutral pH with Zinc	Acidic pH with Copper
Downstream Objective	mg/L	0.03	0.004
Background Concentration	mg/L	0.005	0.001
Dump Drainage Concentration	mg/L	2	20
Dump Mass	tonnes	1000	100
Bulk Density	t/m <sup>3</sup>	1.5	1.5
Dump Volume	m <sup>3</sup>	670	67
Dump Height	m	3	3
Dump Area	m <sup>2</sup>	220	22
Required Area for Dilution	m <sup>2</sup>	18,000	150,000
	ha	1.8	15

- Assumptions:
- 1) Flows per unit area from the waste rock dump are the same (same timing, lag, and rate) as from the rest of the watershed.
  - 2) The only source of dump drainage is incident precipitation. Drainage from upstream does not flow through the waste rock pile.
  - 3) The watershed for dilution is the catchment area above the mixing point with the waste rock drainage.
  - 4) There are no geochemical interactions in the receiving environment, such as precipitation/dissolution or adsorption/desorption, that would reduce the contaminant load.

#### 4.4.2 Exploration

Exploration includes a wide range of activities and the prediction requirements depend on the degree of exposure or disturbance of sulphidic geologic material. Exploration activities such as collecting rock chips and soil sampling disturb relatively little sulphidic overburden or bedrock and drainage chemistry prediction is usually not required. Diamond drilling and trenching expose or disturb more sulphidic overburden or bedrock and the drill core and overburden should be placed in locations with relatively little leaching and away from sensitive resources. Drainage chemistry prediction will only be required if the amount of drilling and trenching is extremely large.

Exploration activities that may result in the excavation or movement of large masses of sulphidic bedrock or overburden and where drainage chemistry prediction may be required include:

- excavation of an exploration adit;
- removal of a bulk bedrock sample for processing; and
- construction of large rock cuts for a road or drill pad.

The excavation or movement of sulphidic bedrock or overburden by these activities may rival a small mine.

One reason for conducting prediction testing during advanced exploration is for environmental protection. In addition, starting the prediction of drainage chemistry as soon as possible, assuming that there is adequate knowledge of the deposit and material to test, will increase the time available for a cost-effective, phased prediction program and any time intensive kinetic test work. This will minimize delays during mine development if further data collection is needed to address unacceptable uncertainty regarding some aspect of the future drainage chemistry (Sections 3.13 and 3.20).

*Starting the prediction of drainage chemistry as soon as possible during exploration will increase the time available for a cost-effective, phased prediction program and any time intensive kinetic test work.*

Creation of a data base of prediction materials, methods, results and relevant properties of the project and site should accompany the initiation of drainage chemistry prediction (Section 3.24).

#### 4.4.3 Feasibility Studies and Project Planning

The objectives of prediction during feasibility studies and project planning prior to excavation and processing are to:

- predict the potential future drainage chemistry, determine the magnitude and spatial variability in influential properties and processes, and predict the timing of significant changes; and
- determine what excavation, waste handling, disposal, mitigation, financial resources, monitoring, operational material characterization and supplemental prediction is required.

Prediction during project planning consists of Steps 1 and 2 from Sections 4.1 and 4.2. Typically this requires a:

- review of the general properties of the project and the site; and
- prediction of both the most probable drainage chemistry and the potential for any unacceptable conditions or performance.

Prediction of drainage chemistry should be done for all materials that will be excavated or exposed for construction and during mining. This work should reduce the uncertainty regarding drainage chemistry to a level at which effective impact prevention strategies can be selected and the potential liability determined.

Because of the site specific nature of the problem and large potential environmental impacts and costs, even for conceptual planning and approval, a comprehensive prediction of future drainage chemistry may be required to indicate what, where and when mining, processing, mitigation and closure measures are required to protect the environment.

An important part of pre-mining prediction is indicating what operational material characterization and supplemental prediction studies should be performed. In the development of plans for operational material characterization, thought should be given to the purpose, the time available to obtain results, what parameters are to be measured, materials to be samples and the sampling procedure and frequency of operational material characterization. Materials and

methods may vary depending on whether the purpose is verifying the predicted composition, segregating materials or determining the composition of materials not previously sampled.

Most pre-mining material characterization comes from the sampling and analysis of drill core.

*One potential challenge in pre-mining prediction is the lack of waste rock or tailings with which to predict the difference in composition between drill core and the resulting waste rock fines or tailings fractions.*

One potential challenge in pre-mining prediction is the lack of waste rock or tailings with which to predict the difference in composition between drill core and the resulting waste rock fines or tailings fractions. Prior to mining, there may be limited information on the impact of

blasting on the composition of waste rock fines or processing on the composition of the tailings. Some information on the composition of tailings may be available from metallurgical testing.

Another potential challenge is the lack of drill core data from deeper in, or at the edge of, the deposit. In the past, un-mineralized (less mineralized) material at the edge of the deposit had been assumed to have a negligible sulphide mineral content and therefore little potential for problematic drainage chemistry, when in fact this was not the case (Price and Yeager, 2004).

If it has not already been done, a data base of prediction materials, methods and results and relevant properties of the project and site should be created (Section 3.24).

#### 4.4.4 Construction, Mining and Processing

The objectives of prediction during construction, mining and processing are as follows.

- Verify and refine prediction during project planning and fill gaps.
- Segregate materials requiring different handling, disposal or mitigation.
- Track trends in material composition, weathering and leaching conditions and site drainage chemistry.
- Check what financial resources, monitoring and supplemental prediction is required.
- Create an inventory of the composition of materials excavated, exposed and/or otherwise disturbed by the project.
- Provide early warning of potential problems in excavation, waste handling, disposal, mitigation and operational material characterization, allowing proactive corrective actions and implementation of contingency plans.

Operational characterization of the material composition during construction, mining and processing and monitoring of the weathering and resulting drainage chemistry, is needed to predict the drainage chemistry of each material created, exposed or disturbed by the project (Figure 4.4a). Characterization of material composition becomes far more difficult once materials are buried (e.g. waste rock) or the access to portions of the project is cut-off. Gaps in pre-development predictions that operational material characterization should check, include the composition of:

- geologic materials which were impossible to sample;
- waste rock fines;



- tailings sand and slimes; and
- the composition of the final mine walls.

In addition to materials produced or exposed by mining and processing, operational characterization should be conducted on materials removed or deposited to construct infrastructure such as roads, foundations, dams and any soil and overburden stripped in the first phase of mine construction. Operational characterization is required even if the construction materials are a long distance from the mine. Experience at a number of sites has shown that materials some distance from the mine can produce problematic drainage (Section 3.2 and Figure 4.4b).

Visual evaluation of the geochemical composition has not proven accurate and will not suffice.

*Visual evaluations of the geochemical composition has not proven accurate and will not suffice.*

There have been a number of instances where rock was capable of generating acidic drainage despite no visual sign of sulphide minerals (Price and Yeager, 2004). Detailed laboratory analysis and testing of spatially and geologically representative samples is

required to determine geochemical properties such as the sulphide concentration, predict the drainage chemistry and assess whether the drainage chemistry will have an environmental impact.

As in all phases of prediction, sampling and analysis should occur with sufficient time to review and act on the results that indicate materials are a potential source of problematic drainage chemistry. Ensuring sufficient time to sample, analyze and act on the results will be very important where material characterization is used to segregate materials with different disposal requirements or verify processes such as desulphurization (Section 7.11.9.4). Evaluation criteria should be based on analyses that can be conducted quickly at on-site laboratory facilities. Accountability for the different activities in material characterization and effective communication of the results to all the responsible parties will also be needed to ensure successful handling of materials that are a potential source of problematic drainage chemistry.

Operational monitoring of the weathering and seepage chemistry should start as soon as possible (Figure 4.4c). The geochemical and physical heterogeneity and changing plans for mine components are challenges when monitoring the weathering and seepage from project components. One solution is to construct field test pads in an undisturbed area of the site using well-characterized materials that are representative of the range in composition of the materials of concern. Loadings are as important as concentrations and therefore flow should be monitored, along with drainage chemistry. One target of weathering and seepage monitoring will be wastes that are left exposed for some period of time prior to flooding. Field trials may be set up to monitor the weathering of waste rock fines, tailings sand and slimes and to determine field weathering rates and on-site climatic effects.

Not all prediction questions regarding future weathering and drainage chemistry can be answered prior to mining. Most mines need operational and in some cases post-operational studies to address unknowns with regard to future weathering and drainage chemistry in closure, mining, processing and materials handling plans (Figure 4.4d). The need for additional studies will

depend on gaps in previous material characterization and drainage chemistry prediction and changes in the environmental protection needs. Additional operational material characterization, prediction studies and changes to the monitoring of weathering and drainage may also be needed to address changes to mine plans (Section 3.14) and management issues that arise from deviations from the expected composition, size and location of mine workings and waste materials or the timing of activities such as mine closure.

#### 4.4.5 Closure Planning

The first prediction of post-closure drainage chemistry should be conducted during initial mine planning and the first closure plan should be included in the first mine plan. Revised predictions of post-closure drainage chemistry should occur at regular intervals (e.g. every five years) and whenever there are significant changes to site or project conditions (e.g. changes in drainage chemistry or mine expansion).

*The first prediction of post-closure drainage chemistry should be conducted during initial mine planning and the first closure plan should be included in the first mine plan.*

It is important to start addressing outstanding prediction questions in the closure plan early in the mine life so the mine can use its operating resources, facilities, equipment and personnel to conduct long term laboratory studies, set-up field studies and act on the results. Reduced facilities, equipment, resources and personnel after closure will likely increase the costs of monitoring and studies. Starting to address outstanding prediction questions in the closure plan, early in the mining process, will also provide more time to evaluate different solutions and implement any changes to the mitigation plan.

Mine closure may be a difficult time to conduct prediction work and collect data if budgets are cut, facilities are dismantled, workers worry about their own and their families' future, most of the staff departs, and equipment is removed. The imminent departure of key staff and equipment may create tight timelines for the proposed prediction work and its review. Corporate memory loss regarding important aspects of the project and the site may occur long before closure due to staff transfers. Without adequate data base management, staff departure may result in the loss of knowledge of previous prediction activities, what information exists, how it was collected and where it is stored (Section 3.24).



**Figure 4.4a** Sampling and analysis of drill chips is used to characterize sulphidic materials mined at the Ekati Mine.



**Figure 4.4b** Characterization of rock quarried next to the tailings dam at Kemess South, a considerable distance from the mine, indicated it was potentially net acidic and therefore unsuitable for dam construction (photo from Harold Bent, Northgate Minerals Ltd.).





**Figure 4.4c** During mining, prediction also includes monitoring weathering prior to mitigation (in this case flooding) and the volume and chemistry of the associated drainage (photo of Eskay Creek Mine in northwest British Columbia).



**Figure 4.4d** During mining, the Huckleberry Mine continually refined its prediction of water quality for the portions of the East Zone pit and plant site that will not be flooded.

Another important consideration in encouraging an early start to operational studies closure planning is the reduced access after portions of the mine close. This is especially important for open pits and underground mines where access to mine workings and backfill may become unsafe soon after the mining of those areas ceases (Price, 2005).

In addition to prediction analyses and tests, more detailed and accurate site and project information may be required for the prediction of drainage chemistry as the project develops.

#### 4.4.6 After Mine Closure

The objectives of prediction after mine closure are to:

- verify and refine previous predictions and fill gaps;
- track trends in weathering and drainage conditions and site drainage chemistry;
- determine what financial resources, monitoring and supplemental prediction is required;
- maintain an inventory of the composition of materials excavated, exposed and/or otherwise disturbed by the project; and
- provide early warning of potential problems, allowing proactive corrective actions and implementation of contingency plans.

After a mine closes, many properties and processes controlling weathering and drainage conditions are in flux and there are a number of possible scenarios regarding future drainage chemistry (Section 3.8). Post-closure prediction should continue for as long as there is a need for the proactive detection and resolution of potential drainage chemistry problems (Section 3.10).

Closed mines may conduct laboratory and field studies and monitoring to address unknowns regarding future weathering and drainage chemistry and address deviations from the predicted drainage chemistry. Monitoring should track changes in weathering and drainage properties and processes that are in flux and whose future impact on drainage chemistry may be uncertain (Figure 4.5 and Section 3.13).

Changes to the landscape, drainage inputs and flow paths due to mining may result in

*Changes to the landscape, drainage inputs and flow paths due to mining may result in considerable uncertainty about post-closure drainage conditions.*

considerable uncertainty about post-closure drainage conditions and the rate and location of drainage discharge. Construction of raised tailings impoundments and groundwater rebound as mine workings flood after mine closure may raise the height of the water table and increase sub-surface

drainage inputs and leaching. Conversely, reduced drainage inputs as a result of cessation of tailings deposition, maintained diversion ditches and unflooded mine workings may lower the water table and increase sub-surface oxygen entry. Underground workings and open pits may have the opposite effect.



**Figure 4.5** After a mine closes, operational monitoring of weathering and seepage may continue to track changes in properties and processes that are in flux (photo of Pinchi Lake Mine in northwest British Columbia from Bruce Donald of TeckCominco Ltd.).

Post-closure monitoring may also be needed for tracking potential drainage chemistry changes due to the subsidence of mine workings, site reclamation, climate changes and off-site development. Land development, logging and beaver activity upstream of the site may change the location of drainage inputs and increase the magnitude of runoff and drought events. Natural and anthropogenic climate change may impact a wide range of drainage and weathering processes. The monitoring of reclaimed areas may include assessing the impacts of the uptake of contaminants by vegetation and wildlife using the site on wildlife populations, and resource use by local residents.

Post-closure prediction should continue for as long as there is significant uncertainty regarding weathering and leaching and a potential need for the proactive detection and resolution of drainage chemistry problems (Section 3.10). An important part of this is providing sufficient resources to store previously collected site information and to regularly update and review new study results and monitoring records.

#### 4.4.7 Omissions and Errors in Previous Stages of the Project

Comprehensive, cradle to grave predictions of drainage chemistry and adoption of the best prediction practices are relatively new phenomena. As a result, older mines generally lack detailed material characterization and may have gaps in the prediction of drainage chemistry that need to be addressed.

*Older mines generally lack detailed material characterization and may have gaps in the prediction of drainage chemistry that need to be addressed.*

Common omissions at older mines include a failure to:

- record the masses of different geologic types of tailings and waste rock types and where they were placed (e.g. within impoundments, dumps and other mine components);
- conduct operational sampling and analysis of the geochemical composition of different fractions;
- conduct long term kinetic tests on well-characterized samples that are representative of the materials of concern; and
- provide the necessary documentation of methods (e.g. fizz rating for Sobek-NP analyses) for the interpretation of analysis and test results.

In some instances, it may not be possible to collect missing information at a later stage of the project and the resulting uncertainty increases the difficulty in predicting future seepage chemistry. For example, geochemical studies during later phases of operations may characterize the waste rock on dump surfaces and mine walls. However, uncertainty would remain on the composition of the finer size fraction of the waste rock and on the distribution of waste rock types deeper within large, heterogeneous dumps that were built in several lifts. Sampling of existing mine components is discussed in Chapter 8.

Other common omissions that may be difficult to rectify are a lack of long term field tests on well-characterized representative materials or proper documentation of the test methods (e.g. fizz rating for Sobek-NP analyses) that can be used in the interpretation of laboratory results.

#### 4.5 References

Morin, K.A. and N.M. Hutt. 1999. Prediction of Minesite - Drainage Chemistry Using the “Wheel” Approach. MDAG Internet Case Study #15, [www.mdag.com/case\\_studies/cs11-99.html](http://www.mdag.com/case_studies/cs11-99.html).

Price, W.A. 2005. Case Studies of ML/ARD Assessment and Mitigation: Snip Gold Mine. MEND Report 9.1c.

Price, W.A. and D. Yeager. 2004. Case Studies of ML/ARD Assessment and Mitigation at the Johnny Mountain Gold Mine. MEND Report 9.1a.





## 5.0 PARAMETERS AND PROCESSES CONTROLLING DRAINAGE CHEMISTRY

### *Some Important Points in this Chapter*

*There are a large number of parameters and processes that affect site specific drainage chemistry from sulphidic geologic materials. This chapter discusses the more important ones from a geochemical perspective.*

A large number of parameters and processes affect the drainage chemistry from sulphidic geologic materials. They include environmental variables such as temperature and precipitation, and site specific parameters such as location of excavations and mining methods. An understanding of these factors and processes, and their potential impact on drainage chemistry is necessary in designing a prediction program and interpreting the results.

### 5.1 Introduction

The primary processes causing problematic drainage chemistry from sulphidic geologic materials

*Although impacts from sulphide oxidation and dissolution most commonly result from acidic drainage and metal leaching, environmental impacts may also occur from drainage with a near neutral or basic pH. It is important to note that constituents of non-sulphide minerals may also be a drainage chemistry concern.*

are oxidation of the sulphide minerals and the subsequent dissolution and transport of potentially deleterious elements, such as Cu and Zn by migrating drainage. Oxidation of sulphide minerals results from exposure to (1) moisture and (2) oxygen or some other oxidizing agent such as ferric iron. Oxidation transforms the relatively insoluble chemical species

in sulphide minerals into more soluble and mobile species, such as ionic copper and zinc. Depending on the concentration and the associated chemical conditions, a portion of the dissolved ions may precipitate as secondary minerals, such as sulphates, carbonates and hydroxides. For example, oxidation changes the copper, iron and sulphur in the sulphide mineral chalcopyrite ( $\text{CuFeS}_2$ ) into ions (e.g.  $\text{Cu}^{2+}$ ,  $\text{Fe}^{3+}$  and  $\text{SO}_4^{2-}$ ) and secondary minerals, such as copper carbonate (e.g. malachite  $\text{Cu}_2\text{CO}_3(\text{OH})_2$ ) and iron hydroxide ( $\text{Fe}(\text{OH})_3$ ).

In addition to being a reactant, water dissolves and carries the chemical species released by sulphide oxidation. Dissolved elements can then be transported into surface and ground water bodies where they may come in contact with sensitive receptors.

In addition to releasing potentially harmful elements, sulphide oxidation can also produce acidity, which if not neutralized will lower the pH. Increased acidity and a lower pH increase the solubility of many elements of concern (e.g. Cu) and can increase the rates of sulphide oxidation and other weathering reactions, producing even more solutes.

It is also important to note that it is not just the chemical components of sulphide minerals and their weathering products that are a drainage chemistry concern. Other minerals in sulphidic rock, especially minerals that are relatively soluble under various pH conditions (e.g. gypsum), may also contribute to drainage chemistry problems. Examples of potential contaminants in non-sulphide minerals include Fe and Mn from carbonates (e.g. the dissolution of siderite is greatly increased by a decrease in pH) and Al and Fe from silicates.

### 5.1.1 Geologic Materials

The two main types of geologic materials are bedrock and non-lithified or particulate materials.

*The two main types of geologic materials are bedrock and non-lithified or particulate materials.*

Differences in the parent material and the mode of formation of bedrock and non-lithified materials results in differing physical, chemical and weathering characteristics, whereas differences in the physical and chemical composition and in the susceptibility to

weathering of geologic materials leads to variations in drainage chemistry.

Bedrock is a general term used for solid masses of rock produced by igneous, metamorphic and sedimentary processes. It is largely inorganic but may also contain organic materials such as coal. Bedrock may be exposed at the surface but is more commonly buried beneath non-lithified materials.

Non-lithified materials or particulate matter are surficial and consist of inorganic and organic particles produced by one or a combination of the following processes: weathering; biological accumulation; anthropogenic and volcanic activity; deposition by water, wind, ice or gravity; chemical precipitation from solution; and secretion by organisms. Other terms for non-lithified materials include unconsolidated materials, soil, earth and overburden. Anthropogenic non-lithified surficial materials include waste rock and tailings.

At metal mines, the term overburden refers to naturally non-lithified materials. At coal mines, overburden is also used to describe bedrock on top of coal seams. The term soil refers to the upper portion of non-lithified materials that has been altered due to plant growth, climate effects, drainage, macro and microorganism activity or topographical position. The term is also used for material that either serves or has the potential to serve as a medium for the growth of terrestrial or wetland plants.

The main constituents of inorganic matter in geologic materials are minerals. Minerals are inorganic and have a characteristic chemical composition, crystal form, physical properties and an orderly internal structure. Less commonly, some inorganic matter in geologic material may be amorphous, lacking detectable crystal structure or order.

Most inorganic geologic materials contain more than one, and often many different, types of minerals. Minerals are classified according to their chemical composition and structure. In addition to the sulphide minerals, other important groups of minerals include carbonates, aluminosilicates and silicates. The common constituents of carbonate minerals are carbon and oxygen. Many carbonate minerals are relatively soluble under acid conditions and are an important source of alkalinity. The common constituents of aluminosilicate minerals are silica,

aluminum and oxygen; silicates are dominated by silica and oxygen. Phyllosilicates are a subgroup of silicate and aluminosilicate minerals with a layered structure and include the minerals biotite, muscovite, smectite and kaolinite.

Minerals are also classified according to when they were formed. In this Manual, primary minerals refer to those that were created at the time the rock was formed and include minerals formed by igneous, hydrothermal or metamorphic processes. Secondary minerals are minerals formed at or near the surface by alteration, dissolution or precipitation, usually at the expense of primary minerals. There is also a distinction between ore minerals, which are of potential economic value, and gangue minerals which are not.

*In this Manual, primary minerals refer to those that were created at the time the rock was formed.*

minerals refer to those that were created at the time the rock was formed and include minerals formed by igneous, hydrothermal or metamorphic processes. Secondary minerals are minerals formed at or near the surface by alteration, dissolution or precipitation, usually

Amorphous inorganic materials are often produced by weathering. Two of the most common examples are coatings and flocs of iron and aluminum oxyhydroxide. Lime treatment of acidic drainage also produces amorphous iron oxyhydroxide flocs.

Organic geologic materials include rock types such as coal and non-lithified surficial materials such as peat. Organic matter may also be present in largely inorganic geologic materials such as mudstone.

The behaviour of bedrock and non-lithified surficial materials depends on the:

- particle size and structure of the non-lithified material;
- grain size and fabric of the lithified material; and
- type, concentration, surface area and elemental composition and speciation of minerals, amorphous inorganic matter and organic matter.

The crystals or multi-crystal fragments within bedrock or a particle are called grains. Grains may be described by their size and mineralogy. Examples of grains include the sand sized mineral quartz in a sandstone bedrock or a particle of sandstone rock.

Particles refer to separate fragments in non-lithified materials. The dimension of particles can be measured by sieving, settling velocities and image analysis. Particle size categories include the various types of coarse fragments (> 2 mm), such as boulders, stones and gravel, and the different soil sizes (< 2 mm), such as sand (62.5  $\mu\text{m}$  - 2 mm), silt (2  $\mu\text{m}$  - 62.5  $\mu\text{m}$ ) and clay (< 2  $\mu\text{m}$ ). Nanoparticles and colloids are even smaller.

In this document, the texture of a rock refers to the relative proportions of different sized grains within bedrock or a particle. The fabric refers to the spatial and geometrical configuration of all the components within bedrock or a particle including texture, structure and preferred orientation. The structure of bedrock or a particle refers to the grain-size distribution, general disposition, attitude, arrangement or relative positions of different rock types and fabrics, including bedding, stratification, laminations, faults, fractures and folds.

Similar to rock descriptions, the texture of particulate matter refers to the relative proportions of different sized particles. Examples of materials with different textures include the boulder to

clay particles in waste rock and till, and the silt and sand sized particles in metal mine tailings. The fabric and structure of non-lithified materials refers to the size distribution and spatial arrangement of particles and voids, including bedding, stratification, aggregation and bulk density. Fabric usually refers to an individual layer or section, while structure can refer to more than one layer or section or a whole project component.

Element species refers to a chemical entity such as an ion, atom or molecule. Speciation refers to the chemical form in which an element is present or the process whereby various forms of an element become differentiated into ions.

### 5.1.2 Exposure of Sulphidic Geologic Materials

Oxidation, dissolution and other weathering reactions that contribute to drainage chemistry are naturally occurring reactions that result when sulphidic bedrock and non-lithified materials are exposed to air and water (Blanchard, 1968; Lett et al., 1996). Drainage from oxidizing outcrops of sulphide bearing rock (i.e. gossans) often has elevated sulphate, rust coloured iron staining and decreased pH values. Although locally significant and in some instances extensive, the extent of sulphide oxidation in bedrock outcrops is often limited by the relatively shallow depth that oxidation penetrates beneath the surface and the slow rate of exposure of the surface area of the sulphide rock by natural processes.

*Oxidation, dissolution and other weathering reactions that contribute to drainage chemistry are naturally occurring reactions.*

The drainage chemistry from sulphidic geologic materials is a major concern for the mining industry. Many base and precious metal, and some coal and diamond mines, excavate and expose large amounts of sulphidic rock to air and water.

The exposure of large amounts of sulphidic geologic materials to air and water and the resulting drainage chemistry problems are not restricted to mining. Road building and other forms of construction can also excavate large amounts of sulphidic rock. Examples include the construction of roads for forestry (Koyanagi and Panteleyev, 1994), various highways (Daniels and Orndorff, 2003; Hammarstrom et al., 2005; Morin et al., 2003) and the Halifax Airport in Nova Scotia (Hicks, 2006). Sulphide oxidation resulting in acidic drainage and related problems may also arise when sulphidic marine sediments are drained, either naturally or by anthropogenic activities, such as farming (Pons et al., 1982).

### 5.1.3 Elements of Concern

Elements of concern due to their potential toxicity and abundance in some sulphidic geologic materials include: aluminum, antimony, arsenic, barium, beryllium, cadmium, chromium, cobalt, copper, iron, lead, manganese, mercury, molybdenum, nickel, selenium, silver, strontium, sulphur, thallium, and zinc. Antimony, arsenic, molybdenum, selenium and sulphur generally occur as oxyanions (e.g.  $\text{SO}_4^{2-}$ ) in oxidized environments. Aluminum, barium, beryllium, cadmium, chromium, cobalt, copper, lead, manganese, mercury, nickel, silver, strontium, thallium and zinc generally occur as cations (e.g.  $\text{Zn}^{2+}$ ).

The total concentration of an element in drainage is simplistically the sum of the concentrations of the element existing as dissolved species, either as free ions or complexes with ligands, and

the concentrations associated with suspended solids. The distinction between a dissolved and suspended element is often based on a filter size, such as 0.45  $\mu\text{m}$ . In reality, polymers and colloids may not behave geochemically as if they are either dissolved or suspended.

Toxicity is primarily chemical in nature and derived from dissolved concentrations. However, toxicity may also result from physical impacts, such as precipitation of iron oxyhydroxides and gypsum which prevents the aeration of fish eggs in stream gravels.

#### 5.1.4 Metal Leaching and Acid Rock Drainage

Metal leaching (ML) is a common problem associated with drainage derived from oxidizing sulphidic geologic materials. The term “metal” is used because elevated concentrations of major metals such as Fe and Al and trace metals such as Cu and Zn in the drainage are the most common cause of environmental concern. “Leaching” is used because dissolution and transport are required for problems to occur. However, the use of the term “metal leaching” for problems associated with the drainage chemistry of oxidizing sulphidic geologic materials is potentially misleading, because environmental impacts may also occur from elevated concentrations of metalloids such as As and non-metal species like Se and sulphate.

*Metal leaching is a common problem associated with drainage derived from oxidizing sulphidic geologic materials.*

Another common term used to refer to the drainage from oxidizing sulphidic geologic materials is “acid rock drainage (ARD)” or its alternative “acid mine drainage (AMD)”. However, the latter is less appropriate because acidic drainage from sulphidic materials is not produced solely by the mining industry. The term ARD is used because impacts are most common and often greater when the drainage is acidic due to the resultant higher rates of sulphide oxidation and other weathering reactions and higher solubility of many potentially harmful elements. Use of the term “acid rock drainage” for problems associated with the drainage chemistry derived from oxidizing sulphidic geologic materials is potentially misleading because environmental impacts may also occur from drainage with a near-neutral or basic pH.

Although often lower than at acidic pH, solubility limits and dissolved concentrations can still exceed environmental guidelines for elements, such as antimony, arsenic, cadmium, cobalt, manganese, mercury, nickel, selenium and zinc, released by the oxidation and dissolution of sulphide minerals (Stantec Consulting Ltd., 2004). In contrast, the solubility of molybdenum can be higher in near-neutral and alkaline drainage compared to acidic drainage. Even metals, such as Al, Fe, and Cu, whose solubility is greatly reduced at near-neutral compared to acidic pH's, can exceed environmental guidelines if there is insufficient dilution and attenuation prior to entering a sensitive receiving environment.

### 5.1.5 Acid, pH, Acidity and Alkalinity

An acid is a substance that can donate a hydrogen ion ( $H^+$ ) to another substance and a base is one that can donate a hydroxide ion. pH is a measure of hydrogen ion activity [ $H^+$ ] in solution. The pH scale is based on the negative logarithm to the base 10 of the hydrogen ion activity and a decrease of one pH unit corresponds to an order of magnitude increase in hydrogen ion activity.

*An acid is a substance that can donate a hydrogen ion to another substance and a base is one that can donate a hydroxide ion.*

The strict chemical definitions of categories of drainage chemistry based on pH are:

- neutral pH is pH 7 with equal aqueous activity of hydrogen and hydroxide ions;
- an acidic drainage has an excess of hydrogen ions and a pH value lower than 7; and
- a basic or alkaline drainage has an excess of hydroxide ions and a pH value greater than 7.

This Manual more generally defines a near-neutral pH as between 6.0 to 8.0, an acidic pH as  $< 6$  and an alkaline pH as  $> 8.0$ .

Acidic drainage is derived from materials with an insufficient capacity to neutralize all the acidic products of sulphide and elemental sulphur oxidation and the dissolution of acidic sulphate minerals. In the context of mining, this may be referred to as acid mine drainage (AMD).

The onset of acidic drainage is the first appearance of acidic pH values in drainage. Detection sensitivity will depend on the monitoring location(s) and frequency. Zones of pervasive acid weathering, with significant ARD generation, may occur locally or internally within a particular mine component, prior to the detection or occurrence of persistent acidic drainage pH values at a downstream monitoring point.

The point of concern regarding pH is site specific and will depend on:

- availability, weathering and solubility of the contaminants of concern;
- government guidelines; and
- intended usage of the water.

Drainage acidity and alkalinity are analytically determined measures of the capacity of a solution to neutralize a strong base and acid, respectively. Acidity and alkalinity are measured by titration. Their concentrations depend on the drainage chemistry and the prescribed pH end point used in the titration, which should be always be noted (e.g. acidity to pH 8.3).

Acidity is a measure of the concentration of hydrogen ions and certain dissolved metal ions and complexes, such as aluminum and iron, capable of producing excess hydrogen ions, at some point over the defined range in titration pH. Acidity provides a measure of the amount of lime a treatment plant would require to raise the pH and precipitate metals. The acidity of a solution generally increases as its pH decreases. However, solutions with similar pH values may have very different acidities.

Near-neutral oxic drainage may have low concentrations of aluminum, iron and hydrogen ions, yet still have elevated concentrations of acidity to pH 8.3. For example, sphalerite oxidation can produce near-neutral drainage with elevated acidity in the form of dissolved zinc. Anoxic drainage with a near-neutral pH can contain elevated acidity in the form of  $\text{Fe}^{2+}$ .

The alkalinity concentration depends on the excess bicarbonate, carbonate and hydroxide in solution or the ability of a dissolving solid to produce an excess of such bases.

Net drainage pH refers to the overall drainage pH for a specified sulphidic geologic material, at present or at some time in the future. Procedures used to measure or predict the net drainage pH and the assumed future geochemical conditions should be clearly identified. Unless otherwise specified, geologic constituents are assumed to be exposed to oxidizing weathering conditions with sufficient time for complete oxidation of the sulphide minerals.

The net drainage pH will depend on the cumulative rates of acid and base addition from all contributing internal and external sources. External sources may include dust, precipitation and groundwater. Internal sources include mineral weathering and the reactions of organic and dissolved species. Differences in the cumulative rates of acid generation and acid neutralization and thus drainage pH, may occur:

- at the micro-scale level (e.g. porewater);
- in different rock types and locations in mine component (e.g. surface, sub-surface) with different weathering conditions (e.g. aerobic or flooded locations); and
- with different times of exposure (e.g. present or sometime in the future).

Where possible, differences in the rates of acid and base addition, acid neutralization and drainage pH at different scales, locations, times and under different weathering conditions should be indicated (e.g. net acidic drainage at the surface of tailings in the future).

Net acidic material if leached will immediately produce acidic drainage. An acidic rinse pH is

*Net acidic material if leached will immediately produce acidic drainage.*

evidence that a sample is presently net acidic. Although a mine component or sample as a whole is net acidic, some portion of the surface of particles or fracture surfaces (micro-sites) and the interior of particles may produce alkaline or near-neutral pH drainage. Neutralization Potential (NP) measured

in a net acidic mine component or sample is either physically unavailable (e.g. occluded within particles and not exposed to air or drainage) or insufficiently reactive to produce near-neutral pH or alkaline drainage.

Net neutral sulphidic geologic material if leached produces near-neutral pH drainage. This results from equal rates of acid neutralization and acid generation.

Acid Potential (AP) measured in a presently neutralized mine component or sample is (1) physically unavailable (e.g. partially occluded within particles and not exposed to air or drainage) or (2) presently insufficiently reactive to produce acidity.

Net alkaline material if leached will produce drainage with basic pH. Although a mine component or sample is predominantly near-neutral or alkaline, some parts, grains or fracture surfaces may produce acidic drainage.

## 5.2 Weathering Processes and Reactions

Weathering is the name given to the processes by which geologic materials (e.g. bedrock, rock particles and minerals) are altered on exposure to surface temperature and pressure, and to atmospheric agents such as air, water and biological activity (Ollier, 1969; Birkeland, 1974).

*Weathering is the name given to the process by which geologic materials are altered on exposure to atmospheric conditions and agents.*

Weathering reactions are responsible for the majority of the chemical species in the drainage from geologic materials, reflecting chemical and physical instability, although other sources can include:

majority of the chemical species in the drainage from geologic materials, reflecting chemical and physical instability, although other sources can include:

- wind borne sediment;
- water borne sediment;
- organic matter;
- inflowing drainage; and
- atmospheric inputs.

Because weathering includes both physical processes and chemical reactions, it may alter the physical and/or chemical properties.

Drainage chemistry from sulphidic geologic materials depends on the net result of all weathering processes. Although sulphide oxidation and the dissolution of oxidation products are a major source of the chemical species in the drainage, other weathering reactions and the weathering of other minerals will contribute chemical species in solutions and affect the release and solubility of chemical species from sulphide minerals.

For example, physical weathering and the precipitation of weathering products will influence the exposure of sulphide minerals to oxygen. Carbonate dissolution will neutralize acidity and is often the major source of calcium and magnesium. Hydrolysis and cation exchange reactions with silicates and hydroxides often cause the release of sodium and potassium. Redox reactions may increase or decrease the solubility of secondary minerals formed from the products of sulphide oxidation. Consequently, an understanding of all the weathering processes and reactions is required when designing a prediction program and analyzing the results.

Physical weathering processes include:

- unloading due to excavation;
- thermal expansion and contraction of minerals; and
- ice and salt crystal formation and plant root growth in fractures and cracks.

Chemical weathering reactions include:

- hydration;



- cation exchange;
- hydrolysis;
- oxidation and reduction; and
- dissolution and precipitation.

Properties of the solid phase, drainage chemistry and solutes that are important in determining the mechanism, rate and products of weathering reactions are provided below (Langmuir et al., 2004).

#### Solid Phase:

- mineral type and chemical composition,
- organic matter,
- surface coatings,
- surface area and site density or exchange capacity of anion and cation sorbing solids,
- aeration, and
- microbial activities and rates.

#### Drainage Chemistry:

- pH,
- Eh,
- dissolved oxygen,
- solute composition and concentrations (activities),
- dissolved organic carbon,
- ionic strength, and
- temperature.

#### Solutes:

- chemical species and speciation,
- complexation chemistry,
- solubility,
- precipitation chemistry,
- oxidation reduction behaviour, and
- vapor pressure.

### **5.2.1 Physical Changes Resulting from Weathering**

The main contributions of physical weathering are fracturing and breaking particles, increasing the surface area and exposing fresh mineral surfaces to chemical weathering. Because chemical weathering reactions are surface dependent, the physical weathering processes, such as hydration and thermal expansion and contraction that increase the surface area, also increase the rate of chemical weathering reactions. For example, breaking apart and increasing the surface area of a unit mass of sulphide minerals will increase the overall rate of sulphide oxidation and metal leaching. However, if the reduction in particle size is large enough to reduce air entry and water percolation, it may reduce the rate of dissolution and oxidation.

Temperature changes may create fractures along mineral grain boundaries and break apart minerals that differ in their rates of thermal expansion and contraction. The growth of ice and salt crystals along grain boundaries can create and increase the size of fractures. Salt crystals may form due to increases in solute concentrations resulting from other weathering reactions or evaporation. Rock particles may also be fractured and broken apart by chemical weathering as dissolution, hydration and cation exchange reactions expand or reduce the size of crystal grains.

### 5.2.2 Dissolution and Precipitation

Dissolution refers to the entrainment of soluble chemical species by water. Dissolved species are generally free ions or complexes with a ligand, although neutral species (e.g.  $\text{H}_4\text{SiO}_4$ ) can also occur. Ligands are either an anion or a neutral molecule. Common ligands include hydroxyl, carbonate, bicarbonate, and sulphate ions.

*Dissolution refers to the entrainment of soluble chemical species by water.*

Reaction 5.1 shows the production of zinc cation and sulphate anion as the result of oxidative dissolution of sphalerite.



In near-neutral drainage, calcium is often the cation present in the highest concentration. Gypsum precipitates (reverse of Reaction 5.2) when the rates of sulphide oxidation and of reactions releasing calcium into solution produce concentrations of sulphate and calcium that exceeds gypsum's solubility limit.



Non-sulphate sources for calcium include a number of carbonate and silicate minerals.

Dissolution of carbonate minerals is accelerated by, and neutralizes the acidity produced by, sulphide oxidation (Reaction 5.3) and by carbonic acid (Reaction 5.4).



Carbonic acid is formed by the dissolution of  $\text{CO}_2$  in water.



Section 5.6.1 contains further discussion of the dissolution of carbonate minerals.

The concentration of different dissolved complexes and free ions will depend on drainage chemistry properties such as pH and the concentration of alkalinity and other major anions and cations. The major inorganic species in a hypothetical pH 8, oxygenated drainage are listed in Table 5.1.

**Table 5.1 Major inorganic species in hypothetical pH 8, oxygenated drainage (from Langmuir et al., 2004 and based on Stumm and Morgan, 1996); the right column is the percentage of the total metal concentration occurring as free ion.**

Condition	Metal/Element	Major Species	Percent as Free Metal Cation
Oxyanions	As(V)	$\text{HAsO}_4^{2-}$	
	Cr(VI)	$\text{CrO}_4^{2-}$	
	Mo(VI)	$\text{MoO}_4^{2-}$	
	Se(VI)	$\text{SeO}_4^{2-}$	
	V(V)	$\text{HVO}_4^{2-}$ , $\text{H}_2\text{VO}_4^-$	
Predominantly free aquo-ions	$\text{Na}^+$	$\text{Na}^+$	100
	$\text{K}^+$	$\text{K}^+$	100
	$\text{Mg}^{2+}$	$\text{Mg}^{2+}$	94
	$\text{Ca}^{2+}$	$\text{Ca}^{2+}$	94
	$\text{Sr}^{2+}$	$\text{Sr}^{2+}$	94
	$\text{Ba}^{2+}$	$\text{Ba}^{2+}$	95
Complexed with $\text{OH}^-$ , $\text{CO}_3^{2-}$ , $\text{HCO}_3^-$ , $\text{Cl}^-$	Ag(I)	$\text{Ag}^+$ , $\text{AgCl}^0$	60
	Al(III)	$\text{Al}(\text{OH})_3(\text{s})$ , $\text{Al}(\text{OH})_2^+$ , $\text{Al}(\text{OH})_4^-$	$1 \times 10^{-7}$
	Be(II)	$\text{BeOH}^+$ , $\text{Be}(\text{OH})_2^0$	0.15
	Cd(II)	$\text{Cd}^{2+}$ , $\text{CdCO}_3^0$	50
	Co(II)	$\text{Co}^{2+}$ , $\text{CoCO}_3^0$	50
	Cu(II)	$\text{CuCO}_3^0$	2
	Fe(III)	$\text{Fe}(\text{OH})_3(\text{s})$ , $\text{Fe}(\text{OH})_2^+$ , $\text{Fe}(\text{OH})_4^-$	$2 \times 10^{-9}$
	Hg(II)	$\text{Hg}(\text{OH})_2^0$	$1 \times 10^{-8}$
	Mn(IV)	$\text{MnO}_2(\text{s})$	
	Ni(II)	$\text{Ni}^{2+}$ , $\text{NiCO}_3^0$	40
	Pb(II)	$\text{PbCO}_3^0$	5
	Tl(I), Tl(III) <sup>a</sup>	$\text{Tl}^+$ , $\text{Tl}(\text{OH})_3$ , $\text{Tl}(\text{OH})_4^-$	$2 \times 10^{-19}$
	Zn(II)	$\text{Zn}^{2+}$ , $\text{ZnCO}_3^0$	40

Solid liquid interactions can separate dissolved chemical species into insoluble or solid forms. This may occur through:

- ion exchange onto mineral surfaces and organic matter (Section 5.2.7);
- co-precipitation or adsorption as a trace or minor impurity into a mineral or amorphous solid phase; and
- precipitation as a mineral.

Dissolved species may precipitate, forming the major component of a mineral when their concentrations exceed a mineral's solubility limit. If the rates of mineral dissolution and precipitation are relatively rapid, mineral solubility limits will control the maximum concentrations of dissolved chemical species. The dissolved concentration of a chemical species may exceed the solubility limit if the rate of precipitation is relatively slow or the rate of dissolution exceeds the rate of precipitation.

*Dissolved species may precipitate, forming the major component of a mineral when their concentrations exceed a mineral's solubility limit.*

The identity of dissolved and precipitated chemical species, the solubility limits and maximum dissolved concentrations depend on a large number of factors. Some of the most important are elemental speciation and the pH and Eh (redox) of the drainage. Changes in the pH and redox may dramatically alter the nature of dissolved species, mineral solubility and maximum dissolved elemental concentrations. The impact of redox on solubility is discussed in Section 5.2.3. The impact of pH and Eh on the solubility and speciation of iron determines some key aspects of sulphide oxidation.

Aqueous complexes play a major role in the solution and precipitation of elements in the environment. Mineral precipitation is controlled by the activity product of the pertinent free ions and not the aqueous complexes. Therefore, the higher the proportion of the total dissolved concentration of ions in aqueous complexes, the higher the total ion concentration must increase in order to reach the mineral solubility or saturation limits. For example, an increase in the concentration of dissolved  $\text{ZnCO}_3^0$  will increase the total dissolved Zn concentration, but will not increase the concentration of free Zn ions or the solubility limit for solid Zn carbonate.

The formation of dissolved complexes also influences adsorption. Metal carbonate and sulphate complexes are usually poorly adsorbed to organic matter and mineral surfaces, whereas metal hydroxide complexes are strongly adsorbed (Langmuir et al., 2004).

Dissolution of some metals that are relatively insoluble at near-neutral pH, such as Al, Fe or Cu, may be increased if they bond with organic acids and form soluble organic complexes. Complexation or chelation can increase the leachability and reduce the toxicity of some elements. The maximum dissolved concentration of one particular chemical species may also be changed by the presence of other anions and cations. For example, the maximum aqueous concentration for sulphate is much lower in the presence of high concentrations of Ca than high concentrations of Mg because of the much lower solubility of  $\text{CaSO}_4$  compared to  $\text{MgSO}_4$ .

Further discussion of dissolution and precipitation occurs in Chapter 20 on Modeling Drainage Chemistry.

### 5.2.3 Oxidation and Reduction (Redox)

Oxidation is the process of losing an electron and increasing the valence. Reduction is the process of gaining an electron and decreasing the valence. Examples of oxidation reactions are as follows:

Oxidation of ferrous iron (+2) to ferric iron (+3)



Oxidation of the +2 form of the manganese ion to the +4 form and the precipitation of pyrolusite



Oxidation of the -2 sulphide-sulphur in galena to +6 sulphate-sulphur in the relatively insoluble anglesite



Oxidation reactions are often reversible with sufficiently reducing conditions and time.

The order of redox reactions occurring as a function of Eh is shown in Figure 5.1. Notably, oxidation of sulphide to sulphate typically precedes the oxidation of ferrous iron to ferric iron. This is why high concentrations of ferrous iron can appear in the drainage from rapidly oxidizing sulphidic geologic materials. With a decrease in the redox potential, reduction of ferric iron to ferrous iron often precedes the reduction of sulphate to sulphide, followed by the precipitation of Fe(II) sulphides and less abundant sulphides of Cd, Zn, Co, Ni, Pb, Ag, Cu, Hg, and Mo.

Electron transfer in oxidation/reduction reactions generally involves only one or two electrons in each step. Consequently, if there is a large change in valence, such as the case for sulphur, redox reactions often involve a number of steps. The oxidation of manganese is potentially complicated by the fact that there are two valence states, +3 and +4, higher than the +2 manganous ion and a number of more complex manganese oxide minerals contain manganese in more than one valence state.

Redox reactions may be catalyzed by bacteria. Oxidation reactions may be catalyzed by chemolithotrophic bacteria, such as *Acidithiobacillus* and *Thiobacillus* species that use the energy released by the oxidation. Reducing bacteria use the oxidized chemical species as a terminal electron acceptor to oxidize organic carbon. Sulphide produced from sulphate by reducing bacteria may then precipitate metals as metal sulphides.

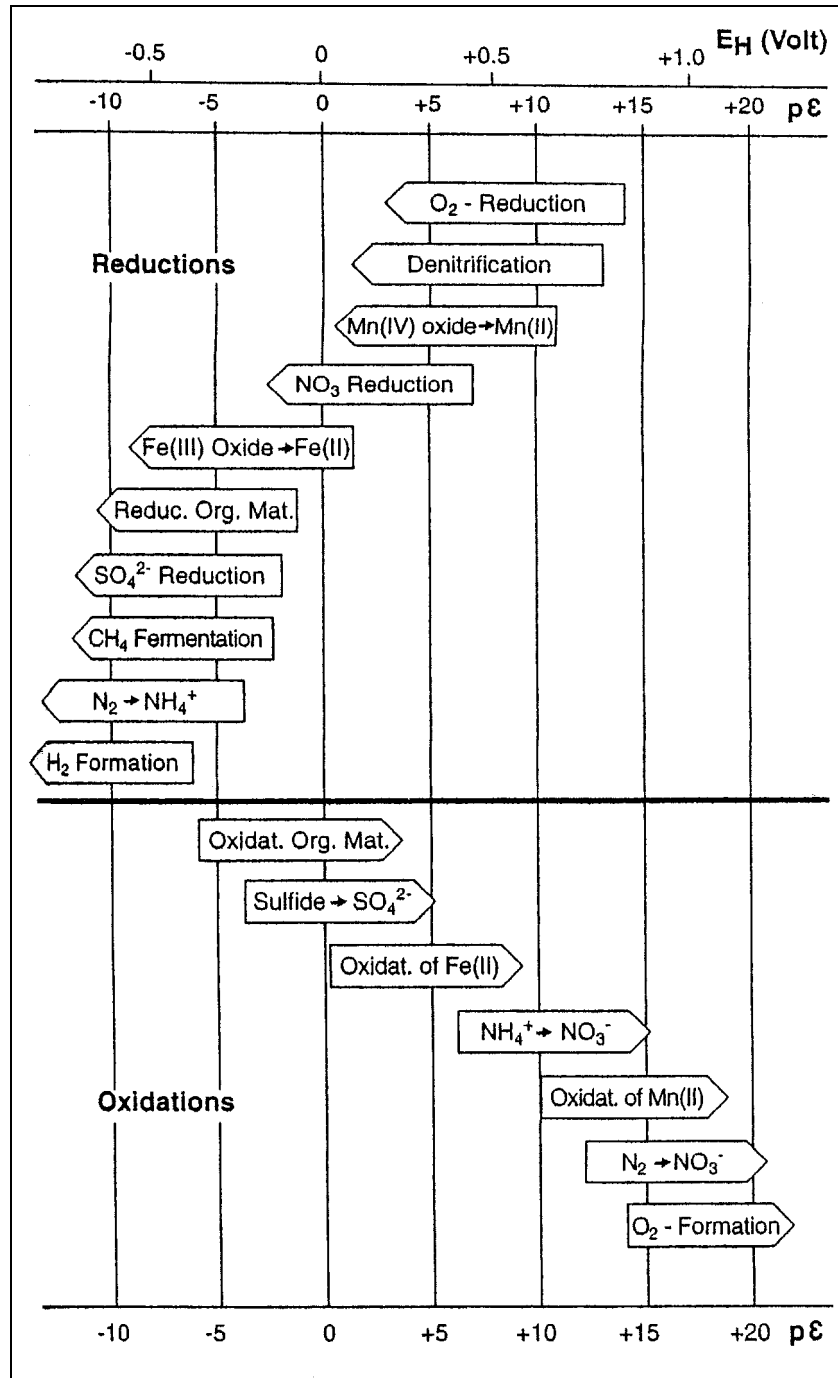


Figure 5.1 The Eh and sequence of oxidation-reduction reactions. From Langmuir et al., 2004 (modified from Stumm and Morgan, 1996).

Oxidation and reduction reactions change both the size and charge of an ion, disrupting minerals directly or indirectly by accelerating other weathering reactions such as hydrolysis and hydration. Consequently, minerals containing reduced S, Fe and Mn typically weather more rapidly under oxidizing conditions. Although oxidation reduces the ionic radius, it can also increase the degree of hydration. The resultant changes in the size of mineral grains may weaken the strength of the rock particles.

*Oxidation and reduction reactions change both the size and charge of an ion, disrupting minerals directly or indirectly by accelerating other weathering reactions.*

The oxidation state of some elements in water is shown in Table 5.2. Trace elements with more than one common valence include Cr(III and VI), Cu(I and II), Hg(0, I and II), Mn(II, III and IV), Sb(III and V) and Se(-II, 0, IV and VI). Different valence states change the reaction of elements with biological functions and often affect their toxicity. As(III) is more toxic than As(V) and is also the precursor of methylated As species. The opposite is true for chromium, where the reduced species Cr(III) is much less toxic than Cr(VI).

Changes in valence also changes elemental solubility. For example at near-neutral pH, the oxidized forms of iron and manganese, Fe(III) and Mn(IV), readily hydrolyze forming insoluble secondary minerals, whereas Fe(II) and Mn(II) are relatively soluble. The redox state of iron and manganese also impacts adsorption and co-precipitation and therefore the solubility of trace elements. Fe(III) and Mn(IV) oxyhydroxides produced by weathering or during processes such as roasting and drainage treatment can co-precipitate or adsorb a large number of trace elements and are especially effective in co-precipitating those that exist as anions, such as arsenic, antimony and molybdenum. Consequently, a layer of Fe(III) and Mn(IV) hydroxide or oxyhydroxide can be effective in scavenging potentially toxic elements, thereby minimizing their concentration in solution.

Reductive dissolution of Fe(III) and Mn(IV) oxides produces not only Fe(II) and Mn(II) ions but also releases co-precipitated trace elements into solution. The process is responsible for the trace element release observed from the decrease in redox potential when soluble carbon or nutrients are imported into impoundments storing lime treatment sludge, roaster products or weathered mine wastes.

**Table 5.2 Common oxidation states, oxidized forms, and reduced forms in water are the best predictors of toxicity for trace metals (adapted from Langmuir et al., 2004; oxidation states in parentheses are found in mineral systems only).**

<b>Metal</b>	<b>Oxidation States</b>	<b>Oxidized Forms</b>	<b>Reduced Forms</b>	<b>Best Predictor of Toxicity</b>
Aluminum	3+	Al <sup>3+</sup>	Al <sup>3+</sup>	
Beryllium	2+	Be <sup>2+</sup>	Be <sup>2+</sup>	Be <sup>2+</sup>
Barium	2+	Ba <sup>2+</sup>	Ba <sup>2+</sup>	Ba <sup>2+</sup>
Strontium	2+	Sr <sup>2+</sup>	Sr <sup>2+</sup>	
Cadmium	2+	Cd <sup>2+</sup>	Cd <sup>2+</sup>	Cd <sup>2+</sup>
Zinc	2+	Zn <sup>2+</sup>	Zn <sup>2+</sup>	Zn <sup>2+</sup>
Cobalt	(3+), 2+	(Co <sup>3+</sup> ), Co <sup>2+</sup>	Co <sup>2+</sup>	Co <sup>2+</sup>
Nickel	(3+), 2+	(Ni <sup>3+</sup> ), Ni <sup>2+</sup>	Ni <sup>2+</sup>	Ni <sup>2+</sup>
Manganese	(4+), (3+), 2+	(Mn <sup>4+</sup> ), Mn <sup>2+</sup>	(Mn <sup>3+</sup> ), Mn <sup>2+</sup>	Mn <sup>2+</sup>
Lead	(4+), 2+	Pb <sup>2+</sup>	Pb <sup>2+</sup>	Pb <sup>2+</sup>
Silver	1+, (0)	Ag <sup>+</sup>	Ag <sup>+</sup> /Ag(s)	Ag <sup>+</sup>
Copper	2+, 1+, 0	Cu <sup>2+</sup>	Cu <sup>+</sup> /Cu(s)	Cu <sup>2+</sup>
Mercury	2+, 1+, 0	Hg <sup>2+</sup>	Hg <sup>+</sup> /Hg(l)	CH <sub>3</sub> Hg
Thallium	(4+), (3+), 1+	(Tl <sup>4+</sup> ), (Tl <sup>3+</sup> )	Tl <sub>2</sub> O(s)/Tl <sup>+</sup>	
Arsenic	5+, 3+, 0	HAsO <sub>4</sub> <sup>2-</sup>	H <sub>3</sub> AsO <sub>3</sub> <sup>0</sup> /As(s)	AsO <sub>4</sub> <sup>3-</sup>
Antimony	5+, 3+, 0	Sb(OH) <sub>6</sub> <sup>-</sup>	Sb(OH) <sub>3</sub> <sup>0</sup> /Sb(s)	
Chromium	6+, 3+	CrO <sub>4</sub> <sup>2-</sup>	Cr <sup>3+</sup> , Cr(OH) <sub>3</sub> (s)	CrO <sub>4</sub> <sup>2-</sup>
Molybdenum	6+, (5.33+), 5+, (4+)	HMoO <sub>4</sub> <sup>-</sup>	MoO <sub>2</sub> <sup>+</sup> /Mo <sub>3</sub> O <sub>8</sub> (s)/ MoS <sub>2</sub> (s)	MoO <sub>4</sub> <sup>2-</sup>
Selenium	6+, 4+, (0), 2-	SeO <sub>4</sub> <sup>2-</sup>	SeO <sub>3</sub> <sup>2-</sup> /Se(s)/ HSe <sup>-</sup>	SeO <sub>4</sub> <sup>2-</sup>
Vanadium	5+, 4+, 3+	H <sub>2</sub> VO <sub>4</sub> <sup>-</sup>	VO <sup>2+</sup> , V(OH) <sub>3</sub> <sup>0</sup>	



### 5.2.4 Galvanic Effects

Sulphide minerals are semi-conductors and vary in their rest potential<sup>8</sup>. The higher the rest potential, the harder it is to oxidize the mineral. In the presence of an electrolyte such as water and with good physical contact between sulphide mineral grains with differing electrode potential, galvanic (electrochemical) interaction may increase the rate of oxidative dissolution of the mineral with the lower rest potential (anode) and impede oxidation of the sulphide mineral with a higher rest potential (cathode). Therefore, galvanic interactions may control the sequence in which a suite of sulphide minerals oxidize (Kwong et al., 2003).

The rest potential of selected sulphide minerals measured in 1.0 M H<sub>2</sub>SO<sub>4</sub> at room temperature is shown in Table 5.3. This table should only be used as a general guide to the relative reactivity of different sulphide minerals for several reasons. Similar to other weathering properties, the rest potential of sulphide minerals varies with their relative concentration of major chemical constituents and trace contaminants, the surrounding drainage chemistry and other site specific factors. It is also important to note that the physical contact between grains of different sulphide minerals required for galvanic interactions usually only occurs if the sulphide mineral concentrations are high or the sulphide minerals are concentrated in one area, such as a vein.

**Table 5.3 Rest potential of selected sulphide minerals  
(adapted from Kwong et al., 2003).**

Mineral	Formula	Rest Potential (in volts vs. SHE*)
Pyrite	FeS <sub>2</sub>	0.63
Chalcopyrite	CuFeS <sub>2</sub>	0.52
Chalcocite	Cu <sub>2</sub> S	0.44
Covellite	CuS	0.42
Galena	PbS	0.28
Sphalerite	ZnS	-0.24
Pyrrhotite	Fe <sub>(1-x)</sub> S	-0.28

\*Standard hydrogen electrode

Notably, pyrite among the common sulphides has the highest rest potential. Also, variability in the rest potential of pyrite is less than that between pyrite and other sulphide minerals (Abraitis et al., 2004).

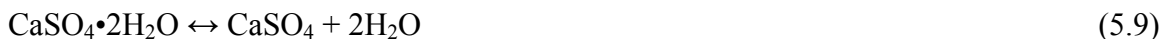
Differences in the timing of oxidation of different sulphide minerals due to galvanic interaction may have a large impact on the evolution of drainage chemistry. Galvanic interaction observed at the Red Dog mine, between sphalerite (ZnS), pyrite (FeS<sub>2</sub>) and galena (PbS), accelerated the oxidation of sphalerite and delayed the oxidation of pyrite and galena (Day et al., 2003).

<sup>8</sup> Rest potential is defined as, “The potential difference across the mineral-solution interface when the mineral is at electrical equilibrium with respect to electrochemical processes” (Abraitis et al., 2004).

The oxidation of sphalerite at Red Dog produced near-neutral pH drainage, with elevated zinc. Similar drainage chemistry associated with a delay in pyrite oxidation until sphalerite is depleted is also observed in the massive sulphide tailings at the Faro Mine.

### 5.2.5 Hydration and Dehydration

Hydration and dehydration refers to the addition and removal of water molecules. In Reaction 5.9, gypsum is dehydrated, forming anhydrite and in the reverse reaction anhydrite is hydrated, forming gypsum.



The increase in mineral volume accompanying hydration can cause physical disintegration of rock particles.

### 5.2.6 Hydrolysis

Hydrolysis refers to a water molecule splitting into hydronium (hydrogen) and hydroxide ions, as shown in Reaction 5.10, where these ions can then alter the structure of a pertinent mineral.



Hydrolysis reactions where the hydrogen ion replaces a base cation are major weathering processes for common silicate minerals.

Hydrolysis of K-feldspar with hydrogen from Reaction 5.10 replacing  $\text{K}^+$  is:



The replacement of base cations by hydrogen ions in hydrolysis is accelerated by an increase in the hydrogen ion concentration. Thus, a decrease in pH typically increases the rate of silicate mineral weathering. Potential sources of hydrogen ions include organic acids produced from decomposing vegetation, carbonic acid ( $\text{H}_2\text{CO}_3$ ) and acidity produced by sulphide oxidation. Silicate hydrolysis is the major acid neutralization mechanism in near-neutral pH, carbonate free geologic materials. Less well bound cations on broken edges of mineral grains or interlayer base cations in clay minerals are especially susceptible to removal by hydrolysis. This is particularly true if the minerals have a high surface area (e.g. fine grained), physical flaws and charge imbalances (Jambor et al., 2005).

*Hydrolysis reactions where the hydrogen ion replaces a base cation are major weathering processes for common silicate minerals.*

The hydroxide ion of Reaction 5.10 may also be consumed by a hydrolysis reaction. Consumption of a hydroxide ion and the production of acidity occur in the hydrolysis of Al and Fe ions, which are reversible reactions and typically buffer the pH between 4.5 and 5.5 and 3.0 and 3.5, respectively.

Hydrolysis of  $\text{Al}^{3+}$  releases  $3 \text{H}^+$  as follows:



Hydrolysis of  $\text{Fe}^{3+}$  also releases  $3 \text{H}^+$  as shown in Reaction 5.13:



### 5.2.7 Ion Exchange

In addition to precipitation as secondary minerals, dissolved chemical species may also be

*Dissolved chemical species may be removed from solution by exchange with weakly held ions or ions adsorbed on positively or negatively charged surfaces.*

removed from solution by exchange with weakly held ions or ions adsorbed on positively or negatively charged surfaces. Ion exchange reactions are usually controlled by the mass balance of ions in solution and on the exchange sites and result in the release of the exchanged ions into solution until the exchange is complete. Benefits of ion exchange include lowering

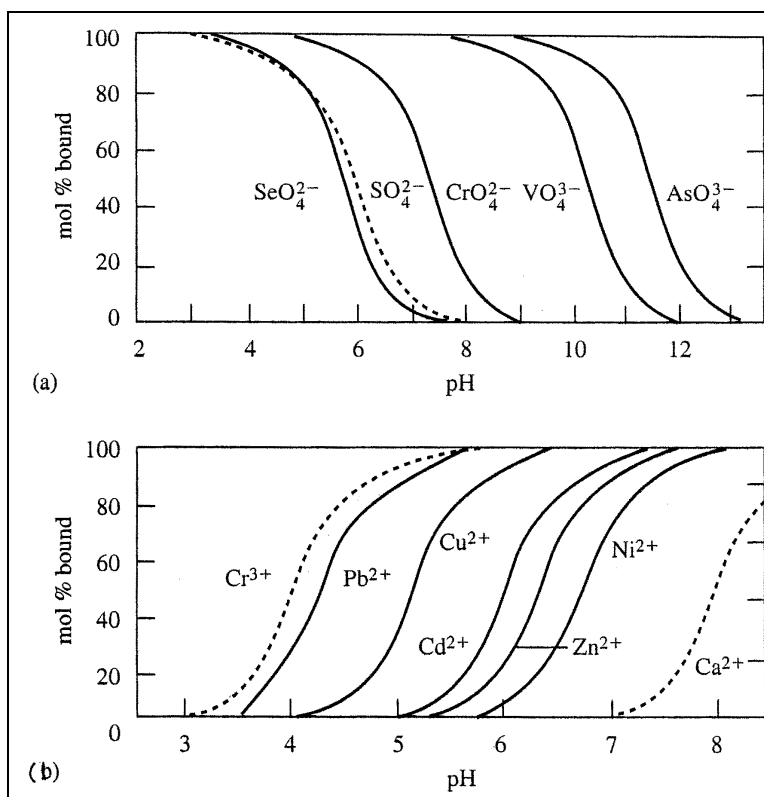
the concentration of potentially toxic elements and acidity released into solution by sulphide oxidation. A potential disadvantage is that the exchange of alkali and alkaline earth metals with protons on exchange sites in naturally acidic soils may result in a short term decrease in the seepage pH after the addition of high salinity mine water until exchange is complete.

The materials with the highest unit mass ion exchange capacities are clay minerals, organic matter, and oxyhydroxides of Al, Fe and Mn. Fe and Al oxyhydroxides and organic acids can strongly influence the store and release of trace elements, as well as the transport of the latter when occurring as mobile colloids.

The surface charge of clays, except for kaolinite, is largely independent of pH, whereas the surface charge of organic matter and the oxyhydroxides is strongly pH dependent (Langmuir et al., 2004). Organic matter and kaolinite typically remain negatively charged at low pH. On the other hand, oxyhydroxides have positive surface charges at low pH and the positive surface charge increases as the pH decreases, making these phases more effective exchange sites for anions under low pH conditions (Figure 5.2). Oxyhydroxides also have negative surface charges at high pH, and the exchange capacity for metals thus increases with increasing pH (Figure 5.2).

### 5.2.8 Microbial Action

Microbial action can increase the rates of many chemical and physical weathering processes (Nordstrom and Alpers, 1999). One well known example is the microbial catalysis of ferrous iron oxidation at low pH with the resultant dissolved ferric iron oxidizing pyrite. By increasing the concentration of ferric iron, the bacteria may increase iron hydrolysis or the rate of sulphide oxidation (Nordstrom, 2003). Research suggests that the microbial communities involved in sulphide oxidation and the weathering of sulphidic geologic materials is complex, with many different microbial species and supportive interrelationships that have yet to be identified.



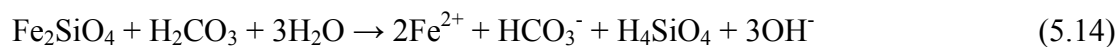
**Figure 5.2.** Adsorption of various metal cations and oxyanions, each at  $5 \times 10^{-7}$  M, by ferrihydrite ( $[\text{Fe(III)}] = 10^{-3}$  M) as a function of pH at an ionic strength of 0.1 mol/kg. There are  $2 \times 10^4$  M of reactive sites on the oxyhydroxide. The dashed curves are calculated (from Langmuir et al., 2004, after Stumm, 1992).

### 5.2.9 Mineral Alteration by a Combination of Weathering Reactions

Mineral alteration often involves a number of different weathering reactions occurring simultaneously or in series. The sequence of weathering reactions depends on the sequence of weathering conditions and is very important in determining the drainage chemistry. Previous weathering may contribute to future weathering by:

- changing a particle, chemical compound or element into a form that dissolves relatively quickly (kinetically reactive) and has relatively high solubility (thermodynamically reactive); or
- changing the drainage chemistry into such a composition that facilitates fast dissolution of chemical species or minerals (kinetically reactive) and in relatively high concentrations (thermodynamically reactive).

In Reaction 5.14 for example, ferrous iron is released by the hydrolysis of fayalite by carbonic acid. Ferrous iron is relatively soluble and may remain in dissolved form under neutral pH and reducing conditions. If sufficiently oxidizing conditions exist, the dissolved ferrous iron would oxidize to ferric iron, which at neutral pH is no longer soluble and would mostly precipitate as a ferric mineral such as the hydroxide shown in Reaction 5.13.



Oxidation of ferrous to ferric iron may occur in the crystal lattice, with the change in valence of iron disrupting the charge balance. Other cations may then leave the crystal lattice to maintain neutrality. This in turn may cause the lattice to collapse or be more vulnerable to other weathering processes. Common minerals containing iron that may exhibit this form of weathering include amphiboles, biotite and chlorite.

*An important weathering sequence occurs when oxidized conditions are followed by reducing conditions resulting in reductive dissolution of previously precipitated products of sulphide oxidation.*

A potentially important weathering sequence occurs when oxidized conditions are followed by reducing conditions resulting in reductive dissolution of previously precipitated products of sulphide oxidation (Section 5.3.3). Reductive dissolution of previously precipitated products of sulphide oxidation often results in high drainage concentrations of trace elements, such as arsenic, previously co-precipitated with Fe(III).

### 5.2.10 Rate of Weathering

The rate of weathering and the resulting chemical species released will depend on the:

- chemical and physical composition of the weathering geologic materials;
- chemical and physical environmental conditions, including the supply of reactants, pH, temperature and Eh; and
- form of chemical and physical instability.

Mineral weathering rates depend on a number of compositional variables (Jambor and Blowes, 1994; Plumlee et al., 1999; Abraitis et al., 2004):

- exposed mineral surface area;
- mineralogy;
- electrochemical properties such as rest potential;
- stoichiometric differences in the ratio of major constituents;
- crystal morphology and structural defects; and
- trace elements impurities.

The rate of weathering may vary widely. Physically and chemically unstable geologic materials may persist if:

- their rate of removal is lower than their rate of formation; or
- the length of weathering has been insufficient.

## 5.3 Sulphur Species

Sulphur containing minerals are the primary sources of acidity and several contaminant elements in sulphidic geologic materials. The types of reaction, the chemical species released and the reaction rates are a function of the:

- oxidation state of the sulphur;
- major, minor and trace cations bonded with the sulphur; and
- weathering and leaching conditions.

The primary reduced inorganic sulphur species are sulphide and sulphosalt minerals.

The most oxidized inorganic sulphur species found in nature are sulphate minerals ( $\text{SO}_4^{2-}$ ).

Sulphur species with intermediate oxidation states include elemental sulphur and thiosalts. Thiosalts are partially oxidized sulphur oxyanions (e.g.  $\text{S}_2\text{O}_3^{2-}$ ,  $\text{S}_3\text{O}_6^{2-}$  and  $\text{S}_4\text{O}_6^{2-}$ ).

The fourth category of sulphur species is organic sulphur, which may occur in geologic materials that contain organic matter. These include coal, mudstones, organic surficial materials, such as peat and other geologic materials that presently or in the past have supported plant growth.

### 5.3.1 Sulphide Minerals

A sulphide mineral is an inorganic compound characterized by the linkage of a disulphide ( $\text{S}_2^{2-}$ ) or monosulphide ( $\text{S}^{2-}$ ) with a metal (e.g. Pb in galena). A sulphosalt is a sulphide mineral containing a metalloid in addition to a metal (e.g. As in arsenopyrite). Monosulphide minerals with sulphur in the negative two (-2) oxidation state include galena, sphalerite, and pyrrhotite. Disulphides with sulphur in the net negative one (-1) oxidation state include pyrite and marcasite.

Sulphide minerals form the majority of ore minerals and are the primary sources of many potentially deleterious elements and acidity, especially in unweathered sulphidic geologic materials.

Information on the formula and structure of sulphides as well as other minerals can be found on the internet and in a wide range of mineralogical texts. Table 5.4 shows the formulae of the main structural components of some common sulphide minerals, grouped according to the ratio of sulphur to metal and metalloid. It is important to note that Table 5.4 is by no means an exhaustive list.

The most common sulphide mineral is iron sulphide pyrite, which has the formula  $\text{FeS}_2$ . Because it is so common, pyrite has been the most studied sulphide mineral and is assumed to be the source of sulphide in standard ABA calculations (Chapters 12 and 14). Pyrite forms under a wide range of geological and environmental conditions. It can be a primary or secondary mineral and is found in sedimentary rocks and coal beds, base and precious metal deposits, as well as uranium and diamond mines.

Another common iron sulphide mineral at metal mines is pyrrhotite ( $\text{Fe}_{(0.83-1)}\text{S}$ ). Pyrrhotite occurs in basic igneous rocks and is found in sedimentary exhalative massive sulphide deposits and is associated with pentlandite and chalcopyrite in Cu-Ni deposits at the base of mafic intrusions.

**Table 5.4 Formulae for some common sulphide and sulphosalt minerals.**

<b>M<sub>2</sub>S</b>		Chalcocite	Cu <sub>2</sub> S
<b>M<sub>3</sub>S<sub>2</sub></b>		Bornite	Cu <sub>5</sub> FeS <sub>4</sub>
<b>MS</b>		Pyrrhotite	Fe <sub>(0.83-1)</sub> S
Chalcopyrite	CuFeS <sub>2</sub>	Enargite	Cu <sub>3</sub> AsS <sub>4</sub>
Covellite	CuS	Galena	PbS
Sphalerite	(Zn,Fe <sup>2+</sup> )S	Cinnabar	HgS
Realgar	As <sub>4</sub> S <sub>4</sub>	Tetrahedrite	(Cu,Fe,Ag,Zn) <sub>12</sub> Sb <sub>4</sub> S <sub>13</sub>
Tennantite	(Cu,Ag) <sub>10</sub> (Fe,Zn) <sub>2</sub> As <sub>4</sub> S <sub>13</sub>	Pentlandite	(Ni,Fe) <sub>9</sub> S <sub>8</sub>
Cobalt-Pentlandite	(Co,Ni,Fe) <sub>9</sub> S <sub>8</sub>		
<b>M<sub>2</sub>S<sub>3</sub></b>		Orpiment	As <sub>2</sub> S <sub>3</sub>
Stibnite	Sb <sub>2</sub> S <sub>3</sub>	Bismuthinite	Bi <sub>2</sub> S <sub>3</sub>
<b>MS<sub>2</sub></b>		Pyrite	FeS <sub>2</sub>
Marcasite	FeS <sub>2</sub>	Arsenopyrite	FeAsS
Molybdenite	MoS <sub>2</sub>		

The iron sulphide marcasite (FeS<sub>2</sub>) has the same formula as pyrite, but has an orthorhombic instead of isometric structure. Marcasite forms under low temperature and near-surface conditions, but from more acidic solutions than pyrite and is found in zones of supergene enrichment and in clay, shale and coal beds.

Elements released during sulphide mineral oxidation into drainage may derive from the major constituents, minor elements or trace impurities of the weathering sulphide. Common trace elements that form sulphides under low redox conditions include: Ag, As, Cd, Co, Cu, Hg, Mo, Ni, Pb, Sb, Sb and Zn. Common metals that do not form sulphides under the same conditions are: Al, Ba, Cr, Mn and Sr.

The most common sulphide mineral in which Pb is a major constituent is galena (PbS). For Mo, it is molybdenite (MoS<sub>2</sub>) and for Zn, it is sphalerite (Zn,Fe<sup>2+</sup>)S. The most common Ni sulphide is pentlandite (Ni,Fe)<sub>9</sub>S<sub>8</sub>. The most common iron arsenic sulphide mineral is arsenopyrite (FeAsS).

Common Cu sulphide minerals include chalcocite (Cu<sub>2</sub>S), bornite (Cu<sub>5</sub>FeS<sub>4</sub>), chalcopyrite (CuFeS<sub>2</sub>), enargite (Cu<sub>3</sub>AsS<sub>4</sub>), covellite (CuS), tetrahedrite [(Cu,Fe,Ag,Zn)<sub>12</sub>Sb<sub>4</sub>S<sub>13</sub>] and tennantite [(Cu,Ag)<sub>10</sub>(Fe,Zn)<sub>2</sub>As<sub>4</sub>S<sub>13</sub>], of which chalcopyrite is the most abundant. Tetrahedrite is also widespread and is the most common copper sulphosalt. Chalcocite and covellite are primarily formed by supergene enrichment of copper released from the alteration of other copper sulphide minerals.

Mined rock and processed tailings, especially at metal mines, often contain detectable amounts of several sulphide minerals (e.g. Table 5.5). Diagnostic features for visual identification of sulphide minerals include crystal form, cleavage, colour, luster and streak.

**Table 5.5 Sulphide mineral contents of different tailings  
(adapted from Blowes et al., 2003).**

Mine	Copper Cliff	Campbell	Delnite	Heath Steele	Kidd Creek	Nickel Rim	Waite*	Nordic
Ore Type	Ni-Cu	Au	Au	Zn-Pb-Cu	Cu-Zn	Ni-Cu	Zn-Cu-Pb	U
silicate	93%	-	75%	10%	75-85%	90-95%	60%	90%
sulphide	6%	1.5%	5%	85%	15-25%	5-10%	30-40%	5%
carbonate	<1%	-	20%	<2%	1-5%	0.2%	<5%	<0.1%
arsenopyrite	-	present	<1%	-	-	-	-	-
chalcopyrite	<0.5%	traces	-	2%	0.5%	<0.5%	4 <sup>th</sup>	0.07%
galena	-	-	-	1%	0.05%	-	-	0.1%
marcasite	-	-	-	-	-	<0.5%	-	-
pentlandite	<0.5%	-	-	-	-	<0.5%	-	-
pyrite	<0.5%	present	3-5%	70%	18.6%	0.6%	1 <sup>st</sup>	4.9%
pyrrhotite	6%	1.40%	1%	5%	1-2%	9%	2 <sup>nd</sup>	-
sphalerite	-	present	-	3%	1.3%	-	3 <sup>rd</sup>	0.03%

\*In the Waite Amulet tailings, the sulphides are ranked according to their abundance.

The concentration of different sulphide minerals may not provide enough information about potential contaminants and their mineral source where the sulphides are solid solutions or contain considerable trace constituents or impurities. Sphalerite, pentlandite and tetrahedrite are examples of common sulphide minerals that are solid solutions with considerable variability in the chemical species forming the major constituents.

Trace constituents or impurities in sulphide minerals may represent a major portion of the total concentration of many trace elements in a rock and a major source of them in solution. Trace element impurities may occur as a substituted component in the mineral lattice or as microscopic intergrowths or with inclusions in other minerals.

Abraitis et al. (2004) reported the maximum and minimum detectable concentrations of minor and trace element impurities in pyrite. The maximum reported values were 9.6 wt% As, 2.2 wt% Co, 0.7 wt% Sb, 0.3 wt% Au and 0.2 wt% Ni. Copper, Ag and Sn may also occur as minor elements in the pyrite lattice, but are more commonly present within mineral inclusions. The presence of As distorts the pyrite lattice and leads to the incorporation of trivalent metals and other less compatible trace elements. The presence of As in pyrite is often strongly correlated with the content of other trace elements, which may include: Ag, Bi, Cd, Hg, Mo, Pb, Pd, Pt, Ru, Sb, Se, Te, Tl, and Zn. Lead and Zn in pyrite primarily occur in the form of inclusions of



galena and sphalerite, giving Pb and Zn contents of up to 0.9 wt%. Zones with different stoichiometric deviations and trace element impurities may occur within a single pyrite grain.

Similar to pyrite, chalcopyrite may contain minor to trace amounts of many elements such as: Ag, Au, Pt, Pb, Co, Ni, Mn, Sn and Zn replacing Cu or Fe, and As or Se replacing S. Common impurities in pyrrhotite include: Ni, Co, Mn and Cu. Impurities in other sulphide minerals include: Mn and Cd in sphalerite, Co in arsenopyrite and Bi, Sb and Ag in galena. Sphalerite is typically the principal source of Cd, although Cd is generally < 1 wt% (Jambor et al., 2005). Gold may be found in pyrite as intergrowths. Accurate measurement of the chemical composition of different minerals using procedures such as electron microprobe analysis (Chapter 17), may be required to assess metal leaching where solid solution or trace constituents can significantly impact the rate of oxidation and the resulting drainage chemistry.

Differences in the chemical composition and physical properties of sulphide minerals may significantly impact the rate of oxidation and the resulting drainage chemistry. Properties that increase the rate of sulphide oxidation include an increased surface area, structural deformities and a change in balance resulting from chemical impurities. The ability to measure these properties and the understanding of their cumulative impact on oxidation rates are limited. Therefore, oxidation rates should be predicted using tests conducted on specific geologic materials from a site (Chapters 9, 18 and 19).

*Differences in the chemical composition and physical properties of sulphide minerals may significantly impact the rate of oxidation and the resulting drainage chemistry.*

Most sulphide minerals are relatively insoluble. However, oxidation, producing compounds such as sulphates, carbonates and hydroxides, have solubilities sufficiently high to produce environmentally significant concentrations of solutes in the drainage. Possible exceptions include the arsenic sulphides orpiment ( $\text{As}_2\text{S}_3$ ) and realgar ( $\text{As}_4\text{S}_4$ ), and the antimony sulphide stibnite ( $\text{Sb}_2\text{S}_3$ ).

### 5.3.2 Dissolved Sulphur

Sulphide oxidation in excavated and exposed sulphidic geologic materials will result in elevated concentrations of aqueous sulphate in drainage. However, elevated sulphate may also result from the dissolution of sulphate minerals produced by other geological processes and sulphide oxidation in bedrock prior to excavation.

Sulphate is the stable chemical form of dissolved sulphur over most of the ranges in drainage redox potential and pH. Hydrogen sulphide and bisulphide are the stable forms of dissolved sulphur under highly reducing conditions. Bisulphate ( $\text{HSO}_4^-$ ) is the stable form of dissolved sulphur under more oxidizing, low pH conditions, accounting for approximately 10% of the total sulphate at pH 3.0 and predominating below pH 2.

The concentration of sulphate in solution will depend on the solubility limit of sulphate minerals formed from the major cations (Czerewko et al., 2003). The solubility limit for calcium sulphate is relatively low, often giving  $\text{SO}_4^{2-} < 1.4$  g/L. The solubility limits for sodium and magnesium sulphates are much higher, giving maximum  $\text{SO}_4^{2-}$  concentrations of approximately 240 g/L and

180 g/L, respectively. Thus, a lack of calcium and dominance of sodium and magnesium will greatly increase the concentration of dissolved sulphate.

### 5.3.3 Sulphate Minerals

Sulphate minerals can play an important role in drainage chemistry both as a sink and a source of major cations, acidity and potentially harmful trace elements, in addition to sulphate itself. The concentration and composition of sulphate minerals will depend on the initial sulphate mineralogy in a geologic material and sulphate mineral precipitation and dissolution after project development. Prior to excavation, sulphate mineral precipitation and dissolution can result from:

*Sulphate minerals can play an important role in drainage chemistry as a sink and a source of major cations, in addition to sulphate itself.*

- hydrothermal alteration;
- evaporative or marine conditions during deposit formation; and
- bedrock oxidation and leaching.

After excavation, sulphate mineral dissolution and precipitation will depend on the:

- rates of sulphide oxidation and other weathering reactions;
- concentrations of dissolved sulphate and other chemical species; and
- solubility products of sulphate minerals.

Sulphate minerals may also be produced by sulphide oxidation during ore processing and sample storage.

The dissolution of sulphate minerals produced by pre-excavation geological processes, oxidation during ore processing and sample storage may result in elevated solute concentrations in the initial drainage from mine wastes and kinetic tests (e.g. humidity cell leachate, Chapters 18 and 19). Prior identification and measurement of the sulphate minerals are required to determine whether chemical species, such as sulphate, in the initial drainage from mine wastes and kinetic tests come from active sulphide oxidation or dissolution of pre-existing sulphate minerals.

The reaction between products of sulphide oxidation and other minerals will play a large role in determining dissolved cation concentration and thus the type of sulphate minerals that will precipitate when they become supersaturated. An acidic pH may result in the precipitation of Fe, Al and trace metal sulphates. Acid neutralization by calcite or lime increasing the concentration of dissolved calcium may result in the precipitation of gypsum.

Common cations in sulphate minerals include alkaline earth metals like magnesium, calcium, strontium and barium, major metals like aluminum and iron, and trace elements such as lead and zinc (Table 5.6). Sulphate mineral composition is often complex and differences in composition can greatly alter a mineral's solubility.

Other chemical differences among sulphate minerals include: basic vs. acidic ions; hydrated vs. anhydrous; hydroxyl-containing vs. hydroxyl-free; and for iron sulphates, ferrous versus ferric iron.

**Table 5.6 Examples of common sulphate minerals associated with sulphidic geologic materials.**

<b>Anhydrous sulphates (<math>ASO_4</math>)</b>
<ul style="list-style-type: none"> <li>• anhydrite (<math>CaSO_4</math>)</li> <li>• barite (<math>BaSO_4</math>)</li> <li>• celestite (<math>SrSO_4</math>)</li> <li>• anglesite (<math>PbSO_4</math>)</li> </ul>
<b>Highly Soluble, Hydrated Sulphates (<math>ASO_4 \cdot bH_2O</math>)</b>
<ul style="list-style-type: none"> <li>• gypsum (<math>CaSO_4 \cdot 2H_2O</math>)</li> <li>• melanterite (<math>FeSO_4 \cdot 7H_2O</math>)</li> <li>• rozenite <math>FeSO_4 \cdot 4H_2O</math></li> <li>• szomolnokite <math>FeSO_4 \cdot H_2O</math></li> <li>• romerite <math>Fe^{2+}(Fe^{3+})_2(SO_4)_4 \cdot 14H_2O</math></li> <li>• copiapite <math>Fe^{2+}(Fe^{3+})_4(SO_4)_6(OH)_2 \cdot 20H_2O</math></li> <li>• coquimbite <math>(Fe^{3+})_2(SO_4)_3 \cdot 9H_2O</math></li> <li>• aluminite <math>Al_2(SO_4)(OH)_4 \cdot 7H_2O</math></li> <li>• alunogen <math>Al_2(SO_4)_3 \cdot 17H_2O</math></li> <li>• alum <math>KAl(SO_4)_2 \cdot 12H_2O</math></li> <li>• epsomite <math>MgSO_4 \cdot 7H_2O</math></li> </ul>
<b>Lower Solubility, Hydroxy Sulphates [<math>A_b(SO_4)_c(OH)_d</math>] with or without water of crystallization</b>
<ul style="list-style-type: none"> <li>• jarosite [<math>KFe_3(SO_4)_2(OH)_6</math>]</li> <li>• alunite [<math>KAl_3(SO_4)_2(OH)_6</math>]</li> <li>• fibbroferrie [<math>Fe^{3+}(SO_4)(OH) \cdot 5H_2O</math>]</li> <li>• schwertmannite [<math>Fe_8O_8(OH)_6SO_4</math>]</li> <li>• basaluminite [<math>Al_4SO_4(OH)_{10} \cdot 5H_2O</math>]</li> </ul>

Sulphate minerals vary widely in their solubility, ranging from very low solubility minerals such as barite, to highly soluble ones capable of making important contributions to drainage chemistry like soluble sulphate minerals. The solubility of a sulphate mineral affects both its stability in the field and the analytical methods used for its measurement. Under oxidizing conditions:

- anglesite ( $PbSO_4$ ) and barite ( $BaSO_4$ ) have extremely low solubility;
- anhydrite ( $CaSO_4$ ) and gypsum ( $CaSO_4 \cdot 2H_2O$ ) are moderately soluble; and
- hydrated iron sulphates such as melanterite ( $FeSO_4 \cdot 7H_2O$ ) and sodium and magnesium sulphates have high solubility.

Examples of sulphate minerals with slower reaction rates of dissolution and precipitation include members of the alunite-jarosite group.

Solubility products and drainage chemistry will determine the maximum dissolved free ion concentrations of pertinent chemical species upon dissolution of sulphate minerals. For example, precipitation and dissolution of melanterite ( $FeSO_4 \cdot 7H_2O$ ), gypsum ( $CaSO_4 \cdot 2H_2O$ ), anglesite ( $PbSO_4$ ) and barite ( $BaSO_4$ ) may control pore water concentrations of  $Fe^{2+}$ ,  $Ca^{2+}$ ,  $Pb^{2+}$  and  $Ba^{2+}$ , respectively (Alpers et al., 1994). The precipitation and dissolution of minor or trace impurities in sulphate minerals may be an important sink or source for potentially toxic trace elements. For

example, the melanterite pictured in Figure 5.3 contained 1.2% Cu, 2.4% Zn and 0.14% Al, in addition to 23% Fe and 14.2% S.



**Figure 5.3 Melanterite precipitated along a seepage path.**

#### 5.3.3.1 Calcium Sulphate Minerals

The two most common sulphate minerals, both pre-existing and following sulphide oxidation, are the calcium sulphates, anhydrite ( $\text{CaSO}_4$ ) and gypsum ( $\text{CaSO}_4 \cdot 2\text{H}_2\text{O}$ ). Anhydrite is a common alteration mineral found in potassic, sericitic and advanced argillic alteration zones, and in deposits influenced by seawater and aerobic weathering. Gypsum is widely distributed in sedimentary rocks and may form by hydration of anhydrite and precipitation from drainage containing elevated concentrations of sulphate and calcium. Anhydrite and gypsum may be removed from the uppermost leached portions and re-precipitated deeper in a deposit. The reasons for the widespread occurrence of gypsum include:

- relatively high concentrations of dissolved calcium commonly occur in water draining sulphidic geologic materials; and
- low solubility of gypsum compared to sulphates of other major elements such as magnesium, potassium and sodium.

The sources of elevated calcium needed to precipitate calcium sulphate in excavated or exposed sulphidic geologic materials include dissolution of calcium carbonate, hydrolysis of reactive calcium silicates and lime additions during processing. Acidity produced by sulphide oxidation will accelerate the dissolution of calcium carbonate minerals and hydrolysis of calcium silicates.

Gypsum solubility commonly limits the concentration of dissolved sulphate and calcium in a water body. Even at lower pH values where gypsum solubility increases, gypsum often has the lowest solubility product of any major element sulphate mineral. A decrease in the concentration of dissolved calcium will typically lead to an increase in dissolved sulphate.

Dissolution of anhydrite produced by previous hydrothermal alteration or residual gypsum from previous weathering is often responsible for elevated sulphate and calcium in the initial drainage from mine wastes and kinetic tests.

### 5.3.3.2 Iron Sulphate Minerals

Sulphate may precipitate from highly acidic, iron and sulphate rich drainage as iron sulphate minerals. These can be separated into two groups: highly soluble hydrated iron sulphates and less soluble, often anhydrous, ferric iron hydroxysulphate minerals.

*Sulphate may precipitate from highly acidic, iron and sulphate drainage as iron sulphate minerals.*

Hydrated iron sulphate minerals precipitate due to evaporation or other changes in drainage chemistry that increases the solute concentrations or reduces the mineral solubility products (Nordstrom, 1982; Cravotta, 1994). Hydrated iron sulphate minerals generally will rapidly re-dissolve if there is an increase in flow of dilute water through the mine waste (e.g. rain events, snow melt). Due to their high solubility, dissolution of hydrated iron sulphate minerals during flushing events may produce high concentrations of acidity and trace metals.

Hydrated iron sulphate minerals include species that contain ferrous or ferric iron or both of them. Melanterite ( $\text{Fe}^{2+}\text{SO}_4 \cdot 7\text{H}_2\text{O}$ ), is the most common hydrated iron sulphate mineral and often the first to precipitate from the oxidation of pyrite and pyrrhotite. According to Alpers et al., (1994) other common minerals of this hydrated type are:

- ferrous iron sulphates rozenite ( $\text{FeSO}_4 \cdot 4\text{H}_2\text{O}$ ) and szomolnokite ( $\text{FeSO}_4 \cdot \text{H}_2\text{O}$ );
- ferrous and ferric iron sulphates copiapite [ $\text{Fe}^{2+}(\text{Fe}^{3+})_4(\text{SO}_4)_6(\text{OH})_2 \cdot 20\text{H}_2\text{O}$ ] and romerite [ $\text{Fe}^{2+}(\text{Fe}^{3+})_2(\text{SO}_4)_4 \cdot 14\text{H}_2\text{O}$ ]; and,
- ferric iron sulphate coquimbite [ $(\text{Fe}^{3+})_2(\text{SO}_4)_3 \cdot 9\text{H}_2\text{O}$ ].

The formation and subsequent transformations of hydrated iron sulphates will depend on the initial solution composition, degree of oxidation, temperature, humidity and pH (Petruk, 2000).

Field and laboratory studies indicate that increasing oxidation, dehydration and neutralization will alter the hydrated ferrous iron sulphate minerals through a sequence of transformations that reduce the ratios of  $\text{Fe}^{2+}/\text{Fe}^{3+}$ ,  $\text{H}_2\text{O}/\text{Fe}$  and  $\text{SO}_4/\text{OH}$ , respectively (Jerz and Rimstidt, 2004). Decreasing the moisture content or increasing the temperature or acidity will result in the dehydration of  $\text{Fe}^{2+}\text{SO}_4 \cdot n\text{H}_2\text{O}$ , reducing the number of waters of crystallization,  $n$ , from 7 to 1. For example, with increasing temperature and evaporation, melanterite may dehydrate to form species such as rozenite ( $\text{Fe}^{2+}\text{SO}_4 \cdot 4\text{H}_2\text{O}$ ). Increasing oxidation, dehydration and neutralization may convert it into species such as copiapite [ $\text{Fe}^{2+}(\text{Fe}^{3+})_4(\text{SO}_4)_6(\text{OH})_2 \cdot 20\text{H}_2\text{O}$ ]. Oxidation, dehydration and neutralization of hydrated iron sulphate minerals will eventually lead to the

precipitation of iron hydroxysulphate and oxyhydroxide minerals such as jarosite and goethite, respectively (Nordstrom, 1982).

Ferric hydroxysulphate minerals are less soluble than hydrated ferrous sulphate minerals. Examples of ferric hydroxysulphate minerals include fibroferrie [ $\text{Fe}^{3+}(\text{SO}_4)(\text{OH})\cdot 5\text{H}_2\text{O}$ ], schwertmannite [ $\text{Fe}_8\text{O}_8(\text{OH})_6\text{SO}_4$ ] and the different members of the jarosite group with a general formula,  $\text{AFe}_3(\text{SO}_4)_2(\text{OH})_6$ , where the A site may be filled by K, Na,  $\text{H}_3\text{O}$ ,  $\text{NH}_4$ , Ag or  $\frac{1}{2}$  Pb. Ferric hydroxysulphate minerals, such as jarosite, are usually secondary minerals formed in a weathering environment. They are much less common than aluminum hydroxysulphate minerals, such as alunite, in precipitates from hydrothermal solutions associated with hot springs, and volcanic vents.

Divalent ions such as Cu, Mg, Mn, Ni, Pb and Zn and the trivalent ion Al are commonly incorporated as solid solution impurities in iron sulphate minerals. These impurities can affect the order in which various iron sulphates are formed and conversely, the order of formation will alter the concentration of substituting cations (Jambor et al., 2000) in the sulphates.

#### 5.3.3.3 Aluminum Sulphate Minerals

Sulphate may also precipitate from acidic drainage as relatively soluble hydrated aluminum

*Sulphate may precipitate from acidic drainage as soluble hydrated aluminum sulphate minerals and less soluble minerals.*

sulphate minerals, such as alunogen [ $\text{Al}_2(\text{SO}_4)_3\cdot 17\text{H}_2\text{O}$ ], and less soluble minerals, such as alunite with a general formula  $\text{BAI}_3(\text{SO}_4)_2(\text{OH})_6$ , where the B site may be filled by K, Na and/or  $\text{NH}_4$ . In addition to its formation by acid sulphate weathering, alunite is a common product of silicic and advanced argillic alteration in geothermal systems with acid-sulphate water around fumaroles where sulphuric acid reacts with alkali feldspar and muscovite. Evaporative concentrations of hydrated aluminum sulphate minerals will also lead to the formation of alunite (Nordstrom, 1982). The most common of the various hydrated aluminum hydroxysulphate minerals that have been identified is basaluminite [ $\text{Al}_4\text{SO}_4(\text{OH})_{10}\cdot 5\text{H}_2\text{O}$ ], a poorly crystalline mineral commonly observed to precipitate in locations where mixing with higher pH water increases the pH of a sulphate rich drainage with a pH of between 4 and 5 to above pH 5.

#### 5.3.3.4 Barite ( $\text{BaSO}_4$ ) and Celestite ( $\text{SrSO}_4$ )

Two relatively common sulphate minerals formed from alkali earth metals are barite ( $\text{BaSO}_4$ ) and celestite ( $\text{SrSO}_4$ ). Barite has an extremely low solubility even under highly acidic conditions and is found in a wide range of deposit types. Celestite is more soluble and less common than barite. Although a solid solution may exist between  $\text{BaSO}_4$  and  $\text{SrSO}_4$ , most minerals are distinctly Ba or Sr rich (Hanor, 2000). Barite and celestite sometimes occur as a replacement of anhydrite and gypsum.

Although barite and celestite are less soluble than gypsum, concentrations of Ba and Sr in most drainage are typically too low for these minerals to control sulphate concentration. Barite is highly resistant to weathering due to its extremely low solubility. Both barite and celestite may

be destroyed by the reduction of sulphate to hydrogen sulphide. However, the stability field of barite extends into the low redox region where sulphide minerals and reduced sulphur species rather than sulphate are stable.

Radium is also an alkaline earth metal and co-precipitation by barite and celestite provides an important mechanism for the attenuation of dissolved radium in the wastes from uranium mining (Alpers et al., 1994). Reductive dissolution of barite in flooded uranium tailings colonized by aquatic vegetation can release radium into the overlying water cover.

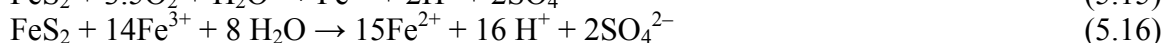
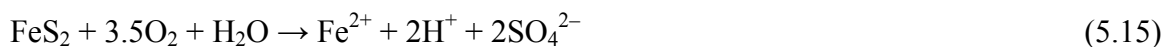
### 5.3.3.5 Other Sulphate Minerals

Sulphate minerals may form from trace elements such as Cu, Mg, Mn, Ni, Pb and Zn (Jambor et al., 2000). The anhydrous sulphate mineral anglesite ( $\text{PbSO}_4$ ) has an extremely low solubility over a wide range in pH conditions and is a common product of oxidation of galena. With the exception of sparingly soluble species such as barite, celestite and anglesite, sulphate minerals with trace elements as a major constituent, typically only occur where there are relatively low concentrations of dissolved iron (Alpers et al. 1994).

## 5.4 Sulphide Oxidation

### 5.4.1 Different Aspects of the Sulphide Oxidation Reaction

Sulphide oxidation may release contaminants and acidity into solution, produce heat and consume oxidants. Sulphide oxidation occurs when sulphide minerals are exposed to water and a dissolved oxidant. The mechanisms, reactants, products and steps involved in sulphide oxidation have been reviewed in a number of publications (Rimstidt and Vaughan, 2003; Nicholson, 1994). Based on pyrite, the most common sulphide mineral, the overall reaction components and products of oxidation by oxygen and ferric iron are shown in Reactions 5.15 and 5.16.



These reactions are simplistic since they include many assumptions about the surrounding environmental conditions and local geochemistry, as explained below.

Sulphide oxidation consists of anodic and cathodic reactions. The anodic part of the sulphide oxidation reaction is the loss of electrons from sulphide-sulphur, giving rise to sulphate-sulphur. Sulphide oxidation removes seven electrons from disulphide and eight electrons from sulphide-sulphur. Research suggests that almost all the sulphur is oxidized to sulphate and almost all the sulphur remains on the mineral surface during this stage of oxidation (Rimstidt and Vaughan, 2003). The only observations of the production of non-sulphate-sulphur are the low concentrations of intermediary partial sulphide oxidation products (e.g. sulphite and thiosulphate) detected when pH exceeds 7 (Moses et al., 1987). There may be some delay in the oxidation of intermediary, partial oxidation products species at lower temperatures (Section 7.6.2).

During sulphide oxidation to sulphate, the concentration of metal cations is reduced. A substantial reduction may occur at mineral surfaces in minerals where metal cations have a high mobility, such as copper in copper-iron sulphides or iron in pyrrhotite. However, in most sulphides, the depletion of metal cations during oxidation is limited to a thin layer at the surface.

The cathodic reaction is an aqueous process in which a dissolved oxidant accepts electrons from a metal cation (e.g. Fe[II]) on the mineral surface. The cathodic reaction is the rate determining step in sulphide oxidation (Rimstidt and Vaughan, 2003).

Potential oxidants include oxygen, ferric iron ( $\text{Fe}^{3+}$ ), nitrate ( $\text{NO}_3$ ) and peroxide ( $\text{H}_2\text{O}_2$ ). The type and rate of supply of the oxidizing agent will depend on the drainage chemistry, especially the pH and redox potential. Ferric iron is relatively insoluble and oxygen is the dominant oxidant above pH 3.0 to 3.5 (Figure 5.4). The rate of pyrite oxidation by oxygen decreases slightly as pH decreases, but below pH 3.5, the concentration of dissolved ferric iron greatly exceeds that of oxygen, increasing the overall oxidation rate and ferric iron becomes the most important oxidant.

Below pH 3.5, bacterial oxidation of ferrous iron to ferric iron becomes a rate limiting step in sulphide oxidation (Singer and Stumm, 1970). However, it is important to note that the oxygen supply may limit the rate of bacterial oxidation of ferrous iron to ferric iron.

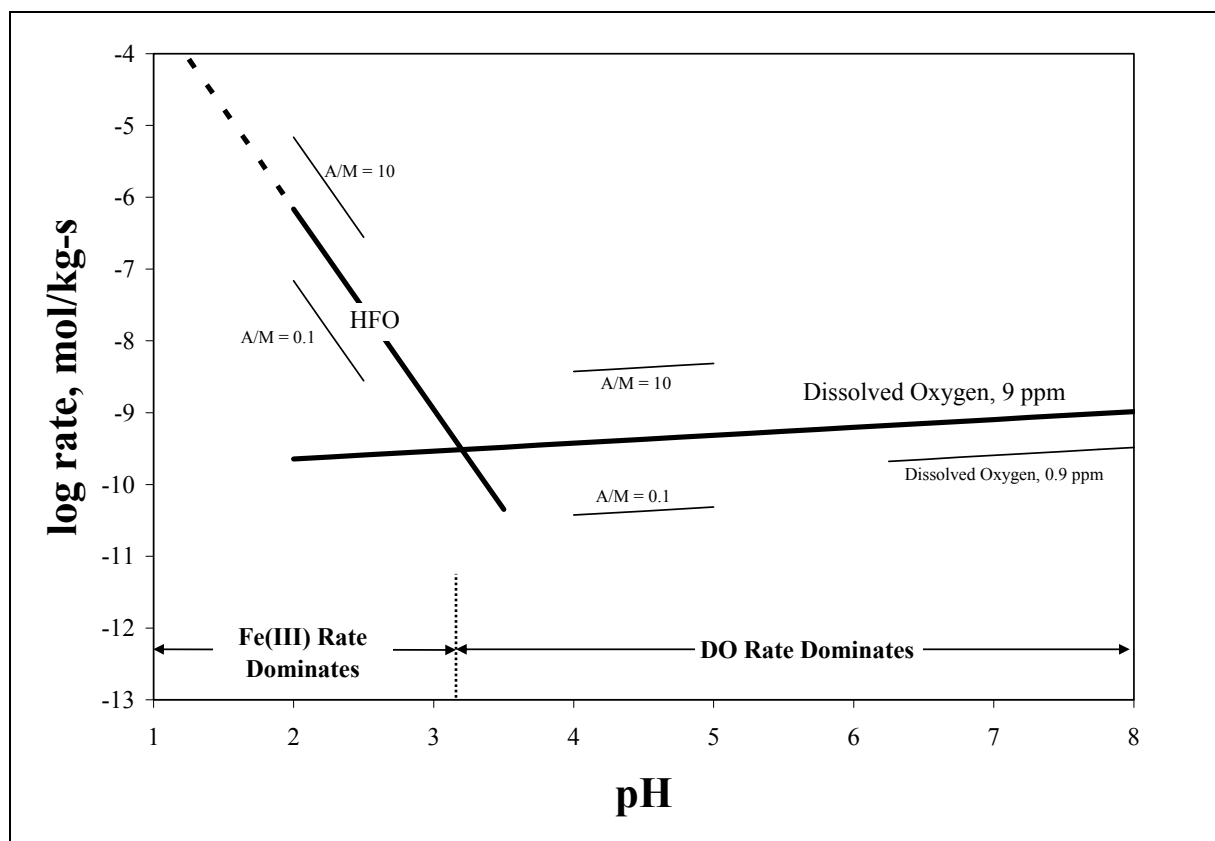
*Below pH 3.5, bacterial oxidation of ferrous iron to ferric iron becomes a rate limiting step in sulphide oxidation.*

The results depicted in Figure 5.4 are for a well mixed system “containing 1 kg of AMD solution containing 250 mg/kg of  $\text{Fe}^{+2}$ , a  $\text{Fe}^{+3}$  concentration buffered by equilibrium with hydrous ferric oxyhydroxide (HFO;  $\text{pK}_{\text{sp}} = 4.89$ ), and approximately 9 mg/kg dissolved  $\text{O}_2$  (air saturation) in contact with 1  $\text{m}^2$  of pyrite. This reference model of 1  $\text{m}^2$  pyrite/1 kg of solution is equivalent to a coarse sand (1.7 mm diameter) containing 10% pyrite, or a fine sand (0.17 mm) containing 1% pyrite and assumes that the pyrite grains are not occluded from contact with solution by either a coating or by trapping inside other minerals” (Williamson et al., 2006).

A/M, the surface area to mass ratio, has been provided “to illustrate the effect of reactive mineral surface area on the rates for both the DO and  $\text{Fe}^{+3}$  reactions” (Williamson et al., 2006).

Like all models, the data presented in Figure 5.4 is a simplification of a complex reality. The lower field reaction rates compared to those observed in kinetic tests, such as a humidity cell, are due to the fact that natural systems are more heterogeneous and not well mixed. Micro-sites with a range in pore water pH and lower oxidant supply will have lower oxidation rates than well mixed systems. Variability in mineralogy, oxidant supply, pH, temperature, grain size, amount of pore solution and other parameters make quantitative prediction of sulphide oxidation rates very challenging.





**Figure 5.4 Comparison of the rate of oxidation of pyrite by ferric iron and dissolved oxygen for different ratios of area to mass (m<sup>2</sup>/kg - A/M - from Williamson et al., 2006).**

There has been a lot written about the potential role of microbes in accelerating sulphide oxidation. The consensus is that the primary effect of microbes in sulphide oxidation reaction is to convert ferrous iron (Fe<sup>+2</sup>) to ferric iron (Fe<sup>+3</sup>) under acidic drainage conditions (Nordstrom and Alpers, 1999; Nordstrom, 2003).

The semi-conducting properties of sulphide minerals and the electrochemical nature of the oxidation reaction result in the anodic and cathodic parts of the reaction happening at different sites. Electrons produced by the oxidation of sulphide-sulphur to sulphate-sulphur are transported from the anodic site to the oxidant at a cathodic site. The electrical conductivity of sulphides may vary widely. For example, the conductivity of pyrites varies between 0.02 and 562 (Ω cm)<sup>-1</sup>, with an average value of 48 (Ω cm)<sup>-1</sup> (Abraitis et al., 2004). Much of the variation in conductivity results from deviations in stoichiometry (e.g. sulphur deficiency) and variability in the trace element composition (Section 5.3.1).

The reaction components, reaction products and the rates of sulphide oxidation vary with the following (Rimstidt and Vaughan, 2003):

- composition of the sulphide minerals;
- drainage chemistry and hydraulic and atmospheric conditions;
- type and rate of supply of the oxidizing agent;

- whether the reaction is abiotic or microbially mediated; and
- the microbial activity.

Oxidation rates and different reactivity rankings for sulphide minerals may be a function of a number of variables (Jambor and Blowes, 1994; Plumlee, 1999; Abruaitis et al., 2004) including:

- exposed surface area;
- mineralogy;
- electrochemical properties such as rest potential;
- stoichiometric differences in major constituents;
- crystal morphology and structural defects; and
- trace element impurities.

Depending on the grain size, exposed mineral surface area can vary by many orders of magnitude; it is therefore likely an important factor in sulphide oxidation (Rimstidt and Vaughan, 2003). Surface area may be increased if secondary weathering products crystallizing in fractures wedge sulphide crystals apart (Section 5.7.3).

*Depending on the grain size, exposed mineral surface area can vary by many orders of magnitude, therefore it is a major factor in sulphide oxidation.*

#### 5.4.2 Products of Sulphide Oxidation

The acidity, iron, trace elements and sulphate produced by sulphide oxidation can:

- dissolve as free ions or complexes and remain in solution;
- precipitate as solids;
- react with other sulphide minerals, potentially accelerating their oxidation; and
- react with the drainage, host rock minerals and other weathering products.

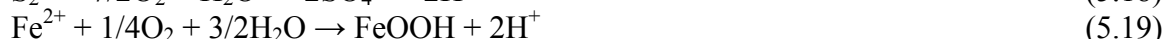
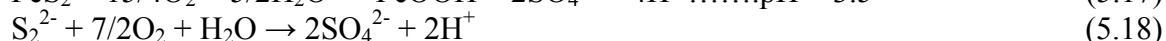
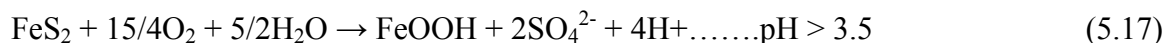
Products from subsequent reactions may augment or alter the drainage and the precipitated solids produced by sulphide oxidation. Reactions with host rock minerals and other drainage may neutralize some or all of the acid (Section 5.6). Acidic flow which is not neutralized will discharge as acid rock drainage. Reactions with host rock minerals and previous reaction products may release other chemical species into solution. Products from the oxidation of sulphide minerals and their reaction with other host rock minerals may dissolve or precipitate as secondary minerals and amorphous coatings.

#### 5.4.3 Products of the Oxidation of Iron Sulphide Minerals

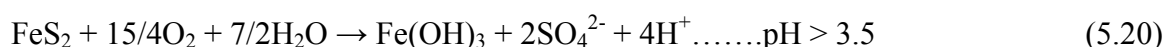
The products of the oxidation of iron sulphide are sulphate, ferrous iron and protons (Reactions 5.15 and 5.16). The mineral phases and soluble chemical species produced after these products are released will depend on the environmental conditions, especially the drainage chemistry. Goethite rather than ferrihydrite ( $\text{Fe}(\text{OH})_3$ ) is the primary ferric oxyhydroxide observed after iron sulphide oxidation takes place at slightly acid or near-neutral pH (Blowes et al., 2003).

*The products of the oxidation of iron sulphide are sulphate, ferrous iron and protons.*

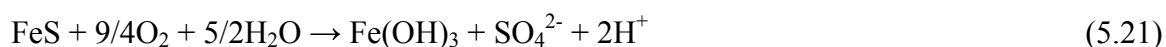
As shown in Reaction 5.17, oxidation of pyrite ( $\text{FeS}_2$ ) with subsequent oxidation and hydrolysis of the released iron at a pH above 3.0 to 3.5 produces a mole of goethite ( $\text{FeOOH}$ ), two moles of sulphate and two moles of acidity per mole of sulphide-S. In this reaction, half of the acidity is generated by the oxidation of the sulphide-S (Reaction 5.18) and the other half comes from the oxidation of ferrous iron ( $\text{Fe}^{2+}$ ) to ferric iron ( $\text{Fe}^{3+}$ ) and its hydrolysis to goethite (Reaction 5.19).



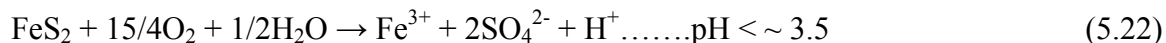
The same amount of acidity is produced per mole of sulphide-S when the iron species resulting from pyrite oxidation is ferrihydrite (Reaction 5.20).



The oxidation reaction for pyrrhotite ( $\text{FeS}$ ) and precipitation of iron as ferrihydrite also produces two moles of  $\text{H}^+$  per mole of sulphide-S as in pyrite ( $\text{FeS}_2$ ) (Reaction 5.21).



Under strongly oxidizing conditions and a pH below 3.0 to 3.5 at which ferrous iron is oxidized to ferric iron but the ferric iron does not hydrolyze to ferric oxyhydroxide, the oxidation of pyrite will produce one mole of  $\text{H}^+$  and 3 moles of  $\text{Fe}^{3+}$  (Reaction 5.22).



A notable difference between the oxidation of pyrite and pyrrhotite is that when the pH is less than 3.0 to 3.5 and there is no iron hydrolysis, pyrrhotite oxidation consumes rather than generates hydrogen ions and the reaction may therefore increase the pH (Reaction 5.23).



Kwong and Ferguson (1997) reported that the relative reactivity of different iron sulphide minerals was marcasite > pyrrhotite > pyrite. Rimstidt and Vaughan (2003) concluded that the higher rate of oxidation of marcasite compared to pyrite is largely attributable to a higher surface area. Framboidal pyrite, with a high surface area, oxidizes much more rapidly than euhedral pyrite (Pugh et al., 1984; White and Jeffers, 1994).

An important feature of iron sulphide oxidation at a pH < 3.5 is that ferric iron ( $\text{Fe}^{3+}$ ) generated by the oxidation of ferrous iron can serve as the sulphide oxidizing agent (Reaction 5.23). Leaching of ferric iron may oxidize sulphide minerals below the depth of oxygen penetration.

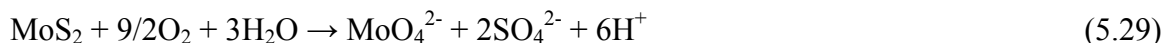
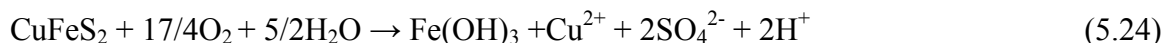
#### 5.4.4 Products of Oxidation of Trace Element Sulphide Minerals

Oxidation reactions at pH > 3.5 for some of the more common sulphide minerals in which trace elements are a major component (chalcopyrite ( $\text{CuFeS}_2$ ), covellite ( $\text{CuS}$ ), galena ( $\text{PbS}$ ),

sphalerite (ZnS), chalcocite (Cu<sub>2</sub>S), molybdenum (MoS<sub>2</sub>) and arsenopyrite (FeAsS) are shown below (Reactions 5.24 to 5.30).

Trace metals and metalloids released from sulphide minerals may:

- dissolve either as free ions or complexes;
- precipitate as sulphates, oxides, hydroxides, or carbonates;
- be chelated by organic acids;
- adsorb on the surfaces of materials such as iron oxyhydroxides; or
- co-precipitate with other solid phases.



The difference in acid (H<sup>+</sup>) produced per mole of sulphide-S for oxidation reactions in which trace metals and metalloids become dissolved cations or oxyanions may be important because, unlike ferric iron, many trace metals and metalloids are relatively soluble under slightly acid and near-neutral pH conditions. Circumneutral drainage can contain relatively high dissolved concentrations of trace elements such as nickel, cobalt, zinc, molybdenum, arsenic, and antimony. Concentrations of molybdenum, arsenic, and antimony in particular may remain elevated even as pH increases above 7.

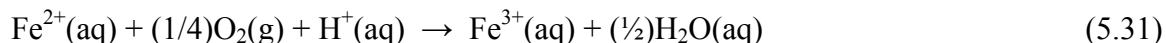
Studies conducted at a number of tailings impoundments indicate that the general order of sulphide mineral depletion is as follows: pyrrhotite > galena > sphalerite > bornite > pentlandite > arsenopyrite > marcasite > pyrite > chalcopyrite > molybdenite (Jambor et al., 2005). As stated previously, differences in the rate of oxidation may be due to differences in surface exposure and site specific structural and chemical differences (Section 5.4.1). Studies have shown that fine grained pyrite weathers twice as fast as coarse granular pyrite (Kwong, 1993 and 1996). Kwong and Lawrence (1994) suggested that Co substituting for Fe might retard the weathering rate of pyrite, while Jambor et al. (2005) noted that an increase in iron content increases the oxidation and dissolution rate of sphalerite.

The formation of rims of secondary minerals with low solubility may slow the rate of sulphide oxidation. Iron oxyhydroxide layers may form around oxidizing iron containing sulphide minerals when the pH is > 3.5, but will not be present at lower pH. Rims of anglesite (PbSO<sub>4</sub>) may form around galena regardless of the pH, causing galena to persist relative to other sulphide minerals.

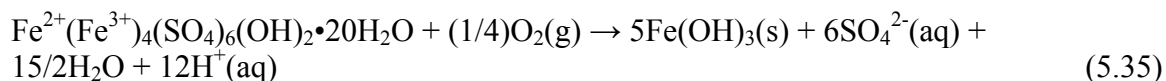
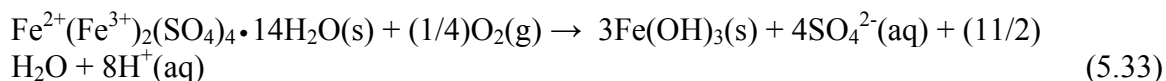
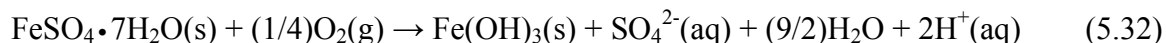
### 5.5 Acidity from Dissolution of Acidic Sulphate Minerals

The dissolution of sulphate minerals may release acidity in the form of acidic cations, such as  $\text{Al}^{3+}$ ,  $\text{Cu}^{2+}$ ,  $\text{Fe}^{2+}$ ,  $\text{Fe}^{3+}$ ,  $\text{H}_3\text{O}^+$ ,  $\text{NH}_4^+$ ,  $\text{Pb}^{2+}$  and  $\text{Zn}^{2+}$ . Formation of dissolved complexes and precipitation of the released acidic cations as oxides, oxyhydroxides, hydroxides or carbonates will convert the dissolved acidity into  $\text{H}^+$  and reduce the pH. Oxidation of reduced cations, without subsequent complex formation or precipitation, will consume protons. The most common occurrence of this is the oxidation of ferrous (II) to ferric (III) iron (e.g. Reaction 5.31).

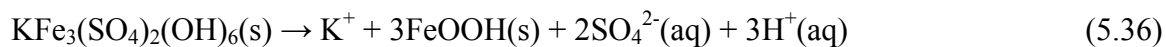
*The dissolution of sulphate minerals may release acidity in the form of acidic cations.*



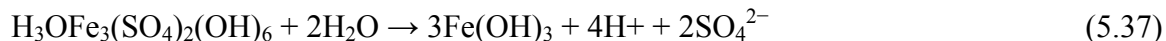
The most common acidic sulphate minerals are the iron and aluminum hydrated and hydroxy sulphates. Under oxidized, near-neutral pH conditions, dissolution of iron and aluminum hydrated and hydroxyl sulphate minerals will also result in the oxidation of ferrous to ferric iron and hydrolysis of the ferric iron and aluminum. Reactions 5.32 to 5.35 show the overall reaction for melanterite ( $\text{FeSO}_4 \cdot 7\text{H}_2\text{O}$ ), romerite [ $\text{Fe}^{2+}(\text{Fe}^{3+})_2(\text{SO}_4)_4 \cdot 14\text{H}_2\text{O}$ ], coquimbite [ $(\text{Fe}^{3+})_2(\text{SO}_4)_3 \cdot 9\text{H}_2\text{O}$ ] and copiapite [ $\text{Fe}^{2+}(\text{Fe}^{3+})_4(\text{SO}_4)_6(\text{OH})_2 \cdot 20\text{H}_2\text{O}$ ] under oxidized, near-neutral pH conditions.



The ferric-hydroxy-sulphate jarosite, which is stable at a  $\text{pH} < 4$  and relatively soluble (but kinetically slow) above about  $\text{pH} 4.7$ , will undergo hydrolysis in moist environments to release the stored acidity (Reaction 5.36).



Jarosite, containing one mole of acidic cations, such as  $\text{H}_3\text{O}^+$ ,  $\text{NH}_4^+$ ,  $\text{Ag}^+$  or  $1/2 \text{Pb}^+$ , rather than potassium will produce two moles of acidity for each mole of sulphate-sulphur dissolved. This is illustrated in the reaction below for hydronium jarosite.



The impact of the dissolution of less soluble iron and aluminum hydroxy-sulphate minerals, such as jarosite or alunite, on drainage pH will depend on the rate of dissolution and hydrolysis. According to Alpers et al. (1994), leach studies showed a drop in the pH of deionized water from 6 to 3 or 4 after contact with natural and synthetic jarosites. There is a wide range in the composition of jarosite minerals and their reactivity is also variable. In communication with Lapakko (in 2005), Alpers speculated that a hydronium jarosite may buffer pH in the range of 1.5 to 3.

### 5.5.1 Displacement of Acidity on Exchange Sites

Upon percolating through the soil, base cations in near-neutral seepage containing high concentrations of sulphate dissolution or sulphide oxidation products can exchange with acidity (e.g.  $H^+$  and  $Al^{3+}$ ) adsorbed on acidic organic or mineral soils (Reaction 5.38). If the soil water has little or no alkalinity, the released  $H^+$  and  $Al^{3+}$  may decrease the drainage pH. This phenomenon is potentially responsible for the acid drainage and decrease in drainage pH observed from non-acid generating waste rock dumps located on top of slightly acidic peat soils (Price, 2005).

*If the soil water has little or no alkalinity, the released  $H^+$  and  $Al^{3+}$  may decrease the drainage pH.*



The impact of cation exchange on drainage pH will depend on the:

- cation and alkalinity concentrations in the leachate from the project components;
- exchangeable acidity of the underlying soils; and
- sensitivity of the downstream drainage pH to inputs of acidity.

### 5.6 Acid Neutralization and Production of Net Acidic Drainage

The rates of sulphide oxidation, acid generation and neutralization, the drainage pH and the time to onset of net acidic drainage are determined by a large number of site specific mining, geological and environmental factors. Oxidized sulphide bearing rock does not always create acidic drainage. In many cases, alkalinity released from other minerals, immediately adjacent or further upstream or downstream to the oxidizing sulphides, may neutralize the acid in the immediate vicinity or downstream of the acid generating sulphide minerals. Acidic drainage will only occur if the rate of acid generation is greater than the rate of neutralization and there is sufficient water to transport the acid weathering products.

Where the rate of neutralization is already slower than that of acid generation, the onset of net acidic weathering conditions and acidic drainage will occur immediately upon mineral exposure and leaching. However, it may take many years before weathering or leaching conditions cross the biological, physical and chemical thresholds necessary to produce net acidic drainage. The observation that acidic drainage has not yet occurred is, on its own, no assurance that it will not occur in the future. It took 10 to 20 years to exhaust the neutralization sufficiently to produce acidic drainage at the Island Copper Mine (Morin and Hutt, 1997). Even under acidic conditions, much of the released chemicals may precipitate as secondary minerals and it may take many years to produce the worst concentrations of acidity and potential toxins.

Acid ( $H^+$ ) produced by sulphide mineral oxidation can be neutralized by a wide variety of reactions. The rate of acid generation and the composition of the neutralizing minerals will determine the extent of neutralization. The three general categories of neutralizing minerals are carbonates, hydroxides and silicates. The dissolution and precipitation of carbonate and hydroxide minerals and the dissolution of silicate minerals determine the resulting drainage pH

*The rate of acid generation and the composition of the neutralizing minerals will determine the extent of neutralization.*

and acidity. The ranges in pH buffering observed after acid neutralization by common carbonate minerals calcite and siderite and aluminum and iron hydroxide minerals are shown in Table 5.7.

**Table 5.7 The pH range resulting from acid-neutralization by common carbonate and hydroxide minerals (from Blowes et al., 2003).**

Mineral Phase	pH Range
Calcite	6.5 – 7.5
Siderite	4.8 – 6.3
Al(OH) <sub>3</sub>	4.0 – 4.3
Fe(OH) <sub>3</sub>	2.5 – 3.5

### 5.6.1 Neutralization by Carbonate Minerals

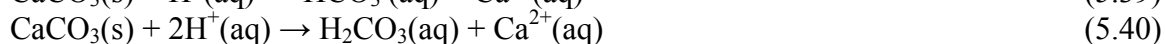
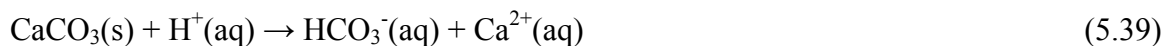
Carbonate minerals consist of the carbonate ion (CO<sub>3</sub><sup>2-</sup>) and various cations. The most common cations in carbonate minerals are Ca, Mg, Fe and Mn. The formula and percent by weight of the main constituents in pure Ca, Mg, Fe and Mn carbonate minerals are shown in Table 5.8. The most common carbonate mineral is the calcium carbonate, calcite. Other common carbonate minerals are dolomite (CaMg[CO<sub>3</sub>]<sub>2</sub>), ankerite (CaFe[CO<sub>3</sub>]<sub>2</sub>) and siderite (FeCO<sub>3</sub>). Trace elements may also form carbonate minerals (e.g. smithsonite (ZnCO<sub>3</sub>)). The copper carbonate hydroxides azurite (Cu<sub>3</sub>[CO<sub>3</sub>]<sub>2</sub>[OH]<sub>2</sub>) and malachite (Cu<sub>2</sub>[CO<sub>3</sub>]<sub>2</sub>[OH]<sub>2</sub>), azure blue and bright green respectively, are two other common examples.

**Table 5.8 The formula and percent by weight of the main components in pure Ca, Mg, Fe and Mn carbonate minerals (taken from Jambor and Blowes, 1994).**

Mineral	Formula	CO <sub>2</sub>	CaO	MgO	FeO	MnO
Calcite	CaCO <sub>3</sub>	43.97	56.03			
Magnesite	MgCO <sub>3</sub>	52.19		47.81		
Siderite	FeCO <sub>3</sub>	37.99			62.01	
Rhodochrosite	MnCO <sub>3</sub>	38.29				61.71
Dolomite	CaMg(CO <sub>3</sub> ) <sub>2</sub>	47.73	30.41	21.86		
Ankerite	CaFe(CO <sub>3</sub> ) <sub>2</sub>	40.76	25.97		33.27	
Magnesium Ankerite	Ca(Mg,Fe)(CO <sub>3</sub> ) <sub>2</sub>	43.97	28.01	10.07	17.95	
Kutnohornite	CaMn(CO <sub>3</sub> ) <sub>2</sub>	40.93	26.08			32.99

Calcium and magnesium carbonate minerals, including calcite (CaCO<sub>3</sub>), magnesite (MgCO<sub>3</sub>), dolomite (CaMg[CO<sub>3</sub>]<sub>2</sub>) and ankerite (CaFe[CO<sub>3</sub>]<sub>2</sub>) are commonly the most effective minerals in neutralizing acid. Reactions 5.39 and 5.40 show the acid-neutralizing reaction for calcite

(CaCO<sub>3</sub>) above and below pH 6.4, respectively (Drever, 1988). Calcite neutralization buffers the pH at 6.5 to 7.5 (Table 5.7).



Of the calcium and magnesium carbonate minerals, calcite dissolves most rapidly (Busenberg and Plummer, 1986). The rate of dolomite dissolution is about an order of magnitude slower than calcite (Busenberg and Plummer, 1982). Ankerite is more resistant to dissolution than dolomite and siderite is even more resistant than ankerite (Jambor and Blowes, 1998). The rate of magnesite dissolution is about four orders of magnitude slower (Chou et al., 1989).

The pH buffering by iron and manganese carbonates depends on the degree of aeration. As shown in Reaction 5.41, the dissolution of FeCO<sub>3</sub> initially consumes acidity in a similar manner to calcite (Reaction 5.40). However, under oxygenated conditions, the subsequent oxidation and hydrolysis of the released iron produces equivalent acidity (Reaction 5.42) to that consumed in Reaction 5.41, so there is no net neutralization under aerobic conditions (Reaction 5.43).



Iron and manganese carbonate, in minerals such as siderite and rhodochrosite, only provide net acid neutralization under anaerobic conditions. The rate of siderite dissolution under anoxic conditions is reported to be three orders of magnitude slower than that of calcite (Greenberg and Tomson, 1992). The anaerobic conditions required for iron and manganese carbonates to provide net neutralization may materialize from the partial flooding or the slow oxygen diffusion and rapid oxygen consumption within fine textured waste materials (e.g. tailings).

The reaction between sulphate derived from sulphide oxidation and calcium from carbonate dissolution may result in the saturation and precipitation of gypsum. Fe(II) produced by iron sulphide oxidation and HCO<sub>3</sub><sup>-</sup> released by calcite dissolution may combine and precipitate as secondary siderite. Following the depletion of more soluble calcium carbonate and magnesium carbonate minerals, the dissolution of primary and secondary siderite can buffer the pH to near 4.8 (Table 5.7).

Many carbonate minerals are solid solutions in which the percentage of Ca, Mg, Fe and Mn components (Klein and Hurlbut, 1993) and their neutralizing potential under aerobic conditions, can vary widely. Calcite tends to be nearly pure, although it potentially contains up to 5 and 2 wt% FeO and MgO, respectively and a complete solid solution series extends to rhodochrosite (MnCO<sub>3</sub>). There are almost complete solid solution series between dolomite, ankerite and kutnahorite, and siderite with magnesite and rhodochrosite.

Electron microprobe analyses of calcite, dolomite, ankerite and siderite grains in the Asitika Group of rock from the Kemess Mine indicate the relative purity of calcite and the presence of significant Fe in dolomite, and Ca+Mg in siderite (Table 5.9). Notably, the median % Ca+Mg



component was 29% in the siderite, providing significant net neutralization, while the median % (Fe+Mn) in the dolomite was only 9%.

The rate of dissolution and precipitation of carbonate minerals is fast relative to the rates of other reactions and pore water movement. Therefore, dissolution and precipitation of carbonate minerals are usually equilibrium controlled. Increases in either the CO<sub>2</sub> pressure or the H<sup>+</sup> concentration will increase the rate at which carbonate minerals dissolve.

**Table 5.9 Electron microprobe analysis of percentage of Ca, Mg, Fe, Mn, Ca+Mg and Fe+Mn CO<sub>3</sub> in calcite, dolomite, ankerite and siderite grains in Asitika Group rock from the Kemess Mine.**

		Calcite	Dolomite	Ankerite	Siderite
%Ca	5 <sup>th</sup> Per	92	50	37	2
	Median	97	56	38	5
	95 <sup>th</sup> Per	99	58	51	11
%Mg	5 <sup>th</sup> Per	0	27	11	17
	Median	0	36	22	25
	95 <sup>th</sup> Per	5	40	29	32
%Fe	5 <sup>th</sup> Per	0	1	32	55
	Median	0	6	37	69
	95 <sup>th</sup> Per	3	16	40	78
%Mn	5 <sup>th</sup> Per	0	1	1	0
	Median	2	2	1	2
	95 <sup>th</sup> Per	3	7	1	6
%Ca+Mg	5 <sup>th</sup> Per	95	81	59	21
	Median	97	91	62	29
	95 <sup>th</sup> Per	99	97	67	42
%Fe+Mn	5 <sup>th</sup> Per	1	3	33	58
	Median	3	9	38	71
	95 <sup>th</sup> Per	5	19	41	79

### 5.6.2 Neutralization by Aluminum and Iron Oxyhydroxides

After the depletion of carbonate minerals, pH buffering reactions are commonly dominated by the dissolution and precipitation of first aluminum and then iron oxyhydroxides (Reactions 5.44 to 5.46).



The dissolution and precipitation of aluminum ions derived from minerals such as gibbsite ( $\text{Al}(\text{OH})_3$ ) buffer the pH between 4.0 and 4.3 (Blowes et al., 2003). Aluminum ions may also be produced by the weathering of aluminosilicate minerals such as the plagioclase-feldspar anorthite ( $\text{CaAl}_2\text{Si}_2\text{O}_8$ ).

The dissolution and precipitation of iron ions derived from minerals, such as goethite ( $\text{FeOOH}$ ) and ferrihydrite ( $\text{Fe}(\text{OH})_3$ ), buffer the pH between 2.5 and 3.5 (Blowes et al., 2003). Iron ions are also produced by the oxidation of iron sulphides and the weathering of other iron containing minerals such as biotite and chlorite.

Although the dissolution of aluminum and iron oxyhydroxides will not maintain near-neutral pH conditions, the consumption of acidity can significantly reduce treatment costs and the trace metal concentrations, though generally not to a level that meets water quality standards.

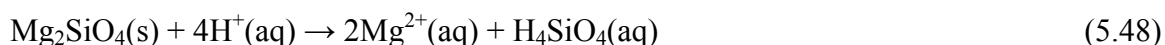
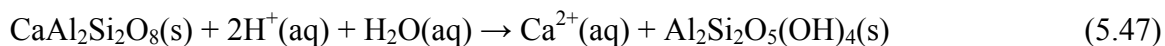
The rate of dissolution and precipitation of aluminum and iron oxyhydroxides is generally fast relative to the rates of other reactions and pore water movement. Therefore, these reactions are usually equilibrium controlled.

When the pH remains above 4.8 due to dissolution of minerals such as siderite and calcite, iron from sulphide oxidation and aluminum from aluminosilicate dissolution will precipitate replacing the weathered grains or as coatings of metal hydroxide and hydroxyl sulphates, such as amorphous  $\text{Fe}(\text{OH})_3$  and  $\text{Al}(\text{OH})_3$ , gibbsite, ferrihydrite, goethite and schwertmannite (Blowes and Ptacek, 1994). In some instances, precipitated metal hydroxide and hydroxyl sulphates may form cemented layers or hard pans.

### 5.6.3 Neutralization by Silicate and Aluminosilicate Minerals

After the depletion of carbonates, iron and aluminum hydroxides, the dissolution of aluminosilicate minerals may become the primary acid neutralization mechanism.

The weathering of silicate and aluminosilicate minerals, such as the plagioclase-feldspar anorthite (Reaction 5.47) and the olivine forsterite (Reaction 5.48), can neutralize acid and is a primary source of Fe and Al ions (Section 5.6.2).



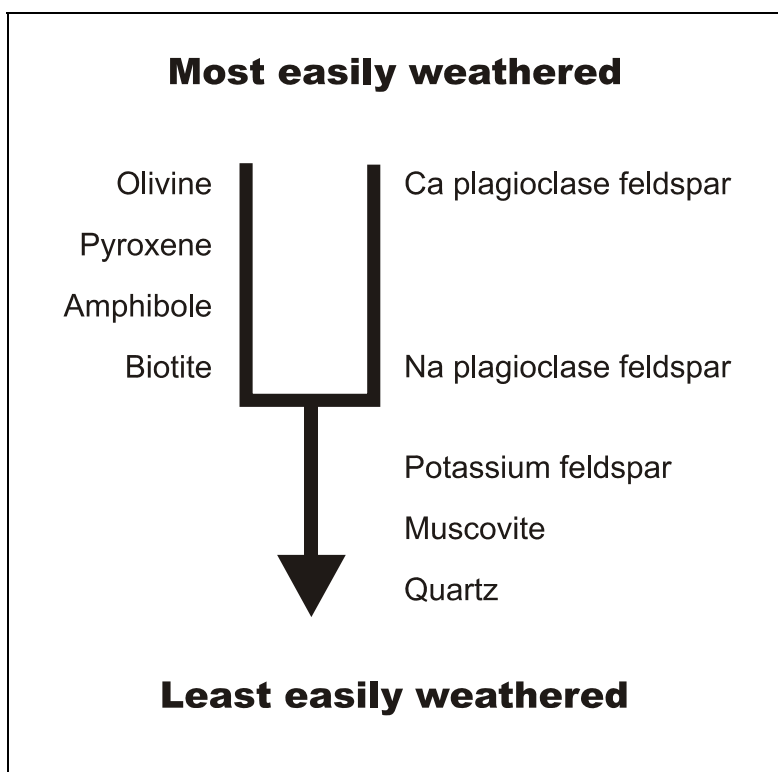
There are a large number of silicate and aluminosilicate minerals, with a wide range of forms, geochemical compositions, weathering rates and susceptibility to different weathering processes. Weathering of silicate and aluminosilicate minerals and the dissolution of the resulting reaction products and secondary minerals will be primarily responsible for the dissolved K, Na, Si and Al, and a portion of the dissolved Fe, Ca and Mg in the drainage.

The rate of silicate and aluminosilicate weathering is slow relative to the rates of other reactions and pore water movement and therefore is usually kinetically limited. Even the rates of acid neutralization by the most reactive silicate and aluminosilicate are much slower than that of

carbonate minerals and are only capable of maintaining near-neutral pH conditions if there is a very slow rate of acid production (e.g. a low iron sulphide concentration) (Lapakko and Antonson 1994; Lapakko et al. 1997; Lapakko and Antonson 2002).

Various attempts have been made to classify the relative reactivity of silicate and aluminosilicate minerals. One of the earliest was the Goldich Stability Series ranking silicate minerals from least to most stable (Figure 5.5) in a weathering environment (Goldich, 1938).

According to Jambor (2003), the rates of weathering of the most reactive silicate minerals, anorthite, olivine and wollastonite, are 200 times slower than that of calcite; those for pyroxenes and amphiboles are 10,000 times slower. Properties which can strongly influence the rate of silicate weathering include flaws in the minerals and surface area. One of the fastest silicate weathering reactions is the leaching of K from the interlayer of phyllosilicate minerals such as biotite (Jambor, 2003).



**Figure 5.5** The Goldich Stability Series ranking silicate minerals from the most to the least weatherable.

## 5.7 Other Properties and Processes that Control Weathering Reaction Rates and Drainage Chemistry

A large number of parameters potentially control weathering reaction rates and the resulting drainage chemistry. A few of these, including surface area, physico-chemical settings, temperature and pH, are discussed below.

### 5.7.1 Size, Surface Area and Arrangement of Particles

The size, surface area and arrangement of particles and the resulting fabric and structure, will affect drainage chemistry through their influence on the following properties and processes:

- mineral surface area;
- pore size distribution and arrangement;
- hydraulic properties and drainage conditions such as hydraulic conductivity, suction, moisture retention, infiltration, flow paths, leaching, discharge and flooding; and
- air permeability, air movement and oxygen supply in a waste deposit.

Mineral surface area is a function of the particle surface area. Pore size distribution and arrangement is a function of the particle size distribution and particle arrangement. Pore size distribution and arrangement, along with drainage and air inputs, in turn determine hydraulic, drainage and atmospheric properties and processes.

Particle surface area is primarily a function of the particle size distribution as a result of the

*Particle surface area is primarily a function of the particle size distribution due to the exponential increase in the surface area per unit mass with a decrease in particle size.*

exponential increase in particle surface area per unit mass with a decrease in particle size (Birkeland, 1974). Other parameters that will increase the particle surface area include particle shape, surface roughness, fractures and lattice defects. Plate-shaped crystals have a greater surface area per unit volume than cube- and sphere-like shaped particles.

The initial particle size distribution, surface area and structure of project components will depend on the following properties and processes:

- particle size and surface area prior to the project (non-lithified surficial materials);
- strength of the geologic materials;
- methods and conditions used to blast, excavate, remove, process, handle, dispose of geologic materials;
- mechanical disturbance such as surface traffic and resloping;
- segregation of different particle sizes during removal from excavations, material handling and deposition; and
- adjacent disposal of materials with a different particle size distribution or spatial arrangement of particles and voids.

Examples of structural features created during disposal and related mechanical disturbances include:

- slimes and sand portions of a tailings impoundment created by gravimetric segregation from a tailings slurry on a tailings beach;

- layers with different particle size distributions parallel to the angle of repose of waste rock dump slopes due to differences in the original particle size distribution and particle size segregation of the waste rock dumped;
- fine particle rich and coarse fragment rich segments of a waste rock dump created by gravimetric segregation after end- or push-dumping waste rock onto the advancing slope of a high waste rock dump;
- layers or bedding with a different particle size distribution created by changing flow paths, spigot locations or the composition of a tailings slurry; and
- traffic surfaces created by vehicle movement on the bench top of a waste rock dump.

Particle size distribution, particle surface area and structure are not static properties. Over time, particles may be:

- fractured, broken, dissolved, precipitated and cemented together by physical and chemical weathering; and
- moved by gravity, drainage and wind erosion.

The rate of reduction in particle size and changes in particle size distribution, particle surface area and structure by weathering and erosion will depend on the:

- physical and geochemical composition of the geologic materials;
- weathering and erosion conditions; and
- duration of exposure.

Particle breakdown may occur through dissolution or disintegration into smaller pieces. Oxidation reaction products may also cause expansion and therefore further fracturing of particles. Dissolution of particles will reduce the particle surface area. Breaking particles into smaller pieces will:

- increase the mineral surface area;
- expose fresh unweathered mineral surfaces; and
- reduce the size of individual particles and pores.

The exposure of fresh unweathered surfaces may:

- change the composition of the fine particle size fraction;
- replenish the supply of reactive minerals; and
- delay mineral depletion.

Changes to the composition of the fine particle size fraction may change the drainage chemistry

*Changes to the composition of the fine particle size fraction may change the drainage chemistry and its timing.*

and its timing predicted from the initial geochemical composition of the fine particles. For example, particle breakdown may replenish the supply of neutralizing minerals such as calcite, maintaining neutral pH drainage for far longer than that predicted from the calcite concentration and rate of depletion initially measured in the reactive fines. Continual exposure of fresh sulphide grains may increase sulphide oxidation rates. Differences in the

relative rates of exposure may alter the ratio of acid generating and neutralizing minerals and the resulting drainage chemistry.

Rapid disintegration into smaller particles may result from high concentrations of minerals that have:

- low cohesion between mineral grains (e.g. clay minerals in sericitic rock);
- high rates of hydration and dissolution (e.g. sulphates and carbonates); or
- high rates of oxidation (e.g. sulphide minerals).

Changes in particle size and strength over time may result in material settlement, which will reduce the height of a deposit and its pore size. Changes to the overall pore volume will depend on the relative amounts of particle dissolution, precipitation of weathering products and settlement. Reductions in pore size may increase the degree of saturation, reduce air movement and increase flooding.

Weathering may also create new particles due to the precipitation of weathering products. Precipitation of weathering products may change the size distribution, particle surface area and arrangement of particles by coating particle surfaces, cementing particles together and creating hard pans. Changes in particle and pore size, settlement, precipitation of weathering products and particle migration may change flow paths, potentially leaching previously relatively unleached portions of a project component and creating new discharge locations.

Parameters that increase the potential for erosion include:

- high wind or water velocity;
- low particle cohesion; and
- small particle size.

Dry fine sand, coarse silt particles and the particle size range of tailings sand have little or no cohesion and are therefore very susceptible to wind erosion. The higher moisture retention and particle cohesion makes tailings slimes less susceptible than tailings sand to wind erosion.

*Dry fine sand, coarse silt particles and the particle size range of tailings are very susceptible to wind erosion.*

There is presently little quantitative information about particle breakage and migration and their impact on the physical, hydrological and geochemical properties of project components. Although future fracturing and breaking of particles may impact drainage chemistry, the rate and impact of these processes are typically not investigated in the prediction of drainage chemistry.

### 5.7.2 Mineral Surface Area

Weathering reactions such as oxidation of sulphide minerals and dissolution of carbonate minerals are surface controlled reactions and therefore the rates of these reactions are dependent on the mineral surface area exposed to weathering. Mineral surface area is a function of:

- mineral grain size;
- fractures, lattice defects and “roughness” of the mineral surface;

- coatings; and
- mineral occurrence on the surface of particles.

Fractures, lattice defects and roughness of the mineral surface will increase the mineral surface area and therefore the reactivity. They may also result in broken bonds and charge imbalances that increase the weathering rates. Coatings, such as iron oxyhydroxides, may reduce the exposure of mineral surfaces to weathering processes, thereby reducing reactivity.

Individual mineral grains may become fine particles and entirely liberated from the rock matrix, interstitial to other minerals (partially liberated) or included within other minerals. The extent that minerals occur on surfaces or within particles whose size is similar to or only slightly larger than their grain size will affect their availability for reaction. Acid producing or acid neutralizing minerals occluded within minerals such as quartz or coarse fragments will be unavailable for reaction until they are exposed by other weathering processes.

The diameter of particles in which almost all the mineral grains are exposed to weathering will depend on the size of the mineral grains. Removal of the carbonate minerals by weathering from the < 2 mm sized particles, but not from the 2 to 11 mm size fraction of various volcanic and intrusive rocks suggested that the < 2 mm fraction was the particle size fraction in which almost all the mineral grains will be exposed to weathering (Price and Kwong, 1997).

*The diameter of particles in which almost all of the mineral grains are exposed to weathering will depend on the size of the mineral grains.*

The residence time for leachate is likely to be longer in a matrix of small particles resulting in greater dissolution of weathering products. There are likely to be more broken chemical bonds that increase the rate of weathering in smaller particles.

The increased rate of oxidation and dissolution of weathering products resulting from an increase in mineral surface area will depend on the maintenance of an adequate oxygen supply and flushing. The reduction in particle size that increases the surface area will also reduce the hydraulic conductivity and air permeability and increase suction. At some point, lower rates of oxygen supply and water percolation as a result of a reduction in hydraulic conductivity and air permeability and increased suction will start to reduce the rate of oxidation and the dissolution of weathering products.

### 5.7.3 Hydraulic Properties and Drainage Conditions

Hydraulic properties and drainage conditions will affect drainage chemistry through their influence on weathering conditions such as air entry and water percolation. Important hydraulic parameters include hydraulic conductivity, suction and moisture retention. Important drainage conditions include rates and locations of drainage inputs, losses, flow paths and flooding.

Hydraulic properties and drainage conditions will depend on:

- climate, hydrology and hydrogeology of the site (Chapter 6);
- drainage use and water management of the project;

- physical properties of the project components, such as the pore size distribution and arrangement; and
- atmospheric parameters and conditions such as air permeability and temperature.

For example, the particle size distribution and structure and the resulting size and arrangement of voids will affect the degree of saturation and rates of infiltration. Temperature and wind will affect the rates of drainage losses through evaporation and transpiration.

Drainage inputs will depend on the climate, hydrology and hydrogeology of the site and drainage use and water management of the project. Potential sources of drainage inputs include:

- condensation;
- incident precipitation;
- surface runoff;
- near surface seepage from non-lithified overburden;
- groundwater from bedrock;
- process water added with tailings; and
- water used for dust control, drilling and other construction, mining and reclamation activities.

Climate conditions will directly determine the volume and rates of condensation and incident precipitation and in conjunction with the site and project hydrology and hydrogeology, the volume and rates of surface runoff, near surface seepage and groundwater. Whether the ground is saturated and/or frozen may also be an important factor in determining the amount of drainage that infiltrates versus runs off, especially during snowmelt and large rain events.

The timing and relative magnitude of different drainage input and discharge sources will vary depending on the flow paths and climatic conditions. For example, increases in surface and near-surface runoff are likely to precede increases in ground water flow or discharge during storm events. Groundwater

*The timing and relative magnitude of different drainage input and discharge sources will vary depending on flow paths and climatic conditions.*

is likely to become a larger proportion of the drainage inputs during periods with little precipitation or snow melt.

Potential drainage losses include:

- surface runoff;
- seepage discharge to the surface or groundwater;
- evaporation; and
- transpiration if vegetation is present.

The source, rate and location of drainage inputs and flows are important because the dissolution of weathering products will vary with the chemistry of the infiltrating water and the solid to water ratio.



The water balance (i.e. drainage inputs minus drainage losses) is important because flooding can cause major changes to the weathering conditions, stopping air entry, limiting oxidation and increasing the volume of water available for dissolution of soluble minerals. There is often a delay in flooding all or a portion of a project component. The rate of flooding will determine the duration of aerated weathering conditions and therefore may be important in the interpretation of test results and prediction of the chemistry of drainage discharged from flooded excavations or impoundments.

The rate of oxidation depends on the rate of oxygen supply. Therefore, the rate of oxidation in flooded sulphidic geologic materials depends on both the dissolved oxygen concentration and the rate of groundwater flow. Significant oxidation may occur if there are high rates of flow of oxygenated water through the flooded materials. It is therefore important that tests designed to simulate some aspect of flooded material performance duplicate the likely range in the dissolved oxygen supply.

When predicting drainage chemistry, it is important to recognize that many of the site and project

*When predicting drainage chemistry, it is important to recognize that many of the site and project properties and drainage conditions are in flux.*

hydraulic properties and drainage conditions are in flux and the rate, location, chemistry and relative contributions from different project components may change. These changes may be due to:

- variation between individual climate events, different seasons and different years;
- longer term climate change or off site natural or anthropogenic events;
- project activities during different phases of the mine life; and
- changes to the physical and atmospheric properties of project components by weathering and erosion.

Project activities, such as excavation and waste disposal, will change the topographical, physical and hydraulic properties of the landscape and will therefore change the hydrology and hydrogeological properties such as the direction of flow.

Surface and near-surface discharge rates will depend on the initial water content, in addition to drainage inputs. Dry mine wastes are temporary drainage sinks and it may take decades or more to achieve a balance between drainage inputs and outputs. Newly deposited waste rock dumps will initially be drainage sinks and maximum leaching and discharge will not occur until the waste rock dumps become saturated. The rebound of the regional water table after mining may not occur until the mine wastes are wet and the excavated underground workings and open pits are flooded, processes that may take decades.

The creation of new drainage sources and flow paths during mine construction may permanently lower or raise the regional water table. Flooded impoundments may raise the water table. Mine workings may lower the regional pre-mining water table, although the extent to which this occurs is uncertain until flooding, subsidence and collapses are complete, tens or hundreds of years or more after mining is completed.

Changes to important drainage conditions such as drainage inputs, infiltration, flow paths and flooding may be due to natural or anthropogenic events. These include stream migration and the construction or collapse of beaver dams and storm drains. Although the project may not be the cause of these events, they may dramatically change the drainage chemistry and contaminant loadings from various project components.

#### 5.7.4 Atmospheric Properties and Processes

Atmospheric parameters and processes that have a major impact on the rates of sulphide oxidation and other weathering conditions may significantly influence the weathering processes and drainage chemistry. Some of the more important ones include:

- composition of gas phase of the project component;
- air permeability of the project component;
- external climatic conditions;
- rates and locations of air inputs, consumption, discharge and flow paths, and the resulting composition of air within the project component;
- external and internal air temperature; and
- wind erosion and atmospheric fallout.

Air properties and processes within a project component vary with a large number of inter-related external and internal physical, drainage and geochemical parameters and processes. The composition of the gas phase in a project component will depend on the:

*Air properties and processes within a project vary with a large number of inter-related external and internal physical, drainage and geochemical parameters and processes.*

- types and rates of chemical reactions;
- temperature; and
- rate of air entry from the atmosphere.

Chemical reactions occurring in a project component will reduce the concentration of some chemical species in the gas phase and increase the concentrations of others. Sulphide oxidation and other oxidation reactions, such as the oxidation of ammonium from blasting powder and aerobic decomposition of organic matter, will consume oxygen. Carbonate dissolution and bacterial metabolic reactions will produce carbon dioxide. Sulphate reduction may produce hydrogen sulphide.

Changes in temperature will alter the solubility of different gases. Higher temperatures will decrease the solubility of oxygen and carbon dioxide and increase the solubility of water vapour in saturated mine wastes.

Changes in the concentrations of oxygen, carbon dioxide or water vapour will occur where the rates of sulphide oxidation, bacterial reactions, carbonate dissolution or the evaporation of water are high compared to the rate of air supply. The pore gas composition will therefore be a function of the rate of air movement, distance from the surface and chemical reactivity of the geologic materials.

Changes in gaseous composition in various project components may pose a human health concern. Increased concentrations of carbon dioxide and hydrogen sulphide and lower oxygen concentrations may be deadly. Air quality should be checked before entering mine workings, confined locations or depressions at the base of mine wastes.

The rate of air inputs and movement within the project component will depend on the internal and external parameters that control air permeability and drive air movement. Air permeability will depend on parameters, such as the:

- length of flow paths;
- particle size distribution;
- particle arrangement; and
- moisture content.

Air permeability is a function of the minimum diameter of the air filled portion of the voids along flow paths. The higher the degree of saturation and the smaller the pore size, the lower is the air permeability. Materials with larger particles and larger pores are likely to have relatively low pore water contents and high air permeability. Silt sized tailings slimes, with relatively small sized pores, low hydraulic conductivity and high suction are likely to have a relatively high pore water content and low air permeability.

The principal mechanisms of air movement are advection and diffusion. Advection can move air (and oxygen) relatively quickly over large distances. Air flow by diffusion is much slower but may be an important mechanism in fine textured or compacted layers lacking large, interconnected pores.

*The principal mechanisms of air movement are advection and diffusion.*

Air flow by diffusion occurs primarily in response to concentration gradients created by the lower oxygen and higher carbon dioxide concentrations in the gas phase of the project component compared to the surrounding atmosphere.

Air flow by advection can be driven by differences in air temperature, wind and barometric pressure, and changes in gaseous composition. Thermal gradients will result in lighter, hotter air rising (chimney effect) and heavier, colder air sinking. Heat released by sulphide oxidation is often sufficient to increase air temperatures within the project component. Increased internal temperatures can initiate upward temperature and density driven convection currents where it is possible to “draw” atmospheric air into the base and sides.

The magnitude of thermal convection depends on the:

- sulphide oxidation rate;
- air permeability;
- differences in the internal and surrounding air temperatures; and
- magnitude and direction of the pressure and density gradients.

Thermal convection may result in a positive feedback loop between sulphide oxidation, heat production and the oxygen supply. A higher rate of sulphide oxidation increases heat

production, leading to increased air movement and the oxygen supply, which in turn increases the rate of sulphide oxidation and heat production.

The largest differences in temperature between the overlying air and the hot internal atmosphere will occur when external temperatures are low. Consequently, in materials with similar physical and chemical properties, higher convection currents, rates of oxygen supply and heat production will occur in cold climates and during the coldest season. Conversely, an increase in the overlying air temperature will usually reduce the thermal gradient and therefore the rate of oxygen supply to sulphide oxidation.

Convective air movement within a project component may also result from changes in its composition which would change the density of the gas. An increase in water vapour will reduce the density and increase the buoyancy of the gas phase. An increase in the concentration of carbon dioxide will have the opposite affect, increasing the density and reducing the buoyancy.

Convective air movement due to pressure may also result from changes in the water content, barometric pumping and wind. Reduction in water content may increase air entry due to the increased air permeability, in addition to the reduced air pressure. Increased external barometric pressure will result in air entry due to compression of the internal gas phase, while a decrease in external barometric pressure will reduce air entry. Wind pressure will result in greater air entry on the windward compared to the leeward side of a dump.

Constructive feedback may occur between the different driving forces for convection, such as temperature, gas composition and air pressure. For example, higher temperatures that increase sulphide oxidation will also increase the concentration of water vapour and the air pressure, producing more airflow into the pile, which supplies more oxygen and further increases the rate of sulphide oxidation and internal heating.

Higher air density within a dump, due to higher carbon dioxide and lower oxygen concentrations, coupled with summer air temperatures that match or exceed internal dump air temperatures, may reverse the direction of air flow, resulting in air entering the upper dump surface, moving downwards and exiting at the base. The discharge of air with higher carbon dioxide and hydrogen sulphide and lower oxygen concentrations is a potential human health concern and air quality should be checked before entering confined locations or depressions at the base of sulphidic mine components.

*The discharge of air with higher carbon dioxide and hydrogen sulphide and lower oxygen concentrations is a potential health concern.*

Air movement will vary in different portions of a dump. In addition to the windward side, greater air entry typically occurs along the upper sides and adjacent upper surface of a dump. The geometry of a dump will impact air entry and where cells of air circulation can develop. The greater the height to width ratio of the dump, the greater is the potential for advective air movement (Ritchie, 2003).

Solid phase atmospheric inputs and losses include wind blown sediment and other forms of atmospheric fallout. Examples include wind erosion of tailings, wind blown dust from an ore stockpile and atmospheric fallout from an off site agricultural or industrial operation.

### 5.7.5 Temperature

The temperature of project components will depend on heating or cooling due to the:

- overlying air;
- surrounding or underlying ground;
- drainage; and
- sulphide oxidation.

The impact of seasonal decreases or increases in overlying air temperatures on internal temperatures will depend in part on the depth within a project component. The greatest influence of changes in overlying air temperature will occur near the surface. Temperatures deep within a project component will be less of a function of seasonal temperature and depend more on the average overlying air temperature, plus heat added from or lost to the ground and drainage and heat produced by sulphide oxidation.

Sulphide oxidation is an exothermic process and may raise temperatures well above the ambient air temperature. Heat from high rates of sulphide oxidation in project components with high concentrations of sulphide minerals, pH values low enough to dissolve ferric iron and high rates of air entry may result in temperatures exceeding 40°C and in some instances exceeding 60°C. High temperatures may melt snow and kill vegetation. Temperatures may become high enough for project components to catch fire, especially if the material is coal.

*Sulphide oxidation is an exothermic process and may raise temperatures well above the ambient air temperature.*

Permafrost may develop beneath the depth of seasonal melting if project components have low rates of sulphide oxidation and the average overlying air temperatures are well below freezing. In addition to heat produced by sulphide oxidation, high solute concentrations will lower the temperature required for drainage to freeze. It is important to consider future climate warming, in addition to the heat from sulphide oxidation, when considering climate impacts on drainage chemistry and whether materials will remain frozen.

The influence of temperature on weathering and drainage chemistry will occur through its impacts on:

- atmospheric properties, such as air density and solubility of different gases;
- rates of physical weathering processes, such as freeze thaw and thermal expansion;
- sulphide oxidation;
- bacterial activity;
- carbonate solubility;
- formation and dissolution of secondary minerals (e.g. weathering products);

- concentration of solutes upon freezing;
- dissolved oxygen solubility ; and
- reactivity of other acid buffering minerals, including silicates.

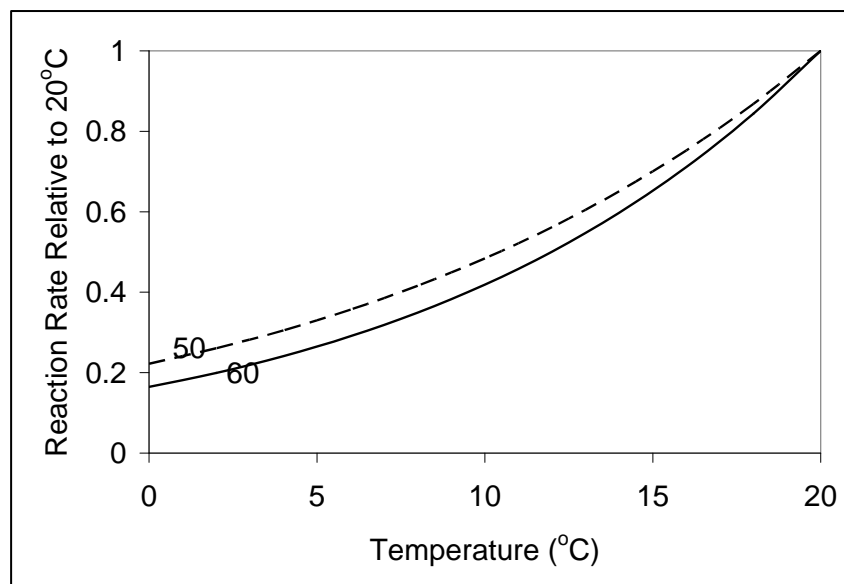
The effect of temperature on the rates of chemical reactions is described by the Arrhenius equation that relates temperature ( $T$ , in Kelvin) to reaction rate ( $K$ , Reaction 5.49) or the relative reaction rates ( $K_1, K_2$ ) at different temperatures ( $T_1, T_2$ ; Reaction 5.50).  $E_a$  is the activation energy of the reaction, and  $R$  is the gas constant.

$$K = Ae^{(-E_a/RT)} \quad (5.49)$$

$$\ln(K_1/K_2) = Ea(T_1-T_2)/R(T_1T_2) \quad (5.50)$$

Cold temperature effects on geochemical processes were reviewed by SRK and Mehling (2006). The variation in the rate of pyrrhotite oxidation calculated using the Arrhenius equation (Reaction 5.49) at different temperatures compared to that at 20°C is shown in Figure 5.6 for two selected activation energies of 50 to 60 KJ/mol. It can readily be seen that the relative reaction rate at 4°C, using these activation energies, are 0.31 to 0.24, respectively (Figure 5.6).

The rates of sulphide oxidation at 4°C relative to that at 20°C ( $K_4/K_{20}$ ) measured in laboratory tests for pyrite and pyrrhotite varied from 0.1 to 1, but were most commonly between 0.2 and 0.4 (Table 5.10). The variable effects of temperature on the rate of sulphide oxidation as evident from the data shown in Table 5.10 are attributable to mineralogical differences and the confounding effects of temperature on other contributing properties and processes.



**Figure 5.6** Relative reaction rates as a function of temperature calculated with the Arrhenius equation for the oxidation of pyrrhotite with activation energies of 50 to 60 KJ/mol (from Day et al., 2005).

**Table 5.10 Relative reaction rates for sulphide oxidation at 4°C and 20°C in laboratory tests by different mines (from Day et al., 2005).**

Site	Tests	Mineral	K4/K20
Calculated		pyrrhotite, pyrite	0.24 to 0.31
Diavik	4	pyrrhotite	0.3 to 0.4
Ekati	2	pyrite	0.26
Pogo	4	arsenopyrite	0.29
		pyrite	0.4 to 0.8
Red Dog Mine	4	pyrite	1
		pyrite	0.37, 0.40
		pyrite	0.11
		pyrite, sphalerite	0.11
Ulu Lake	4	pyrite, arsenopyrite	0.23
		pyrite	0.23
Windy Craggy	11	pyrrhotite, pyrite	0.34 to 0.67

Other potential impacts of a decrease in temperature include the following.

- A decreasing temperature increases the solubility of CO<sub>2</sub>, which in turn will lower the pH and increase the solubility of carbonate minerals and the dissolved concentrations of metals such as zinc that would precipitate as carbonates.
- Partial freezing of drainage will increase solute concentrations in the remaining water so long as no mineral solubility limits are exceeded. Higher solute concentrations may increase contaminant concentrations and may also decrease the freezing point.
- The oxygen concentration in drainage increases with decreasing temperature from 7 mg/L at 35°C to 14 mg/L at 0°C at atmospheric pressure. Dissolved oxygen increased by a factor of 1.4 as the temperature decreased from 15°C to 0°C (Elberling, 2001).

The overall effect of colder temperatures may depend on factors with opposite effects. Over a similar temperature decrease (35°C to 0°C), oxygen diffusivity in flooded tailings decreased by a factor of 1.6, resulting in an overall 90% reduction in the oxygen flux (Elberling, 2001).

The overall effect of a lower temperature on the rate of carbonate dissolution and the depletion of the carbonate neutralizing potential will depend on the relative magnitude of the lowering of pH due to an increase in the solubility of CO<sub>2</sub> compared to the increase in pH due to the decrease in the rate of acid generation caused by a reduced rate of sulphide oxidation. The overall effect of a lower temperature on dissolved metal concentrations will depend on whether metal concentrations are controlled by the rate of sulphide oxidation or, the solubility limits of carbonate or non-carbonate minerals.

### 5.8 Drainage Chemistry from Sulphidic Geologic Materials

As a result of the relatively high concentrations of rapidly weathering minerals, drainage from exposed sulphidic geologic materials typically contains elevated concentrations of sulphate, base cations, metals and trace elements (Table 5.11). However, due to variable composition and weathering conditions, the drainage chemistry is highly variable. For example, pH may range from less than 1 to more than 9, with similar large ranges in the concentration of acidity and alkalinity.

Sulphidic geologic materials commonly contain a number of rapidly weathering minerals in addition to the sulphides themselves. These include carbonates, sulphates, oxyhydroxides, fine grained phyllosilicates and organic compounds. Consequently, many elements are derived from more than one source. Elevated sulphate, trace elements and iron may come from sulphide oxidation. Sulphate and trace elements may be products of hydrothermal alteration (e.g. sulphate from gypsum) or organic matter (e.g. Se). Base cations (e.g. Ca, Mg, Na, K) could result from the dissolution of carbonate and sulphate minerals and the hydrolysis of silicate minerals.

The total concentration of an element in drainage is the sum of its concentrations in dissolved species, either as free ions or complexes with ligands and those associated with suspended solids.

**Table 5.11 Examples of sulphidic mine drainage from mines in eastern Canada; except for pH, concentrations of all parameters are in mg/L (from Blowes et al., 2003).**

	<b>INCO Copper Cliff</b>	<b>Campbell Mine</b>	<b>Delnite</b>	<b>Heath Steele (old basin)</b>	<b>Kidd Creek</b>	<b>Nickel Rim</b>	<b>Waite Amulet</b>	<b>Nordic Elliot Lake</b>
pH	3-8	6.5-8.5	6.8-7.8	1-7.5	3-7	3-6.5	2.5-7.5	1.4-5
Fe	27-1637	135	35	48000	0.5-400	9810	10000	23000
SO <sub>4</sub>	5890	50-6100	1900-2600	85000	2000-22000	24200	20000	50000
Zn	1.8	2.5	1.5	3690	0.1-4100	7.49	250	15
Ni	12.48-66.07	<0.05	4.75	10	3	396	15	25
Cu	9.76	<0.02	0.2	70	3	5.05	60	15
Pb	0.11	<0.5	0.27	10	2.5	0.35	5.1	6
As	0.2	80	45	-	<0.10	-	-	-
Co	0.6-0.97	0.1-0.4	-	100	-	8.9	8.9	35

In addition to dissolved elemental concentrations, other important drainage properties include chemical speciation (e.g. the redox state of arsenic), temperature, TSS, redox potential, organic acids, conductivity, hardness, alkalinity, acidity and pH. These properties impact the rate and form of kinetic weathering reactions, solubility limits (the maximum carrying capacity), the resulting drainage chemistry and the environmental impact of the drainage.



### 5.8.1 Dependency of Metal Solubility on pH

The solubility of most metals and metalloids released into solution either directly or indirectly by sulphide oxidation is strongly pH dependent. Under oxidizing conditions, the solubility of most cations increases as the pH decreases from near-neutral and slightly basic to more acidic pH values. Some cations (e.g. Be[II], Zn[II], Al[III], and Fe[III]) are amphoteric and their solubility also increases as the pH increases from near-neutral and slightly basic to more basic pH values.

*The solubility of most metals and metalloids released into solution by sulphide oxidation is strongly pH dependent.*

At neutral pH, anionic species of As, Cr, Mo, S, Se, and V generally form weak, soluble complexes with monovalent or divalent cations, but at acidic pH's they may be precipitated by high concentrations of dissolved Fe(III) and Al(III). The solubility of elements that exist as oxyanions such as As, Cr, Mo, S, Sb will increase with an increase in pH due to the concurrent reduction of the anion exchange capacity of oxyhydroxide minerals.

The dissolved concentrations of many chemical species will depend on the precipitation and dissolution of sulphate, carbonate and oxyhydroxide minerals. Decreasing the pH will also decrease the precipitation of Al, Fe and Mn oxyhydroxides and sulphate or carbonate minerals.

### 5.8.2 Iron

If the pH is near-neutral, iron released by weathering will precipitate in-situ directly, either replacing the weathered mineral or as coatings or suspended flocs. If the pH is sufficiently acidic, drainage from weathering sulphidic geologic materials typically contains elevated concentrations of dissolved Fe.

In addition to iron sulphides, other iron sources include silicates, carbonates and oxyhydroxides. Reductive dissolution of secondary iron oxyhydroxides may occur when oxidized sulphidic materials are flooded or when the water table is raised by the construction of tailings impoundment over previously oxidized non-sulphidic materials such as topsoil. Ferric iron gives mine drainage and surfacing groundwater its red or orange colour.

### 5.8.3 Aluminum

Aluminum (Al) occurs in only one oxidation state (+3) in geologic materials. Aluminum is amphoteric and its solubility increases as the pH decreases below 4.5 to 5.5 and above pH 7. If the pH is near-neutral, aluminum released by weathering will precipitate in-situ, directly replacing the weathered mineral as coatings or as suspended flocs.

Dissolved aluminum may derive from a wide variety of reactions and dissolutions of hydroxide, silicate and sulphate minerals. Aluminum oxyhydroxide solids include both minerals and amorphous material, with increasing crystallinity decreasing the Al solubility. Higher concentrations of dissolved Al typically occur at acidic pH's rather than at basic pH's due to the higher rates of aluminosilicate weathering reactions.

The passage of suspended colloidal size aluminum oxyhydroxide through filters used to prepare a dissolved sample may result in Al analyses exceeding the solubility limits.

#### 5.8.4 Barium

Ba occurs in only one oxidation state ( $\text{Ba}^{2+}$ ). One of the least soluble barium minerals is barite ( $\text{BaSO}_4$ ), which often limits Ba concentrations in drainage.

#### 5.8.5 Strontium

The two most common minerals of  $\text{Sr}^{2+}$  are strontianite ( $\text{SrCO}_3$ ) and celestite ( $\text{SrSO}_4$ ). Modeling calculations indicate that celestite and strontianite are generally too soluble to limit Sr concentrations. Strontium's solubility is commonly limited by co-precipitation with the Ca carbonates or adsorption by clays (Langmuir et al., 2004).

#### 5.8.6 Cadmium, Zinc and Nickel

Under aerobic conditions, below pH 8, dissolved concentrations of Zn, Cd and Ni are commonly controlled through adsorption or co-precipitation with oxyhydroxides of iron, manganese, and aluminum. Above pH 8, dissolved concentrations of Zn, Cd and Ni are commonly controlled by the precipitation of minerals, such as carbonates.

#### 5.8.7 Lead

Lead solubility is restricted by its strong adsorption by Fe and Mn oxyhydroxides and the insolubility of lead minerals such as anglesite ( $\text{PbSO}_4$ ) and cerrusite ( $\text{PbCO}_3$ ).

#### 5.8.8 Manganese

Manganese has three possible valence states: 2+, 3+ and 4+. In addition to forming its own minerals, manganese can substitute for iron, magnesium and calcium in many other common minerals. The ion  $\text{Mn}^{2+}$  is more stable than  $\text{Fe}^{2+}$  over a wide range of pH and Eh conditions.  $\text{Mn}^{2+}$  is stable under oxidizing conditions at  $\text{pH} < 4$  and reducing conditions at  $\text{pH} < 9$ .  $\text{MnO}_2$  is stable and relatively insoluble at  $\text{pH} > 5-7$  in strongly oxidized systems, and  $\text{MnOOH}$  and  $\text{Mn}_3\text{O}_4$  are stable under  $\text{pH} > 8$  under less oxic conditions.

Mn oxides are often stronger sorbents of trace metals than iron oxyhydroxides. Rhodochrosite ( $\text{MnCO}_3$ ) is a relatively common Mn mineral while manganese sulphide is rare.

### 5.9 References

Abraitis, P.K., R.A.D. Pattrick and D.J. Vaughan. 2004. Variations in the Compositional, Textural and Electrical Properties of Natural Pyrite: A Review. *International Journal of Mineral Processing*. 74(1-4): 41–59.

Alpers, C.N., D.W. Blowes, D.K. Nordstrom and J.L. Jambor. 1994. Secondary Minerals and Acid Mine-water. In: J.L. Jambor and D.W. Blowes (eds.) *The Environmental Geochemistry of Sulfide Mine-wastes*. Mineralogical Association of Canada Short Course Series. Volume 22.

- Birkeland, P.W. 1974. *Pedology, Weathering and Geomorphological Research*. Oxford University Press.
- Blanchard, R. 1968. *Interpretation of Leached Outcrops*. Nevada Bureau of Mines, Bulletin 66.
- Blowes, D.W. and C.J. Ptacek. 1994. *Acid-Neutralization Mechanisms in Inactive Mine Tailings*. In: J.L. Jambor and D.W. Blowes (eds.) *Environmental Geochemistry of Sulfide Mine-Wastes*. Mineralogical Association of Canada Short Course Series, Volume 22.
- Blowes, D.W., C.J. Ptacek and J. Jurjovec. 2003. *Mill Tailings: Hydrogeology and Geochemistry*. In: J.L. Jambor, D.W. Blowes and A.I.M. Ritchie (eds.) *Environmental Aspects of Mine Wastes*. Mineralogical Association of Canada Short Course Series, Volume 31.
- Busenberg, E. and L.N. Plummer. 1982. *The Kinetics of Dissolution of Dolomite in CO<sub>2</sub>-H<sub>2</sub>O Systems at 1.5° to 65°C and 0 to 1 atm pCO<sub>2</sub>*. *American Journal of Science*. 282: 45-78.
- Busenberg, E. and L.N. Plummer. 1986. *A Comparative Study of the Dissolution and Crystal Growth Kinetics of Calcite and Aragonite*. *U.S. Geol. Surv. Bull.* 1578: 139-168.
- Chou, L., R.M. Garrels and R. Wollast. 1989. *Comparative Study of the Kinetics and Mechanisms of Dissolution of Carbonate Minerals*. *Chemical Geology* 78(3-4): 269-282.
- Cravotta, C.A.I. 1994. *Secondary Iron-Sulfate Minerals as Sources of Sulfate and Acidity*. In: C.N. Alpers and D.W. Blowes (eds.) *204th National Meeting of the American Chemical Society, San Diego, California*.
- Czerewko, M.A., J.C. Cripps, J.M. Reid and C.G. Duffell. 2003. *Sulfur Species in Geological Materials – Sources and Quantification*. *Cement & Concrete Composites*. 25: 657-671.
- Daniels, W.L. and Z.W. Orndorff. 2003. *Acid Rock Drainage from Highway and Construction Activities in Virginia, USA*. In: T. Farrell and G. Taylor (eds.) *Proceedings from the Sixth International Conference on Acid Rock Drainage, Cairns, Australia, July 14-17, 2003*.
- Day, S., W. Kuit and M. Filion. 2003. *Evolution of Mine Drainage Chemistry, Red Dog Mine, Alaska*. In: *Proceeding of the 10th Annual British Columbia MEND ML/ARD Workshop, Performance of ARD Generating Wastes, Material Characterization & MEND Projects*. Vancouver, British Columbia, December 2-3, 2003.
- Day, S., K. Sexsmith, D. MacGregor, P. Mehling, S. Shaw and U. Kestler. 2005. *Cold Temperature Effects on Geochemical Weathering*. In: *Proceedings of 12th Annual British Columbia - MEND ML/ARD Workshop, Challenges in the Prediction of Drainage Chemistry*. Vancouver, British Columbia, November 30 - December 1, 2005.
- Drever, J.I. 1988. *The Geochemistry of Natural Waters*: Prentice Hall, Englewood Cliffs, New Jersey.

- Elberling, B. 2001. Environmental Controls of the Seasonal Variation in Oxygen Uptake in Sulphidic Tailings Deposited in a Permafrost-affected Area. *Water Resources Research*. 37(1): 99-107.
- Goldich, S.S. 1938. A Study on Rock Weathering. *Journal of Geology*. 46: 17-58.
- Greenberg, J. and M. Tomson. 1992. Precipitation and Dissolution Kinetics and Equilibria of Aqueous Ferrous Carbonate vs. Temperature. *Applied Geochemistry*. 7(2): 185-190.
- Hammarstrom, J.M., K. Brady and C.A. Cravotta III. 2005. Acid-rock Drainage at Skytop, Centre County, Pennsylvania, 2004. U.S. Geological Survey Open-File Report 2005-1148.
- Hanor, J.S. 2000. Barite-Celestine Geochemistry and Environments of Formation. In: N.A. Alpers, J.L. Jambor and D.K. Nordstrom (eds.) *Sulfate Minerals – Crystallography, Geochemistry and Environmental Significance*. *Reviews in Mineralogy and Geochemistry*. 40: 193-275.
- Hicks, S. 2006. Acidic Airport Drainage - Over 20 Years Worth of Experience. In: *Proceedings of the MEND Maritimes Workshop, Challenges in Acidic Drainage: Case Studies on Mitigation Technologies and Current Research*. Halifax, Nova Scotia, May 23-25. 2006. MEND Report W.018.
- Jambor J.L. 2003. Mine-Waste Mineralogy and Mineralogical Perspectives of Acid-Base Accounting - Chapter 5. In: J.L. Jambor, D.W. Blowes and A.I.M. Ritchie. (eds.) *Environmental Aspects of Mine Wastes*. Mineralogical Association of Canada Short Course Series, Volume 31.
- Jambor, J.L. and D.W. Blowes (eds.) 1994. *Environmental Geochemistry of Sulfide Mine-Wastes*. Mineralogical Association of Canada Short Course Series, Volume 22.
- Jambor, J.L. and D.W. Blowes. 1998. Theory and Applications of Mineralogy in Environmental Studies of Sulfide-bearing Mine Wastes. In: L. Cabri and D.W. Vaughn (eds.) *Modern Approaches to Ore and Environmental Mineralogy*. Mineralogical Association of Canada Short Course Series, Volume 27.
- Jambor, J.J., D.K. Nordstrom and C.N. Alpers. 2000. Metal-sulfate Salts from Sulfide Mineral Oxidation. In: C.N. Alpers, J.L. Jambor and D.K. Nordstrom (eds.) *Sulfate Minerals: Crystallography, Geochemistry, and Environmental Significance*. Mineralogical Society of America and Geochemical Society, Washington, D.C. 40: 303-350.
- Jambor, J.L., C.J. Ptacek, D.W. Blowes and M.C. Moncur. 2005. Acid Drainage from the Oxidation of Iron Sulphides and Sphalerite in Mine Wastes. In: T. Fujisawa (ed.) *Proceedings of Lead and Zinc '05 Conference*, Kyoto, Japan, Volume 1.
- Jerz, J.K. and J.D. Rimstidt. 2004. Pyrite Oxidation in Moist Air. *Geochimica et Cosmochimica Acta*. 68(4): 701-714.

Klein, C. and C.S. Hurlbut Jr. 1993. *Manual of Mineralogy* (after J.D. Dana). John Wiley and Sons. p. 681.

Koyanagi, V.M. and A. Panteleyev. 1994. Natural Acid Rock Drainage in the Red Dog-Hushamu-Pemberton Hills Area, Northern Vancouver Island (92L/12). In: *Geological Fieldwork 1993*. B.C. Ministry of Energy and Mines (Note: The current Ministry of Energy, Mines and Petroleum Resources was formerly the Ministry of Energy and Mines).

Kwong, Y.T.J. 1993. Prediction and Prevention of Acid Rock Drainage from a Geological and Mineralogical Perspective. MEND Report 1.32.1. p. 47.

Kwong, Y.T.J. 1996. Mineralogical Controls of Sulfide Oxidation - II. Field Implications. NHRI Contribution Series, CS-96008. p. 65.

Kwong, Y.T.J. and K.D. Ferguson. 1997. Mineralogical Changes During NP Determinations and their Implications. In: *Proceedings of the Fourth International Conference on Acid Rock Drainage*, Vancouver, British Columbia, May 31 - June 6, 1997. Vol 1: 435-447.

Kwong, Y.T.J. and J.R. Lawrence. 1994. Mineralogical Controls of Sulfide Oxidation. NHRI Contribution Series, CS-94010. p. 87.

Kwong, Y.T.J., G.W. Swerhone and J.R. Lawrence. 2003. Galvanic Sulphide Oxidation as a Metal-leaching Mechanism and its Implications. *Geochemistry, Environment, Analysis*. 3: 337-343.

Langmuir, D., P. Chrostowski, B. Vigneault and R. Chaney. 2004. Issue Paper on the Environmental Chemistry of Metals. Report to U.S. Environmental Protection Agency Risk Assessment Forum. p. 114.

Lapakko, K.A. and D.A. Antonson. 1994. Oxidation of Sulfide Minerals Present in Duluth Complex Rock: A Laboratory Study. In: *Environmental Geochemistry of Sulfide Oxidation*; ACS Symposium Series 550. American Chemical Society, Washington, DC, 1993.

Lapakko, K.A. and D.A. Antonson. 2002. Drainage pH, Acid Production, and Acid Neutralization for Archean Greenstone Rock. Preprint 02-73. In: *Proceedings of the 2002 SME Annual Meeting*, Phoenix, Arizona, February 25-27. Soc. for Mining, Metallurgy, and Exploration, Inc. Littleton, Colorado.

Lapakko, K.A., D.A. Antonson and J.R. Wagner. 1997. Mixing of Limestone with Finely-crushed Acid-producing Rock. In: *Proceedings of the Fourth International Conference on Acid Rock Drainage*, Vancouver, British Columbia, May 31 - June 6, 1997. Vol. 3: 1345-1360.

Lett, R., W. Jackaman and S. Sibbick. 1996. Spring Water and Spring Sediment Geochemistry of the Gataga Mountain Area. B.C. Ministry of Energy, Mines and Petroleum Resources. Open File 1996-30. (Note: The current Ministry of Energy, Mines and Petroleum Resources was formerly the Ministry of Energy and Mines).

Morin, K.A. and N.M. Hutt. 1997. Environmental Geochemistry of Minesite Drainage: Practical Theory and Case Studies. Minesite Drainage Assessment Group. p. 333.

Morin, K.A., N.M. Hutt, T.S. Coulter and W.M. Tekano. 2003. Case Study of Non-mining Prediction and Control of Acid Rock Drainage - the Vancouver Island Highway Project. In: T. Farrell and G. Taylor (eds.) Proceedings of the Sixth International Conference on Acid Rock Drainage, Cairns, Australia, July 14-17, 2003. The Australian Institute of Mining and Metallurgy.

Moses, C.O., D.K. Nordstrom, J.S. Herman and A.L. Mills. 1987. Aqueous Pyrite Oxidation by Dissolved Oxygen and Ferric Iron. *Geochimica et Cosmochimica Acta*. 55: 1261-1271.

Nicholson, R.V. 1994. Iron-Sulfide Oxidation Mechanisms: Laboratory Studies. In: J.L. Jambor and D.W. Blowes (eds.) Environmental Geochemistry of Sulfide Mine-Wastes. Mineralogical Association of Canada Short Course Series, Volume 22.

Nordstrom, D.K. 1982. Aqueous Pyrite Oxidation and the Consequent Formation of Secondary Iron Minerals. In: J.A. Kittrick, D.S. Fanning and L.S. Hossner (eds.) Soil Sci. Soc. Am. Special Publication. 10: 37-56.

Nordstrom, D.K. 2003. Effects of Microbiological and Geochemical Interactions in Mine Drainage. In: J.L. Jambor, D.W. Blowes and A.I.M. Ritchie (eds.) Environmental Aspects of Mine Wastes. Mineralogical Association of Canada Short Course Series, Volume 31.

Nordstrom, D.K. and C.N. Alpers. 1999. Geochemistry of Acid Mine Waters. In: G.S. Plumlee and M.J. Logsdon (eds.) The Environmental Geochemistry of Mineral Deposits, Rev. Econ. Geol. V. 6A.

Ollier, C. 1969. Weathering. Elsevier, New York.

Petruk, W. 2000. Applied Mineralogy in the Mining Industry by Elsevier.

Plumlee, G.S. 1999. The Environmental Geology of Mineral Deposits. In: G.S. Plumlee and M.J. Logsdon (eds.) The Environmental Geochemistry of Mineral Deposits, Part A: Processes, Techniques, and Health Issues. Reviews in Economic Geology, 6A.

Plumlee, G., K. Smith, M. Montour, W. Ficklin and E. Mosier. 1999. Geological Controls on the Composition of Natural Waters and Mine Waters Draining Diverse Mineral-deposit Types. In: The Environmental Geochemistry of Mineral Deposits. Part B: Case Studies and Research Topics. Vol. 6B, Chapter 19. Reviews in Economic Geology. Society of Economic Geologists, Inc., Chelsea, MI.

Pons, L.J., N.J. Van Breemen and P.M. Driessen. 1982. Physiography of Coastal Sediments and Development of Potential Soil Acidity. In: Acid Sulphate Weathering. Soil Science Society of America. Special Publication 10: 1-18.

Price, W.A. 2005. Review of 2004 Waste Rock Storage Area Seepage and Waste Rock Survey Report for Ekati Mine. Ekati Independent Environmental Assessment Agency. September 7.

Price, W.A. and Y.T.J Kwong. 1997. Guidelines for the Prediction of Acid Rock Drainage and Metal Leaching for Mines in British Columbia. Part III. Waste Rock Weathering, Sampling and Analysis: Observations from the British Columbia Ministry of Employment and Investment Database. In: Proceedings of the Fourth International Conference on Acid Rock Drainage, Vancouver, British Columbia, May 31 - June 6, 1997. Vol 1: 31-45.

Pugh, C.E., L.R. Hossner and J.B. Dixon. 1984. Oxidation Rate of Iron Sulfides as Affected by Surface Area, Morphology, Oxygen Concentration, and Autotrophic Bacteria. *Soil Science*. 137(5): 309-314.

Rimstidt J.D. and D.J. Vaughan. 2003. Pyrite Oxidation: A State-of-the-art Assessment of the Reaction Mechanism. *Geochimica et Cosmochimica Acta*. 67(5): 873–880.

Ritchie, A.I.M. 2003. Oxidation and Gas Transport in Piles of Sulfidic Material. - Chapter 4. In: J.L. Jambor, D.W. Blowes and A.I.M. Ritchie (eds.) *Environmental Aspects of Mine Wastes*. Canadian Mineralogical Association of Canada Short Course Series, Volume 31.

Singer, P.C. and W. Stumm. 1970. Acid Mine Drainage: The Rate Determining Step. *Science*. 167: 1121-1123.

SRK Consulting Ltd. and Mehling Environmental Management Inc. 2006. Update on Cold Temperature Effects on Geochemical Weathering. MEND Report 1.61.6.

Stantec Consulting Ltd. 2004. Review of Water Quality Issues in Neutral pH Drainage: Examples and Emerging Priorities for the Mining Industry in Canada. MEND Report 10.1.

Stumm, W. 1992. *Chemistry of the Solid-water Interface: Processes at the Mineral-water and Particle-water Interface*. New York: Wiley InterScience.

Stumm, W. and J.J. Morgan. 1996. *Aquatic Chemistry*, 3rd ed. New York: John Wiley & Sons, Inc.

White, W.W. III and T.H. Jeffers. 1994. Chemical Predictive Modeling of Acid Mine Drainage from Metallic Sulfide-bearing Rock. In: *Environmental Geochemistry of Sulfide Oxidation*; ACS Symposium Series 550; American Chemical Society: Washington, D.C. 1993.

Williamson, M.A., C.S. Kirby and J.D. Rimstidt. 2006. Iron Dynamics in Acid Mine Drainage. In: R.I. Barnhisel (ed.) *Proceedings of the Seventh International Conference on Acid Rock Drainage*, St. Louis, Missouri, USA, May 31-June 4, 2006. American Society of Mining and Reclamation (ASMR).





## 6.0 SITE CONDITIONS

### *Some Important Points in this Chapter*

*Because prediction of drainage chemistry requires a great deal of site specific information, this chapter lists and discusses many important aspects of site conditions. Local and regional geography, climate, hydrology, and hydrogeology should be defined. Since drainage chemistry will likely change with mining, detailed investigations of geological issues are also needed, including spatial variations in soils, overburden and rock units. Other important aspects of site conditions are the requirements and expectations of the local community, regulators, company, and other stakeholders.*

### 6.1 Introduction

An understanding of the site will be used to identify potential concerns, select samples and analyses and interpret results for different waste materials, site components and the project as a whole. Developing an understanding of general properties of the site should therefore be one of the first steps in any drainage chemistry prediction program.

General properties of the site that should be reviewed prior to predicting drainage chemistry typically include:

- geography;
- baseline conditions;
- climate;
- hydrology and hydrogeology;
- regulatory, community and corporate needs for environmental protection and reclamation;
- geology; and
- project history, plans and components (Chapter 7).

More detailed and accurate site and project information, paralleling the requirement for more detailed and accurate predictions of drainage chemistry, may be required as the project develops.

### 6.2 Geography and Baseline Conditions

Potentially useful information about the geography and baseline conditions for the prediction of drainage chemistry includes the type, location, dimensions, and chemical and physical properties of the following:

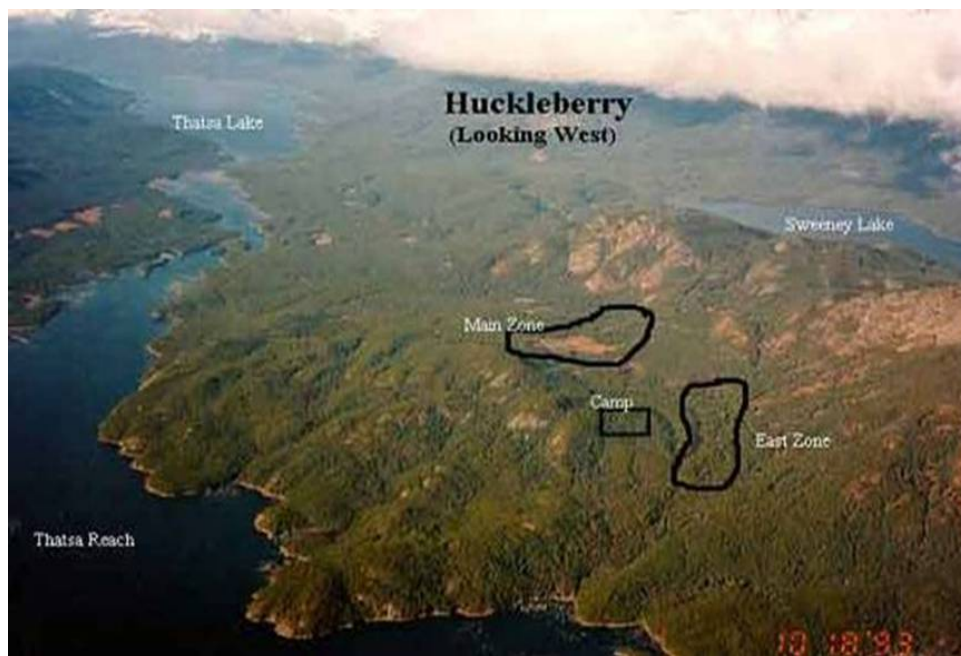
- roads, navigable waters, air transportation, trails and any impediments to travel to and around the site;
- landforms and topographical features and provision of a topographic map;
- pre-mining drainage, soils, vegetation, aquatic biota and terrestrial fauna;
- previous causes of disturbance such as glaciation and fire;
- social and archaeological features;

- fish and wildlife species and habitat, species sensitivity, barriers to fish passage, and habitat limitations;
- natural soil and sediment development; and
- past, present and potential uses of terrestrial and aquatic resources.

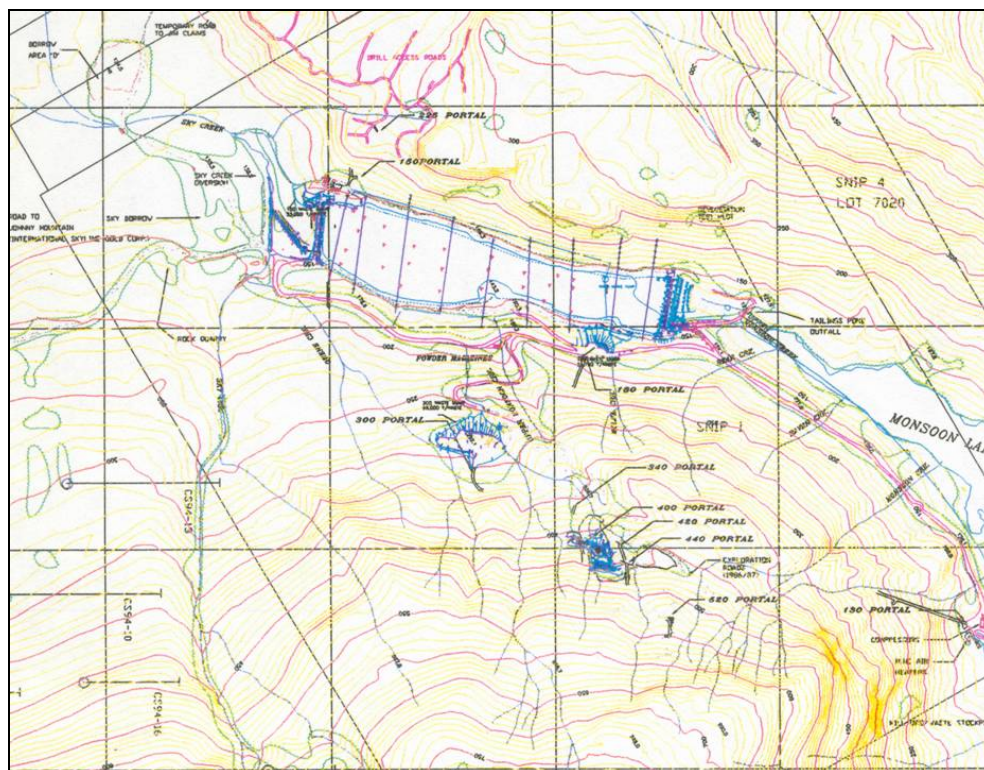
Access may affect the ability to conduct monitoring, sampling and field trials. Baseline studies of soils and drainage should identify local inputs and weathering conditions and the resulting drainage chemistry. Baseline studies are also needed to establish the type and locations for final discharge points and discharge limits and environmental protection and reclamation objectives

*Access may affect the ability to conduct monitoring, sampling and field trials.*

(Figure 6.1). For example, baseline studies were part of the information used to set discharge limits for the drainage chemistry at the Huckleberry Mine (Figure 6.1). Potentially useful information about the geography and baseline conditions should be shown on maps (e.g. Figure 6.2).



**Figure 6.1** Baseline studies were part of the information used to set discharge limits for the drainage chemistry at the Huckleberry Mine.



**Figure 6.2 A topographical map showing the water courses and landforms associated with the tailings impoundment and surface openings of the underground mine at the Snip Mine.**

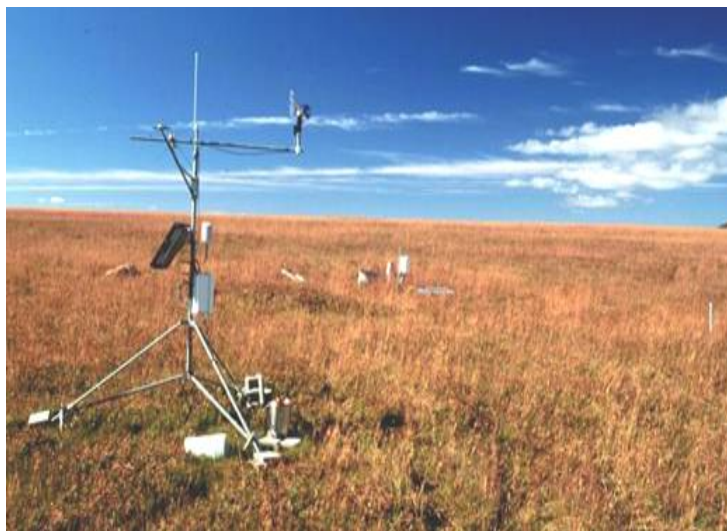
### 6.3 Climate

Climatic parameters and processes such as precipitation, temperature, depth of freezing and snow melt will impact weathering, leaching, aqueous concentrations, loadings, and seasonal and annual variations in drainage chemistry. Climate will be a consideration in the selection and design of tests. The differences in flow and temperature between the test work and the actual mine component can affect rates of weathering and leaching conditions. Therefore, site precipitation and temperature should be considered in the design of kinetic tests and in the interpretation of the resulting data.

*Climate will be a consideration in the selection and design of tests.*

Potentially useful information about the climate for the prediction of drainage chemistry includes the following:

- precipitation;
- temperature;
- the proportion of precipitation occurring as snow;
- snow depth and water content;
- magnitude and timing of the snow melt and other major runoff events;
- snow-free period;
- periods of drought; and
- evapotranspiration.



**Figure 6.3** An example of a monitoring station set up to measure site climate conditions.

Climatic data typically comes from long term data sites in locations with similar climatic conditions and from monitoring stations set up at the site (Figure 6.3). Climatic conditions within the mine wastes depend in part on the physical and chemical properties of the waste and may differ significantly from the ambient surface climatic conditions. For example, heat produced by sulphide oxidation may result in higher temperatures. Runoff, evaporation and evapotranspiration reduce the amount of infiltration, which in turn may reduce leaching.

#### 6.4 Hydrology and Hydrogeology of the Site

Hydrologic and hydrogeologic properties and processes of the site play major roles in determining weathering conditions and the rates and locations of leaching and discharge. Therefore, they play major roles in determining drainage chemistry and potential environmental impacts. When initiating a program to predict drainage chemistry, it is important to identify hydrological and hydrogeological features of the site and start measuring key properties and processes as soon as possible.

*Hydrology and hydrogeology play major roles in determining drainage chemistry and potential environmental impact.*

Potentially useful important hydrologic and hydrogeologic information regarding the project area include the following:

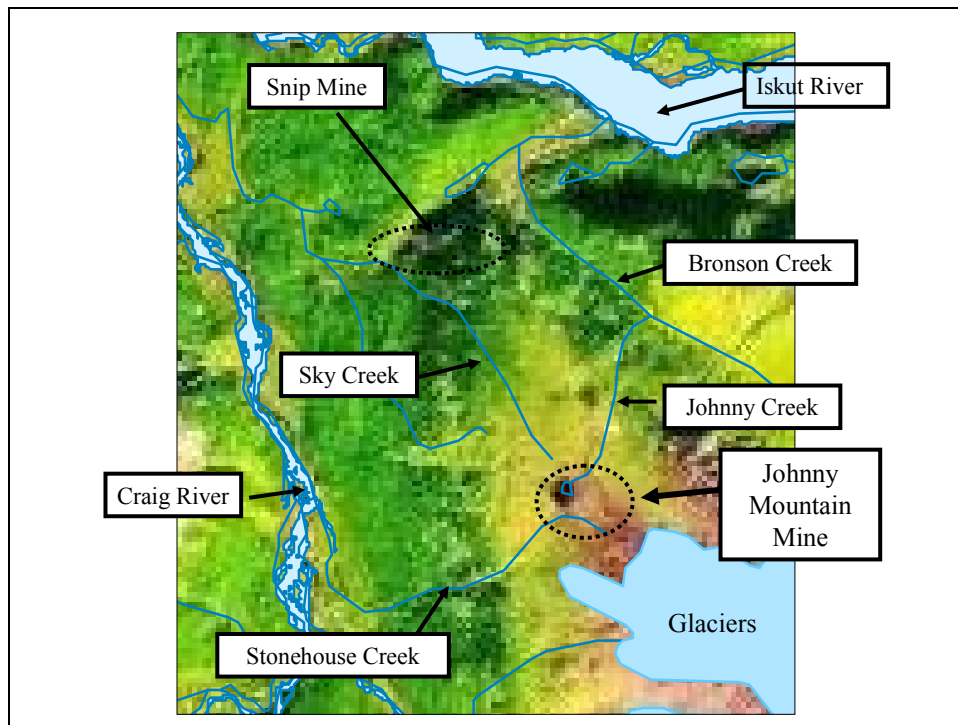
- water courses, including location, flow rate and water quality, gradient, diversions, significant sources of solutes, features that may cause large fluctuations in flow, such as beaver dams, and other potentially important features;
- wetlands, runoff, near surface seepage and springs;
- watersheds, including catchments, major drainage sources and sinks (e.g. glaciers) and the range in elevation; and
- hydrological and hydrogeological features resulting from the project.



These drainage features should be shown on site plans (e.g. Figures 6.2 and 6.4).

Contaminant loadings (i.e. drainage chemistry multiplied by rate of flow) from the mine components will determine the potential for downstream environmental impacts (Figure 3.6). When initiating a program to predict drainage chemistry, it is important to start measuring properties and processes of the hydrology and hydrogeology of the site as soon as possible (Section 3.20). Where feasible, weirs or some other flow measuring device should be installed to measure flow at all locations where flow may be important for the calculation of loadings and the water balance (Figure 6.5).

One of the greatest challenges in determining the hydrologic and hydrogeologic properties is to identify sub-surface features, such as near-surface seepage, and processes that may occur during wetter seasons or years. Near-surface seepage will cause runoff and flooding when the topsoil is removed and when there is deep cutting and filling of overburden for the construction of roads or foundations. Many wet years are likely to be encountered during the mine's life. Soil properties will indicate the location of near-surface seepage and where groundwater discharge and the height of the water table will occur seasonally and during wetter seasons or years. A soil survey can be used to predict the potential drainage inputs, leaching, erosion, flow paths and discharge locations of each project component and therefore would be important to include as part of the pre-mine prediction program. It would also be useful to conduct soil and topographic surveys prior to the construction of project components.



**Figure 6.4 An aerial photograph is an effective way of showing the location of the major water courses at the Johnny Mountain Mine.**



**Figure 6.5 Weirs can be constructed to measure flow at all major water quality monitoring locations.**

### **6.5 Regulatory, Community and Corporate Needs for Environmental Protection and Reclamation**

Regulatory, community and corporate needs for environmental protection and reclamation are the goal posts for evaluating the significance of predicted drainage chemistry and will impact the prediction objectives and the required precision and accuracy. Potentially useful information regarding regulatory, community and corporate needs for the prediction of drainage chemistry include the following:

- regulatory agencies, their permits, requirements and guidelines for the prediction of drainage chemistry;
- permit conditions for discharges such as discharge limits, monitoring, dilution and receiving environment objectives, including rationale for decision and approvals;
- end land use and receiving environment objective(s), financial security and reclamation requirements; and
- results of human health and ecological risk assessments, including valued species, species sensitivity and potential mechanisms of exposure.

Guidance should be sought from the Provincial and Federal Government, local government, First Nations, aboriginal groups and local residents.

## 6.6 Geology

A major part of developing an understanding of the general properties of the project and site and the first step in any drainage chemistry prediction program is the identification, description and mapping of the bedrock and non-lithified surficial materials (soil) that will be or has been excavated, exposed or otherwise disturbed (Section 3.2). Since much of the variability in drainage chemistry results from geological properties, geological information is required to ensure that all the possible sources of drainage chemistry are evaluated. While often overlooked in the rush to do drainage chemistry specific tests, an understanding of site geology is critical in:

*The first step in any drainage chemistry prediction program is the identification, description and mapping of the bedrock and non-lithified surficial materials (soil) that will be or has been excavated, exposed or otherwise disturbed.*

- interpreting drainage chemistry-specific tests results;
- calculating the mass of different materials; and
- designing an appropriate sampling plan (Chapter 8).

An understanding of the geology is also important in ensuring that the more expensive, less frequently conducted analyses and tests (e.g. mineralogy and kinetic tests, Chapters 17 and 18) are conducted on samples that are representative of the materials of concern.

The understanding of geology and the spatial distribution of different geologic materials, such as the boundaries between different rock types and the intensity and forms of alteration, may be revised as the project develops and new information is collected. Drainage chemistry prediction should be adjusted for any significant revisions or refinements in the understanding of potentially relevant geological properties.

The information required in the initial reconnaissance of rock and soil types can generally be derived from existing geological information such as:

- bedrock and terrain mapping;
- exploration and production drill logs;
- exploration reports;
- metallurgical test work;
- block models;
- geo-environmental mineral deposit models; and
- other relevant geological studies.

### 6.6.1 Genesis of Bedrock and Soils

Information on the formation or genesis of bedrock and soils is useful in predicting the composition, geochemical properties and spatial differences in composition of the geologic materials. This includes:

- deposit type;
- host and associated rock types;
- depositional materials, processes and conditions;

- subsequent intrusion, deposition, hydrothermal alteration, supergene depletion or enrichment and surficial weathering; and
- physical constraints on the spatial distribution.

When reviewing information on the formation of a deposit, it is important not to lose sight of the objective, which is to determine the present composition in order to predict the impact of geologic materials on the drainage chemistry. Information on the genesis of the geologic materials can be a useful guide to the possible or probable spatial distribution and composition of different geologic materials. However, this information needs to be confirmed through comprehensive sampling and analysis. Due to a lack of detailed sampling and mineralogical analysis, there is often significant speculation in exploration reports. One needs to distinguish measured versus hypothesized properties and the potential errors and omissions in those measurements when attempting to ascertain the resulting composition (e.g. mineralogy and lithologies) of the rock.

*Information on genesis of the geological materials can be a useful guide to the possible or probable spatial distribution and composition of different geologic materials.*

### **6.6.2 Influence of Genesis on the Spatial Distribution of Key Properties**

The genesis of geologic materials may result in spatial differences in composition that have important effects on drainage chemistry and how the materials should be handled. For example, spatial differences in the deposition of minerals, such as calcite and pyrite, will affect the distribution of potentially net acidic rock. Examples of this are the pyrite halos that may surround porphyry deposits. Information on spatial distribution should be used when designing a sampling plan (Chapter 8).

The distribution of minerals in relation to each other and to veins and fractures may affect the exposed surface area and subsequent reactivity when the rock is excavated. Information on the spatial distribution of different geologic materials could be useful in the design of test work, operational material characterization and interpretation of results.

Spatial differences in composition may result from:

- proximity to an igneous intrusion, source of hydrothermal fluids or weathering agents;
- physical differences that impact alteration, such as different fracture densities; and
- changes in the composition of migrating fluids.

Prior to mining, drilling is often primarily within the depth of ore required for the mine to be economic and may be limited in deeper regions or waste material beyond the zone of economic mineralization. Less frequent drilling laterally or at depth may be an important limitation in tailings and waste rock characterization (Chapter 8). For example, in porphyry systems, materials with higher percentages of acid generating minerals sometimes occurs beyond the ore perimeter.



### 6.6.3 Geo-Environmental Models of Mineral Deposits

Mineral deposits are naturally occurring masses of economically valuable metallic or non-metallic minerals that are not necessarily economically recoverable. Geo-environmental mineral deposit models are compilations of geological and geochemical data from known examples of specific deposit types (Kwong, 2003; Plumlee, 1999; Seal and Foley, 2002; Seal and Hammarstrom, 2003). Mineral deposit types are groups of mineral deposits with similar geological characteristics, geological environments of occurrence and geological processes of formation (Plumlee, 1999). Geo-environmental mineral deposit models for different deposit types indicate past and present:

- processes of formation;
- trace element geochemistry;
- mineral assemblages and alteration types; and
- spatial distribution of different geochemical conditions.

Geo-environmental mineral deposit models are a means of anticipating likely geochemical conditions and potential challenges that may arise from the geological attributes associated with specific types of deposits (Seal and Hammarstrom, 2003). Mineral deposit type and geo-environmental models cannot encompass all the possible combinations of site environmental conditions, host rock, intrusions, alterations and mining conditions. Therefore geo-environmental mineral deposit models can guide and support, but should not substitute for comprehensive site specific sampling and analysis of the geochemical composition and prediction tests and monitoring of drainage chemistry needed as the basis for mine or environmental plans.

*Geo-environmental mineral deposit models can guide and support drainage chemistry predictions, but should not substitute for the required comprehensive sampling, analyses, and testwork.*

The spatial distribution of different mineral assemblages and alteration types in deposits of a similar type may provide a useful guide to the geochemical composition of un-characterized or poorly characterized areas of a deposit. Geo-environmental deposit models are also a useful guide to likely and less obvious geochemical conditions. For example, while skarns and other carbonate hosted deposits are considered the least likely deposit type to generate acidic drainage because of the plentiful acid neutralizing minerals (Kwong, 2003), the placement of high concentrations of iron sulphide minerals in Cu and Fe skarn deposits can result in acidic drainage from some rock units (Seal and Foley, 2002). The placement of high concentrations of iron sulphide minerals in Cu and Fe skarn deposits has resulted in acid drainage generating tailings at the Tasu and Texada mines in British Columbia.

### 6.6.4 Differentiation and Description of Geological Units

One of the tasks that should be performed as part of a review of general geological information should include the initial separation or differentiation of the geologic materials into geological units. The differentiation of geological units is typically based on:

- mode of primary formation (e.g. sedimentary, igneous and metamorphic for rock; or colluvium, fluvial, marine and till for non-lithified materials);

- distinct forms of physical or geochemical alteration resulting from hydrothermal alteration, supergene depletion or enrichment, surficial weathering or other processes impacting the type, style and degree of mineralization; and
- location within the excavation or relative to the mineral deposit (e.g. footwall and hanging wall).

Ideally, geologic materials can be separated into discrete, homogeneous units. However, in some

*Ideally, geologic materials can be separated into discrete, homogeneous units. However, in some cases, the geologic materials are highly variable, even over small distances.*

cases, the geologic materials are highly variable, even over small distances. Where changes occur irregularly, along continuums or so often that it is impossible to separate the non-lithified materials or rock mass into

discrete homogeneous units, the geologic material should be divided into “management” units, based in part on their size and location (e.g. Table 6.1). For example, bench or adit heights may be used to divide separately, manageable units of waste rock.

Data from individual descriptions of geologic materials should be used to describe the central tendency, variability and spatial distribution of properties and the locations and descriptions for each geological unit. Variability is an important consideration in the segregation of different materials and in ensuring that all potential outcomes in drainage chemistry are predicted. Information on the variability of different analytical properties may also indicate whether additional sub-division and segregation of rock types is needed or is practical.

Where possible, the description of geologic materials should include the following:

- location, mass (tonnes) and dimensions of material observed and being described;
- location, mass (tonnes) and dimensions of material that the sample material is intended to represent;
- mode of formation;
- grain size;
- structure – bedding, stratification and lamination;
- fracture density – cracks, joints, faults and breaks;
- rock strength and competency:
  - hardness;
  - slaking characteristics;
- lithology;
- mineralogy - type, spatial distribution and quantities:
  - bulk and vein mineral assemblages;
  - parent material mineral assemblages;
  - alteration mineral assemblages (e.g. products of hydrothermal alteration, supergene alteration and other forms of weathering);
  - organic content;
  - location of reactive minerals (disseminated, concentrated on fracture surfaces, etc.);
- nature and extent of weathering:
  - depth and degree of processes such as oxidation;
  - evidence of solute movement and precipitation;
- colour;

Table 6.1 A description of local geological units.

Geology Model Rocktype <sup>1</sup>	Rocktype Label and Code <sup>1</sup>	No. of ABA Samples	Description <sup>2</sup>
<b>Fortuna Zone</b>			
Saprolite	SAP-F (01)	72	<p><b>OVB</b> Fe-oxide clay rich, sometimes hematitic, organics observed, quartz fragments can exist. Depth ranges from 1 to 5 metres.</p> <p><b>SAP</b> Fe-oxide clay rich, kaolin observed as pseudomorph replacement of protolith crystals and fragments.</p> <p>Distinguished from OVB and classified as saprolite when relic textures can be observed (i.e. crystals or fragments).</p> <p>Best gold values associated with quartz-goethite-limonite- manganese veining commonly fragmented.</p> <p>Locally hematitic, this weathered profile exists commonly down to 25 metres, but observed down to 60 metres.</p> <p>The main difference between SAP-F and SAP-B is gold grade, overall grade is overall in the Botija zone (possible Au enrichment).</p> <p><b>SPK</b> Similar to SAP, but the competency of the weathered profile increases; unable to scratch or indent the core with the use of a finger. A transition to the underlying bedrock, commonly not thicker than 10 metres.</p>
Basement Volcanics	BVOL-F (02)	9	<p><b>BVOL</b> Basement volcanic sequence exists as mafic flows and as heterolithic pyroclastics. Carbonate stable, magnetic, pyritic, no gold.</p> <p><b>AND</b> and <b>BAS</b> Massive coherent flows, mafic, magnetic, carbonate stable.</p> <p><b>LAT/LBT/LAP/ABT</b> facies exist in BVOL, basalt fragments observed, carbonate stable.</p>
Pyroclastics	PCT-F (03)	77	<p><b>PCT</b> Pyroclastic airfall and block-ash flows, heterolithic, contains siltstone sedimentary fragments, pumice fragments can exist, locally bedded, can be well sorted to poorly sorted. Mineralized when affected by intense quartz -adularia alteration or when "brown" veining (quartz-oxide) exists. This unit makes up 50% of the zone. No carbonates observed. Size varies for this pyroclastic sequence.</p> <p><b>LAT/LBT/LAP/ABT/ASH/BT</b> Composition of the fragments vary, but commonly observed 60% felsic volcanic fragments: 30% sedimentary fragments: 10% pumice fragments. LAT and ASH will commonly show sorting and layering.</p> <p><b>LBT/LAP/ABT/BT</b> units show block size felsic volcanic fragments, dacitic in composition.</p>
Felsic Dome Complex	FDC-F (04)	73	<p><b>FDC</b> Felsic dome complex, dacitic to rhyolitic in composition.</p> <p>VBX and FBX are fragmental facies of this dome, commonly hematitic matrix, homolithic fragments (dacite or rhyolite in composition). 30-50% matrix / 50-70% fragments. VBX is generally very local, distal facies to the felsic dome complex and not as coarse. FBX is more proximal and coarser.</p> <p>DAC is green, intermediate, fine grained, locally porphyritic and massive.</p> <p>RHY is banded, more felsic, fine grained, with hematitized bands.</p>
Diabase Dykes	DIAB-F (05)	3	<b>DIAB</b> Magnetic, chloritic, carbonate stable, youngest unit, no gold.
Undefined	UNF-F (06)	0	
<b>Botija Zone</b>			
Saprolite	SAP-B (07)	33	<b>SAP</b> As described for Fortuna, deeper and appears more mineralized.
Basement Volcanics	BVOL-B (08)	16	<b>BVOL</b> As described for Fortuna, closer to the surface, more holes intersected this unit
Pyroclastics	PCT-B (09)	42	<b>PCT</b> As described for Fortuna, more extensive in this zone, more ignimbritic or pupumaceous.
Felsic Dome Complex	FDC-B (10)	24	<b>FDC</b> Differs from Fortuna in that no extrusive rhyolite facies are observed (i.e. no FBX or RBX). An intrusion exists which may be equivalent: RHY/ITR. The dome facies is made up of dacite in coherent and fragmental form.
Diabase Dykes	DIAB-B (11)	0	<b>DIAB</b> Does not exist in the Botija zone.
Undefined	UNF-F (12)	0	
<b>Fuente Zone</b>			
Volcanics	VOL-F (13)	31	<b>VOL</b> Dacite flows, massive to vesicular and locally fragmental, strong pyrite disseminated and vein controlled, carbonate stable, locally hematitic.
Undefined	UNF (15)	0	
Total		380	
<sup>1</sup> from Geology Model by Placer Dome REG Group <sup>2</sup> personal communication from D. Bahrey, Project Geologist			

- spatial distribution of physical, chemical and mineralogical features listed above;
- eventual or existing project components and forms of disturbance and exposure (e.g. pit wall, tailings, ore or waste rock - Chapter 7); and
- any other diagnostic features significant to present and future drainage chemistry.

The description should indicate the method or methods used to collect the information, such as visual evaluation or some smaller scale, more refined form of analysis. Particular attention should be paid to aluminosilicate, sulphide and carbonate mineralogy. For example, evidence of carbonate minerals may include the browning of iron carbonate minerals and the results of the hydrochloric acid fizz test. Also, differences in properties such as colour and grain size may be important in the field identification and segregation of geological units requiring separate handling. Properties such as fracturing, rock strength and vein versus bulk mineralogy may impact the mass and composition of the < 2 mm size fraction of post-blast waste rock.

Differences in colour may be evidence of differences in mineralogy, nature and extent of weathering processes such as oxidation and solute precipitation. Colour is affected by moisture and therefore it is important to state whether the colour is for moist or dry material. Comparison with coloured chips in a Munsell colour book may be used to provide a more accurate description.

Observations of the changes caused by natural weathering processes prior to mining may provide

*When using pre-mining weathering to predict post-mining weathering, one should consider the potential effects of differences in the time of exposure and phase of weathering and conditions, such as air entry and leaching.*

useful information about post-mining weathering changes. When using pre-mining weathering to predict post-mining weathering, one should consider the potential effects of differences in the time of exposure and phase of weathering and conditions, such as air entry and leaching. Rates of air entry and leaching and therefore the rates of

weathering reactions in natural surficial materials or naturally fractured bedrock, may be significantly slower and the resulting weathering conditions different than in waste rock or tailings. Natural weathering may have been occurring for many millennia, exhausting the most rapidly weathering minerals and proceeding beyond the phase with maximum solute concentration.

The main source of descriptive information of geologic materials prior to mining is the logging of drill core. During mining, geological descriptions may be obtained from new diamond drilling core, drill cuttings, mine walls and post-blast muck piles. Rock exposure and operational material characterization during mining may provide new geological information leading to changes in the classification and segregation of different rock types.

The description and separation of geological units should be conducted by persons with the proper training and knowledge of bedrock and surficial geology, and the project geology (Section 3.22).

### 6.6.5 Description of Soil and Other Non-Lithified Overburden

Additional information reported for soil and non-lithified overburden, such as glacial till or saprolite, should also include the following:

- depth and lateral extent;
- texture and particle size distribution; and
- changes and depths of changes in surface coatings, organic matter and other properties such as pH resulting from weathering, leaching and plant growth.

Drilling into weathered, fractured or non-lithified materials breaks apart particles and mixes

*Drilling into weathered, fractured or non-lithified materials breaks apart particles and mixes weathered surfaces with fresh, unweathered surfaces, altering the particle size and masking the surface chemistry.*

weathered surfaces with fresh, unweathered surfaces, altering the particle size distribution and masking the surface chemistry. Alteration to the particle size distribution may result in misclassification of material type. During planning for the Huckleberry Mine in British Columbia, this resulted in the misclassification of the highly fractured, upper layer of bedrock as till

and an overestimation of the till available for dam construction. The presence of fresh, unweathered surfaces can complicate predictions of drainage chemistry that will result from the leaching of the existing, weathered surfaces.

### 6.6.6 Description of the Geologic Material in Existing Project Components

For existing project components, the geological description could also include the following:

- mode of excavation, material handling, deposition and/or exposure;
- quantity (weight, volume and/or aerial extent); and
- additional information reported for the characterization of soil and non-lithified overburden.

### 6.6.7 Geological Mapping

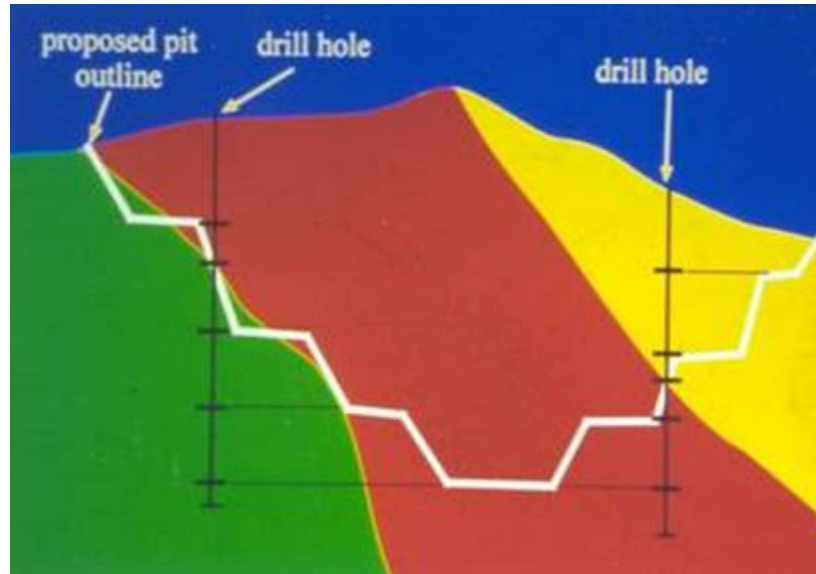
It may be useful to prepare geologic cross sections (Figure 6.6) and plan view maps (Figure 6.7) to show the location and spatial relationship of all:

- geologic units and forms of alteration;
- proposed project components, such as openpits or underground excavations;
- proximity to sources of mineralization, alteration, weathering or leaching; and
- existing forms of disturbance.

The project should be mapped in sufficient detail to show the topography of the project areas and

*Geologic mapping and block models can also be used for environmental geochemical data interpretations and presentations.*

the surrounding terrain, the underlying strata and any permanent or intermittent water courses (e.g. at least 1:5000). The mapping should also indicate if any other disturbance has occurred or is occurring in the same watershed.



**Figure 6.6** A description and mapping is needed for all the geologic materials excavated, exposed or disturbed by mining.



**Figure 6.7** Geological block models are used in most mines for mapping environmental geochemical information.

## 6.7 References

Kwong, Y.T.J. 2003. Comprehensive Environmental Ore Deposit Models as an Aid for Sustainable Development. *Exploration and Mining Geology*. 12: 31-36.

Plumlee, G.S. 1999. The Environmental Geology of Mineral Deposits. In: G.S. Plumtree and M.J. Logsdan (eds.) *The Environmental Geochemistry of Mineral Deposits, Part A: Processes, Techniques, and Health Issues*. *Reviews in Economic Geology*. 6A: 71-116.

Seal, R.R. II and N.K. Foley. 2002. Progress on Geoenvironmental Models for Selected Mineral Deposit Types. U.S. Geological Survey Open-File Report 02-195.

Seal, R.R. II and J.N. Hammarstrom. 2003. Geoenvironmental Models of Mineral Deposits: Examples from Massive Sulphide and Gold Deposits. In: J.L. Jambor, D.W. Blowes and A.I.M. Ritchie (eds.) *Environmental Aspects of Mine Wastes*. Mineralogical Association of Canada Short Course Series, Volume 31.





## 7.0 THE PROJECT AND PROJECT COMPONENTS

### *Some Important Points in this Chapter*

*Each project and site can be divided into components, such as open pits, underground workings, waste rock dumps, low grade ore stockpiles, tailings impoundments and borrow materials. Drainage predictions can then be developed for each component, based on its unique combination of site conditions and design. These predictions require site specific information on a myriad of combinations of physical, geochemical, biological and engineering properties and processes. This chapter lists and discusses many of these properties and processes, including how they may change through time. For example, initial drainage chemistry from an open pit may reflect weathering of the mine walls, but later chemistry may reflect the ongoing accumulation of finer grained talus with greater reactive surface area. Also, rising or falling water tables can greatly change the rate of sulphide oxidation while inversely affecting the loadings in drainage.*

### 7.1 Introduction

During the various phases of a project, geologic materials are excavated, exposed, disturbed, processed, moved, reused and deposited, creating individual project components and the project as a whole. The large variety of types and combinations of materials and methods create a wide variety of possible project components. These include the different types

*During the various phases of a project, geologic materials are excavated, exposed, disturbed, processed, moved, reused and deposited. This creates individual project components and the project as a whole.*

and the various disposal options or uses for:

- excavations;
- waste rock;
- ore and low grade ore;
- processing products and wastes;
- reprocessing products and wastes;
- secondary wastes from drainage treatment;
- sediment from drainage collection systems;
- non-lithified overburden; and
- borrow materials.

Some of the more common project components are listed in Table 7.1.

**Table 7.1 Common project components**

Open pits	Underground workings
Waste rock dumps	Low grade ore stockpiles
Ore stockpiles	Impounded tailings and/or other waste products (treatment sludge)
Roads and air strips	Foundations of buildings
Dams	Ditches surrounding or extending between other components
Processing facilities	Lay down areas
Load out facilities	Mixture of the above
Rock cuts and borrow pits	

On an area or mass basis, the largest components at most mines are the mine workings and the impoundments and dumps used to store tailings and waste rock. The excavations and the large volumes of excavated geologic waste materials make mine sites very different from other industrial sites where changes to the landscape are temporary and contaminant sources can be physically removed.

Other potentially large site components at mines are:

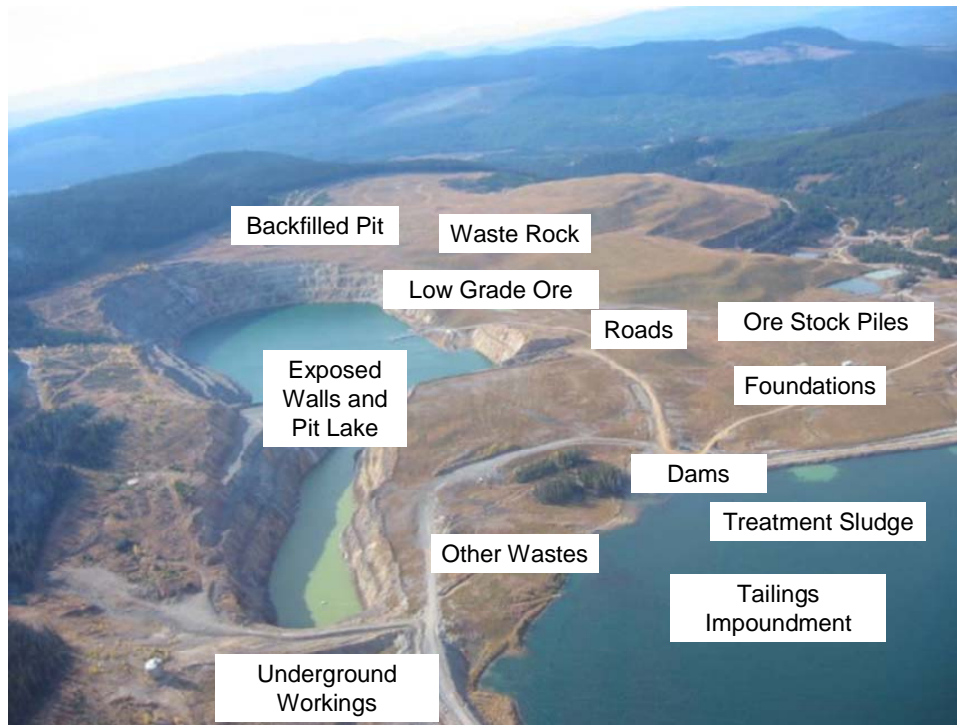
- supporting infrastructure, such as dams, airstrips and roads;
- stockpiles of topsoil and other non-lithified overburden removed to access mine workings, create stable foundations or for use in reclamation and constructing mine facilities (e.g. dams); and
- secondary wastes produced from the long term treatment of acidic drainage.

At some sites, more of the waste rock is used to construct tailings impoundment dams, roads and airstrips than is placed in dumps. Also, a large area or volume may be required to store the secondary products from drainage treatment due to factors such as their low density, the length of treatment or large volumes of drainage requiring treatment.

Many mine sites have a large number of different project components with the potential to produce problematic drainage chemistry. This is especially true at older mine sites where material handling plans did not consider drainage chemistry and thus the waste products were widely distributed around the site and used for construction (Figure 7.1).

The drainage chemistry and loadings produced by a project and the associated environmental impact, liability and risk will depend on:

- properties, processes and performance of each individual project component;
- interactions between different project components; and
- interactions between the project and the site.



**Figure 7.1** There often are a large number of different sulphidic mine components.

Each project and project component will have different drainage chemistry as a result of its unique combination of waste materials, geologic materials, site conditions and development plans. The drainage chemistry from each geologic unit, waste product and portion or location in a project component will depend on:

- geochemical composition, including sulphide content;
- exposed surface area;
- weathering conditions; and
- leaching rates.

Information on the central tendency and variability in these properties is needed to:

- select samples;
- design analyses, tests and monitoring;
- interpret and scale-up results;
- design and implement mitigation plans;
- identify materials that can be used for construction;
- limit the exposure of geologic materials that are prone to metal leaching;
- estimate mitigation costs; and
- focus prediction work on materials and conditions of potential concern.

The variability of geochemical composition, particle surface area, weathering conditions, rate of leaching, the resulting drainage chemistry and contaminant loading will depend on the dimensions, mass, location, age, mineralogy, physical properties and atmospheric conditions of the various project components. The physical, geochemical, atmospheric and hydraulic properties of the resulting waste products and project components will depend on the composition of the original geologic materials and the methods of:

- excavation,
- disturbance,
- processing,
- materials handling,
- deposition,
- mitigation.

For example, the methods of excavation, processing and deposition will determine the particle size. Processing will remove geochemical constituents altering the geochemical composition. Gravimetric segregation of different minerals and particle sizes during deposition will alter geochemical and hydraulic properties.

## 7.2 Excavations: Open Pits and Underground Workings

The two main categories of excavations used to reach and extract ore, coal, construction materials and other commodities of value are open pits and underground workings. Open pit mining is used when the commodity is near the surface and the amount of waste is not too large. Other names for an open pit are quarry, open cut, open cast and strip mine. A surface feature sometimes associated with near surface underground workings is a glory

*The two main categories of excavations used to reach and extract ore, coal, construction materials and other commodities of value are open pits and underground workings.*

hole. This is a surface depression created by an underground excavation which continues to the surface. A glory hole can also be created by the removal of the crown pillar supporting the surface. Ore in the glory hole is removed through the underground workings.

Open pits excavated to obtain bedrock for construction are often called quarries. Open pits excavated to obtain topsoil and other non-lithified overburden for construction purposes are often called borrow pits. Predictions of drainage chemistry should be made for all excavations, even borrow pits and quarries, which are usually a considerable distance from a mine or not associated with mining (Section 3.2).

The potential sources of inorganic contamination in drainage from open pits, underground workings and borrow pits include:

- mine walls and the associated fractures and talus;
- backfill;
- construction materials; and
- geologic materials that are blasted or broken but not removed.

### 7.2.1 Mine Walls and the Associated Fractures and Talus

Weathering and leaching occur on walls, fractures, residual rock particles from the blast and from talus surfaces. The rock walls usually have a limited surface area and most of the rock particles from the blast are removed. Thus, the majority of the weathering surface area is in fractures and on talus (broken rock) created when portions of the wall collapse. For example, if the vertical and horizontal fracture spacing is 1 meter and the fracture depth is 5 meters, the reactive weathering surface in fractures behind the wall will be 21 m<sup>2</sup> for each m<sup>2</sup> of exposed wall. Field studies of fractures in rock walls during mine expansion found oxidation in fractures at depths of up to 15 meters. The average ratios of estimated fracture surface area to mine wall surface area at the three study sites were 27 to 161:1 (Morwijk Enterprises, 1995; Morin and Hutt, 2006).

*Weathering and leaching occur on walls, fractures, residual rock particles from the blast and from talus surfaces.*

Bedrock walls will collapse into underlying or adjacent voids. If the voids are large enough and not backfilled, eventually talus will have a larger particle surface area and become a larger contributor to the drainage chemistry than the fractured mine walls.

Fracture and talus production and surface area will depend on a large number of site specific properties and processes. These include:

- pre-excavation fracture density;
- strength of the overlying soil and rock;
- mining methods and blasting techniques;
- broken rock left after blasting;
- the shape and dimensions of the walls and underlying or adjacent voids;
- the amount of void space filled and the settlement of backfill;
- rates and time of exposure to physical and chemical weathering;
- hydraulic pressure; and
- measures taken to increase wall stability.

Information on fracture density is often recorded in the logging of drill core prior to mining as an aid to mine design. Unloading and chemical and physical weathering after the walls are exposed, will increase the number and size of the fractures, causing progressive wall and roof failures and increasing the mass of broken rock.

The rock exposed to weathering on fracture surfaces and the fine particle size fraction of talus are likely to form in zones of rock weakness such as fault zones and areas of clay alteration. Thus, they may have a different geochemical composition than the rest of the rock in the mine walls.

Talus production will be limited by the void space and buttressing by backfill or previously produced talus. The rate of talus production is difficult to predict due to the difficulty in measuring many of the contributing properties and processes.

Drainage chemistry will depend on the mass and leaching that occurs in talus produced by different rock types.

Mass wasting creating talus in open pits often first occurs on the upper benches. A lower strength of the geologic materials on the upper benches may occur because the walls are:

- non-lithified overburden;
- bedrock exposed to weathering prior to mining; or
- the first of the final walls constructed and therefore exposed to weathering longer than the lower walls.

Mass wasting from the upper pit benches may cover lower benches, limiting talus production from bedrock lower in the pit. Theoretically, talus production from the walls of an open pit will continue until the talus reaches its angle of repose.

While a visual assessment of the source, mass and leaching of the talus may be possible in an open pit, talus production in inaccessible underground mines may only be noticed if it results in surface subsidence or new drainage discharge locations.

Large wall failures and unstable ground conditions prior to closure may make further mining uneconomic and change drainage chemistry.

### 7.2.2 Backfill

Backfill may be a major contributor to drainage chemistry. It commonly has the largest particle

*Backfill may be a major contributor to drainage chemistry. It commonly has the largest particle surface, and may thus be the largest source of weathering products in mine workings.*

surface and may thus be the largest source of weathering products in mine workings. By reducing wall expansion and collapse, backfill may decrease the overall rock particle surface area and therefore the

influence of in situ talus and fractures. The impact of backfill weathering products on drainage chemistry will depend on the degree to which they are leached.

The objectives in backfilling voids created by mining an ore body or coal deposit are to:

- reduce the disposal costs;
- reduce the volume of waste products requiring disposal in other facilities;
- provide ground support, which may increase the removal of the valuable commodity;
- replicate the pre-mining landforms; and
- mitigate sulphide oxidation or contaminant discharge.

Due to the expanded volume, only a portion of the originally excavated material can be used as backfill.

Waste rock, tailings, quarry and borrow materials can be used as backfill. Waste rock and non-lithified overburden are usually trucked or moved by a drag line to the backfill location. The strength in backfilled coarser waste rock used for ground support is typically provided by inter-particle friction.

Tailings can be pumped or fed by gravity to the backfill location. The two tailings products commonly used for ground support are hydraulic and paste tailings. Hydraulic tailings are

slurries of cycloned tailings sand. They typically contain 30 to 40% solids and therefore produce large volumes of water upon draining. The post-deposition strength in backfilled hydraulic tailings is also provided by inter-particle friction after the slurry drains. To enable hydraulic tailings to drain in a timely manner and create sufficient inter-particle friction, the solid fraction must be relatively free of fine particles.

A paste is a dense, viscous mixture of solids and water that, upon standing, adheres together and does not segregate. Paste tailings are whole tailings that are slightly dewatered or thickened to minimize segregation during transportation and to increase their initial strength. Experience has shown that materials in which at least 15% of the particles are less than 20  $\mu\text{m}$  are likely to exhibit paste properties.

Waste rock or aggregate can be added to backfilled tailings to increase the strength and volume. Compounds like cement, hydrated lime and fly ash may be added to increase the strength of the backfilled tailings and accelerate the curing of paste tailings. The amount of cement added to paste tailings typically varies from 2 to 10% (Mehling, 2006).

The materials selected for use as backfill will depend on backfill needs, material availability, transportation costs and the resulting physical properties and drainage chemistry. Waste rock or additional quarried materials may be crushed to create additional fine backfill where there are insufficient process tailings (e.g. Snip Mine in British Columbia). Quarried rock or aggregate and cement may be used as backfill where the present or future geochemistry of the tailings and waste rock is unsuitable. For example, fluvial aggregate is used as backfill for ground support in the Eskay Creek mine in British Columbia.

*The materials selected for use as backfill will depend on backfill needs, material availability, transportation costs and the resulting physical properties and drainage chemistry.*

In a general sense, backfilling can occur in many ways. For example, backfilling in active underground mine workings includes the disposal of waste rock and various tailings products in exhausted headings. Waste rock may be backfilled from the active to the exhausted side of an active open pit. Waste rock and tailings can be backfilled into adjacent, previously mined pits and underground workings if the haul distance is not too far. In strip mining of coal deposits, the drag line commonly backfills non-lithified and bedrock overburden into the previous strip of excavations.

### 7.2.3 Other Materials

Other materials contributing to the drainage chemistry from mine workings include construction materials and sulphidic geologic materials that are broken apart by blasting but left in the mine. Potentially important construction materials include cement, a potential source of alkalinity and galvanized steel, a potential source of zinc.

Blasted rock may be left in place instead of being processed or removed to a planned waste disposal site when mines close prematurely. Examples of blasted rock left in the excavations that became major sources of poor drainage chemistry are:

- waste rock left in the open pit of the Kitsault Mine in British Columbia;
- rock left in the open pit at the East Kemptville Mine in Nova Scotia (now removed); and
- ore left in the underground workings of Tulsequah Chief Mine in British Columbia

In all three situations, the residual broken rocks significantly affected the drainage chemistry due to their relatively high surface area, sulphide concentrations, low pH and/or high rates of leaching compared to the rest of the mine. Other factors contributing to the significance of these materials are a lack of neutralization, attenuation and dilution prior to discharge.

#### 7.2.4 Hydraulic Properties and Drainage Conditions

Drainage conditions in excavations will depend on the hydrology and hydrogeology of the site

*Drainage conditions in excavations will depend on the hydrology and hydrogeology of the site, the size and location of mine openings, water management, drainage inputs and output rates and the discharge locations.*

(Chapter 6), the size and location of mine openings, water management, drainage inputs and output rates and the discharge locations. Incident precipitation will enter through mine openings and will be minimal in underground mines, unless they are connected to open pits or glory holes. Surface runoff will enter along pit edges although

stream diversions, ditches and sumps may be used to divert surface water away. Near surface seepage will enter through mine walls, declines and ramps, surface ventilation raises, glory holes and areas of subsidence. Groundwater will enter through drill holes, fractures and permeable bedrock. Another potential source of drainage is condensation.

Due to their topographical position, mine workings may be hydraulic sinks for runoff and groundwater and have higher drainage inputs, discharge and contaminant loadings per unit area or per unit particle surface area than other project components. Drainage inputs into an underground mine often occur predominantly in discrete locations and as a result, flowpaths and the leaching of weathering products may be restricted to a limited portion of the mine. Some areas of the mine workings may be too dry to have any discharge. In some cases, drainage will flow along the floor of the drift and only condensation may leach the weathering products on piles of talus and fractures in the walls and roof (Morwijk Enterprises, 1995; Morin and Hutt, 2006).

During mining, drainage inputs may also include: process water with backfilled tailings; water used for drilling; water produced when excavations or drill holes intersect flooded fractures or local saturated zones; and drainage from standpipes inserted to increase wall stability. Drainage accumulating in the workings can be removed by pumping or, if the mine is at a higher elevation, by directing drainage out to portals. The higher hydraulic conductivity of the workings, along with pumping and gravity drainage, can lower the regional water table.

Large changes to drainage conditions can occur at closure. Inputs of process water, pumping, gravity drainage and any backfill may stop once the mine closes. As a result, portions of the mine may flood and the regional water table would then rebound towards pre-mining conditions. At some sites after mining closure, diversions may be breached, increasing drainage inputs into pits and underground workings. Surface subsidence may increase drainage inputs, whereas



sealing drill holes, surface raises and other entry points will reduce drainage inputs. Evaporation may be a significant source of water loss from flooded open pits.

Flooding will result in dissolution of any secondary minerals that have precipitated from process

*Flooding will result in dissolution of any secondary minerals that have precipitated from process water or from previous weathering.*

water or from previous weathering. Unlike the flow along the floor of an adit, flooding may wash weathering products from piles of talus and fractures in the walls and roof. Flooding may also result in drainage discharge through previously drained fractures and drill holes.

The extent of flooding will depend on the relative rates of drainage inputs and outputs and the discharge locations. Even if there have been temporary mine closures prior to flooding, there is often considerable uncertainty regarding the:

- locations and rates of drainage losses through fractures and drill holes intersected by mine workings; and
- rebound in the regional water table and resulting rate of drainage inputs after mine closure.

Uncertainty regarding the hydraulic conductivity of fractures and the height of the regional water table may result in considerable uncertainty regarding the height of flooding and discharge locations for the mine water down gradient of the mine. Seasonal variation in drainage inputs may result in: large fluctuations in the height of flooding, annually flushing weathering products from intermittently exposed portions of the mine, changing flow paths and adding new discharge locations down gradient of the excavations. Subsidence and wall failures may also change the locations of flow paths, local flooding and discharge locations.

The leaching and discharge of soluble contaminants already present or produced by the weathering will depend on drainage chemistry and the rate and direction of flow within the flooded regions of the workings. The initial flooding and any subsequent flow may result in significant leaching and discharge of soluble contaminants.

### 7.2.5 Atmospheric Parameters and Processes

Atmospheric parameters and conditions, such as air entry and the oxygen supply, will impact weathering conditions of sulphidic geologic materials and therefore the drainage chemistry. The primary restriction on the rate of oxygen supply in an open pit will be the height of standing water.

Air movement in an underground mine will be reduced when air pumps are shut-off after active mining is completed. Air movement would then result from differences in temperature, barometric pressure and fluctuations in the height of flooding and may be increased by surface subsidence. Restrictions to the oxygen supply in underground workings include:

- flooding;
- low conductivity of backfill or talus created by mass wasting; and
- oxygen consumption by processes such as sulphide oxidation and organic matter decomposition.

Temperatures within the walls of an open pit will depend on the overlying air temperature and will vary seasonally. Temperatures within underground workings will be similar to ground temperatures and there will be minimal seasonal variation unless there is significant air flow from the surface. Elevated temperatures may occur within underground workings due to the depth of mining and sulphide oxidation. Sulphide oxidation has caused fires in massive sulphide and coal mines.

### 7.3 Waste Materials

At most mines with sulphidic geologic materials and a drainage chemistry concern, the commodity that is sold is a very small portion of what is mined. Most of the excavated material is waste. The typically large volume and mass render transport of waste prohibitively expensive. Thus, waste removal from the site only occurs in rare instances when some form of commercial use for the waste can be found. Most mine wastes remain on the site after mining and consequently most mine sites are waste storage facilities.

*At most mines with sulphidic geologic materials and a drainage chemistry concern, the commodity that is sold is a very small portion of what is mined. Most of the excavated material is waste.*

The types, masses and composition of the wastes will depend on the:

- location and dimensions of the ore body;
- original physical and geochemical properties of the bedrock;
- amendments;
- stripping ratio for an open pit; and
- methods of excavation, processing, transportation, rehandling, secondary treatment, deposition and any temporary stockpiling.

The methods listed in the last bullet can have a large effect on the potential drainage chemistry and environmental protection costs. Consequently, mines must consider the potential drainage chemistry when planning how wastes will be excavated, processed and deposited. The wide variety of geologic materials and methods for mining, processing, reworking and deposition result in a wide variety of waste materials that may cause concern with respect to drainage chemistry.

The waste materials with the largest mass and volume and covering the largest area are often the tailings and waste rock. Tailings are the ground rock waste product from a mill or process plant; the materials remaining after the saleable products are removed from the ore. The tailings usually leave the mill as a slurry of sand and/or silt sized particles in water. Tailings are commonly stored in a surface impoundment, but in some cases it may be placed sub-aqueously in natural water bodies or backfilled into underground workings (Section 7.2).

Waste rock is the portion of excavated rock with insufficient amounts of the saleable product to warrant its processing, but which has to be removed to allow physical access to the ore. Waste rock is typically broken up by blasting into sufficiently small particles to allow its removal by truck and shovel. Disposal occurs in dumps or as backfill into open pits or underground workings. In coal mining, waste rock may be referred to as “spoils”, “gob”, or “rejects”, terms

which can also apply to waste materials from the density separation and the wash plant. The amount of waste rock and waste non-lithified overburden that must be excavated to extract a unit amount of ore or coal is called the stripping ratio.

Open pit mines typically produce large quantities of both tailings and waste rock. Underground mines typically have a much higher ratio of ore to waste and produce far more tailings than waste rock. Depending on the depth and the lateral dimensions of the mine, topsoil and other types of surficial non-lithified overburden removed during the initial phase of open pit construction may be another large waste product. Other potential waste products include: low grade ore, quarry and borrow pit materials, waste products from effluent treatment and residues of other processing methods such as spent heap leach piles and roaster residues.

*Open pit mines typically produce large quantities of both tailings and waste rock.*

A list of waste materials and potential products of their segregation and reworking is provided below.

- Waste Rock:
  - Segregation of different particle sizes on long slopes;
  - Crushed for use in road construction or as a filter material between waste rock and finer materials (Huckleberry Mine in British Columbia); and
  - Cyclone crushed material, the sand fraction of which is used in construction or as backfill (Snip Mine in British Columbia) (Price, 2005).
- Tailings:
  - Removal of targeted minerals and elements and addition of water and various process chemicals during processing or milling;
  - Spatial segregation of tailings sand and finer material (slimes) on a beach with tailings slimes migrating down gradient;
  - Cycloned into tailings sand and tailings slimes, the sand fraction is used in construction (Kemess Mine) or as backfill (Snip Mine) (Price, 2005);
  - Desulphurization by flotation into lower sulphide tailings;
  - Thickened to form paste tailings for disposal or use as backfill; and
  - Added cement to form cemented paste tailings for use as backfill.
- Low Grade Ore:
- Residue of Other Processing Methods:
  - Spent heap leach piles; and
  - Roaster residues.
- Quarry Materials:
  - Same options for segregation and reworking as waste rock.
- Topsoil and Other Non-Lithified Overburden (Borrow Materials):
  - Sieve and use desired particle size fraction as aggregate.
- Waste Products from Effluent Treatment:
  - Lime treatment sludge;
  - Ferric sulphate treatment sludge; and
  - Residues from biological treatment.

Blasting powders, gels and emulsions may add nitrogen residues to mine wastes created by blasting.

## 7.4 Waste Rock

Waste rock is bedrock with insufficient amounts of the economically valuable commodity to warrant processing, but which has to be removed to allow physical access to the ore underneath. In heap leaching, spent ore is sometimes referred to as waste rock.

Waste rock is commonly broken by blasting. Waste rock disposal occurs in subaerial or subaqueous dumps and may include backfill into open pits or underground workings (Section 7.2). In most hard rock open pit mines, shovels load the blasted waste rock into trucks that move it to the disposal location. In underground mines, scoop trams remove the blasted waste rock and take it directly to exhausted headings or other dump locations. Bulldozers are often used in waste rock dump construction, pushing waste rock over the advancing dump face, reducing dump slopes or moving it into some other planned location on the dump. Drag lines are used to remove blasted waste rock and backfill it into the previous workings at strip coal mines. Conveyors are also sometimes used to move wastes.

*Waste rock disposal occurs in sub-aerial or subaqueous dumps and may include backfill into open pits or underground workings.*

The following factors should be considered when predicting the future drainage chemistry from a waste rock dump:

- physical and geochemical properties of the original rock;
- excavation methods and the physical and geochemical properties of the resulting waste rock;
- dump construction methods, dimensions, drainage inputs and the segregation of different sized particles;
- age of the dump and the amount of time that may be required for waste rock to accumulate water to exceed field capacity and for the drainage to emerge at the base of a dump; and
- mitigation measures.

### 7.4.1 Particle Size

Particles in waste rock range from boulder- and cobble-sized coarse fragments to clay-sized ( $< 2 \mu\text{m}$ ) grains. Particle size distribution contributes to mineral exposure, particle surface area and rate of leaching. The proportion of different sized particles depends on the:

- strength of the rock;
- procedures used to blast, remove, rehandle and dispose of the waste rock;
- surface traffic;
- susceptibility of the rock to weathering; and
- time of exposure and weathering conditions.

Waste rock is typically blasted into small enough particles to allow its removal, a large proportion of the mass consists of coarse fragments. The maximum particle size of waste rock from an open pit using very large equipment may be boulders several meters in diameter. Due to the smaller size of the workings and equipment, the maximum diameter of waste rock from an underground mine is usually much smaller (e.g.  $< 50 \text{ cm}$ ).

Measurement of the proportion of different sized particles in waste rock from open pit mines is

*Measurement of the proportion of different sized particles in waste rock from open pit mines is hampered by the size and weight and therefore the difficulty of sieving larger particles.*

hampered by the size and weight and therefore the difficulty of sieving larger particles. However, even when sampling is restricted to the top of a dump bench and particles small enough to fit in a 20 liter pail or 45 gallon drum, typically only 5 to 40% of the mass of waste rock from metal mines is < 2 mm in diameter (McKeown et al., 2000).

At the Whistle project in Ontario (K. De Vos, personal communication) and at the Kitsault mine (McLaren, 1986) less than 3% of the entire waste rock mass was estimated to occur in the < 2 mm particle size fraction. These two sites are likely typical of competent, indurated rock types found at precious and base metal mines (Price and Kwong, 1997).

The proportion of fine sized particles will vary depending on the strength and durability of the rock. Various weathering studies have observed that fine grained rock produce a lower portion of particles < 2 mm than coarser grained rock (Birkeland, 1974; Carroll, 1970). For example, samples taken from waste rock benches of fine grained hornfels and volcanic rock have a lower average percentage of fine particles than from those of coarser grained granite (e.g. 20% compared to 30% < 2 mm particles) at the Kitsault mine (Price, 1989). One potential reason for a lower portion of finer particles in waste rock from fine grained rock is that the intergranular surface area increases with a decrease in grain size; hence more energy is required to disaggregate the fine grained rock, and the cohesive interlocking is a barrier to water and other weathering agents (Birkeland, 1974).

The proportion of particles < 2 mm in samples from a dump bench may exceed 40% if the rock is exceptionally weak or rapidly weathering (e.g. little cohesion between mineral grains). Examples of weak, rapidly weathering rock include fine grained coal shales (Younger et al., 2002) and waste rock with high concentrations of sericitic clay at metal mines (e.g. Kitsault Mine in British Columbia (Price and Lavkulich, 1988) and Mine Doyon in Quebec (Choquette and Gélinas, 1994)).

The majority of the < 2 mm particles in waste rock is typically sand sized, with lesser silt sized and only a small proportion of clay sized particles. The relative proportion of the < 2 mm particles that are silt and clay sized increases where the rock types are fine grained (e.g. sericitic, shale, hornfels and volcanic rock) and weathered.

#### **7.4.2 Particle and Mineral Surface Area Exposed to Weathering**

The particle surface area of waste rock will depend on the proportion of small sized particles and the particle shape. There can be an exponential increase in surface area per unit mass with a decrease in particle size (Birkeland, 1974). Thus, although coarse fragments can comprise most of the mass (Section 7.4.1), they have relatively little surface area. Also, mineral grains in coarse fragments are almost entirely occluded from oxygen and water and thus are relatively inert and contribute relatively little to drainage chemistry. Therefore, the majority of the surface area and consequently, the majority of weathering will likely occur in the smaller particle size fractions and in the regions and layers of a dump containing the majority of the small particles.

Other properties and processes that may increase the surface area and the relative rates of weathering of the finer grained waste rock are as follows:

- smaller particles are more likely to be plate-like resulting in a greater surface area per unit of diameter than the cube- and sphere-like shapes that predominate in coarser fragments; and,
- the residence time for leachate is likely to be longer in a matrix of smaller particles, resulting in greater dissolution of weathering products.

For example, carbonate minerals were removed by weathering from the < 2 mm sized particles, but not in the 2 to 11 mm size fraction, from a range of intrusive and volcanic waste rock samples with a rinse pH less than 4.5 (Price and Kwong, 1997). This suggested that the < 2 mm was the particle size fraction affecting or reflecting drainage chemistry.

### 7.4.3 Differences between the Geochemistry of the Fine and Coarse Sized Particles

The reactivity of waste rock will depend in part on the concentration of reactive minerals in different sized particles. Mineral grains occurring in more cohesive, stronger regions of the bedrock are likely to preferentially report to the coarse fragments. Mineral grains occurring along fractures or planes of weakness and with weak inter-grain cohesion will report preferentially to the small percentage of finer particles. Coarse particles are the majority of the mass, and bedrock samples are likely to closely match their composition. Small sized particles are typically only a small portion of the mass and their geochemical composition may deviate widely from the composition of coarse fragments and the mass of waste rock as a whole (Table 7.2).

**Table 7.2 Average ABA results for > and < 2 mm fractions in waste rock from a metal mine.**

	< 2 mm	> 2 mm	< 2 mm / > 2 mm
AP (kg/t)	257	86	3.0
Sobek NP (kg/t)	44	32	1.4
CO <sub>3</sub> -NP (kg/t)	37	13	2.8

### 7.4.4 Dump Construction and the Resulting Structural Features

The construction methods, dimension and location of a dump will affect the physical, geochemical and hydrologic properties of the dump, such as particle size segregation and the spatial distribution of structural features (Morin et al., 1991; Smith and Beckie, 2003). The main methods for transporting waste rock to the dump are by truck, truck and dozer, conveyor or drag line. Disposal costs are often reduced by dumping waste rock close to and downhill of the excavation site or the active mining workings.

*The construction methods, dimension and location of a dump will affect the physical, geochemical and hydrologic properties of the dump.*

In the free dumping and drag-line spoiling methods of dump construction, trucks and drag-lines, respectively dump contiguous piles of waste rock. The piles may then be dozed flat creating a bench that becomes the disposal site for another series of piles. With free dumping, the bench is approximately 2 m high. In drag-line spoiling, piles may be considerably higher, but there is

typically only one bench. There is little particle size segregation in free dumping and drag-line spoiling. In free dumping, there may be some abrasion and compaction by truck traffic on bench surfaces. The lateral and vertical differences in the composition of free dumps and drag-line spoils primarily result from differences in the composition of the original geologic materials.

The most common method of dump construction is by end-dumping or push-dumping waste rock over the face of an advancing terrace dump, where to varying degrees it spreads from crest to toe. In end-dumping, trucks or a conveyor directly dump(s) the waste rock onto the slope. In push-dumping, waste rock is dumped in piles near the crest and then pushed over the advancing dump slope by a dozer.

Structural components resulting from a single bench of end-dumping and push-dumping include:

- layering parallel to the angle of repose;
- horizontal traffic surfaces on the surface of the dump bench; and
- fines rich waste rock near the top and fines poor waste rock at the bottom of a long slope due to vertical particle size segregation.

Construction of new benches, lateral extensions that wrap around older dumps and ongoing weathering (Section 7.4.5) will also affect the physical, geochemical and hydrologic properties of a dump. They would greatly complicate the layering created by a single bench.

Differences in the original particle size distribution and particle size segregation of the waste rock dumped on slopes will result in layers with different particle size distributions parallel to the angle of the slope. The length and depth of the layers will depend on the height of the dump and the heterogeneity of the waste rock.

Vehicle movement, especially truck traffic, during dump construction may create compacted layers and increase particle abrasion on the surface of dump benches. The location and number of traffic surfaces will depend on the location and number of benches. The effect of abrasion and compaction will depend on the type and density of the traffic during dump creation and the physical properties of the waste rock.

*Vehicle movement, especially truck traffic, during dump construction may create compacted layers and increase particle abrasion on the surface of dump benches.*

Vertical gravimetric particle size segregation during end-dumping and push-dumping on long slopes typically produces a fines rich layer at the top, and fines poor layer at the bottom of that bench. Coarse fragments in waste rock end-dumped or push-dumped onto a long slope are distributed over the entire slope length, but are preferentially deposited on the lower slopes and at the toe.

The minimum slope length and bench height for gravimetric particle size segregation and the length of the fines rich layer at the top of the slope will depend on the mode of deposition, particle size distribution and grading of the waste rock, but is typically 10 to 20 m. The greater velocity of waste rock particles end-dumped will tend to increase the distance smaller particles

move down the dump face relative to push-dumping. A higher concentration of smaller particles will result in a longer fines rich layer.

During initial deposition and compaction of the dump by vehicle traffic during construction, smaller particles at the bottom of the fines rich layer falling into gaps between underlying coarser fragments may migrate into the underlying fines poor layer. Collisions, as coarse fragments bounce down the slope, will produce small particles along the entire length of the slope, but especially along the fines poor layer at the bottom.

#### 7.4.5 Particle Breakdown and Migration after Dump Construction

Surface area, particle size and particle size distribution are not static properties. Over time, physical and chemical weathering will fracture and break waste rock particles resulting in particle size reduction. Dump settling and entrainment by drainage will result in the downward migration of smaller particles. Potential impacts of reducing the size of existing particles, creating new, smaller particles and particle migration include:

*Surface area, particle size and the particle size distribution are not static properties.*

- increasing the overall particle surface area;
- exposing unweathered surfaces of mineral grains to weathering; and
- changing drainage and weathering conditions.

Reduction in particle size may cause dumps to settle, change drainage paths and the rate of leaching, increase the degree of saturation and change the geochemical composition of the smaller particles whose weathering determines the drainage chemistry. This process, however, may take several decades before a measurable impact in system behaviour is observed.

Particle migration due to washing of fines into voids may change the particle size distribution in different areas of a waste rock dump. Potential changes include:

- infiltrating drainage or wind erosion removing smaller particles, creating a “stone pavement” on the dump surface (Price, 1989); and
- downward movement of smaller particles by drainage and surface weathering of coarse fragments, increasing the concentration of smaller particles in the fines poor layer at the bottom of a bench.

The rate of particle breakdown and migration will depend on the dump structure, physical strength of the rock, content of reactive minerals, depth within the pile and climate conditions.

Changes in particle size, creation of new fines, exposure of fresh mineral grains and replenishment of rapidly weathering minerals may alter the composition of the fine fraction and delay mineral depletion and changes in drainage chemistry from that predicted from the initial geochemical composition of the fine particles. For example, particle breakdown may continually replenish the supply of neutralizing minerals such as calcite, maintaining neutral pH drainage for far longer than that predicted from the rate of depletion and neutralization potential initially measured in the reactive fines. Continual exposure of fresh sulphide grains could increase



sulphide oxidation rates. The relative rates of exposure of acid generating and neutralizing minerals may alter their ratio and the resulting drainage chemistry.

There is little quantitative information about particle breakage and migration and their impact on the physical, hydrological and geochemical properties of a dump. Although future fracturing and breaking of particles may impact properties and processes contributing to drainage chemistry, the rate and impact of these processes are typically not investigated in the prediction of drainage chemistry.

#### 7.4.6 Hydrologic Properties and Drainage Conditions

The hydrologic processes in mine waste rock are described by Morin et al. (1991) and Smith and Beckie (2003). The main properties and processes controlling the rate and location of water movement in waste rock and the proportion and spatial distribution of zones with different drainage conditions are the:

- rate and location of infiltration;
- moisture content;
- particle size distribution;
- hydraulic conductivity; and
- absorptive and capillary forces (matric potential).

The particle size distribution determines the size and shape of pores, which in turn determines the hydraulic conductivity and matric potential at different moisture contents. Drainage conditions within a dump will be a function of the rate and location of infiltration and the proportion and spatial distribution of zones of waste rock with different hydraulic conductivities and matric potentials. Potential drainage inputs include the infiltration of snow melt and rainfall through the surface and along the batters, as well as additions of runoff and groundwater along the edge and bottom of the dump.

Due to the large proportion of coarse fragments, waste rock typically has a high infiltration rate and hydraulic conductivity. Factors resulting in reduced infiltration, increased runoff, flooded conditions or a perched water table within at least a portion of the dump include the following:

- the dump is located in a flooded impoundment, water body or area of drainage discharge;
- the waste rock is predominantly soil like, with relatively small particles and pores;
- deposition results in compacted traffic surfaces;
- the precipitation of weathering products creates a cemented layer or layers beneath or within a dump; and
- ice layers occur or form beneath or within a dump.

Waste rock can behave in a matrix supported or matrix free manner. In the matrix free zones there

*Waste rock dumps can be grouped into two categories. Matrix free dumps contain coarse rock fragments in contact with each other and water can flow through macropores. Matrix supported dumps contain smaller particles in which coarse particles are distributed which affects water movement.*

is point to point contact between coarse rock fragments and flow occurs mainly in macropores. In matrix supported waste rock, where stones and boulders float in a matrix of smaller particles,

flow occurs predominantly in the finer grained matrix materials and the hydraulic properties reflect the grain size of the matrix. As a first approximation, the transition between the two behaviours occurs at approximately 20% particles finer than 2 to 4.75 mm (Smith and Beckie, 2003).

Matrix supported zones will have suction and will be the zones for water movement under low moisture content conditions. During snow melt and high rainfall events resulting in high moisture contents, leaching may occur as water flows around rocks in zones of coarser material. The heterogeneous spatial distribution of zones with different particle sizes and conductivity, both lateral and vertically, will result in flow paths having different combinations and proportions of matrix supported or matrix free flow. Different flow paths will also be activated by different infiltration (rainfall) rates. Traffic surfaces and large coarse fragments may impede downward infiltration and focus flow into preferred pathways.

The percolating drainage will be a combination of water that passes through rapidly (hours) and water that drains more slowly (weeks to years). Research on a 5 m high hard rock test pile (Nichol et al., 2005) showed that the drainage moving through fast flow paths, with residence times of 5 to 10 hours, was 5 to 8% of the flow on average and a maximum of 15% at peak infiltration. The average residence time of drainage infiltrating through the experimental piles was approximately three years, indicating that:

- even under relatively high infiltration conditions, significant portions of most flow paths were through matrix supported material; and,
- most of the new water infiltrating into the test pile displaced old water along flow paths.

To date, there is no definitive assessment of the proportion of active leaching in a waste rock

*To date, there is no definitive assessment of the proportion of active leaching in a waste rock dump.*

dump. Older work indicated that less than 25% of an exposed, “free-draining” dump would be actively leached by incident precipitation (Morin et al. 1991). Recent research on waste piles where matrix flow dominated suggested that more than 25% was actively

leached (Nichol et al., 2005). Weathering products will accumulate in the hydraulically isolated areas of the pile. Leaching of hydraulically isolated areas may occur due to high precipitation or a rising water table or if dump settlement, particle breakdown, precipitate formation or particle migration divert existing flow paths. The temporal variation in loading at the base of a pile may also represent varying degrees of flushing of matrix pores at different moisture contents.

Waste rock may be placed in a dump with 3 – 5% moisture content. At each depth, there will be a water accumulation phase until the matrix materials reach field capacity, at which point downward drainage occurs into the underlying rock. Typical values of field capacity are 8 – 10%. It could take from several years to many decades for the water accumulation phase to terminate and for a dynamic equilibrium of seasonal responses to be established. When infiltration exceeds discharge, loading is reduced.

### 7.4.7 Atmospheric Properties and Processes

The rate of air flow and oxygen supply in a waste rock dump will depend on properties that control the air permeability and drive air movement, such as the particle size distribution, structure, water content, composition of the gas phase, temperature and the dump dimensions or geometry (Morin et al., 1991). The principal mechanism of air movement and oxygen supply in a waste rock pile where a large proportion of the mass consists of coarse fragments is advection. Advection can move air (and oxygen) to great depths in the pile. Where a waste rock dump is in a well drained location, although both gaseous and liquid phases will be present in the pore space, the coarseness of waste rock will generally result in high porosity and rapid convective air movement. Oxygen transfer by diffusion is an important mechanism in fine textured or compacted layers lacking large, interconnected voids.

Sulphide oxidation and other weathering reactions may reduce the oxygen concentration and increase the concentration of other gases compared to atmospheric conditions, making the dump atmosphere a human health hazard (e.g. Phillip and Hockley, 2007). However, in the absence of a major oxygen barrier or sink, the rate of convective air flow will be sufficient to maintain oxygenated conditions and aerobic weathering conditions throughout most of a coarser waste rock dump. In this case, the drainage chemistry and loadings from a waste rock dump will be limited by the geochemical composition, solubility constraints and the rate and location of leaching, rather than the rate of oxygen supply to sulphide oxidation.

Potential oxygen barriers or sinks that may influence drainage chemistry include:

- site conditions or dams that cause flooding; and
- high drainage inputs coupled with low pore size due to a fine texture and/or compaction results in an elevated water table.

The coarser and more permeable the waste rock material, the greater is the potential for

*In well drained dumps, inclined, high permeability channels (“chimneys”), produced by end- or push-dumping of coarse waste rock, can be pathways for high rates of air movement and increase air flow.*

advective air movement (Ritchie, 2003). In well drained dumps, inclined, high permeability channels (“chimneys”) produced by end- or push-dumping coarse waste rock can be pathways for high rates of air movement and increase

air flow. Horizontal, compacted traffic surfaces with lower permeability may limit air movement.

Temperature within a waste rock dump will depend on the:

- rate of heat production by sulphide oxidation;
- heat inputs from overlying air, underlying ground and infiltrating drainage; and
- heat losses.

High rates of sulphide oxidation due to high rates of air entry may result in temperatures exceeding 40°C and in some instances exceeding 60°C. There is also an important feedback mechanism; higher temperatures increase advective air circulation, which can enhance the rate of sulphide oxidation. High temperatures may melt snow, kill vegetation and in some instances, especially with coal, the dump may catch fire.

Dump temperatures will also depend in part on the depth of the dump. Seasonal decreases or increases in the overlying air temperature will have a much greater influence on temperatures near the surface. The usual depth range of effect is 8 – 10 m. Even a permanently frozen dump will have an active layer that melts during periods of the year. Temperatures deep within a dump will be less affected by seasonal variation and will remain relatively constant throughout the year.

Seasonal changes in the oxygen concentrations within a dump may result from seasonal changes to air entry due to a snow cover or changes in overlying air temperatures.

Air movement will vary in different regions of a dump. In addition to the windward side, greater air entry typically occurs along the upper sides and adjacent upper surface of a dump. The geometry of a dump will impact air entry and where cells of air circulation can develop. The greater the height to width ratio of the dump, the greater is the potential for advective air movement (Ritchie, 2003).

#### 7.4.8 Weathering and Contaminant Migration

The geochemical properties and conditions within a waste rock pile, such as the type and rate of weathering processes and contaminant migration, will depend on the:

- geochemical composition;
- oxygen supply;
- surface area;
- temperature; and
- chemistry of drainage inputs.

The geochemical composition of waste rock will depend on the geochemistry of the contributing rock types in the bedrock. The presence of different geologic materials may result in regions of a dump having different physical and geochemical properties and therefore different rates of weathering and leaching. Differences in the percentage of finer particles and weathering may also affect the contribution of rock types to drainage chemistry relative to their volumes or mass.

Although both gaseous and liquid phases will be present in the pore space, due to the large size of the voids, aerobic weathering conditions will generally occur throughout a coarser waste rock dump. However, the rate of oxygen supply will differ depending on the structure and particle size of the waste rock, the geometry of the dump and the location within the dump. Differences in geochemical composition, surface area and rate of air supply to the fines versus the coarse fragments may result in different weathering rates due to vertical particle segregation, layering parallel to the angle of repose and traffic surfaces.

The large ratio of solid to leachate in a waste rock dump will typically result in the concentrations

*The large ratio of solid to leachate in a waste rock dump will typically result in the concentrations of some species in solution reaching solubility limits and then precipitating as secondary minerals and amorphous materials.*

of some species in solution reaching solubility limits and then precipitating as secondary minerals and amorphous materials. The

recurring precipitation of weathering products will increase the magnitude of future loadings if there is an increase in drainage volume leaching the waste rock.

Fluctuations in annual solute loading from a waste rock dump can be explained by the mass balance of the solutes along flow paths. For example, solutes can precipitate and accumulate during years with below average leaching events and then redissolve during periodic, high flushing events (Morin and Hutt, 2004).

The rate of waste rock weathering will depend on a number of factors and, unlike tailings (Section 7.5), may not necessarily be highest at the surface. Factors that may lead to greater NP depletion and higher rates of sulphide oxidation in “hot spots” in pockets of waste rock below the surface include:

- higher concentrations of acid producing sulphide minerals or lower concentrations of neutralizing minerals; and
- isolation from seasonal decreases in external air temperatures, higher heat retention and high rates of oxygen supply within the dump.

Reasons for the rate of waste rock weathering being highest at the surface and progressively moving deeper include:

- incident precipitation and other surface inputs deplete neutralizing minerals; and
- alkalinity produced by weathering slows depletion of neutralizing minerals in the underlying materials.

Acidity in incident precipitation and from the partial decomposition of organic matter may contribute to the surficial consumption of neutralization. This may result in the initiation of acidic weathering conditions at the surface and progressive migration deeper into the dump. The failure of alkaline water to drain hydraulically isolated areas of the dump may contribute to the development of “hot spots”.

Typically, groundwater contains alkalinity and slows the depletion of neutralizing minerals. However, the inflow of acidic groundwater may accelerate the depletion of basal neutralizing minerals, resulting in the most advanced mineral weathering and lowest rinse pH values in the zone of fluctuating groundwater at the base of a dump (Price, 2005).

## **7.5 Milling or Processing Wastes**

Milling or processing refers to the activities involved in the recovery and concentration of valuable commodities prior to shipment to a direct consumer, smelter or refinery. Processing methods will depend on the commodity, its mineralogy and whether it is encapsulated or attached to other minerals. Common processing activities include: screening, crushing, grinding, classification, specific gravity separation, magnetic concentration, washing, flotation, cyanidation, calcination, roasting and dewatering.

### 7.5.1 Reducing the Particle Size

Data from individual descriptions of geologic materials should be used to describe the central tendency, variability and spatial distribution of properties and the locations and descriptions for each geological unit. Variability is an important consideration in the segregation of different materials and in ensuring that all potential outcomes in drainage chemistry are predicted. Information on the variability of different analytical properties may also indicate whether additional sub-division and segregation of rock types is needed or is practical.

Crushing, or crushing followed by grinding, to reduce the particle size is commonly the first step in processing blasted ore or coal particles. The objective in reducing the particle size is to release coal or mineral grains or to expose metal or mineral surfaces. The intended degree of the particle size reduction will depend on the:

*Crushing, or crushing followed by grinding, to reduce the particle size is commonly the first step in processing blasted ore or coal particles.*

- type and grain size of the economic materials or minerals; and
- the processing methods.

Crushing reduces the particle size by squeezing or forcing it under pressure. Crushing methods include: gyratory, jaw, roll and cone crushers. A jaw crusher reduces the particle size to approximately < 51 mm (2 inches).

Grinding further reduces the size of crushed particles through impact or attrition. Methods include grinding in rod and ball mills and autogenous and semi-autogenous grinding. Grinding reduces the blasted ore or coal to sand sized (50  $\mu\text{m}$  to 2 mm) and/or silt sized (2  $\mu\text{m}$  to 50  $\mu\text{m}$ ) particles. The waste product from grinding is called tailings.

On a large scale, grinding is typically achieved in a rotating cylinder. A ball or rod mill is a cylindrical or conical shaped steel container which is partially filled with steel balls or rods and the crushed ore. Rotation causes the balls to cascade, which in turn grinds the ore. In autogenous grinding, large pieces of the ore itself is used as a grinding media instead of conventional steel balls or rods. In semi-autogenous grinding (SAG), the grinding media includes both the larger chunks of the ore and steel balls or rods.

A classifier is often used after crushing and grinding to separate particles according to size and density, including grizzlies, screens, cyclones and other mechanical devices.

### 7.5.2 Processing Coal

In coal preparation facilities, such as a coal wash plant or cleaner, saleable coal is separated from impurities by screening, reducing the particle size and specific gravity differences using methods such as heavy media separation. After cleaning, the coal is typically dried. Waste byproducts of a wash plant include coarse and fine (tailings) refuse.

### 7.5.3 Processing Ore

There are a large number of processing methods. One of the simplest forms of processing is basic crushing with a jaw crusher followed by gravity separation used to recover directly refineable precious metals. More commonly, crushing and grinding are followed by surface reaction processes such as cyanidation and flotation to produce a concentrate enriched in the valuable metal or mineral relative to the ore. Roasting and calcination may be used to liberate encapsulated or attached gold particles in refractory ores or concentrates.

Flotation processes use surface active chemicals to selectively modify surfaces causing the target

*In some instances, sulphide flotation is used to reduce the ARD potential of the rougher tailings, allowing separate disposal or mitigation of sulphide-rich cleaner tailings.*

mineral to become attached to air bubbles and float, separating them from the waste which sinks. The choice of flotation processes and reagents will depend on the composition of the ore and the desired concentrate.

Flotation circuits may be divided into rougher, scavenger and cleaner stages. The rougher stage is a term applied to the initial phase(s) of concentration and recovery. In addition to the initial mill feed, the rougher stage may also include scavenger concentrate or cleaner tailings. The distinction of rougher tailings suggests that further more refined processing is carried out, potentially resulting in other tailings and/or a higher grade concentrate. Typically, most of the tailings mass is produced in the rougher stage. In some instances, sulphide flotation is used to reduce the ARD potential of the rougher tailings, allowing separate disposal or mitigation of sulphide-rich cleaner tailings.

The cleaner stage occurs after the rougher stage and is used to upgrade the concentrate produced in the rougher and scavenger circuits. Cleaner tailings are often sulphide rich and have a higher ARD potential than tailings produced by other stages of flotation.

The scavenger stage is the last phase of recovery of the valuable material. The scavenger concentrate may be fed back into previous stages of flotation.

Cyanidation or cyanide leaching dissolves gold or silver in a weak solution of sodium or calcium cyanide. Cyanidation is a common extraction method when gold or silver grains are exposed after crushing and grinding the ore and may be conducted inside a mill or in heaps of ore outdoors.

Roasting or calcination is used as a pretreatment stage before cyanide leaching of refractory ores or concentrate containing sulphur and/or arsenic, antimony, tellurium and carbonaceous material to liberate encapsulated or attached gold particles. Examples of calcining include: the decomposition of hydrates such as ferric hydroxide to ferric oxide and water vapor; or calcium carbonate to calcium oxide and carbon dioxide.

The main reactions of roasting are the oxidation of pyrite and arsenopyrite to form sulphur dioxide gas and solid metal oxide. The solid product from roasting is often called “calcine”. In “selective roasting”, temperature and gas conditions are maintained so that one metal forms a sulphate and the other forms an oxide. Pollution prevention equipment may be required to collect gaseous and fine particulate sulphur and trace elements expelled in the roaster gas.

Heap leaching is an extraction process in which solutions are percolated through heaps of stockpiled ore to remove target metals from low grade ores. Acids or alkaline cyanide are generally used to leach base metals and precious metals, respectively. In bioleaching, the target species are dissolved with the aid of bacteria. Leachate may be recirculated a number of times through the heap to increase the concentration of the targeted metals. The post-blast particle size of the ore to be leached may be reduced to increase surface exposure of the target mineral(s).

Metals contained in the leachate from a heap leach may be extracted chemically or electrochemically. In electrolytical processes, an electric current passed through a leachate solution containing high concentrations of dissolved metals causes the metals to be deposited on a cathode.

Despite a potential reduction in particle size, a heap usually contains coarse fragments and is aerated and leached relatively rapidly, properties that it has in common with a waste rock dump. By removing the targeted metals and other components, leaching solutions may alter the composition of the ore and the future drainage chemistry. For example, acid leaching removes soluble neutralizing minerals and will lower the NPR, increasing the potential that the post-closure drainage will be acidic.

Further processing of processing products, such as concentrates, may be needed to remove penalty elements which would produce additional process wastes. Examples of further processing to remove penalty elements are leach plants that remove arsenic.

#### 7.5.4 Properties of Processing Wastes

Different processing methods produce waste products with different properties and small changes to processing methods may have profound effects on the physical, geochemical and drainage properties and the future drainage chemistry. The physical, geochemical and drainage properties and the future drainage chemistry of processing wastes depend on the:

- original composition of the ore;
- reduction in particle size;
- chemicals added;
- water added;
- material extracted; and
- geochemical changes to original components.

An important consideration is the oxidation of sulphide minerals and precipitation of secondary minerals prior to or during processing. Processing methods may be modified for oxidized ore. Roasting and calcining products are oxidized and therefore have very different geochemical properties than unoxidized sulphide wastes. Oxidation of sulphide minerals by prior weathering or roasting may markedly increase the solubility of some trace elements at near-neutral pH or may increase their susceptibility to reductive dissolution.

*An important consideration is the oxidation of sulphide minerals and precipitation of secondary minerals prior to or during processing.*



Changes in particle size will affect drainage conditions, air entry and mineral exposure. Chemical additions may alter the neutralizing potential and create new or increase the concentration of the existing chemical species of concern. For example, the addition of lime will increase the pH and increase the neutralizing potential of the tailings. The amount of increase in the neutralizing potential will depend on how much lime is added. It is therefore very important to keep track of chemicals added and consider the impact of any changes on the predicted drainage chemistry.

## 7.6 Tailings

Tailings are the waste product remaining from the ore after several steps of particle size reduction and extraction or washing to remove the valuable commodity. The following factors should be considered when predicting the composition and

*Tailings are the waste product remaining from the ore after several steps of particle size reduction and extraction or washing to remove the valuable commodity.*

future drainage chemistry from tailings:

- physical and geochemical properties of the ore;
- mill processing methods, including the particle size reduction, amendments and extracted components;
- any additional processing to enable a certain type of disposal, use as backfill or for construction such as dewatering;
- chemical composition of process water;
- method of deposition, disposal location, site dimensions, drainage inputs and the segregation of different sized particles; and
- mitigation measures.

Additional processing to enable a certain type of disposal, use as backfill, or for construction can include:

- dewatering;
- cycloning;
- desulphurization; and
- effluent treatment.

### 7.6.1 Particle Size and Geochemical Composition

The physical and geochemical composition of the tailings will depend on the composition of the ore and the reduction in particle size, amendments and components removed during processing. In order to expose economic minerals to the process chemicals, the ore is reduced to sand sized and/or silt sized, and tailings particles are typically between 10  $\mu\text{m}$  and 1 mm.

Amendments are usually small amounts of process reagents. Potentially important process reagents include additions of alkalinity that will increase the NP, and metal bearing reagents like copper sulphate which may increase metal leaching.

Although it will vary with the process and ore, usually only a small portion of the ore is removed during processing. The proportion of original mass of the ore that reports as tailings is often more than 95% of the original mass.

Commonly, sulphide minerals containing the trace elements considered the primary

*Commonly, sulphide minerals containing the trace elements considered the primary contaminants of concern are also the economic minerals that are the target of processing.*

contaminants of concern are also the economic minerals that are the target of processing. Therefore, for the prediction of future tailings drainage

chemistry, important questions are the degree of removal of sulphide minerals containing the contaminants of concern and the acid generating potential remaining in the tailings. Although lower than the concentrations in the ore, the economic minerals are likely to remain at significant levels in the tailings due to inefficiencies in the removal process.

Although only a small portion of the ore is removed during processing, the portion removed may contain a sufficiently high portion of the sulphide minerals to alter the acid generating potential and lower the potential for deleterious drainage from the remaining tailings. Slight changes in the amount of processing reagents may have a large impact on iron sulphide removal and the acid generating potential of the tailings. It is therefore very important to keep track of processing methods and to predict the impact of any changes in processing methods on the geochemical composition of the tailings and the future drainage chemistry.

Different processing stages can produce geochemically different tailings (Section 7.5.3). The variability in the geochemical composition of the tailings solids and the drainage chemistry from the tailings as a whole will depend on whether tailings from different processing stages are recombined or discharged individually.

### 7.6.2 Process Water

The composition of the process water will depend on the processing reagents and the solubility of ore minerals and products of the rock abrasion.

*The composition of the process water will depend on the processing reagents and the solubility of ore minerals and products of the rock abrasion.*

The addition of metal bearing reagents, like copper sulphate, during processing can increase metal concentrations. Process water typically has a neutral or alkaline pH due to the required pH of the process or the alkalinity produced by crushing and grinding the ore. Alkaline reagents like lime may further raise the slurry pH and increase the neutralizing potential of the tailings.

During active processing, process water may be reused and in this case impoundment structures will increase in size to minimize discharge to the environment. During active mining, this recirculation and reuse of process water may cause aqueous concentrations of elements to increase, including those of nitrogen species derived from ammonia nitrate used in blasting. As a result, treatment of water may be needed during active mining to reduce concentrations of potentially deleterious species. Depending on the water quality at closure, the water may require additional or ongoing treatment.

Some sulphide oxidation may occur in the feed, grinding, aeration and flotation circuits during the milling of sulphidic ores. Typically, the amount of oxidation is small and the product is sulphate. However, in sulphide-rich ore, oxidation may form significant concentrations of partially oxidized sulphur oxyanions, such as:  $S_2O_3^{2-}$ ,  $S_3O_6^{2-}$  and  $S_4O_6^{2-}$ , in addition to sulphate. These partially oxidized sulphur oxyanions are known as thiosalts.

Oxidation of thiosalts to sulphate produces acidity (Reaction 7.1) that may decrease the pH.



Oxidation of thiosalts can be slow and occurs mostly in downstream environments upon discharge, having a negative effect on fish and other aquatic organisms in rivers and lakes. Thus, thiosalts in milling effluent should be oxidized to sulphate and the resulting acidity neutralized before the effluent is discharged to the environment. Thiosalts in effluent ponds will be oxidized chemically and/or biologically, but the rates decrease precipitously with decreasing temperature and may be insufficient in fall, winter and spring in Canada.

### 7.6.3 Deposition and Reprocessing of Tailings

Tailings usually leave the mill as a slurry with the process water and are transported to the

*Alternatives to slurry disposal include partial dewatering in a thickener to produce thickened tailings and filtering to produce drier, easier to handle tailings.*

disposal site in a pipeline. Alternatives to slurry disposal include: (1) partial dewatering in a thickener to produce thickened tailings, which have a higher density and solids content; and (2) filtering to produce drier, easier to handle

tailings. Thickened tailings like a tailings slurry are transported to the disposal site by pipeline. Filtered tailings can be moved by truck and dry stacked.

Tailings slurries are commonly deposited in surface impoundments to prevent the release of tailings into the environment. Impoundments can be created by topographical features and/or dams constructed of sand sized tailings, waste rock or natural surficial materials. Other disposal options include possible deposition in natural water bodies and exhausted open pits or use as backfill in underground workings. Historical tailings management was much poorer than present standards and there may be areas of spilled tailings at older mine sites. The Faro mine in the Yukon spilled 12,300 m<sup>3</sup> of tailings solid and a much larger quantity of slurry into Rose Creek in 1975 due to a breach in the Original Dam (Gartner Lee, 2002).

The deposition of tailings into an impoundment usually occurs onto the tailings beach along the perimeter. The disposal location may be periodically or occasionally moved to avoid too much tailings building up in any one location. Direct discharge of tailings into ponded areas in the center or far edge of the impoundment may occur where there is a need to immediately submerge a portion of the tailings or maximize the use of the existing storage space.

Tailings discharged as slurries onto beaches along the perimeter of an impoundment settle out in thin layers as the slurry flows across the shallow alluvial fans created around the deposition point(s). Differential settling as the tailings solids move downstream from the discharge point results in sand sized, heavier particles preferentially settling adjacent to the disposal location and

*Differential settling as the tailings solids move downstream from the discharge point results in sand sized, heavier particles preferentially settling adjacent to the disposal location and the silt sized, lighter particles settling downstream.*

the silt sized, lighter particles settling downstream. The silt sized particles are often called the tailings slimes and settle in ponded areas. In the sandier tailings beaches close to the deposition point(s), higher concentrations of the heavier

sulphides minerals and lower concentrations of lighter carbonates minerals may result in a higher potential for acidic drainage and elevated metal concentrations. Conversely, lower concentrations of sulphides and higher concentrations of carbonates may result in a lower potential for acidic drainage and elevated metal leaching from the tailings slimes.

The buildup of tailings along a flow path and changes in the spigot location will change the flow path and therefore the location of tailings deposition and the deposition of different sized particles. Consequently, in any one location, there are often overlapping layers with different physical and geochemical compositions and significant lateral and horizontal variations in particle size and mineralogy.

The relatively low water content of thickened tailings results in:

- greater viscosity;
- faster settling;
- a more controlled placement; and
- little or no hydraulic sorting or segregation of different particle sizes so long as they are not discharged into a flooded impoundment.

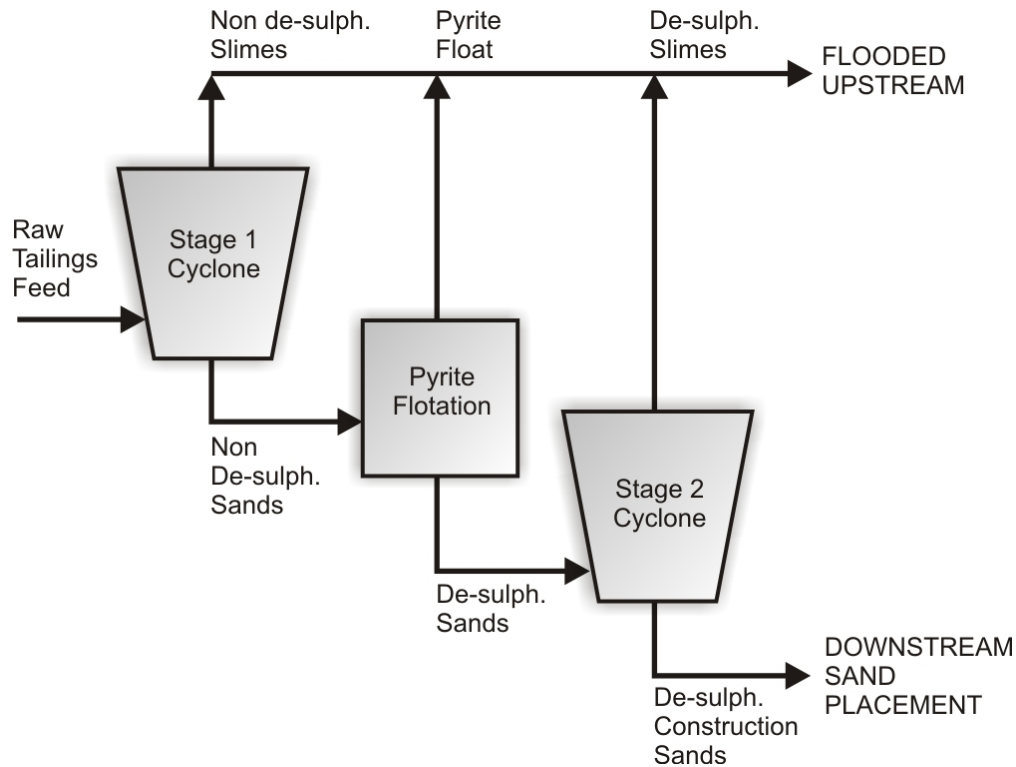
The lack of hydraulic sorting of thickened tailings results in a more uniform particle size distribution and no separate tailings sands and slimes. Thickened tailings are more stable and require perimeter berms rather than dams to contain the solids. Thickened tailings may be used to create paste tailings for backfill.

Additional processing to enable use as backfill or for construction (e.g. Figure 7.2) includes:

- dewatering;
- cycloning;
- desulphurization; and
- effluent treatment.

Where there are concerns regarding the drainage chemistry from even short term exposure to aerobic weathering, tailings may be placed immediately underwater. Immediate underwater disposal is often used for sulphide-rich tailings, the sulphide-rich cleaner tailings fraction and the sulphide byproduct of tailings desulphurization.

Where the volume of suitable mill tailings is insufficient to meet construction or backfill requirements, additional pseudo-tailings may be created by crushing and grinding waste rock or borrow materials (Price, 2005).



**Figure 7.2** The processes to produce cycloned, desulphurized tailings sand that is used to buttress the downstream shell of the Kemess tailings dam in British Columbia.

#### 7.6.4 Drainage and Atmospheric Properties and Processes

Drainage and atmospheric properties and conditions, such as the entry of water and air into tailings, depend on the particle size, method of deposition, depositional history and disposal site. The typically finer particle size of tailings compared to waste rock results in:

- smaller pore size;
- lower permeability for air and water;
- slower vertical water migration; and
- predominantly diffusive rather than convective air movement.

The lower air permeability, greater saturation and lower hydraulic conductivity will reduce the rate

*The lower air permeability, greater saturation and lower hydraulic conductivity will reduce the rate of oxygen supply and pore water migration in tailings compared to waste rock and in tailings slimes compared to tailings sand.*

of oxygen supply and pore water migration in tailings compared to waste rock and in tailings slimes compared to tailings sand. The rate of water movement through tailings can be estimated using groundwater flow modeling software and point measurements of the hydraulic head and hydraulic conductivity. Measurements made in several impoundments (Blowes et al., 2003) indicate that the hydraulic conductivity ranges between  $1 \times 10^{-4}$  and  $1 \times 10^{-8}$  m/s and the vertical hydraulic conductivity is approximately one order of magnitude lower than the horizontal hydraulic conductivity. Average and maximum estimated seepage rates for

vertically infiltrating precipitation at the Faro Mine in the Yukon were 16 and 26 mm/year through the fine tailings and 34 and 75 mm/year through the coarse textured tailings.

Due to the relatively low hydraulic conductivity, process water will saturate the tailings and impede air entry during active deposition. The height of the water table after mining will depend on the:

- permeability of the tailings;
- permeability of the dams and surrounding landforms; and
- drainage inputs from incident precipitation, groundwater and diffuse and discrete surface drainages sources.

Tailings impoundments often have low permeability dams or inner slopes that keep most of the tailings saturated. Even where the perimeters are permeable, tailings impoundments may be located in natural depressions that, in addition to minimizing the cost of building dams, have high off-site drainage inputs and are naturally flooded, resulting in an elevated water table within the tailings. Consolidation over time lowers the tailings surface resulting in a deeper water cover over flooded tailings and a greater degree of flooding in partially flooded tailings.

After deposition ceases at closure, if the dams and confining landforms are permeable and there

*After deposition ceases at closure, if the dams and confining landforms are permeable and there is a negative water balance, the height of the water table will decrease, allowing air entry.*

is a negative water balance, the height of the water table will decrease, allowing air entry. Also, the higher hydraulic conductivity will result in a lower water table in the more permeable tailings sands compared to the more poorly drained tailings slime fraction. In wetter climates, saturated conditions are quite likely in tailings slimes due to their low

hydraulic conductivity. The fine texture of tailings may result in the upward movement of pore water due to capillary forces, raising the height of saturated conditions.

Unlike waste rock, lateral surface runoff and near surface seepage are often large parts of the contaminant load from tailings. A significant portion of surface drainage inputs, especially during large precipitation and snow melt events will exceed the infiltration rate of the tailings surface and will flow as runoff offsite or to topographic lows within the impoundment. Lateral runoff will be increased by low permeability horizontal layers formed during deposition or later weathering. The formation of low permeability cemented layers, known as hardpans, results from the immediate precipitation of oxidation products, like iron oxyhydroxides or gypsum, at a depth where there are changes in drainage chemistry that affect their solubility.

The principal mechanism of air movement in tailings is diffusion in response to concentration gradients. However, gaseous diffusion will decrease with increasing moisture content and saturation. Air movement may also occur due to advection in response to pressure gradients resulting from changes in atmospheric pressure, the consumption of oxygen or changes in temperature resulting from the exothermic oxidation of sulphide minerals. Advective air movement is unlikely to be significant at depth in tailings due to the fine grain size and low permeability of most tailings (Blowes et al., 2003).

### 7.6.5 Weathering and Contaminant Migration

Properties and processes of weathering and contaminant migration, such as the type, location and rate of weathering, erosion and contaminant migration, will depend on the:

- physical and geochemical composition of the tailings;
- chemistry, location and rate of drainage inputs;
- atmospheric and drainage conditions of the disposal site;
- height of the water table and capillary rise;
- rate of oxygen supply at different depths;
- the paths of contaminant migration; and
- geochemical composition of materials and attenuating reactions further down the flow path.

Due to the fine texture of many tailings:

- a portion of most mineral grains in tailings will be exposed to the pore weathering conditions;
- tailings can have a much higher surface area per unit mass than waste rock;
- the rate of oxygen supply and therefore oxidation will be reduced at depth; and
- there may be significant lateral surface runoff and near surface seepage.

During active deposition, saturation by process water will limit oxidation in many tailings. Alkalinity in process water will neutralize any acidity produced by sulphide oxidation and thus the drainage chemistry will likely be similar to that of the process water.

With the cessation of tailings disposal, the only drainage inputs will be incident precipitation and any off-site drainage inputs. One method for measuring the rate of water migration through the tailings is to track the rate of depletion of unique components of the process water.

*With the cessation of tailings disposal, the only drainage inputs will be incident precipitation and any off-site drainage inputs.*

Drying of the tailings following mine closure or during prolonged periods with no tailings deposition during active mining will result in aeration and the initiation of aerated weathering processes, such as sulphide oxidation. Products from aerated weathering will be physically encapsulated and chemically modified by fresh tailings if there is subsequent tailings disposal.

The change in drainage inputs and the initiation of aerated weathering processes will change the pore water chemistry, potentially resulting in the precipitation and dissolution of different secondary minerals. The rate of the oxidation will depend on the rate of oxygen inputs and consumption and if the pH is low enough, the concentration of ferric iron. Measurements made at several tailings impoundments indicate that the concentration of oxygen gas within pores decreases with increasing depth (Blowes et al., 2003). Due to the low air permeability and oxygen consumption by sulphide oxidation, even in well drained tailings, the gas phase may be depleted of oxygen and sulphide oxidation may be minimal at depth (Section 7.6.4) even in sandy, well drained tailings.

Contaminant migration will result from:

- lateral surface runoff and near surface seepage;
- vertical and lateral seepage through the tailings; and
- wind erosion.

Due to a lower vertical hydraulic conductivity and limited air movement into many tailings, the

*The highest contaminant loading from tailings may be in surface and near surface runoff moving laterally off-site during snowmelt and large rainfall events.*

highest contaminant loading may be in surface and near-surface runoff moving laterally off-site during snowmelt and large rainfall events. The chemistry of surface runoff will depend on the weathering conditions and solute concentrations

in the near surface tailings and the interaction between the tailings and the runoff. The formation of surface and near surface crusts, such as hardpans, may reduce infiltration and increase the proportion of runoff. Hardpan will take time to form and may migrate deeper within the tailings due to dissolution and reprecipitation as weathering progresses. Perched water tables formed on subsurface cemented layers may arrest sulphide oxidation.

The rate of contaminant migration vertically and laterally through the tailings will depend on the hydraulic conductivity, rates of weathering, contaminant dissolution and secondary mineral precipitation and dissolution. Mineral depletion and secondary mineral precipitation and dissolution due to weathering may result in progressive changes in pore water pH in tailings over time, starting at the surface and moving downward. Changes in pore water pH may dissolve secondary minerals formed under previous weathering and pore water chemistry.

As weathering continues, changing geochemical conditions may result in the propagation of

*As weathering continues, changing geochemical conditions may result in the propagation of contaminant fronts with different drainage chemistries through the tailings.*

contaminant fronts with different drainage chemistries through the tailings. There are three different contaminant fronts in the pore water moving downward through

the massive sulphide tailings at the Faro Mine in the Yukon (Gartner Lee, 2002). The first and now deepest front produced by the initial sulphide oxidation and carbonate mineral dissolution has a near-neutral pH but elevated total dissolved solids (TDS), principally due to the sulphate concentration. The second contaminant front produced by the oxidation of sphalerite (ZnS) and the depletion of carbonate minerals has a slightly acidic pH and elevated zinc. The upper contaminant front produced by the depletion of sphalerite (ZnS) and the oxidation of pyrite (FeS<sub>2</sub>) is characterized by an extremely low pH and elevated iron concentration. Complicating this geochemistry in some locations is the inundation of contaminant fronts that developed during periods of temporary mine closure.

The migration of the sulphide oxidation and other weathering fronts deeper into the tailings may be arrested by a lack of oxygen due to low air permeability or an elevated water table. Changing redox conditions may alter the solubility of dissolved chemical species and secondary minerals, changing the chemistry of contaminant fronts and the rate of contaminant migration. Seasonal, annual or progressive fluctuations in air entry and flooding due to fluctuations in the height of water table or the formation of cemented layers may dissolve previous oxidation products.



Some contaminant fronts may eventually reach the base of the tailings and enter the underlying strata. The physical and chemistry properties of the underlying strata may change the solubility of dissolved chemical species and secondary minerals, changing the chemistry of those contaminant fronts and their rates of contaminant migration. For tailings impoundments built on top of organic rich soils or wetlands, contaminants discharged from the tailings are at least temporarily attenuated by natural organics and clay minerals. The fate of precipitated contaminants will depend on the composition of the attenuating materials and the geochemistry of future contaminant fronts.

The particle size and rapid drying make fine tailing sand highly susceptible to wind erosion. Drying out of the surface of exposed tailings beaches during temporary or permanent closure may result in wind blown tailings contaminating surrounding land and water courses with trace metals. The amount of wind erosion depends on the moisture content, particle size, surface roughness, surface cover and wind velocity.

### 7.7 Stockpiles of Ore and Low Grade Ore

Ore is material that contains economically recoverable levels of coal, metals or minerals under

*Low grade ore is relatively deficient in the target metals/minerals, but could be ore under potential, given slightly more favourable, commodity prices and mining and milling costs. Low grade ore is segregated to permit milling at some later date if economic conditions become more favourable.*

existing commodity prices and mining and milling costs. Low grade ore is material that, compared to ore is relatively deficient in the target metals/minerals, but could be ore under potential, given slightly more favourable, commodity prices and

mining and milling costs. Low grade ore is segregated to permit milling at some later date if economic conditions become more favourable. The cut-off grade and composition of the ore and low grade ore will depend on commodity prices, mining and milling costs, regulatory requirements and the geology of the deposit. Since the distinction between the ore, low grade ore and waste rock is determined by transitory economic factors, their future geochemical composition may vary, and the fate of ore and low grade ore stockpiles are somewhat uncertain.

Ore and crushed ore are stockpiled so there is always sufficient feed for the mill. The length of time ore spends in stockpiles will depend on many different factors. Factors that may increase the period of time spent in stockpiles include temporary or permanent shutdowns, modifications to the mill, and the campaigning of different types of ore, such as oxidized and unoxidized ore, through the mill. Typically, the time ore spends in stockpiles is minimized to prevent changes that reduce the recovery of economic commodities. Ore stockpiles are usually milled prior to mine closure. Even if ore is changed into wastes by declining commodity prices, milling and disposal of tailings is usually the most cost-effective method for removing the stockpiled material to the waste disposal facilities.

Although ore is often only stockpiled for relatively short periods of time, it can release drainage with unacceptable chemistry if it contains leachable, soluble constituents or if sulphides are highly reactive. In many cases, the wetting of the ore needed for weathering and leaching is prevented by:

- a cover;
- continual addition of fresh ore; or
- limiting the time of exposure.

Where dry ore, especially crushed ore is exposed to the wind, the greatest environmental concern may be the potential for wind blown dust to contaminate downwind land and water. An indirect environmental concern with ore stockpiles is the fate and potential drainage chemistry of any underlying material contaminated by ore and low grade ore stockpiles.

Prediction of drainage chemistry from low grade ore placed in stockpiles is needed because:

- the time of exposure is often longer than that for the high grade ore; and
- poorer than expected economic conditions causing mine closure often make the milling of low grade ore uneconomic and the low grade ore stockpiles become long term waste rock dumps.

Low grade ore and uncrushed ore typically are produced by the same mining methods and therefore are likely to have a similar particle size to waste rock.

## 7.8 Wastes and Sediment from Drainage Collection and Treatment

Collection and treatment of drainage is the primary means of environmental protection at many major historic and older mine sites. For new mines, collection and treatment is often the only feasible mitigation strategy for open pits and underground mines producing poor drainage chemistry and the primary contingency measure where there is significant uncertainty regarding future drainage chemistry.

Drainage collection and treatment produce two categories of waste:

- wastes produced by drainage treatment; and
- sediment that accumulates in the drainage collection system.

Prediction of the potential drainage chemistry from the waste and sediments will be required to create disposal plans that provide physical containment and dischargeable drainage or mitigation plans for any poor drainage chemistry. For example, operators of biological treatment systems need to predict the composition and future drainage chemistry from the “treatment matrices” that no longer have sufficient reactivity or hydraulic conductivity and need to be removed or replaced.

The wide variety of drainage collection and treatment systems produces a wide variety of

*The wide variety of drainage collection and treatment systems produces a wide variety of different sediments and treatment wastes.*

different sediments and treatment wastes. Treatment wastes from active chemical treatment may be produced daily while substrates from a treatment wetland may become waste products only after years or decades. Treatment wastes may be

produced once, such as in the one time treatment of process water after the mine closure, or seemingly in perpetuity, where there is long term treatment of ARD or neutral pH drainage.

Sediment in the drainage collection system will consist of:

- precipitates produced by evaporation and changes in solubility limits;
- particles eroded along the drainage pathways; and
- debris such as plant material.

Sediment will accumulate in areas with low flow or where the mixing of different drainage sources causes previously soluble species to precipitate.

The drainage chemistry from the waste and sediment from drainage collection and treatment will depend on:

- their physical form and chemical composition; and
- geochemical, atmospheric and drainage conditions of the disposal environment (Figures 7.3 and 7.4).

The physical and chemical properties of the waste and sediment from drainage collection and treatment, such as chemical phases and speciation, will depend on the:

- chemistry and sequence of mixing of different drainages;
- composition of eroded and excavated surficial materials; and
- materials, methods and geochemistry of the treatment system.

For example, all of the treatment parameters such as agitation rates, sludge recycling, flocculants type and dose and the iron content of the drainage may impact the geochemical stability of lime treatment sludge.



**Figure 7.3** Low density lime treatment sludge stored in an aerated pit lake.



**Figure 7.4** High density lime treatment sludge stored on a gravel pad to maintain aerated conditions.

## 7.9 Other Sulphidic Materials

Other possible sulphidic materials for which prediction of the drainage chemistry may be required include:

- non-lithified overburden stripped to access mine workings and create stable foundations for dams, buildings and other mine components;
- bedrock and non-lithified overburden obtained from borrow pits for use in construction;
- waste rock and borrow materials used directly or crushed for use in surfacing roads and airstrips;
- rock cuts created during the construction of roads or foundations;
- sulphidic materials, such as tailings, ore or concentrate, spilled along load-out, transportation routes or processing facilities; and
- secondary minerals and amorphous materials along drainage paths or water courses that have been precipitated or adsorbed from sulphidic drainage discharged into the environment.

Finding construction materials whose future drainage chemistry is acceptable can be a major challenge at sites where almost all geologic materials contain elevated concentrations of sulphide minerals or their oxidation products.

*Finding construction materials whose future drainage chemistry is acceptable can be a major challenge.*

Secondary minerals and amorphous materials that have precipitated or been adsorbed along drainage paths or water courses from previous sulphidic drainage may continue to be a cause of adverse drainage chemistry long after the discharge has stopped (Figure 7.5).

## 7.10 Co-Disposal of Different Waste Materials and Drainages

Many mine components often contain several different waste materials and drainages from different sources. Different wastes and waters may be co-disposed to take advantage of existing disposal facilities, similar disposal requirements and reduced costs. For example, waste rock that needs to be flooded can be placed in a flooded

tailings impoundment. Both tailings and waste rock may be used as backfill for structural support in an underground mine.

A complete inventory is required of the physical properties, drainage properties and geochemical composition, including the relative location and potential interaction of different materials, no matter how small. Often, the problematic drainage chemistry from co-disposed material comes from a relatively small portion of the mass that is far more reactive, under existing or new geochemical conditions.

Wastes are co-disposed, either by mixing them prior to disposal or by placing them in the same disposal location. Domestic sewage and residues from drainage treatment can be mixed with tailings prior to disposal during active mining, but must be disposed of on the surface after the milling stops.





**Figure 7.5** Materials that have precipitated along water courses may continue to affect their drainage chemistry long after the discharge has stopped.

Tailings impoundments and pit lakes are often a convenient short term solution to the problem of where to dispose of problematic materials such as weathered exploration wastes, material cleaned out of settling or collection ponds, treatment waste products or off-spec site drainages. Table 7.3 lists the large number of different materials placed in one particular tailings impoundment.

**Table 7.3** An example of the different materials placed in a tailings impoundment.

Tailings	33.7 Mt
Treatment Sludge (95% moisture)	974,385 m <sup>3</sup>
Bulk Sulphide	30,000 t
Products from a Short Term Arsenic Leach Plant	Unknown
Weakly Acidic Drainage during Mining	4.6 Mt
Sodium Sulphate Landfill	2,500 t

The contribution of co-disposed materials to the resulting drainage chemistry will depend on their:

- physical and chemical composition;
- disposal location; and
- subsequent weathering and hydrogeologic conditions.

During active mining, materials co-disposed in a tailings impoundment may be buried by the tailings and their drainage chemistry masked by that of the process water. After mining, the overlying tailings may reduce air entry into, and contaminant migration from, buried wastes.

An important consideration in the co-disposal of wastes is that changing geochemical conditions may affect the co-disposed wastes differently. For example, a reduction in the redox potential of fresh, unoxidized tailings and waste rock in a flooded impoundment will minimize future oxidation. However, it may also result in the reductive dissolution of ferric iron contained in the co-disposed oxidized wastes such as lime treatment sludge or roaster wastes, releasing the co-precipitated trace elements, such as arsenic and zinc, to the water in the impoundment.

Secondary minerals and amorphous materials that precipitate when different drainage chemistries are mixed can remain problematic constituents. For example, precipitated metals from neutralized acidic drainage may be insoluble while the pH remains alkaline due to the addition of process water. When the mine closes and process water is no longer added, chemical reactions, such as the oxidation of ammonium and thiosalts and the replacement of process water by incident precipitation may lower the pH to near neutral or slightly acidic. The solubility of the precipitated metals may be greatly increased under these new pH conditions, potentially resulting in elevated metal concentrations in seepage or an overlying water cover.

*Secondary minerals and amorphous materials that precipitate when different drainage chemistries are mixed can remain problematic constituents.*

### 7.11 Prediction Guidelines for Project Components

A comprehensive review of the properties and processes of the excavations and waste materials created by the project, and the resulting project components and the project as whole, is needed to ensure a good prediction program. Such a program could:

*A comprehensive review of the properties and processes of the excavations and waste materials created by the project and the resulting project components and the project as whole, is needed to ensure a good prediction program.*

- predict the drainage chemistry of all the geologic materials, waste materials, project components and drainages, including materials produced by segregation, mass wasting, erosion and weathering (Section 3.2 and Chapter 6);
- predict the drainage chemistry throughout the life of a project and after closure (Chapters 3 and 4);
- consider the range, variability and temporal changes of all potentially influential weathering properties and processes (Chapter 6) in the selection of analyses and tests and the interpretation of results (the following chapters);
- compare the actual drainage chemistry with the predicted performance; and

- identify previous actions or future developments that alter previous predictions of the geochemical composition, weathering conditions and the resulting drainage chemistry or the materials and methods needed to predict the drainage chemistry.

Project plans and properties and processes are always in flux (Section 3.8 and this chapter). A comprehensive review of the status, properties and processes of the project could occur at regular intervals and whenever there are major changes to present, proposed or predicted project, site or weathering conditions. These are discussed in the following subsections.

### 7.11.1 General Properties and Processes of a Project

General properties and processes of a project that would be useful to measure, track and record in a project inventory are the following:

- project history, present stage, future developments and changes to plans that were the basis of previous drainage chemistry predictions;
- excavation methods, resulting excavations (e.g. open pits, underground workings and quarries) and material excavated (e.g. ore, waste rock and non-lithified overburden);
- processing methods (e.g. concentrator, roaster, cycloning and desulphurization), facilities and material produced;
- waste materials (e.g. waste rock, tailings, products of effluent treatment, soil and other forms of non-lithified overburden, sediment removed from drainage collection structures and mixtures or modifications of the previous materials such as desulphurized or cemented tailings);
- other materials such as galvanized steel or residual blasted rock;
- project components (e.g. waste rock dumps, tailings impoundments, excavations, foundations, roads, dams and other infrastructure) and their construction methods and materials;
- materials produced during and after excavation, processing and deposition by segregation, mass wasting, erosion and weathering;
- drainage inputs, drainage conditions, flow paths, mixing of different drainage chemistries, levels and fluctuations in flooding, drainage discharges and water management features;
- atmospheric conditions – air quality, oxygen supply and temperature; and
- any mitigation methods.

Information on the following could be collected for each geologic unit and proposed or existing excavation, waste product, project component and material created by segregation, mass wasting, erosion and weathering:

- date of excavation, production and exposure to weathering, leaching and other forms of disturbance, marking the start of weathering and oxidation;
- location and site conditions; and
- rate of production, volume, tonnage, dimensions and any amendments added to each project component.

It would also be useful if the information provided on the general properties of the project would include plans and maps showing the site and project components (Chapter 6). Site plans should show the pre- and post project topography and the location of project components, natural



drainage features and water management features (Figure 6.2). Plans for individual project components could show the location of the different geologic units, waste products, mitigation measures and drainage features.

### 7.11.2 Physical Properties and Processes

Physical properties of each proposed or existing excavation, waste product and project component that can be measured, tracked and recorded in a project inventory include the following:

- particle size distribution;
- particle surface area;
- structure; and
- particle strength.

The particle surface area of large coarse fragments is logistically very difficult to measure. This coarser portion, which can be most of the mass of waste rock (Section 7.4.2), is often omitted in most measurements of the particle size distribution of waste rock.

Because of their impact on weathering conditions and leaching, the particle size, strength, structure and surface area must be considered in the selection and design of tests and the interpretation of results. This is highlighted in the following chapters.

Through time, changes may occur in physical properties due to processes such as particle fracturing, breaking, compaction, migration and precipitation. Because these processes may impact drainage chemistry, it is important that they be considered in the prediction of drainage chemistry.

### 7.11.3 Hydraulic Properties and Drainage Conditions

Hydraulic properties and drainage conditions that could be measured, tracked and recorded in a project inventory in order to develop an understanding of the weathering conditions and rate of leaching for each proposed or existing waste product and project component and for the project as a whole are:

- climate, topography, hydrology and hydrogeology of the site (Chapter 6);
- hydraulic properties of each geologic unit or waste product combination in each project component;
- mining activities, such as water use, flow, pumping and the volume of water added with tailings;
- rates and locations of other drainage sources and drainage losses and the resulting leaching, flow paths, water balance, rate of flooding and the height and fluctuations in the height of the water table of each project component; and
- site water management, mitigation measures and other activities or events that may impact the above.

The source, rate, location and chemistry of drainage inputs, losses, discharges, leaching, flow paths and flooding are needed to predict the:

- water balance;
- rate of flooding;
- fluctuations in height of the water table;
- discharge location(s);
- solubility; and
- loadings.

Hydraulic properties and drainage conditions of project components that may significantly affect weathering conditions, rates of leaching, drainage chemistry and loading and that should be considered in the selection of prediction analyses and tests and the interpretation of results include the:

- chemistry of drainage inputs;
- cemented or compacted layers with a relatively low hydraulic conductivity;
- relative rates of sulphide oxidation and leaching; and
- occurrence of permanent or periodic saturation or flooding.

The formation of cemented or compacted layers with a relatively low hydraulic conductivity may reduce the infiltration of incident precipitation and increase lateral surface or near-surface seepage and leaching of the underlying strata.

Relatively high rates of sulphide oxidation compared to leaching may result from sulphidic geologic materials with large particle surface areas, high sulphide mineral concentrations, or low drainage inputs. Relatively high rates of sulphide oxidation compared to leaching result in the following occurrences.

- Concentrations of contaminants of concern in the discharge are a function of the solubility of secondary minerals rather than the rate of sulphide oxidation.
- Weathering products progressively accumulate in the project components.
- Contaminant loadings will increase if drainage inputs increase or changes in drainage chemistry increase mineral solubility.

Saturation or flooding will decrease the oxygen supply and the rate of sulphide oxidation, but

*Saturation or flooding will decrease the oxygen supply and the rate of sulphide oxidation, but may increase the rates of leaching.*

may increase the rates of leaching. The degree to which this may happen will depend on the residual oxygen concentration, the rate of flow of the drainage and the duration of aerobic

weathering conditions prior to flooding. Periodic saturation or flooding may increase the rate of leaching and contaminant discharge.

The monitoring of drainage conditions on or around project components can include the following.

- Climate stations and snow courses, which monitor incident precipitation, snow depth and water content, infiltration, evaporation and transpiration, can be used to estimate drainage inputs from incident precipitation.
- Piezometers, which monitor the height of the water table, can be used to estimate the levels of seasonal leaching and permanent saturation.
- Weirs, which monitor surface water flow, can be used to estimate discrete drainage inputs and outputs.
- Automatic samplers and standpipes can be used to collect samples of discrete drainage inputs and outputs and drainage beneath project components.

Site monitoring of climate and flows of surface waters and groundwaters is required to estimate drainage inputs and losses. Where possible, inputs and outputs and a water balance should be derived for individual project components and sub-watersheds for the range of operating, closure and climatic conditions.

The sub-surface components of water inputs or discharge may be difficult to measure and are thus sometimes estimated by subtracting other components from the total inputs or discharge. Such mass balance calculations of sub-surface drainage are not reliable where there are both sub-surface inputs and discharges or the magnitude of other components of water inputs or discharge, such as infiltration through a cover, are uncertain.

When predicting future drainage chemistry, it is important to consider the temporal changes in

*When predicting future drainage chemistry, it is important to consider the temporal changes in drainage properties and processes due to individual climate events, seasonal and annual climate differences and longer term climate changes.*

drainage properties and processes due to individual climate events, seasonal and annual climate differences and longer term climate changes. Seasonal differences in drainage may have a large impact on water inputs, and should be considered when estimating the rates and locations of flooding, leaching and drainage discharge (Price, 2005). In addition

to precipitation, other climate influences on recharge result from properties and processes such as temperature and wind that affect the rates of transpiration and infiltration and the movement and water content of snow. For example, whether the ground is wet prior to freezing will greatly impact the rate of infiltration when the snow pack melts in the spring.

Sensitivity analysis of the impact of flooding and other major discharge events on drainage chemistry and loadings may warrant detailed projections of the impact of extreme short and long term climatic events on portions or all of the site's water balance. The input data and resulting site water balances should be periodically updated and checked against pre-project estimates.

#### **7.11.4 Atmospheric Properties and Processes**

Information on the following properties and processes can be measured, tracked and recorded in order to develop an understanding of how atmospheric conditions may affect the weathering conditions for each proposed or existing excavation, waste product and project component:

- climate of the site (Chapter 6);
- weathering reactions and composition of the pore gas;
- temperature;
- particle size and structure;
- drainage conditions; and
- site management, mitigation measures, climate change and off-site activities or events that may impact the above.

Atmospheric properties and conditions such as temperature, a lack of oxygen supply and wind erosion may play a major role in determining the weathering conditions and the resulting drainage chemistry. Therefore, they must be considered in the selection and design of tests and the interpretation of results.

The monitoring of atmospheric conditions in or around project components can include climate stations which monitor temperature, wind speed and direction and atmospheric pressure. Sediment traps can be used to measure wind erosion. This apparatus can be used to measure the surface oxygen flux.

Monitoring wells with ports providing access to the oxygen concentration and temperature of the pore gas at different depths in the project component can be used to identify areas where:

- low air permeability greatly reduces the oxygen supply, minimizes the rate of sulphide oxidation and limits the supply of weathering products;
- permafrost may minimize the rate of sulphide oxidation and limit the supply of weathering products; or
- high temperatures may greatly increase the rate of sulphide oxidation.

The rate of sulphide oxidation may depend on the rate of oxygen supply rather than the oxygen concentration at any one time and therefore monitoring of the oxygen concentration should be done over a period of time. In other words, depletion of oxygen may be primarily due to oxygen consumption by rapid sulphide oxidation rather than a lack of oxygen supply.

Temperatures can be used to:

- scale-up reaction rates from laboratory studies;
- locate zones with high rates of sulphide oxidation; and
- track changes in the rate of sulphide oxidation.

Heat produced by sulphide oxidation may result in temperatures within project components exceeding ambient air temperatures. Heat and high solute concentrations produced by sulphide oxidation may prevent permafrost from forming in waste rock, despite the fact that it may occur in the surrounding ground. Surface evidence of high temperatures within a project component includes surface venting of hot air, snow melt and dead vegetation. Climate change may further increase temperatures and reduce the extent of freezing.

Modeling may be used to estimate rates and locations of atmospheric inputs, losses, flow paths and discharges. Modeling requires a good understanding of the physical and drainage properties of the project component and thus is not a substitute for site specific information (Chapter 6). Due to the limitations in measuring or predicting physical and drainage properties, detailed monitoring of properties such as concentration of oxygen, temperature and surface oxygen flux is needed to develop a model and verify the results.

*Modeling requires a good understanding of the physical and drainage properties of the project component and thus is not a substitute for site specific information.*

### 7.11.5 Geochemical Properties and Processes

Information on the following geochemical properties and processes would be useful to measure, track and record for each geologic unit (Chapter 6), proposed or existing waste product and project component (preceding sections of Chapter 7), and for the project as a whole:

- geology;
- initial geochemical composition;
- weathering properties and processes, the resulting changes in geochemical composition and contaminant migration;
- chemistry and loadings of drainage inputs, internal drainage and drainage discharge; and
- site management, mitigation measures and off-site activities or events that may impact the above.

Information on these properties and processes can be derived from:

- analyses of different aspects of the geochemical composition of geologic units, waste products and project components;
- kinetic tests and monitoring of the resulting weathering of geologic units, waste products and project components;
- monitoring of the chemistry, suspended sediment concentrations and flow of drainage inputs, internal drainage and drainage discharge;
- monitoring of physical, drainage, atmospheric and weathering conditions; and
- plans and records of mining activities.

The types of information and the level of detail required for each geologic unit, waste product and project component will depend on the potential variability of the drainage chemistry and environmental impacts, mitigation measures and depositional environment.

Of great importance for sulphidic geologic materials is the relative rate of exposure through time of acid generating versus acid neutralizing minerals and the cumulative exposure of reactive minerals that contain elements of environmental concern. The geochemical properties of each geologic unit and waste product in each project component is important

*Of great importance for sulphidic geologic materials is the relative rate of exposure through time of acid generating versus acid neutralizing minerals and the cumulative exposure of reactive minerals that contain elements of environmental concern.*

because only a small proportion of the mass may be responsible for the majority of the deleterious drainage.

Although the primary focus is often on the geochemistry, other factors such as physical, drainage and atmospheric properties and processes, such as particle size, hydraulic conductivity, air entry and temperature may also play an important role in determining weathering conditions and the resulting drainage chemistry. In addition to the dissolution of weathering products, other potential chemical inputs to drainage chemistry include different types of atmospheric inputs and dissolved and suspended sediment in the drainage.

The prediction program should consider all elements, minerals and drainage pH values as well as consider using measurements of the past and present geochemical composition, weathering properties and processes and resulting drainage chemistry to predict future drainage chemistry. It is important to recognize that many key properties and processes are in flux and their rate, location and chemistry may change with time.

Another important consideration is the need to predict the drainage chemistry of all geologic materials and consider the range and variability of all potentially influential properties and processes. While concentrations of key geochemical parameters, such as the pyrite concentration, might be orders of magnitude lower in geologic materials outside the main area of mineralization, these lower concentrations coupled with other site specific properties and processes, such as elevated trace element concentrations and a sensitive receiving environment, might still be capable of producing unacceptable environmental impacts.

#### 7.11.6 Conceptual Models of the Project, Site and Project Components

Conceptual models of the overall project and site are needed to develop an overall picture of:

- the spatial and temporal relationships of different project components;
- the exchange of solids and water among different project components, the rates of exchange and any discharge to the environment;
- the disturbance, exposure, excavation and reworking of geologic units, their distribution among different mine components and where they are deposited; and
- the depositional conditions for each waste type/ exposure type/ geologic unit combination.

A site specific conceptual model is a good method for appreciating and communicating the

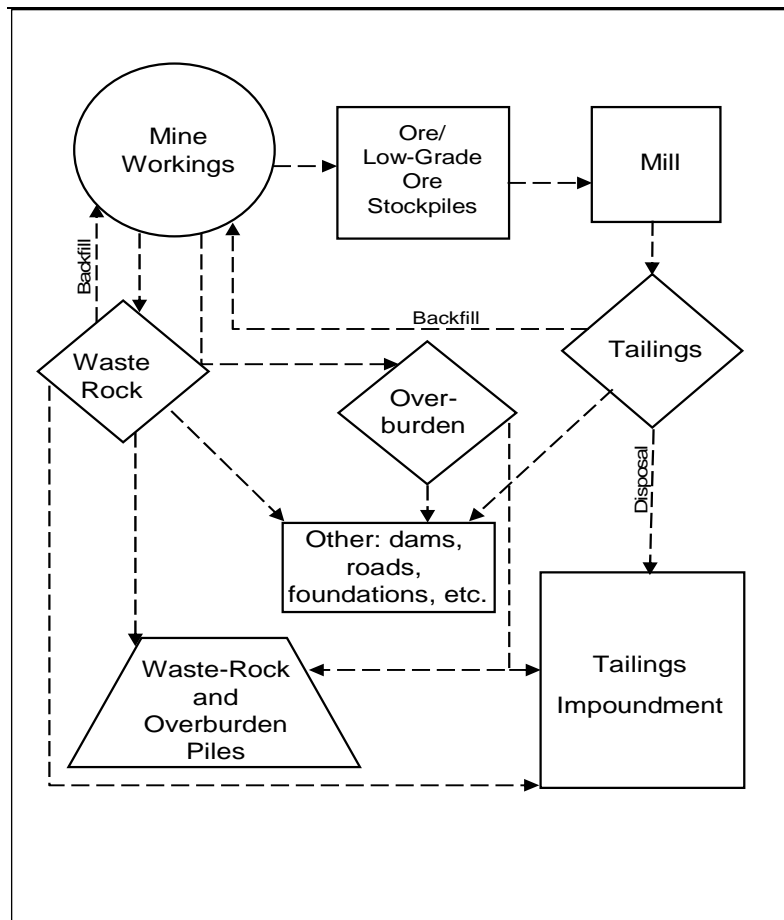
*A site specific conceptual model is a good method for appreciating and communicating the magnitude, spatial layout and interactions between potential sources, pathways and receptors of drainage chemistry.*

magnitude, spatial layout and interactions between potential sources, pathways and receptors of drainage chemistry and ensuring all properties are considered. Conceptual models will help in the assessment of potential concerns, influential properties and processes, and information

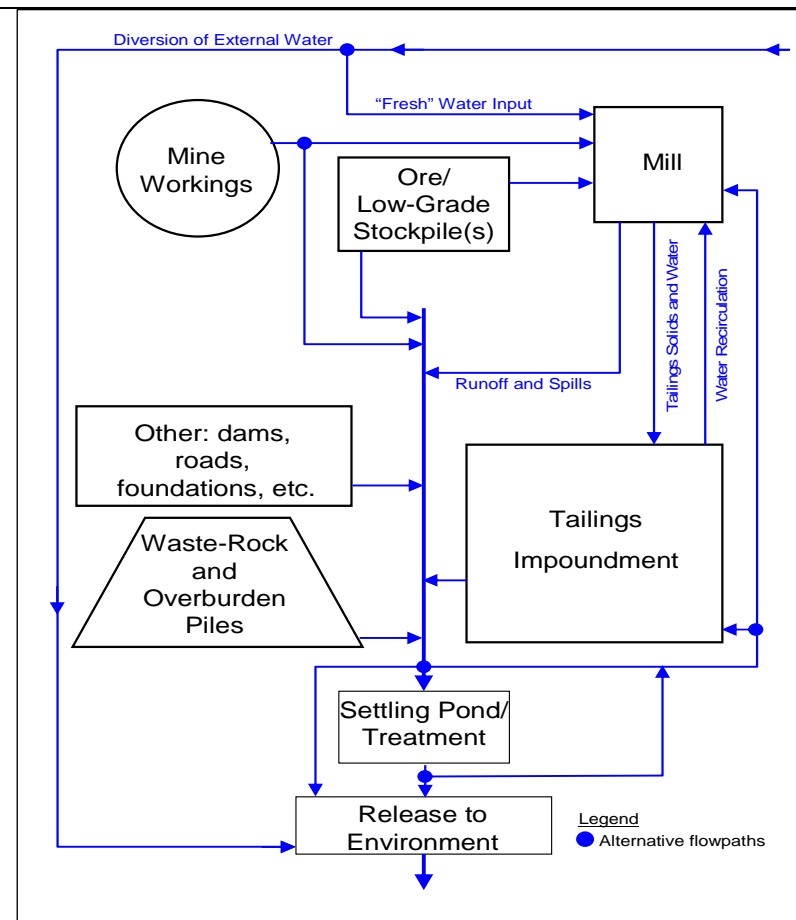
requirements. They will also aid in the interpretation of analysis and monitoring results and help ensure that the program predicts the drainage chemistry of all geologic materials and project components.

The information on the site and project components in conceptual models include: the type of wastes and mine workings and their geologic composition, excavation methods, materials handling, deposition, drainage inputs and outputs, flow paths to the environment and other relevant properties and processes contributing to drainage chemistry and its potential impact. The model should be refined periodically throughout the life of the project and whenever there are major changes to the site or project components.

Different models will likely be required to depict different aspects of the project. Figures 2.1, 3.6, 7.6a and 7.6b are examples of different conceptual models. Figure 7.6a is a conceptual model of the mine workings and waste materials showing the movement of solids between different project components. Figure 7.6b uses a similar conceptual model of the mine workings and waste materials to show discrete drainage sources, pathways and discharges for the different sulphidic site components. Figure 2.1 shows the waste type, management unit and mitigation or disposal strategies for different geologic units. Figure 3.6 is a model of potential loadings from different site components showing their relative impact on the receiving environment if there is no mitigation.



**Figure 7.6a** Conceptual model of the mine workings and waste materials showing the movement of solids between different project components.



**Figure 7.6b** Conceptual model of drainage sources, pathways and discharges.



### 7.11.7 Additional Prediction Guidelines for Excavations

The potential sources of deleterious drainage in excavations that need to be considered in the prediction of drainage chemistry include (Section 7.2):

- mine walls;
- fractures and talus associated or produced from the mine walls;
- backfill;
- residual blasted rock; and
- other materials such as galvanized steel.

When first excavated, mine wall surfaces and fractures and the residual rock particles from the

*When first excavated, mine wall surfaces and fractures and the residual rock particles from the blast will be the largest surface area. Over time, backfill and/or talus produced by wall collapses may become a much larger surface area and the largest source of weathering products in mine workings.*

blast will be the largest surface area. Over time, backfill and/or talus produced by wall collapses may become a much larger surface area and the largest source of weathering products in mine workings. Wall collapses and the particle surface area

of talus will be relatively small if the excavation voids are almost entirely backfilled.

The leaching of weathering products will depend on the rates and locations of water inputs and discharges. Flooding, which is a common occurrence in excavations, has a major impact on weathering conditions and the rate of leaching. The drainage chemistry from areas of flooding and the analyses and test work needed to predict their performance will depend on:

- where flooding will occur;
- materials in the flooded excavation;
- weathering conditions and time of exposure prior to flooding; and
- location, rate and direction of flow and discharge within flooded workings.

Excavation of mine workings will cause both temporary and permanent changes to drainage inputs and discharges. Major water inputs and flow paths should be measured and mapped prior to abandonment of mine workings. Drainage sources that result in relatively rapid leaching in open pits should be at least visible even if they are inaccessible after mine closure. Major inflows and the influence of wall collapse on flow paths and relative leaching rates will be more difficult to monitor in underground mines.

An important part of the prediction for mine workings will be the identification of materials with a high rate of leaching, a sizeable surface area, and a potentially problematic geochemical composition, as well as conditions conducive to their weathering. The importance of these areas has been illustrated at a number of sites by the high rates of contaminant loadings from relatively small masses of high sulphide rock, blasted just prior to mine closure and left in a region of high leaching, instead of being removed.

#### 7.11.7.1 Prediction Prior to Excavation

During project planning, the location of the final mine walls and likely areas of flooding can be estimated from the mine plan and site hydrology and hydrogeology. Information on the geology, mineralogy and geochemistry of the walls can be obtained from analyses and tests conducted on samples from drill core taken from the predicted wall locations. Fracture density, rock strength and rapidly weathering minerals and rock can be used to predict geologic materials that are likely sources of talus and to estimate their geochemistry and mineralogy.

Pre-mine prediction for backfill can follow the procedures for waste rock, tailings products and other backfill sources, with modifications for any differences in materials handling, reprocessing, amendments or segregation as a result of backfilling. Properties and processes of waste rock and tailings backfilled in mine workings that may have an effect include the following:

- low air permeability and hydraulic conductivity may result in low rates of sulphide oxidation and the preferential flow of drainage around rather than through backfilled paste tailings;
- cement may reduce air permeability and hydraulic conductivity, provide extra neutralization potential (NP) and produce an alkaline drainage pH;
- the relatively high solubility of cement may result in its faster depletion compared to other NP sources if cemented backfill is leached or flooded; and
- collapse or mass wasting of backfill will increase the surface area, potentially increasing the rates of weathering and leaching both within the backfill and the surrounding mine walls.

The presence of exploration drifts and adits may provide an opportunity to measure compositional differences between whole rock and fractures and talus, rates of weathering and the resulting drainage chemistry prior to mine development.

#### 7.11.7.2 Prediction during Excavation

During construction, mining and processing, it would be important to perform regular operational sampling and analysis, kinetic testing and monitoring of weathering and resulting drainage chemistry on:

- backfill;
- final walls; and,
- notable areas or masses of talus, fractures, blasted materials left in the excavations.

The results could be tracked and recorded, with regular reviews conducted of the existing excavations and future mine plans to identify when final mine walls will be exposed and any changes in proposed final wall locations. In addition to the analyses, testing and monitoring, the data collected could include:

- surveys of the elevations and dimensions; and
- visual descriptions of geologic features.

Operational sampling, analysis, test work and monitoring of backfill should follow the procedures for waste rock, tailings products and other backfill sources, with modifications for any differences in materials handling, reprocessing, amendments or segregation.

Characterization of the final mine walls typically consists of sampling and analysis of rock chips collected along a transect over an area or mass. The number and spatial distribution of composited sub-samples and the transect width will depend on factors such as the geology and mining practices. A typical transect width is that of a drift, which is approximately 4 to 5 m.

The monitoring of drainage from seeps and mine wall stations can be used, along with

*The monitoring of drainage from seeps and mine wall stations can be used, along with compositional data, to characterize weathering and the resulting drainage chemistry of backfill and final walls.*

compositional data, to characterize weathering and the resulting drainage chemistry of backfill and final walls. Changes in surface composition due to weathering should be monitored on representative materials where access is still available. Field test pads should be located in accessible locations for materials

that are going to become inaccessible. Monitoring the rate of flow and chemistry of noticeable drainage inputs, flow paths and discharges would create a water balance and to assist the drainage chemistry prediction. Drainage monitoring should include process water added with backfill and drainage pumped from sumps.

Review of the differences between fine and coarse particles of waste rock with similar geologies as the mine walls may indicate likely mineralogical and geochemical differences between the whole rock and the composition of future fracture surfaces and talus fines.

#### 7.11.7.3 Prediction for Closure Planning and After Closure

At closure, it would be useful if the project had an inventory of the magnitude and composition of:

- walls exposed;
- talus and fractures created;
- backfill;
- other residual materials such as blasting powder, hydrocarbons, galvanized steel or rock that was blasted but left in place; and
- drainage inputs, flow paths and discharges.

Significant changes that occur at closure that may impact prediction or the drainage chemistry include:

- removal of pumps;
- shutting off air supply;
- stopping measures used to maintain access; and
- stopping water inputs through backfill or activities such as drilling.

Monitoring should continue if necessary and possible after closure.

A lack of access soon after the final benches or portions of underground workings are completed may make it difficult to measure properties and processes in flux, such as:

- the rate of oxygen entry;
- drainage input rates and chemistries;
- the magnitude and geochemistry of talus; and
- weathering conditions and rates in talus and backfill.

A lack of access may be due to unsafe air or ground conditions or physical barriers. Unsafe ground conditions after mining ceases may result from a:

- rebound in the water table;
- decrease in the strength of bedrock; and
- lack of maintenance measures to increase ground stability.

A lack of oxygen may restrict entry into underground workings no longer supplied with air.

*Monitoring equipment should be used to check the atmosphere, and breathing apparatus may be required when entering confined mine workings or monitoring locations where there is no air supply.*

Monitoring equipment should be used to check the atmosphere, and breathing apparatus may be required when entering confined mine workings or monitoring locations where there is no air supply.

Physical barriers that prevent access may result from mining activities, flooding or the deterioration in ground conditions. Planned mining activities that create physical barriers include:

- placement of backfill;
- removal of access routes;
- blocking openings to prevent unauthorized entry; and
- building bulkheads to flood portions of the workings.

Access ramps in open pits may be removed by mining or wall failures. Rock failures and local flooding may block adits and access ramps in underground mines. One potential solution to a lack of access by vehicle or foot is to use drill holes to lower monitoring and sampling equipment into closed portions of an underground mine. Examples of the types of remote monitoring include:

- pressure gauges in bulkheads and piezometers to measure the height of flooding;
- monitoring wells to measure the oxygen concentration and temperature; and
- automatic samplers and standpipes to sample water.

Field trials should be constructed in more secure locations to monitor weathering conditions, rates and drainage chemistry where a lack of access prevents in-situ monitoring. Field trials should also be constructed to monitor weathering and drainage chemistry where operational conditions, such as the addition of process water with backfilled tailings, delay weathering.

Field trials should be constructed:

- from a representative range of materials;

- in a location with similar weathering conditions;
- in a location that will remain accessible; and
- as soon as the material is available.

Given the unique temperature conditions underground, if possible, field trials used to predict or monitor the performance of underground materials should be located in a portion of the underground workings that will remain accessible during and after mining.

#### 7.11.7.4 Dealing with Uncertainty

A major challenge in the prediction of drainage chemistry from excavations is the uncertainty regarding many potentially important properties and processes. These include uncertainty in the following:

- final mine plan;
- rate and location of mass wasting and subsidence;
- location, drainage inputs and discharge through fractures and drill holes; and
- future atmospheric and drainage conditions, such as the oxygen supply, flooding and leaching.

This in turn results in uncertainty regarding:

- location of final mine walls;
- impact of subsidence and wall collapse on drainage inputs, discharge locations and flow paths;
- particle surface area and geochemical composition of the talus;
- drainage losses through fractures, drill holes and down gradient discharge locations;
- oxygen supply; and
- rates of leaching and flooding in different areas of the workings and the backfill.

The difficulty in measuring and predicting many key properties and processes in open pits and underground workings may mean there are a number of potential outcomes regarding the chemistry, locations and rates of discharge (Price, 2004 and 2005). If possible, the prediction program should identify gaps in understanding and address them through additional prediction, sensitivity analysis, monitoring, studies, adaptive management and contingency plans (Chapter 3).

Mine plans often change (Section 3.14), for example the location of the final mine walls may be changed. Changes to mine plans may also alter drainage and air inputs and outputs, potentially altering weathering and leaching conditions. The predicted geochemistry of fracture surfaces and talus fines and the resulting drainage chemistry from mine workings need to be updated whenever there are changes to mine plans. Until the final walls are excavated, kinetic studies should be conducted on materials covering the range in the potential wall composition.

Uncertainties regarding the rate and location of mass wasting and subsidence will contribute to the uncertainty regarding local drainage, air, flow, weathering and leaching conditions. Mass wasting, subsidence and the collapse of backfill will increase the surface area available for weathering and may change the rate of air entry, drainage conditions and the rates of weathering and leaching. For example, a large underground rock fall may block drainage, thus flooding and

minimizing weathering in one area while diverting drainage and increasing the leaching of weathering products in another part of a mine. Surface subsidence will increase air and drainage inputs, at least in some portions of an underground mine.

Another source of uncertainty regarding air movement and drainage inputs and outputs is the uncertainty regarding whether fractures and drill holes in the mine workings are connected to the surface or to other regions of the mine workings. Ground collapse may increase these connections, changing air movement and water inputs and outputs and altering the weathering and drainage conditions.

#### 7.11.7.5 Prediction Errors

A common error in past predictions for excavations has been the erroneous classification of rock as “lacking sulphides and therefore not capable of generating deleterious drainage” based on:

- geologic models of the area of mineralization;
- extrapolation of analytical results from rock of similar lithology; or
- visual assessment of the sulphide concentration in drill core or mine walls.

Geologic models, extrapolation of results and visual assessments are potentially inaccurate. Therefore, detailed laboratory analysis and testing of spatially and geologically representative samples would be useful in determining geochemical properties such as the sulphide concentration, predicting the drainage chemistry and assessing whether the drainage chemistry will have a potential environmental impact (Price, 2004).

Another previous prediction error in excavations has been the failure to account for residual materials such as blasting powder, hydrocarbons, galvanized steel or rock that was blasted but left in place when the mine closed.

#### 7.11.8 Additional Prediction Guidelines for Waste Rock and Waste Rock Dumps

Potentially important properties of waste rock and waste rock dumps, and processes occurring therein, that need to be considered in the prediction of drainage chemistry include the following (Section 7.4):

- waste rock can include a large number of different rock types with different geochemistries, susceptible to different weathering reactions and producing very different drainage chemistries;
- the volume of waste rock and the height and width of waste rock dumps can be very large;
- waste rock has a wide range in particle size, ranging from car to dust size;
- coarse sized particles constitute typically 70 to 90% of the waste rock mass but a relatively small proportion of the mineral and particle surface area exposed to weathering;
- fine sized particles typically contain most of the mineral and particle surface area, and therefore the drainage chemistry from waste rock is primarily a function of their geochemical composition, weathering and leaching;
- particle size segregation and compaction during excavation, movement and deposition of waste rock can result in large differences in particle size distribution and structure in different layers or depths of a waste rock dump;

- portions of a dump may experience relatively little leaching; and
- flushing occurs seasonally and during high flow events, and the extent may vary from year to year.

Information on the masses and distribution of different rock types, along with the physical, atmospheric, drainage and geochemical properties of the site, waste rock and dump will be needed to:

- select sampling and analysis procedures;
- scale-up test work results; and
- determine the contribution of the different geologic types of waste rock to weathering and leaching and the drainage chemistry and loadings as a whole.

There can be a wide range of potential construction uses and disposal options for waste rock in addition to placement in dumps.

*There can be a wide range of potential construction uses and disposal options for waste rock in addition to placement in dumps. Much of the waste rock may be used as backfill and in constructing dams, foundations, runways and roads.*

Much of the waste rock may be used as backfill and in constructing dams, foundations, runways and roads. It would be useful to make a comprehensive inventory of all the

rock types and their uses and forms of disposal on the site.

The relatively low rate of leaching compared to the rate of sulphide oxidation in large waste rock dumps can result in:

- progressive accumulation of weathering products;
- formation of cemented layers; and
- solute concentrations that depend on secondary mineral precipitation/dissolution rather than the rate of sulphide oxidation.

Where the rate of leaching is far lower than the rates of sulphide oxidation, an increase in the inflow rate or a change in chemistry that enhances the ability of drainage to dissolve weathering products may increase the concentrations and loadings of contaminants even if there is a decline in the rate of sulphide oxidation.

The accumulation of weathering products and heat from sulphide oxidation will be a function of the distance to the surface. Heat storage and the accumulation of weathering products will be lower at the surface of a dump and where thin layers of waste rock have been used to construct well-flushed foundations, runways and roads. Where the depth of waste rock is relatively thin, atmospheric properties and processes and mixing with underlying geologic materials may have a larger influence on weathering conditions and the resulting drainage chemistry.

The large diameter and proportion of coarse waste rock fragments have a large influence on the properties of waste rock, processes occurring therein, and the resulting predictions. For example, predominantly coarse waste rock dumps can be assumed to be well drained, with high air permeability, convective air movement and aerobic weathering conditions, unless the dump is located in a flooded impoundment, water body or area of drainage discharge.

Information on the particle size distribution, particle surface area and particle breakdown of waste rock may be needed to:

- scale-up test work results;
- predict future geochemical, atmospheric and drainage properties; and
- determine the contribution of different rock types to the drainage chemistry and loadings.

The large size and weight make it very difficult to collect, sample and measure the mass of the largest waste rock particles from underground mines and the boulder sized coarse fragments from open pit mines. The upper limit of coarse fragments in samples of waste rock is typically stone sized (~ 12 cm).

#### 7.11.8.1 Materials Used for Analysis and Test Work

The objectives in sampling waste rock or materials that will become waste rock are to:

- determine spatial, geologic and particle size differences in composition; and
- obtain materials for kinetic weathering tests.

Waste rock analyses and test work are done on different types of material during different stages or phases of a project, including the following:

- pre-mine on drill core and materials excavated from exploration adits or bulk samples;
- pre-blast on blast hole cuttings;
- post-blast on waste rock from the excavation faces or the disposal location; and
- post-disposal on waste rock from holes and trenches in dump surfaces or drill chips from holes drilled in the dump.

The objective of each phase of analysis and test work is to fill information gaps and verify previous results regarding important spatial, geologic and physical properties.

Since coarse fragments typically make up the majority of the waste rock mass and fine particles have most of the mineral surface area and potentially different mineralogy, it is important to identify whether the analysis and test work are from samples of the entire particle size distribution or a specific particle size. Drill core and blast hole cuttings, the two most commonly sampled materials, represent entire particle sizes. Rock chip samples taken from mine walls or surface bedrock exposures also represent entire particle sizes.

#### 7.11.8.2 Prediction Prior to Mining

Prior to mining, geologic descriptions, block modeling and the mine plan can be used to estimate:

- locations and masses of different geologic types of bedrock that will become waste rock;
- when different areas and geologic types of waste rock will be excavated;
- where and how different zones and geologic types of ore rock will be stored; and
- where different zones and geologic types of waste rock will be placed within waste rock dumps.



The locations of different geologic types of bedrock should be shown on geologic maps and cross sections of the excavations and future dumps.

Prior to mining, exploration drill core usually provide the best spatial coverage of the materials that will become waste rock. This information from drill core can be supplemented by information from samples of:

- waste rock from exploration adits and bulk samples; and
- weathered rock outcrops and non-lithified surficial materials.

Exploration drill core is primarily located in areas of potentially economic rock and may not

*Exploration drill core is primarily located in areas of potentially economic rock and may not exist for all proposed areas of excavation. For example, drill core may not be available for areas such as the perimeter or bottom of the excavation.*

exist for all the proposed areas of excavation. For example, drill cores may not be available for areas such as the perimeter or bottom of the excavation. Thus, prior to mining, extra drill holes or contingency plans may be required for waste rock characterization.

Prior to mining, it would be useful to conduct kinetic weathering tests on waste rock from exploration adits or bulk samples if these materials exist and have one or more of the compositions that need to be tested. Due to the often limited extent of exploration adits or bulk samples, drill core is likely to be the only source for at least some of the materials whose composition is of concern and may require kinetic testing. Samples of drill core should be crushed to produce the particulate test material needed for kinetic weathering tests such as humidity cells or columns. Analysis of the composition of the coarse and fine size fractions (e.g. size fractions  $>$  and  $<$  2 mm) of the crushed test material should be conducted before and after the kinetic test.

Prior to mining, atmospheric and drainage properties and processes that will influence weathering and leaching can be predicted from the following:

- information about the site topography, climate, hydrology and hydrogeology (Chapter 6);
- project plans for the size, location and physical and geochemical properties of the waste rock and waste rock dumps; and
- project plans for site water management.

#### 7.11.8.3 Prediction from Analysis and Test Work on Samples

Prediction of the drainage chemistry based on the analysis and test work results from samples, such as drill core, blast hole or rock chip samples, should consider the degree to which the composition of the samples may differ from that of the finer sized particles that will contain most of the weathering surface area of the resulting waste rock. Geochemical criteria for the classification or segregation of waste rock based on analytical results from drill core and blast hole cutting samples may require correction or safety factors to account for potential differences in composition between the fine sized particles and the “waste rock as a whole”. The correction or safety factors will depend on the mining methods and the properties of the rock.

Prior to mining, prediction of future geochemical differences between the smaller, reactive particles and the whole-rock of different geologic units in the waste rock may be obtained by:

- analyzing the coarse and fine sized particles of waste rock from exploration adits or bulk samples removed for processing test work;
- visual or petrographic analysis of drill cores; and
- slaking or coarse crushing drill core samples to simulate the production of reactive fines by blasting and material handling.

The objective in visual or petrographic analysis will be to distinguish areas with fractures, planes of weakness and weak inter-grain cohesion that are likely to report preferentially to the finer particles from the more cohesive, stronger bedrock. Sub-microscopic techniques, such as scanning electron microscopy, may be needed in conjunction with petrographic analysis to determine if there are mineralogical differences between the different types of rock.

#### 7.11.8.4 Analysis of Blast Hole Cuttings

Blast hole cuttings are spatially and geologically representative of all the materials that will become waste rock. These can be advantageous because time is usually insufficient to sample and analyze the waste rock after a blast, review the results and decide on disposal options. Therefore, analysis of blast hole cuttings is typically used to:

*Blast hole cuttings are spatially and geologically representative of all the materials that will become waste rock.*

- verify pre-mine predictions of geochemical composition;
- make decisions about waste rock segregation and disposal; and
- fill in information gaps where the drill core, exploration adits or bulk samples analyzed prior to mining did not cover the entire spatial distribution or geologic variability or were not in sufficient density.

Other reasons for using the analysis of blast hole cuttings to characterize waste rock are that:

- blast holes are surveyed and their position is accurately known;
- blast hole cuttings are routinely sampled to determine the ore or coal grade, there are savings in time and resources, as well, existing personnel and procedures can be used if the same samples and sample preparation can be used for drainage chemistry characterization;
- mine geologists typically routinely describe the geology of the chips or the surrounding rock;
- samples of a cross section of the cuttings will provide a composite sample of a bench height in that location; and
- the lack of traffic and ground instability makes sampling blast hole cuttings safer and less disruptive to the mining operation than sampling post-blast waste rock at the excavation faces or the disposal location.

The limitation in using the analysis of blast hole cuttings to characterize waste rock is that they do not reflect potential biases among particle sizes (see discussion above). Correction factors and subsequent sampling and analysis of post-blast waste rock are needed to verify predictions of the composition of the finer sized particles based on analysis results from samples of drill core and blast hole cuttings.

#### 7.11.8.5 Prediction during Waste Rock Excavation and Dump Construction

The following observations and measurements can be made during excavation of waste rock and dump construction:

- masses of different geologic units reporting to the waste rock, where and when they were excavated and where, how and when they were placed within waste rock dumps;
- waste rock composition, such as the proportion of fines, Acid Base Accounting results and elemental concentrations;
- waste rock weathering rates;
- methods of dump construction; and
- characteristics and location of structural features in the dumps, such as coarse rock chimneys and rubble zones.

Information on the masses of different geologic units reporting to the waste rock and where and when they were excavated will come from the logging of blast hole cuttings. Information on where, how and when different geologic units were placed within waste rock dumps must come from the records of dump construction.

Information on the waste rock composition will come from regular operational analysis of:

- blast hole cuttings sampled just prior to blasting (Section 7.11.8.4); and
- post-blast waste rock sampled at the excavation face or the disposal location prior to incorporation in the dump.

The primary operational source for information about the composition of waste rock is usually analysis of blast hole cuttings.

Analysis of the post-blast waste rock done on both fine and coarse particle size fractions will indicate whether there are geochemical differences between the:

- relatively reactive finer particle size fractions and the the relatively unreactive coarser particle size fractions, and
- relatively reactive finer particle size fractions and pre-blast drill core or blast hole cuttings from similar locations.

Regular operational sampling and analysis of the finer and coarser particle size fractions of post-

*Regular operational sampling and analysis of the finer and coarser particle size fractions of post-blast waste rock is used to verify criteria for pre-blast drill core or blast hole cutting data for classifying and segregating waste rock.*

blast waste rock is used to verify criteria for pre-blast drill core or blast hole cutting data for classifying and segregating waste rock.

Differences in the composition of pre-blast drill core or blast hole cuttings, which are both whole rock samples, and the finer particle size fraction of the resulting waste rock may result from:

- minerals preferentially reporting to fine sized particles; and/or
- other geochemical variability that affects the finer and coarser sized particles differently.

Fine and coarse particle size fractions are separated by sieving. The diameter of the finer, relatively reactive particle size fraction is somewhat material specific. Most sites use a sieve size around 2 mm to segregate the finer and coarser particle size fractions. It should be noted that 2 mm is the particle size used to segregate soil from gravel in soil science. The rationale that a specific particle size fraction contains most of the reactive surface area is rarely checked.

The relative weight of the fine and coarse particle size fractions will be needed to calculate the whole-rock composition of the post-blast samples so it can be compared with the results from previous drill core or blast hole samples.

The extremely large weight and size of the largest waste rock particles usually makes it practically impossible to measure their percent weight. Due to this logistical problem, typically:

- the upper limit of sampled and analyzed coarser fragments in waste rock samples is stone sized (~ 12 cm); and
- the geochemical composition of the stone sized fraction (~ 12 cm to 12 mm) or the stone and gravel sized fraction (~ 12 cm to 2 mm) is assumed to be representative of the entire coarser sized fraction.

The particle size distribution of post-blast waste rock samples can be measured by conducting more detailed particle size analysis on sub-samples of the coarser and finer sized fractions.

Information on waste rock weathering rates and conditions will come from the monitoring of weathering in:

- laboratory and field weathering (kinetic) tests run on samples of waste rock; and
- completed dumps and other areas of waste rock disposal.

The wetting of a waste rock dump needed to initiate weathering and leaching may take time, especially in dry climates. Therefore, as soon as the identity and composition of the waste rock materials of concern are available, advance field kinetic weathering tests can be established to:

- predict the drainage chemistry;
- measures rates of weathering reactions under site specific conditions; and
- verify results of laboratory tests.

#### 7.11.8.6 Prediction after Dump Construction

The objectives of prediction after dump construction are to:

- determine the composition of waste rock where there was inadequate operational characterization prior to blasting and during excavation; and
- predict and monitor changes in weathering rates and conditions and in the composition of drainage chemistry.

Older mines and a number of relatively recent mines have to predict the composition of completed dumps because they did not operationally determine the composition of waste rock by sampling and analyzing the blast hole cuttings or the post-blast waste rock, and their prediction of future drainage chemistry is inadequate. Ongoing monitoring of weathering conditions and changes in the composition of sulphidic waste rock is commonly needed to verify predictions

*Older mines and a number of relatively recent mines have to predict the composition of completed dumps because they did not operationally determine the composition of waste rock by sampling and analyzing blast hole cuttings or post-blast waste rock.*

regarding drainage chemistry and the timing of geochemical changes such as the onset of net acidic conditions.

Samples can be collected from existing waste rock dumps or other areas of waste rock by digging holes and trenches or by drilling. Advantages of sampling waste rock from

faces exposed by digging holes and trenches include the following:

- there is relatively little breaking of particles; and
- it is possible to observe and selectively sample relatively small weathering and structural features.

End-dumped or push-dumped waste rock spreads from crest to toe and a portion of each truckload will remain at or near the surface. In dumps constructed by the end-dumping or push-dumping of a single bench, representative samples of all the geologic materials will be accessible from shallow trenches or pits excavated by a backhoe.

The main disadvantage of pits and trenches is their limited depth. Representative samples of the entire range in the composition of waste rock may be impossible to collect from shallow trenches or pits from dumps:

- consisting of more than one bench,
- constructed by free dumping, or
- where the drainage chemistry is determined by processes deep in the dump.

An example of a process occurring deep in a dump is the weathering and leaching by acidic runoff and groundwater at the base of the Sulphurets dump in British Columbia (Price, 2005).

Drilling into waste rock dumps is expensive and breaks apart coarse fragments and the resulting samples are primarily fragments of broken coarse particles plus some waste rock fines. Where samples are collected by drilling, it is impossible to measure:

- the particle size distribution;
- the composition of the fine size fraction; and
- surface changes due to weathering and the resulting pore water chemistry.

Sieving, weighing and separate analysis of the finer and coarser particle size fractions are required when characterizing samples from holes but is pointless for samples collected by drilling existing dumps.

One advantage of drilling is that the holes can subsequently be used for monitoring oxygen and temperature at different depths, as well as the height of the water table.

Monitoring of waste rock weathering rates and conditions and the resulting drainage chemistry from laboratory and field weathering (kinetic) test work and from full-scale areas of waste rock disposal should continue if there remains significant uncertainty about drainage chemistry and rates of weathering reactions under site specific conditions.

Information on the rate of coarse particle breakdown and its impact on the particle size distribution, particle surface area and geochemical composition of fine sized particles can be obtained by ongoing sampling and analysis of waste rock in dumps or field test pads.

During and after waste rock disposal, climate stations, snow courses, piezometers, weirs, automatic samplers, standpipes and monitoring wells can be installed in or around the waste rock to monitor atmospheric and drainage conditions, properties and processes that will influence weathering and leaching.

#### 7.11.8.7 Dealing with Uncertainty

There is uncertainty regarding a number of potentially important waste rock properties and processes. These include the following:

- rates of leaching in different regions of a dump;
- the proportion of the mass and composition of boulder sized coarse fragments;
- particle breakdown;
- particle migration;
- dump settling; and
- the location of secondary mineral precipitation.

This, in turn, results in uncertainty regarding:

- depletion of acid producing, acid neutralizing and contaminant releasing minerals;
- future atmospheric and drainage conditions; and
- future weathering rates and preferred flow paths.

Particle breaking, creating new fines and exposing fresh mineral grains, may alter the composition, delay the mineral depletion and change the drainage chemistry from that predicted from the initial geochemical composition of the smaller particles. For example, particle breakdown may continually replenish the supply of neutralizing minerals such as fresh calcite, maintaining neutral pH drainage for far longer than that predicted from the rate of depletion of the relatively low neutralization potential present in the reactive fines. Continual exposure of fresh sulphide grains could affect the sulphide oxidation rates. The relative rate of exposure of potentially acid generating and neutralizing minerals may alter their overall ratio through time.

*Particle breaking, creating new fines and exposing fresh mineral grains, may alter the composition, delay mineral depletion, and change the drainage chemistry predicted.*

Methods for predicting particle breakage include:

- methods for measuring particle strength such as slake tests;
- the monitoring of changes in the composition of waste rock near the dump surface; and
- measuring particle size of test materials before and after kinetic tests.

It would be important that the prediction program identify gaps in understanding and address them through additional prediction, sensitivity analysis, monitoring, studies, adaptive management and contingency plans.

#### **7.11.9 Additional Prediction Guidelines for Tailings**

Potentially important properties and processes that need to be considered in the prediction of drainage chemistry for tailings are listed below (Section 7.6).

- The volume of tailings and the size of tailings impoundments can be very large.
- Tailings solids are largely sand and silt sized particles.
- Tailings may be deposited as a slurry or after thickening or filtering has reduced the percentage of process water.
- The small size of tailings particles and the relationship between particle size and grain size typically results in surface exposure of most of the mineral grains to the pore weathering conditions.
- Tailings have a much higher surface area per unit mass than most waste rock.
- The rate of oxygen supply and oxidation will be reduced and may become negligible below a certain depth.
- There may be significant lateral surface runoff and near surface seepage.
- Low permeability landforms or dams used to store tailings often result in at least partial flooding or saturation.

If possible, prediction should be performed on all types of tailings expected at a project. Differences in the geochemical composition, mineralogy, particle size and hydraulic and atmospheric properties of tailings may result from:

- ore types;
- the reduction in particle size and components of the solids removed and added during the milling process;
- separate disposal of different tailings fractions;
- methods of disposal;
- conditions of the disposal site;
- dewatering and ratio of solid to process water;
- reprocessing;
- amendments; and
- segregation during transportation or after disposal.

Examples of the wide range in types of tailings include the following:

- tailings produced from different ore types with different geochemistries, susceptible to different weathering reactions and producing different drainage chemistries;
- slurry, thickened and filtered tailings;
- physically segregated tailings sands and finer material (slimes), with sand and sulphides accumulating on a beach next to the disposal point and silt and lighter minerals such as carbonates settling downstream;
- sulphide rich tailings fractions, such as sulphide-rich cleaner tailings fraction and the sulphide byproduct of tailings desulphurization;
- cycloned tailings sand used for dam construction or backfilled underground;
- backfilled mill tailings amended with other materials, such as cement or crushed waste rock or borrow materials, to increase their volume or strength;
- desulphurized tailings produced to allow disposal or construction use in an aerial environment; and
- tailings spills.

Potential hydraulic and atmospheric limitations on the rates of weathering and leaching due to the fine texture of tailings that should be considered in the selection of prediction analyses and tests and in the interpretation of results include:

- low rate of infiltration and hydraulic conductivity;
- a raised water table;
- restricted air movement; and
- drainage loss into surrounding, more porous strata.

Restricted air movement may limit the rate and depth of sulphide oxidation, perhaps changing the balance between acid generation and neutralization. The hydraulic conductivity of tailings can be estimated from the particle size, piezometer measurements and pumping tests.

*Restricted air movement may limit the rate and depth of sulphide oxidation, perhaps changing the balance between acid generation and neutralization.*

The prediction of drainage chemistry should include consideration of contaminant migration by:

- lateral surface runoff and near surface seepage;
- wind erosion; and
- vertical seepage down through the tailings.

The dissolved concentrations and migration rates of contaminants by lateral surface and near surface flow may be very different from vertical seepage down through the tailings, due to differences in weathering conditions between the near surface and at depth. The development of cemented layers at or near the tailings surface may further change drainage and weathering conditions and increase lateral surface runoff and near surface seepage.



### 7.11.9.1 Prediction Prior to Processing

Predictions of the composition and drainage chemistry of tailings prior to processing should consider the potential range in the:

- geochemical composition of the ore;
- changes in the composition of sulphides, alkalinity, metals and other components in the tailings solids that will result from milling, reprocessing, amendments and differential settling;
- atmospheric and drainage conditions and rates of weathering, leaching and air entry in different tailings materials and at different depths of an impoundment; and
- chemical composition of the process water.

Prior to construction and operation of the mill, the only tailings material available to measure the

*Prior to construction and operation of the mill, the only tailings material available for testing are the residues from bench and pilot tests of the milling/metallurgical procedures.*

addition, removal and changes in the composition of sulphides, alkalinity, metals and other components in the tailings solids during processing are the residues from bench and pilot tests of the milling/metallurgical

procedures. However, differences between tailings produced by pre-processing metallurgical tests and the actual tailings may result from the:

- limited materials tested;
- scale-up; and
- operational modifications to processing methods.

The potential impact of these differences should be addressed by conducting sensitivity analyses on key properties and processes.

Pre-processing prediction and operational monitoring on the composition of the process water should be considered to identify potentially problematic components such as thiosalts.

### 7.11.9.2 Prediction during Processing and Deposition

The following information and measurements should be recorded or made during processing and during and after deposition of the tailings:

- masses, and physical and geochemical composition, of different types of ore processed into tailings;
- mill and secondary processing methods for different types of ore, including the particle size segregation and reduction, amendments, effluent treatment and extracted components;
- magnitude and geologic, physical and geochemical composition of resulting tailings streams and products;
- disposal methods, location, site conditions and dimensions and the segregation of different sized particles for different tailings streams;
- tailings weathering and leaching rates and conditions and the resulting drainage chemistry and contaminant loads;
- magnitude, chemical composition and disposal methods and locations for process water;

- changes to the chemistry of ponded water; and
- mitigation measures.

Information on the masses and composition of the different types of ore processed into tailings can come from the logging of blast hole cuttings. Information on mill and secondary processing methods for different types of ore and the geologic composition of different tailings streams and products should be included in the processing records. Information on the magnitude and disposal methods and locations for the process water and different tailings streams and products should be included in the waste management records. These records should include information on the magnitude, locations and potential effects on drainage chemistry of tailings spills and any modifications to methods of processing and deposition.

During processing, it would be instructive if there were regular sampling of process water and different tailings streams and products and analyses of their physical and chemical composition. Care should be taken in operational characterization to sample the final tailings and process water within the impoundment after any processes that may change the composition. For example, particle and mineral segregation due to alluvial processes after the deposition of a tailings slurry may have a large impact on their geochemical composition and the resulting drainage chemistry. Also, during active deposition, process water will limit wind erosion making it difficult to predict the post-deposition water balance and masking future drainage conditions.

Air entry and the rates of weathering and leaching in tailings are typically highest in the upper layer of tailings. For post-closure predictions, sampling and analysis of the final, upper layer of tailings in impoundments and other areas of tailings disposal, including any tailings segregation, should be conducted after deposition is complete.

*Air entry and the rates of weathering and leaching in tailings are typically highest in the upper layer of tailings.*

Information on tailings weathering rates and conditions and the resulting drainage chemistry will come from monitoring of weathering in:

- laboratory and field weathering (kinetic) studies; and
- tailings in impoundments and other areas of tailings disposal.

During active deposition, saturation and neutralization by process water may limit weathering in impoundments and other areas of tailings disposal. Therefore, field kinetic weathering tests are needed to predict the drainage chemistry and to measure rates of weathering reactions under site specific conditions and to verify results of laboratory tests. Laboratory and field weathering studies that simulate post-deposition weathering conditions could be built as soon as the identity and composition of the tailings materials of concern are known and these materials are available. Where tailings segregate, weathering studies should test tailings sand and slimes separately.

### 7.11.9.3 Prediction after Deposition

Monitoring of weathering of the actual tailings in impoundments and other areas of tailings disposal can start once deposition ceases, tailings dry out and aerial weathering starts. Test pits

and drilling can be used to collect samples and to monitor the change in surface weathering conditions and the propagation of weathering and contaminant fronts downwards over time.

#### 7.11.9.4 Desulphurized Tailings

Challenges in the prediction and operational monitoring of desulphurized tailings used for construction are:

- prediction of the effectiveness of the desulphurization process prior to the purchase of operational equipment; and
- ensuring sufficiently quick detection of process upsets to enable alternative disposal options before large volumes are placed in sensitive areas.

Mill facilities can sometimes be used for field-scale testing of the desulphurization process. Potential measures for quick detection of process upsets include:

- continuous assays of the mill circuit using on-stream analyzers;
- frequent analysis of grab samples using relatively quick assays, such as total-S and total or inorganic carbon, especially during startup and until the reliability of the process has been demonstrated;
- less frequent full ABA analysis, ICP scan of metals and mineralogical analysis; and
- an Operations Manual with a monitoring plan, provisions for seepage monitoring and QA/QC similar to those conducted for other drainage chemistry characterization and prediction at the site.

For example, if the total sulphur and carbon were measured over a period of 4 hours, with 2 hours added for turn around time for analysis, the worst case would be 6 hours of “off-spec” material being deposited. If desulphurized tailings sand were produced at 400 tonnes per hour, 2,400 tonnes would report to the wrong location over a 6 hour period, if there was an upset in the process.

*For example, with total sulphur and carbon measured over 4 hours, with 2 hours added for sample analysis turn around time, the worst case would be 6 hours of off-spec material.*

Whenever significant modifications occur in the milling and desulphurization processes, it would be important to perform frequent analyses to confirm that there is a consistently acceptable composition before desulphurized tailings are permitted to be placed in sensitive areas.

#### 7.11.9.5 Prediction Errors

Prediction errors commonly occur in pre-process predictions of the composition of the tailings. Some of these are:

- ore samples used in pre-process metallurgical test work to predict geochemical composition of tailings are not representative of the range in geochemical composition of the ore and do not include the materials of greatest concern;
- the process used in metallurgical test work greatly over estimates the removal of sulphide minerals in the operational process; and

- pre-process predictions fail to consider the concentration of sulphide minerals, rapid weathering and greater leaching in the tailings sands and the concentration of carbonate minerals and limited weathering and leaching due to flooding in the tailings slimes.

#### **7.11.10 Additional Prediction Guidelines for Ore and Low Grade Ore**

Pre-development prediction should be considered in order to determine potential drainage chemistry concerns for low grade ore and ore (Section 7.7). If possible operational material characterization and monitoring should be performed to determine the composition of any potentially problematic low grade ore and ore materials stockpiled for a prolonged period of time. Thorough kinetic testing supported by detailed on-site monitoring could be used to determine the time to onset of unacceptable drainage chemistry, if there is a potential for ARD or other forms of significant metal leaching.

Low grade ore and uncrushed ore typically have similar particle sizes and require prediction procedures similar to waste rock (see Section 7.5).

#### **7.11.11 Additional Prediction Guidelines for Wastes and Sediment from Drainage Collection and Treatment**

The materials and methods for prediction and monitoring of the composition of, and drainage chemistry from, waste and sediment from drainage collection and treatment will depend on the (Section 7.8):

- chemistry of the collected and treated drainage;
- drainage collection facilities;
- treatment methods;
- atmospheric, drainage and geochemical properties of the sediment and treatment wastes; and
- atmospheric, drainage and geochemical conditions of the disposal sites for the sediment and treatment wastes.

Potentially important properties of wastes and sediments from drainage collection and treatment and processes occurring therein that need to be considered in the prediction of drainage chemistry include the following.

- Contaminants in sediment and secondary wastes often occur in amorphous, organic, absorbed and other non-mineral chemical phases.
- Redox and pH conditions under which wastes and sediment from drainage collection and treatment form may be very different from those of the disposal environment.
- The chemistries of the collected and treated drainage and therefore the properties of the sediment and treatment wastes, are likely to change over time.
- Long term, post-closure prediction and monitoring will be required at projects with long term, post-closure drainage collection and treatment.

Determination of contaminant species and phases in these materials is an important part of the prediction of future drainage chemistry. Scanning Electron Microscopy (SEM), electron microprobe and other sub-microscopic methods will be required to identify the phases and

speciation of different contaminants when they occur in amorphous form. Leaching tests may be required to determine the conditions and amount of release of adsorbed contaminants.

If possible, prediction of future drainage chemistry from waste and sediment from drainage collection and treatment should include the impact of weathering and leaching processes in flux and during extreme climate events. For example, marked differences between the formation and disposal conditions may result in geochemical instability and lead to rapid weathering and leaching.

#### 7.11.12 Additional Prediction Guidelines for Other Sulphidic Materials

Other sulphidic materials requiring prediction include borrow materials needed for construction

*Other sulphidic materials requiring prediction include borrow materials needed for construction and materials that have precipitated or have been adsorbed from previous sulphidic drainage.*

and materials that have precipitated or have been adsorbed from previous sulphidic drainage (Section 7.9). Elevated concentrations of sulphide minerals or their oxidation products are common in many geologic materials close to, and often at some distance from, a mine site.

Finding environmentally safe construction materials is an important part of project planning. Prediction and monitoring of the composition and future drainage chemistry of borrow materials used for construction is potentially a very important part of a comprehensive pre-development, operating and post-closure prediction program.

Materials that have precipitated or have been adsorbed from previous sulphidic drainage may be a potentially large contaminant source at historic sites. The determination of chemical speciation and chemical phases in amorphous materials that have precipitated or been adsorbed from previous sulphidic drainage requires similar methods to those needed for the amorphous residues of drainage treatment (see Section 7.11.11).

#### 7.11.13 Additional Prediction Guidelines for Co-Disposed Wastes

An inventory of the physical and chemical composition, disposal locations and subsequent geochemical and hydrogeologic conditions is needed to predict the drainage chemistry of co-disposed materials (Section 7.10).

### 7.12 References

Birkeland, P.W. 1974. Pedology, Weathering and Geomorphological Research. Oxford University Press. p. 285

Blowes, D.W., C.J. Ptacek and J. Jurjovec. 2003. Mill Tailings: Hydrogeology and Geochemistry - Chapter 5. In: J.L. Jambor, D.W. Blowes and A.I.M. Ritchie. (eds.) Environmental Aspects of Mine Wastes. Mineralogical Association of Canada Short Course Series, Volume 31.

- Carroll, D. 1970. Rock Weathering. U.S. Geologic Survey. New York-London: Plenum Press.
- Choquette, M. and P. Gélinas. 1994. Mineralogical Transformations Associated with AMD Production in a Waste Rock Dump, La Mine Doyon – South Waste Rock Dump. MEND Report 1.14.2f (not released).
- Gartner Lee Limited. 2002. Rose Tailings Facility 2001 Hydrogeologic and Geochemical Investigation, Faro Mine, Yukon, March.
- McKeown, R., L. Barbour, D. Rowlett and G. Herasymuik. 2000. Characterization of the Grain Size Distribution for Waste Rock from Metal Mines – A Review of Existing Data and an Evaluation of the Implications for Hydrogeologic Behavior. In: Proceedings of the 28th Annual Conference of the Canadian Society for Civil Engineers, London, Ontario, June 7-10.
- McLaren, W.A. 1986. Modeling of Flow Through A Mine Waste Dump. In: Proceedings of the International Symposium on Flow-Through Rock Drains. British Columbia Technical and Research Committee on Reclamation, Cranbrook, British Columbia. September 8-11.
- Mehling Environmental Management Inc. 2006. Paste Backfill Geochemistry – Environmental Effects of Leaching and Weathering. MEND Report 10.2.
- Morin, K.A. and N.M. Hutt. 2004. Equity Division – Review of 2003 ARD and Assessment of ARD Mechanisms. Prepared for Mike Aziz, Equity Division, Placer Dome Canada.
- Morin, K.A. and N.M. Hutt. 2006. The MEND Minewall Technique: Overview and Details. In: Proceedings of 13th Annual British Columbia-MEND Metal Leaching / Acid Rock Drainage Workshop, Challenges with Open Pits and Underground Workings., Vancouver, British Columbia, November 29-30.
- Morin, K.A., E. Gerencher, C.E. Jones and D.E. Konasewich. 1991. Critical Literature Review of Acid Drainage from Waste Rock. MEND Report 1.11.1.
- Morwijk Enterprises Ltd. 1995. MINEWALL 2.0. Series of four reports (User's Manual, Literature Review, Application of MINEWALL 2.0 to Three Minesites, and Programmer's Notes and Source Code). MEND Report 1.15.2.
- Nichol, C., L. Smith and R. Beckie. 2005. Field-scale Experiments of Unsaturated Flow and Solute Transport in a Heterogeneous Porous Medium. Water Resources Research. 41, W05018, doi: 10.1029/2004WR003035.
- Phillip, M. and D. Hockley. 2007. Sullivan Fatalities Incident Technical Investigations and Findings. In: Proceedings of the 14th Annual BC MEND Metal Leaching/Acid Rock Drainage Workshop, Challenges in Collection and Treatment of Mine Drainage. Vancouver, British Columbia, November 28-29.

Price, W.A. 2004. List of Potential Information Requirements in Metal Leaching and Acid Rock Drainage Assessment and Mitigation Work. MEND Report 5.10E.

Price, W.A. 2005. Case Studies of ML/ARD Assessment and Mitigation: Snip Gold Mine. MEND Report 9.1c.

Price, W.A. 1989. Factors Affecting Vegetation Establishment at the Kitsault Minesite. Ph.D. Thesis, Department of Soil Science, University of British Columbia. p. 416.

Price, W.A. and L.M. Lavkulich. 1988. Predicting the Effects of Weathering on Waste Rock Soil Properties at the Kitsault Minesite. In: Proceedings of 13th CLRA Convention, Ottawa, Ontario, August.

Price, W.A. and Y.T.J Kwong. 1997. Guidelines for the Prediction of Acid Rock Drainage and Metal Leaching for Mines in British Columbia. Part III. Waste Rock Weathering, Sampling and Analysis: Observations from the British Columbia Ministry of Employment and Investment Database. In: Proceedings of the Fourth International Conference on Acid Rock Drainage, Vancouver, British Columbia, May 31 - June 6, 1997. Vol 1: 31-45.

Ritchie, A.I.M. 2003. Oxidation and Gas Transport in Piles of Sulfidic Material - Chapter 4. In: J.L. Jambor, D.W. Blowes and A.I.M. Ritchie (eds.) Environmental Aspects of Mine Wastes. Mineralogical Association of Canada Short Course Series, Volume 31.

Smith, L. and R. Beckie. 2003. Hydrologic and Geochemical Transport Processes in Mine Waste Rock - Chapter 3. In: J.L. Jambor, D.W. Blowes and A.I.M. Ritchie. (eds.) Environmental Aspects of Mine Wastes. Mineralogical Association of Canada Short Course Series, Volume 31.

Younger, P.L., S.A. Banwart and R.S. Hedin. 2002. Mine Water: Hydrology, Pollution, Remediation. Kluwer, Dordrecht, The Netherlands. p. 442.





## 8.0 SELECTION, STORAGE AND PREPARATION OF SAMPLES

### *Some Important Points in this Chapter*

*The selection, storage, and preparation of samples are critical steps in the prediction of drainage chemistry from sulphidic geologic materials. If a sample is not selected and stored properly, all the remaining time and cost spent on analyses and interpretations could be wasted. Careful decisions must be made on many issues, such as which material to sample, the method and frequency of sampling, the appropriate volume of the sample, whether to crush or grind the sample, substitution of samples from other sources and separation of coarser less reactive particles from finer more reactive ones. Each sample should be described in detail and preferably geo-referenced to a location and depth at the mine or project. For example, samples of blast hole cuttings are often geo-referenced and placed in site geologic models. Characteristics like colour may provide some indication of weathering, leaching and oxidation to guide sampling, but colour is not always reliable.*

### 8.1 Introduction

One of the most important parts of any prediction program is the selection, storage and preparation of samples for analysis or test work. The objective in sample selection, storage and preparation is to enable analysis or test work that will indicate the magnitude and significant variability in the targeted properties of the materials. Sampling should occur during all stages of a project from exploration to post-closure (Chapter 4). Sampled materials include the geologic materials, the resulting waste materials and project components and the associated drainage and gas phases (Chapters 6 and 7).

*The objective in sample selection, storage and preparation is to enable analysis or test work that will indicate the magnitude and significant variability in the targeted properties of the materials. Sampling should occur during all stages of a project from exploration to post-closure.*

Every prediction program is faced with questions regarding:

- which materials to sample;
- where, when and how often to sample;
- what type, dimensions and weight of samples to collect; and
- what sample storage and preparation is needed prior to analysis and test work.

The answers to these questions will be site and project specific and will depend on the:

- prediction objectives (Chapter 2);
- geologic materials, waste materials, excavations and project components (Chapters 6 and 7);
- stage of project development (Chapters 4 and 7);
- stage of prediction (Chapter 4);
- timing of management actions and regulatory decisions (Chapter 3);

- phase being sampled (e.g. solid, liquid or gas);
- potential analyses and test work and the properties and processes they are intended to measure (e.g. composition of the < 2 mm size fraction of waste rock, or dissolved portion of the total drainage concentrations);
- accessibility of representative material;
- ability to collect and prepare samples without changing the targeted properties and processes;
- variability of the targeted properties and processes; and
- accuracy and precision required of the prediction.

Many of the factors listed above are inter-related. The types of representative material (e.g. drill core) accessible for sampling will depend in part on the stage of project development (Chapter 4). The targeted phases, properties and processes will depend on the prediction objectives, stages of project development and the waste material or project component.

The largest sampling campaigns are typically to:

- predict the composition of sulphidic waste materials, excavations and other project components (Figures 4.4a. and 4.4b); and
- monitor drainage chemistry and contributing physical, atmospheric, drainage and geochemical properties and processes.

Owing to the significant cost and the importance of the resulting data, a proponent is advised to carefully consider the sampling requirements of each site and project and discuss the sampling program with regulatory agencies prior to its implementation.

## 8.2 Which Material to Sample

The decision about which material to sample depends on the availability of material and on the information the material can provide. The information a solid phase sample can provide depends on how representative it is of the physical and geochemical composition that will determine the drainage chemistry. This includes changes due to excavation, processing and deposition, and previous weathering and leaching. Changes in composition include changes in particle size and in the mineral content and exposure to weathering. Changes in mineral content may result from the segregation of different sized particles and mineral addition, removal, weathering and precipitation.

Different materials can provide different information. For example, geochemical analysis of fractured drill core that has been exposed for different periods of time may provide information on the rates of mineral weathering at the site. Comparison of fresh and previously exposed tailings with a similar initial composition may provide information on the rates of mineral weathering, the resulting weathering conditions and the fate of weathering products.

*Geochemical analysis of fractured drill core that has been exposed for different periods of time may provide an estimate of mineral weathering rates.*

Availability and accessibility play a large role in determining which materials are sampled during different stages of a project. Where possible, the actual materials should be sampled. However, waste materials and project components may not exist or be accessible during different stages of the mine life, so this is not always possible. For example, there will be no full-scale waste rock dump, excavations or tailings areas to sample prior to excavation and processing. Other examples are provided below.

- Prior to mining, the choice of material to sample is often restricted to drill core and to metallurgical testing for tailings.
- After waste rock dump construction, it may be practically impossible to retrieve intact particles from below a certain depth.
- During tailings deposition, a lack of surface strength may make it impossible to sample segregated tailings sand and slimes.
- After portions of excavations are completed, a lack of access may make it impossible to monitor talus production and composition, weathering conditions and resulting drainage chemistry.

Limitations in the availability and accessibility of materials to be sampled need to be considered in the design of a sampling program. Sampling to fill information gaps should be conducted when the opportunity arises. For example, as part of operational characterization, the fine fraction of waste rock could be sampled and analyzed to verify previous predictions of drainage chemistry based on drill core or blast hole cuttings.

Various materials may be added or removed or their exposure may be changed during processing and waste handling. It is important when conducting operational characterization of waste materials and project components that sampling occurs after any reprocessing, amendments, physical or mineral segregation and other forms of disturbance that may alter the composition and resulting drainage chemistry.

### **8.3 Where, When and How Frequently to Sample**

Where, when and how frequently to sample will depend on the:

- existing information;
- where and when representative material is available;
- timing of management actions and regulatory decisions;
- variability of the targeted properties and processes; and
- required accuracy and precision.

Selection of geologic sample sites should be based on a good knowledge of the deposit. The location of geologic materials with notable differences in physical, mineralogical, geochemical, weathering and leaching properties and the likely boundaries of the waste and ore within pits and underground workings should be identified prior to sampling. Prior to mining, deposit knowledge may come from exploration, regional geologic surveys and environmental baseline work.

Geologic materials with significantly different physical, mineralogical, geochemical, weathering and leaching properties should be separated into discrete “units” (e.g. geologic units, Sections 6.6.4 and 6.6.5). Where differences in potentially important physical, mineralogical, geochemical, weathering and leaching properties occur irregularly or along continuums, geologic materials, waste materials, walls and project components should be divided into “management” units.

The sampling program should include good spatial, geologic and geochemical representation. Spatial representation of geologic materials may be achieved by collecting samples at regular intervals across the width and depth (horizontally and vertically) of proposed excavations and the resulting waste materials, walls and other project components. Good geologic and geochemical representation may require additional targeted sampling (e.g. randomly stratified) within discrete geologic or waste units with notably different physical (e.g. highly fractured), mineralogical (e.g. mineral alteration), weathering (e.g. oxidized) and leaching (e.g. supergene enrichment) properties.

Potential impediments when sampling geologic materials in proposed excavations include a lack of drilling in less accessible (e.g. deeper) regions and in waste material a long distance from the zone of economic mineralization.

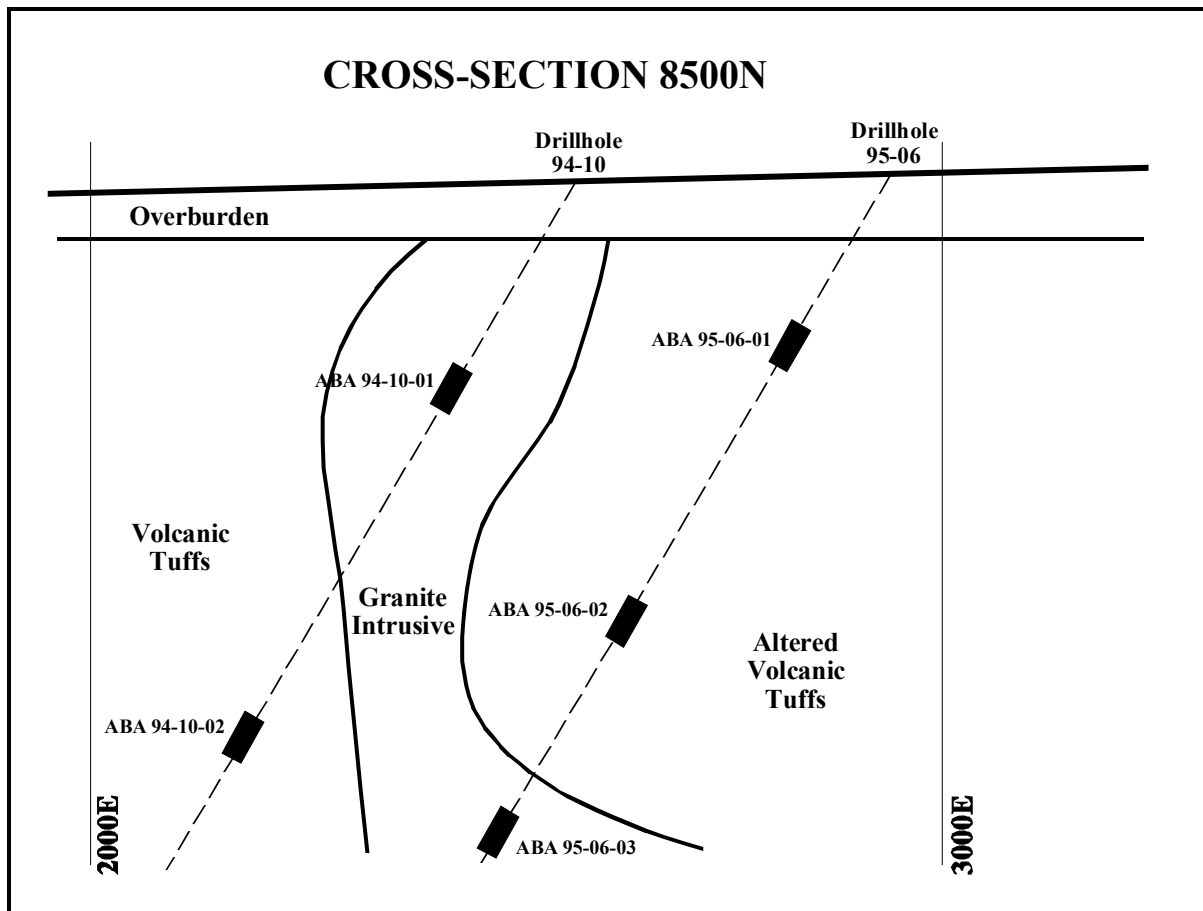
Potential impediments when sampling the resulting waste materials, walls and other project components later in the mine life include:

- the limit in the depth that holes or trenches can be dug to remove intact samples of waste rock from existing dumps (Section 7.11.8); and
- a lack of access may make it impossible to collect samples from active tailings impoundments (Section 7.11.9) and closed, un-maintained portions of a pit or underground workings (Section 7.11.7).

It is important to provide good spatial, geologic and geochemical representation because contaminant discharge may be produced by only a portion of the geologic material. For example, high concentrations of metals in neutral pH drainage may result from acidic weathering in localized, relatively small portions of the overall mass of material. Samples should be collected from any potentially significantly sized mass of material with properties that may notably affect the drainage chemistry (Section 4.4.1).

*It is important to provide good spatial, geologic and geochemical representation because contaminant discharge may be produced by only a portion of the geologic material.*

Visual observations, geologic models or a geologist's experience can be a guide as to the potential composition of unsampled regions of geologic materials, waste materials and walls, but must always be verified by comprehensive sampling and analysis.



**Figure 8.1** Example of required geologic cross sections showing the location of core samples.

Sampling sites for pre-mine drill core, blast hole cuttings and post-blast waste rock should be recorded in block models (Figures 6.6 and 6.7) and shown on cross sections and plan view maps (Figure 8.1). If possible, cross sections and maps should also show the location of:

*Sampling sites for pre-mine drill core, blast hole cuttings and post-blast waste rock should be recorded in block models and shown on cross sections and plan view maps.*

- drill holes;
- discrete geologic units and other more diffuse forms of alteration such as mineralization, hydrothermal alteration, weathering or leaching;
- proposed project components, such as open pits or underground excavations; and
- existing disturbances.

The large number of potentially influential physical, mineralogical, geochemical, weathering and leaching properties and processes can make sampling geologic materials, waste materials and walls an onerous undertaking. Commonly, the most cost-effective way to characterize geologic materials, waste materials and walls will be an iterative phased process of sampling and analysis,

similar to that used to determine other geologic characteristics such as ore reserves. Ideally, there will be several phases to ensure that sampling:

- focuses on the materials of greatest concern;
- minimizes work on materials with no significant uncertainty;
- uses the most appropriate materials and methods; and
- makes timely refinements in response to unforeseen conditions.

Sufficient numbers of samples should be taken to accurately characterize the variability and

*Sufficient samples should be taken to accurately characterize the variability and central tendency, like the average, median and 10<sup>th</sup> and 90<sup>th</sup> percentiles.*

central tendency (e.g. average, median and 10<sup>th</sup> and 90<sup>th</sup> percentiles) of the different waste materials, project components and geologic units. This includes characterization of localized areas of material with differences in physical,

geochemical, mineralogical, weathering and leaching conditions that alter drainage chemistry. The required sampling frequency will depend on the phase of the project, mass of material, variability of critical parameters, the questions being asked and the degree of accuracy required for each project component.

The sampling frequency should be based on a review of:

- results of previous prediction sampling and analysis;
- descriptions of the materials exposed on surfaces and intercepted by excavations or drilling (Sections 6.6.4, 6.6.5 and 6.6.6);
- sampling frequency required to characterize other geologic properties such as the geotechnical properties or ore grades; and
- results of any previous analyses of other geologic properties.

Sensitivity and gap analyses should be conducted after every phase of sampling to:

- check whether the proposed sample selection, storage and preparation will still answer prediction questions; and
- identify information gaps and evaluate their impact on the overall environmental risk and liability.

Each phase of sampling should be informed by the previous campaigns. Sampling needs will become more clearly defined with project development and improvements in the understanding of the geologic materials and site conditions. Procedures that should be used to check whether sampling frequencies are adequate are:

- regular comparison of geologic descriptions and analytical results of samples from within supposedly homogeneous materials;
- periodic nested sampling in between regular sample intervals; and
- periodic random sampling in addition to regular sample intervals.

Descriptions of the sample geology should also be compared with geologic descriptions of the materials the samples are supposed to represent. Analytical results for nested and random

sampling in between regular sample intervals should be compared with analytical results for regular sample intervals.

Changes in project plans and the properties that control drainage chemistry may necessitate changes in sample preparation and storage and the location, time and frequency of sampling. Gaps in sampling of waste materials, project components, geologic units and different physical, mineralogy, weathering and leaching conditions that may alter drainage chemistry should be recorded and included in the next phase of sampling.

*Gaps in sampling should be recorded and included in the next phase of sampling.*

Suggestions regarding the initial sampling frequency are provided in Tables 8.1 and 8.2. Table 8.1 illustrates the recommended phased approach to sampling and provides guidance on the initial number of samples and test work during different stages of exploration, pre-feasibility and feasibility stages of a project. There is no consideration of the mass of material in Table 8.1 and no consideration of phased sampling in Table 8.2. Regardless of the starting point, the final sampling frequency should be determined site specifically based on the variability of analytical results for critical parameters, prediction objectives and required accuracy.

**Table 8.1 Suggested initial number of samples and test work (adapted from Australian Government Department of Industry, Tourism and Resources, 2007).**

<b>Phase</b>	<b>Description</b>
Exploration: prospect testing	At least 3 to 5 representative samples should be tested for each key lithology/alteration type.
Exploration: resource definition	At least 5 to 10 representative samples should be tested for each key lithology/alteration type.
Pre-feasibility	Several hundred representative samples of high and low grade ore, waste rock and tailings should be collected for geochemical work. Sufficient samples to populate a block model with a reliable distribution of static test data on ore, waste and wall rock. Kinetic tests should be established for at least 1-2 representative samples for each key lithology/alteration type.
Feasibility	Continue to refine block models. Review previous geochemical data for high and low grade ore, waste rock and tailings. Improve density of data for block model if necessary and conduct sufficient mineralogical test work to cross check data for key lithologies. If there are insufficient data to assess drainage chemistry and provide a convincing management plan for approval, additional sampling, test work and refinement of block models will be required.

Table 8.2 provides a suggested initial sampling frequency based on tonnage of disturbed rock when sampling a geologic unit or a mine component without any prior information to use as a

*The recommendation here and previously is that the final sampling frequency be determined site specifically based on the variability of critical parameters, prediction objectives and required.*

guide. In the past, the sampling frequencies in Table 8.2 have been incorrectly described as “the recommended sampling frequency in British Columbia” without indicating that this is only a suggested starting point and is not the

required final number of samples. The recommendation here and previously is that the final sampling frequency be determined site specifically based on the variability of analysis results for critical parameters, prediction objectives and required accuracy. Despite previous misrepresentation, Table 8.2 is a potentially useful starting point and has been retained for this purpose.

**Table 8.2 Suggested initial sampling frequency based on tonnage when sampling without prior information (adapted from BCAMDTF, 1989).**

<b>Tonnage of Unit (metric tonnes)</b>	<b>Minimum Number of Samples</b>
< 10,000	3
< 100,000	8
< 1,000,000	26
< 10,000,000	80

#### 8.4 Dimensions to Sample

The area, volume or length of each individual sample or over which sub-samples are composited

*The area, volume or length of each individual sample should be based on practical considerations and properties contributing to drainage chemistry.*

should be based on practical considerations and properties contributing to drainage chemistry. Practical considerations include properties of the material being sampled (e.g. drill core) and sampling and handling constraints. Functional dimensions of

the properties contributing to drainage chemistry will depend on:

- weathering and leaching properties of geologic material, waste material and project component whose drainage chemistry is being predicted;
- magnitude dimensions of spatial variability in targeted properties and processes;
- distance over which mixing occurs during extraction, processing and deposition; and
- prediction objectives, and the required accuracy and precision.

Due to mixing during extraction, processing and deposition, a “geochemical” or “mining” functional area or length may be a:

- bench for an open pit;
- adit or drift rock face and a muck pile for underground workings;
- the minimum depth or volume that could be segregated if separate disposal or mitigation were required;



- single lift for a waste rock dump; and
- slimes and sands from a single period of deposition for tailings.

The minimum depth or volume that could be segregated in an open pit or underground workings will depend on the mining methods, the geologic stratigraphy and the size of the equipment. Relatively thin layers may be segregated and should be sampled separately in coal and underground mines.

Compositing of material from different locations will improve the prediction of the overall central tendency but may mask significant variability in physical, mineralogical, geochemical, weathering and leaching properties. This can result in the misclassification of potentially problematic material and a failure to detect significant changes in properties that will affect drainage chemistry. Since variability typically has a greater affect on drainage chemistry than the central tendency, compositing should be avoided for samples taken:

*Compositing of material from different locations will improve the prediction of the overall central tendency but may mask significant variability in physical, mineralogical, geochemical, weathering and leaching properties.*

- at different times;
- over wide distances; and
- from different geologic units and waste or wall material with significant variability in physical, mineralogical, geochemical, weathering and leaching properties.

The distance beyond which compositing of sub-samples should be prohibited will depend on the material, prediction question, spatial variability in the property being measured and the required accuracy and precision. Compositing over a bench height and distances of four or five meters may be acceptable when characterizing freshly blasted waste rock from a single geologic unit with relatively homogeneous conditions. Compositing should not occur for materials with different composition or weathering conditions, such as different geologic strata in a coal deposit or weathering fronts in tailings, unless there will be thorough mixing in the future.

Where there are concerns about compositing, a portion of each sub-sample could be stored to allow separate analysis should it become necessary to determine smaller scale variability. For example, a program of testing drill core samples, prepared by compositing over a length equivalent to the bench height, could include periodic analysis of discrete sub-samples.

## 8.5 Sample Mass

The minimum sample mass or volume that needs to be collected will depend on the requirements for analysis and testing. Additional material beyond the minimum should be collected in case there are additional analyses, test work or QA/QC requirements (e.g. replicate testing).

The initial sample mass needed will depend on whether analyses and test work will be conducted on:

- the sample as a whole; or
- different particle size fractions, separated by sieving.

Where analyses and test work will be conducted on different particle size fractions, the mass must be large enough for analyses and test work on the size fraction that is the smallest mass. For example, waste rock samples may need to be 10 kg or more to provide 2 kg of the < 2 mm particle size fraction.

*Where analyses and test work will be conducted on different particle size fractions, the mass must be large enough for analyses and test work on the size fraction that is the smallest mass.*

Five hundred grams is typically needed to conduct a comprehensive list of static tests, with 1 kg being preferred. The minimum mass of material needed to conduct a laboratory kinetic test is a minimum of 2 kg, with 3 kg preferred, in addition to the minimum of 500 g for pre-kinetic static tests. Larger kinetic tests will typically require several kilograms to many tonnes depending on the design of the test.

## 8.6 Sample Description

Every sample should have a unique name and number that can be used to identify the sample in the field, laboratory and during data analysis.

It is also very important that a description be provided with each sample. The description should include the following:

- sampling date;
- sampler's name;
- sampling location (GPS coordinates);
- area, volume or length over which each individual sample is collected or sub-samples are composited;
- sample size;
- geologic material;
- waste material and project component;
- type of material sampled (e.g. drill core); and
- visual characteristics such as Munsell colour, visible mineralogy and apparent grain size.

All this information can be critical in the correct interpretation of analytical results.

For mine workings, it is important to know where and when sampled material was obtained to identify the original geologic unit and to mark the time of exposure to distinguish them from earlier samples. The sample location can be used to classify samples and will show where the sample spatially fits within the material it was taken to represent.

*For mine workings, it is important to know where and when sampled material was obtained to identify the original geologic unit and to mark the time of exposure to distinguish them from earlier samples.*

A block model can be used to store sample data, spatially link it to other geologic information and map the results. Block modeling involves conceptually dividing a pit, underground working or waste disposal site into blocks. Geostatistical techniques like kriging are used with analytical

data from drill core to designate each block in a mine as ore or a waste. Similarly, each block can be designated as PAG or Non-PAG based on drainage chemistry prediction data.

Geologic information can also be used to reassign samples if the geologic units are reclassified and to explain anomalous analytical test results. Geologic information, for drill core and blast hole cuttings, can usually be obtained from geologic logs.

The sample identifier should be written on the container and, if possible, on a label on the container. The identifier should be written in indelible ink and protected from being rubbed off.

### 8.7 Storage and Preparation of a Solid Sample

The objective in sample storage and preparation is to allow analysis or test work to be conducted on materials that contain the conditions and properties and processes required to predict or describe the drainage chemistry. The methods and conditions for sample storage and preparation should be a function of the properties of the:

- geologic material;
- waste material and project component;
- type of sample;
- sampling methods;
- storage facilities;
- targeted properties and processes; and
- analyses and test work to be performed.

The geochemical conditions of the material in the field should be maintained within samples

*The geochemical conditions of the material in the field should be maintained within samples where changes will obscure or destroy the targeted properties and processes of the subsequent analyses and test work. Nevertheless, some changes may be inevitable.*

where changes will obscure or destroy the targeted properties and processes of the subsequent analyses and test work. A good example of this is the need to maintain anaerobic conditions during sampling and

storage for samples from anaerobic sediments. Exposure to oxygen will change the composition of the pore water and the solubility of potential contaminants. Therefore, changes in geochemical conditions should be minimized where possible during storage. Nevertheless, some changes may be inevitable. Where differences occur they should be considered in the interpretation of the analyses and test work results.

After being collected, samples of drill core, blast hole cuttings and unweathered or aerated waste materials and walls should be air dried or oven dried at a low temperature. Prior to and after drying, the sample should be kept cool. Drying at temperatures no higher than 40°C will ensure most minerals are not altered. However, the evaporation of the pore water will cause solutes in pore water to precipitate. Typically, the effect of solute precipitation is minimal because the solute concentration is not significant compared to the concentration of previously precipitated weathering products.

Some sulphide oxidation may occur during drying and storage. Approaches that will minimize oxidation after sampling include freezing the sample, minimizing the delay prior to drying and avoiding humid storage conditions. Anaerobic conditions may be maintained by storing the sample under nitrogen gas.

Samples containing stones should be dry sieved into the >12 mm (stones), 2-12 mm (gravel), and < 2 mm size fractions. The weight of each fraction should be measured and recorded. Particles cemented together may be separated through some form of mechanical vibration, physical processing (e.g. rolling pin action) or a chemical pretreatment. It is important not to use a physical process which may promote autogenous grinding of particles. Chemical pretreatment should only be used if it is compatible with the subsequent sample analysis. The chemical pretreatment may also be used to measure elemental concentrations in the particle cement.

The decision of how much sample to crush and grind and to what particle size, should depend on the material needed for the proposed analyses and tests. Depending on the test requirements, a sub-sample of each particle size should be split off for crushing and grinding using an appropriate method such as a splitter box or

*The decision of how much sample to crush and grind and to what particle size, should depend on the material needed for the proposed analyses and tests.*

coning and quartering. Depending on the laboratory, crushing and grinding to < 74  $\mu\text{m}$  (200 mesh) or < 120  $\mu\text{m}$  (120 mesh) is usually recommended for sub-samples analysis of total elements, sulphur species, neutralization potential and other bulk, whole or total assays. Bedrock samples are often crushed to < 9.5 mm (3/8 inch) or 6.4 mm (1/4 inch) for static solubility water extractions, laboratory humidity cell and column kinetic tests.

Often crushing and grinding are conducted to an unspecified degree and the resulting particle size distribution will depend on the rock strength. Without any QA/QC, the resulting particle size is highly variable and has an unspecified particle size distribution. This is not an acceptable practice. The procedure for crushing and grinding and the resulting particle size should be specified and recorded for each test.

Since crushing and grinding creates new particles and surfaces, it should not be done on samples of particulate materials prior to sieving or on sieved particulate material prior to the measurement of surface properties such as pH or soluble constituents produced by surface weathering.

In sample preparation and sub-sampling prior to analysis, care should also be taken to collect samples that are large enough to limit “nugget effects” due to the non-uniform distribution of minerals in clusters. For example, if pyrite occurs as large porphyroblasts, the sample volume should be large enough to limit sub-sampling errors due to the random variation of the number of porphyroblasts in the sample.

## 8.8 Use of Samples Collected for Other Purposes

To improve the overall cost-effectiveness of the project, sampling and sample preparation for the prediction of drainage chemistry are sometimes combined with the sampling and sample preparation for other geochemical activities, such as the measurement of ore grades (e.g. blast hole cuttings) and metallurgical testing (Price, 2005). Aspects of sampling and sample

preparation for the prediction of drainage chemistry that may differ from the sampling and sample preparation for other geochemical activities are as follows:

- the importance of waste materials and mine walls;
- the need to characterize the geochemical variability at the thousand to ten thousand tonne scale;
- the importance of the particle size distribution, atmospheric and drainage conditions and the time of exposure;
- drainage chemistry largely depending on only a small portion of the total material, such as the < 2 mm size fraction of waste rock or of talus produced from mine walls;
- a need to predict over long time frames and widely ranging climatic conditions; and
- temporal changes in many of the properties and processes controlling drainage chemistry.

Thus, the use of samples collected for other purposes may lead to errors and omissions if the requirements for sampling and sample preparation for the prediction of drainage chemistry are not properly understood.

### **8.9 Particle Size and Exposed Surface Effects**

Factors that should be kept in mind during sampling, sample preparation and the interpretation of analysis and test results are:

- significant sulphide mineral weathering requires exposure to oxygen and moisture;
- a lack of physical exposure will greatly reduce or prevent chemical reactivity; and
- most laboratory protocols for sample preparation and analysis do not distinguish the exposed, previously or potentially weathered portion of a sample from the physically occluded portion that is unable to weather.

Ore is crushed and ground prior to processing to expose mineral surfaces. This enables reactions between the process water and mineral grains that would not be possible if the grains were still physically occluded. Crushing and grinding can have a similar effect on materials submitted for drainage chemistry analyses or test work.

Before crushing and grinding a sample, consider the effect on the properties of the sample and the subsequent analytical results and test work. Perhaps some other form of sample preparation would produce more accurate information about the measured properties and processes.

Other factors to consider regarding particle size and exposed surface effects when predicting mineral weatherability on excavated surfaces and excavated and process waste materials include the following.

- The smaller sized particles that contain the majority of the surface area exposed to weathering may have a significantly different composition from drill core or drill chip samples whose composition is representative of the material as a whole.
- The proportional magnitude of the fraction containing the majority of the surface area exposed to weathering should be considered when extrapolating laboratory results to the field.

One of the main parameters controlling particle and mineral surface area is particle size (Chapter 7). Surface area increases exponentially as particle size decreases (Brady, 1990). Consequently, most of the surface area and mineral exposure can occur in the sand, silt and clay sized particles. Relatively few of the mineral grains in coarse sized fragments occur on the exposed surfaces. Thus, competent coarse fragments and mine walls typically contribute relatively little to drainage chemistry because most of their mass remains physically occluded from oxygen and water. The smaller sized particles that contain the majority of the surface area exposed to weathering may have a significantly different composition from the material or the sample as a whole.

The proportional magnitude of the fraction containing most of the surface area should be considered when extrapolating laboratory results to the field. Surface area and reactivity may depend on properties other than particle size and may vary with time. When attempting to identify the reactive fraction of a particular waste or rock wall, one should also consider the porosity and the impact of excavation, deposition and weathering on future exposure to weathering and leaching.

Materials like tailings, consisting entirely of finely crushed and ground particles, have almost all their mineralogy exposed to weathering and the composition of the “whole” sample will determine the drainage chemistry and should be analyzed.

For coarser sulphidic geologic materials, where only a small proportion of the mineralogy is physically exposed to weathering, the composition of the “largely reactive” particle size will determine the drainage chemistry and should be analyzed separately from the “largely un-reactive” particle size. However, the particle size separating these two groups may not be readily apparent and can be arbitrary.

*For samples with a large range of particle size, the dividing line between the coarser “largely unreactive” and finer “largely reactive” particles may not be readily apparent and can be arbitrary.*

Ideally, the decision regarding the upper particle size cut-off for the “reactive” fraction should be a site specific evaluation that considers a number of features including the grain size of reactive minerals, the extent of previous weathering and the porosity of the coarse fragments. Based on observations of mineral reactivity made on waste rock with a wide range of grain size (Price and Kwong, 1997), the recommended rule of thumb is that the < 2 mm particle size be considered the reactive particle size fraction and that this particle size is separately analyzed in static tests and before and after kinetic test work. The validity of this generalization should be assessed for each site and material.

When sampling waste rock, talus from mine wall collapse and other stony geologic materials, it is most important to obtain representative samples of the < 2 mm size fraction in order to analyze the composition of the portion that will determine the drainage chemistry. Sampling and analysis of the proportion and composition of larger, less reactive particles will be needed to estimate the:

- contribution from the coarser particles that will be equivalent to a smaller amount of finer material, which may be used to scale up test results; and

- competency, particle breakdown, replenishment of reactive minerals and the future particle size distribution.

Ideally, samples should be collected of the entire particle size distribution, including boulders,

*Ideally, samples should be collected of the entire particle size distribution, including boulders, stones and other size fractions. Because of the difficulty in sampling boulders, the particle size cut-off is generally around 12 cm.*

stones and other size fractions. Because of the difficulty in sampling boulders, the particle size cut-off is generally around 12 cm. A recommended sampling strategy for waste rock and

other stony materials is to separate the >12 mm (stones), 2 to 12 mm (gravel) and < 2 mm fractions by dry sieving. Analysis of the stone and gravel sized fraction, in addition to the fine sized fraction of post-blast waste rock, is necessary to identify any geochemical differences between the fine particles and pre-mine or pre-blast whole-rock samples. Such differences may be due to minerals preferentially reporting to finer sized particles or to local geochemical variability that affects the fine and coarser sized particles differently.

Some challenges associated with the differential contribution of different particle sizes to drainage chemistry and separately analyzing the < 2 mm fraction include the following.

- Sieving could break weak particles or weathered particle surfaces, changing the particle size distribution and surface chemistry of the sample.
- Where the coarse fragments are a large portion of the mass, a very large sample will be required to provide a sufficiently large, < 2 mm fraction (e.g. 3 kg), to conduct all the desired analyses and tests.
- It will be difficult to conduct analyses of some properties of weathered surfaces on coarse fragments.

Other advantages with separately analyzing the < 2 mm size fraction are:

- it requires a small mass to provide a representative sample; and
- the smaller sample size requires smaller containers and apparatus.

Where pre-mining waste rock characterization is based on total sample analysis (e.g. drill core or drill chips), predictions and prediction criteria should be modified according to differences between the resulting composition of the fine fraction and the stone and gravel sized fraction.

The proportional contribution of coarse fragments may increase if coarse fragments break down rapidly, are porous, or the < 2 mm fraction is unreactive. The assumption that most contaminant releases come from the < 2 mm fraction may not be correct for historic mine wastes and naturally weathered materials in which weathering has removed reactive minerals from the finer particles.

*The assumption that most contaminant releases come from the < 2 mm fraction may not be correct for historic mine wastes and naturally weathered materials in which weathering has removed reactive minerals from the finer particles.*

An example of this was seen in talus samples at the Red Mountain site near Stewart, British Columbia, where the < 0.063 mm (230 mesh) often had the

lowest sulphide content. Depending on the degree of previous weathering, “reactive fraction” analyses should be carried out on a larger particle size distribution for strongly weathered materials (e.g. < 12 mm instead of < 2 mm).

When only a portion of the whole material is collected or analyzed, the proportional amount should be determined. For rock walls, this may require a visual assessment in the field. For a waste dump, the proportion of the fines containing material (versus fines free stones and boulders) should be estimated in the field. Laboratory sieve analysis of the “total” samples taken from the fines containing material should be used to quantify the proportional contribution of the analyzed size fraction.

For pre-excavation analysis done on bedrock samples of drill core, it is usually only possible to analyze the total sample. The composition of the reactive size fraction or surfaces may be approximated by crushing or estimated from petrographic analysis of the mineralogy of portions of the rock that are more and less friable.

### 8.10 Weathering and Leaching Features

Distinct weathering features, geochemical conditions and zones of leaching can be sampled to monitor or predict properties and processes that affect drainage chemistry. The location of areas with distinct weathering and leaching properties and processes can be identified by examining:

- exposed surfaces;
- surfaces exposed by digging holes; and
- materials removed by drilling.

Distinct weathering features, geochemical conditions or zones of leaching can be identified from differences in:

- field rinse or groundwater pH;
- reaction with hydrochloric acid;
- structure; and
- colour.

The pH of groundwater or perched water tables may be measured after extracting samples from standpipes or piezometers previously installed by drilling. Field rinse pH can be measured with a pH probe or pH paper to estimate the pore water or leachate pH from unsaturated material.

The reaction with dilute hydrochloric acid will indicate the presence of carbonate minerals. Calcite reacts (e.g. fizzes) strongly, dolomite reacts slowly and iron carbonate must be ground into a powder to react.

Structural changes due to weathering, geochemical conditions and leaching include the following.

- Particle migration may reduce the up gradient and increase the down gradient proportion of smaller particles.



- Particle breakdown may increase the proportion of smaller particles and voids and reduce the proportion of larger particles and voids.
- The precipitation of weathering products may coat and cement particles together, fill voids and create pans or cemented layers.

### 8.10.1 Colour

Colours can be described by comparing them with the colour chips in Munsell colour charts

*Colours can be described by comparing them with the colour chips in Munsell colour charts.*

*Use of the Munsell colour charts provides consistent, systematic criteria for evaluating, comparing and reporting colour differences.*

(Figure 8.2) and using the Munsell notations for hue (relation to red, yellow, green, blue and purple), value (lightness or darkness) and chroma (colour strength) in the Munsell colour charts. The five principal hues of red, yellow, green, blue and purple are split into a large number of intermediate hues.

Value varies from black (value 0) to white (value 10). Chroma is the strength or purity of the colour and a lower chroma is more washed out.

Use of the Munsell colour charts provides consistent, systematic criteria for evaluating, comparing and reporting colour differences. Colour value and chroma may decrease if the material is dry, so it is important to record whether the material is wet, moist or dry.

Colour changes may result from:

- dissolved chemical species;
- precipitated weathering products; and
- surface weathering of minerals.

The most common example of colour change is brown, red or yellow discolouration indicating the presence of ferric iron (Figures 3.8 and 8.3).

Colours are often not unique to the weathering of one mineral or an individual chemical species. Thus, care should be taken when using colour as an indicator of weathering features, geochemical conditions or zones of leaching. This includes:

- identifying all possible colour sources and mechanisms for the sources' occurrence; and
- conducting chemical and mineralogical analyses and test work to verify the identity of secondary minerals, amorphous precipitates and dissolved chemical species and their sources and mechanisms.

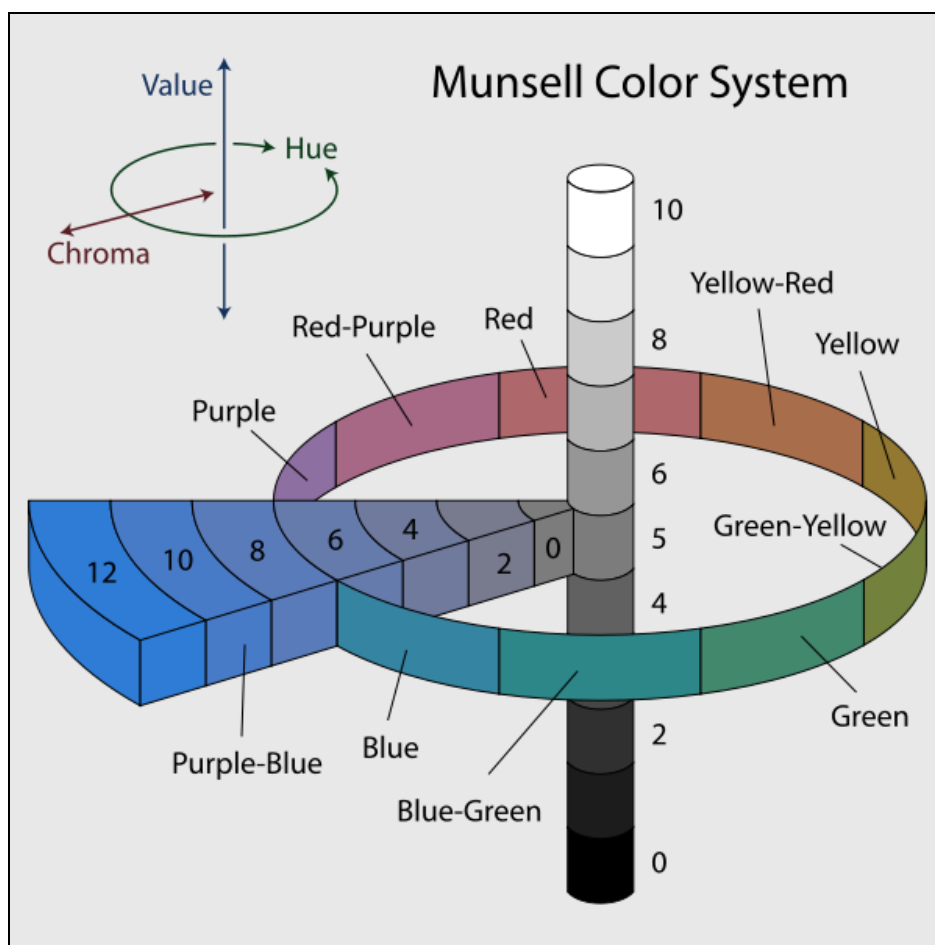
White precipitates include gypsum, aluminum hydroxide and carbonates. Coatings of carbonate can be identified by their reaction with hydrochloric acid. On the other hand, a drainage pH range of 4.0 to 4.3 or slightly higher suggests the white precipitate is a type of aluminum hydroxide (Chapter 5).

Precipitates produced from sulphide weathering products may have a wide range of colours.

*Precipitates produced from sulphide weathering products may have a wide range of colours.*

Distinct colours often seen at copper mine sites with near neutral pH drainage are the azure blue and bright green of azurite ( $\text{Cu}_3[\text{CO}_3]_2[\text{OH}]_2$ ) and malachite ( $\text{Cu}_2[\text{CO}_3](\text{OH})_2$ ), respectively.

There are usually a number of potential mineral sources and weathering and leaching mechanisms for observed colour changes. Under aerobic weathering conditions, iron may come from the dissolution of siderite and the hydrolysis of iron silicates, in addition to the oxidation of iron sulphide minerals. Under anaerobic conditions, iron may come from the dissolution of siderite or secondary minerals produced during previous periodic episodes of aerobic weathering.



**Figure 8.2** The Munsell colour system, showing: a circle of hues at value 5 chroma 6; the neutral values from 0 to 10; and the chromas of purple-blue (SPB) at value 5 (from Wikipedia).



**Figure 8.3** Different weathering and geochemical conditions or zones of leaching can sometimes be identified by colour changes.



**Figure 8.4** Colour may be indicative of more than one weathering condition.

It is important to keep in mind that dissolved and precipitated chemical species and phases may be due to upstream, past, seasonal or other periodic mineral weathering and leaching conditions and may not reflect in-situ or current conditions. For example, if the pH is near-neutral, iron released from primary mineral weathering will precipitate in-situ. Conversely, iron leaching may occur due to the solubility of ferrous iron under anaerobic conditions, or the solubility of ferric iron at a pH lower than 2.5 to 3.5. Also, dissolved iron produced upstream may precipitate on relatively unweathered minerals due to the oxidation of reduced drainage containing ferrous iron or the neutralization of acidic drainage containing ferric iron.

Brown, red or yellow discolouration may be absent despite high rates of iron sulphide oxidation as a result of high iron solubility due to a very low pH, coupled with rapid leaching due to high drainage inputs. There are two sites in British Columbia (Cinola and Kitsault) where portions of the waste rock look unoxidized based on their gray colour, when in fact there is a high rate of iron sulphide oxidation (Figure 8.4). Both sites have high precipitation and the specific waste rock contains 1 to 3% pyrite-S with little or no NP and a rinse pH well below 3. As a result, the iron released by oxidation remains soluble and is removed by leaching.

### 8.10.2 Natural Outcrops and Non-Lithified Surficial Materials

Weathered natural outcrops and non-lithified surficial materials may provide valuable information

*Weathered natural outcrops and non-lithified surficial materials may provide valuable information about how weathering will progress. However, the weathering properties and processes of older natural and newer project wastes and walls may differ.*

about how weathering will progress in mine wastes and walls under site specific weathering conditions. However, the weathering properties and processes of older natural and newer project wastes and walls may

differ. Therefore, when sampling weathered natural outcrops and non-lithified surficial materials, it is important to note:

- the stage of weathering;
- physical, atmospheric, drainage and geochemical properties and processes; and
- how these might differ when these materials or materials with a similar initial geochemical composition become waste materials and walls.

Differences in physical, atmospheric, drainage and geochemical properties and in the stage of weathering, may cause very different weathering rates and drainage chemistry in mined wastes and walls than natural sulphidic outcrops and non-lithified surficial materials. A much lower air permeability or exposed sulphide area may reduce the rate of sulphide oxidation sufficiently that drainage alkalinity or less reactive minerals are capable of neutralizing much or all of the acidity produced by sulphide oxidation. A lower pH or ratio of exposed sulphide to leaching in naturally weathered materials may result in lower contaminant concentrations. A much more advanced stage of weathering in natural outcrops and non-lithified surficial materials may mean that much of the exposed sulphide is depleted. This may result in very different weathering rates and drainage chemistry than fresh waste materials and walls.

Caution is required in extrapolating results from the limited portion of the geology and areas proposed for mining exposed in natural outcrops of rock or non-lithified surficial materials to the entire range of geologic materials and site conditions.

## 8.11 Pre-Development

### 8.11.1 Selection of Material to Sample

Prior to mine development, the choice of material to sample is often restricted to drill core. One advantage of drill core is that it often exists for most of the proposed area of mine excavations and for a large proportion of the rock types that will be excavated by a project. Another advantage is that the location, grade and visually detectable geologic conditions of the drill core have usually been logged and recorded as part of exploration, allowing a preliminary separation of the geologic materials into “operational” geologic units (rock types) and management units. Ideally, drill core is split, with half retained as a geologic record and the other half available for sampling.

*Prior to mine development, the choice of material to sample is often restricted to drill core.*

Other materials potentially available prior to mining to supplement information from exploration drill core are:

- weathered natural outcrops and non-lithified surficial materials;
- tailings created in the bench scale and pilot scale testing of the mill circuit; and
- the walls and waste rock extracted from exploration drifts and adits.

Although limited to only a few geologic units or areas proposed for mining:

- tailings from mill test work may indicate the effect of processing on proportional sulphide removal and on other geochemical characteristics of ore; and
- waste rock extracted from exploration drifts and adits may provide valuable information on the particle size distribution, mineral surface exposure and differences between the composition of the whole rock and the fine size fraction.

Older exploration drifts and adits or excavations from a previous mine may provide valuable evidence about where talus will form and the composition of talus fines versus that of the whole rock.

Caution is required in extrapolating results from the limited portion of the geology and areas proposed for mining in natural outcrops, non-lithified surficial materials, exploration adits, bulk samples and bench and pilot scale mill circuits to the entire range of geologic materials and site conditions. Care should also be taken to identify differences in physical, atmospheric, drainage and geochemical properties and processes and ensure they are properly considered in the interpretation and extrapolation of results.

### 8.11.2 Where, When and How Frequently to Sample

Prior to mining, samples should be collected at regular intervals across the width and depth of all geologic materials within proposed excavations and other areas of disturbance. The samples should include materials with significantly different physical (e.g. highly fractured),

mineralogical (e.g. mineral alteration), geochemical, weathering (e.g. oxidized) and leaching (e.g. supergene enrichment) properties.

A potential cause of errors and omissions in pre-mine prediction is a lack of drilling or other representative media to sample for some areas of the proposed excavation(s). Equipment limitations or a lack of resources may prevent drilling in deeper regions of the ore body below the depth required to demonstrate that the mine is economic. The focus on ore during exploration may result in a lack of drilling in less accessible waste material a long distance beyond the zone of economic mineralization. Increases in the proposed size of a pit or underground workings during feasibility studies may also increase the lateral extent of the waste rock beyond the area with drill core. Examples of difference in composition that may be of concern are the pyrite halos outside the ore but intercepted by pit perimeters at a number of copper and molybdenum mines.

Contingency plans and sampling of blast hole cuttings should be used to fill gaps in the width and depth of exploration drill core and in the understanding of the geologic, geochemical, physical, weathering and leaching properties of geologic materials, waste materials and walls prior to project development.

### 8.11.3 Dimensions to Sample

Prior to mining, the maximum length of drill core over which an individual sample is collected

*Prior to mining, the maximum length of drill core over which an individual sample is collected (or sub-samples are composited) should be bench heights for open pits or adit heights for underground workings.*

(or sub-samples are composited) should be bench heights for open pits or adit heights for underground workings. Where it is not possible to take a continuous sample over the desired length, sub-samples from

shorter lengths at regular intervals could be combined to create a representative sample (e.g. compositing five sub-samples collected at regular intervals).

A sampling unit, such as a bench height, should be split into separate samples when it contains different geologic units or material with different physical, mineralogical, geochemical, weathering and leaching properties, whose potentially different contribution to drainage chemistry needs to be individually understood. Drill logs and other geologic records should be consulted prior to sampling to identify areas of core with materials that need to be sampled separately.

### 8.12 Blast Hole Cuttings

Prior to blasting, geologically representative samples of bedrock destined to be waste rock,

*Prior to blasting, geologically representative samples of bedrock destined to be waste rock, construction material, ore, low grade ore and tailings can be obtained from blast hole cuttings.*

construction material, ore, low grade ore and tailings can be obtained from blast hole cuttings. An advantage of sampling blast hole cuttings is that their locations are recorded in a geologic block model for

the deposit.

A composite sample over the height of a pit bench or a cross section of an underground blast can be obtained by taking a cross section of the cuttings from a single pile of blast hole cuttings. The geologic properties of the cross section of the blast hole cuttings should be recorded during sampling and any differences in physical, mineralogical, geochemical, weathering and leaching properties should be noted in the sample description (Section 8.6).

The spacing at which blast holes are drilled will depend on various factors including the economics of mining, the friability and strength of the rock and the type of excavation. The spacing of blast holes in an open pit is usually sufficiently wide that samples from an individual blast hole could be analyzed separately in order to maintain the geologic and spatial integrity of the samples. The shorter distance between blast holes in an underground mining may sometimes allow compositing of samples from different blast holes in the same drift.

Not every blast hole needs to be analyzed. The frequency at which blast holes are sampled and analyzed will depend on the prediction objectives, the geochemical variability, the required accuracy and previous information.

Open pit, porphyry copper mines in Northern British Columbia typically blast 40 to 150 holes at a time to break 50,000 to 200,000 tonnes of rock. The amount of rock broken in each blast depends on the rate holes are drilled and loaded with explosive. The spacing of blast holes is in staggered rows, with a hole typically every 8 m by 8 m, but varying from 6 m x 6 m to 10 m x 10 m depending on the economics of mining and the friability and strength of the rock. The depth of blast holes is a bench height (~12 m) plus 1.5 m of sub grade (total of ~13.5 m).

At one mine where the purpose is to segregate potentially ARD generating from non-ARD generating rock, the frequency of sampling is every fifth blast hole or approximately one every 8,000 to 12,000 tonnes. Additional analyses and a review of the geologic variability were conducted to arrive at this sampling frequency. More frequent sampling is conducted when needed to more accurately identify the boundary between potentially ARD generating (PAG) and not-potentially ARD generating (non-PAG) rock. At another mine, the frequency of sampling is approximately one blast hole every 20,000 tonnes to segregate PAG from non-PAG. Where all the rock is either PAG or non-PAG and the purpose of sampling is documenting the elemental concentrations and Acid Base Accounting parameters, the sampling frequency is every 50,000 to 100,000 tonnes.

To avoid losing ore and milling waste rock, blasting typically results in very little lateral mixing of the material and displacement of boundaries created from the blast hole data. Occasionally the presence of visible differences makes it possible to remove the rock almost exactly to the boundary. The minimum amount of material that can be segregated is one loader bucket width.

*Typically, blasting results in little displacement of the material and boundaries created from the blast holes. This improves the opportunity for material segregation based on pre-blast information.*

The time between blasting and waste rock movement is dependent on the mining schedule but it is usually within a few weeks, which allows some oxidation and weathering to start in the rock before transport. It can be uneconomic to blast too far ahead of shovel production as this may

result in costs being incurred well ahead of sales or reduced commodity recovery if there is marked weathering of the ore.

### 8.13 Excavations

Geologic materials remaining or placed in excavations that should be sampled include (Chapter 7):

- residual blasted material;
- backfill;
- final walls; and
- notable areas or masses of talus, fractures and residual blasted rock.

Although final wall surfaces are likely to be a relatively small portion of the future weathered surface area, they may need to be sampled to:

- predict the future composition of talus; and
- identify sources for existing drainage chemistry.

Residual blasted rock, backfill and/or talus produced by roof and wall collapse will be the largest source of weathering products in mine workings. The amount of talus will be relatively small and probably will not need to be sampled in regions of the excavations where the voids are almost entirely backfilled.

#### 8.13.1 Sampling Backfill and Residual Blasted Rock

Sampling backfill should follow the procedures for the different types of backfill material (e.g. waste rock, different tailings products and other backfill sources), with modifications for any differences in materials handling, reprocessing, amendments or segregation. Backfill sampling should occur prior to or during backfill placement as it is difficult to sample backfill after it is in place. Use other sampling programs for drainage chemistry prediction only if they provide samples of the final backfill material. Waste rock used as backfill underground can be sampled on the post-blast muck pile from which it originates. Backfilled tailings should be sampled after final processing and any amendments (Price, 2005).

Sampling residual blasted rock should follow the procedures for sampling waste rock. Sampling of residual blasted rock should occur as soon as possible after blasting.

Where future access is a concern, it may be advisable to remove large enough representative samples of backfill, residual blasted rock and/or talus to construct field trials in a more accessible area.



### 8.13.2 Operational Sampling of Final Walls and Resulting Fractures and Talus

Operational sampling of final mine walls typically consists of rock chips collected over an area of wall with relatively uniform geologic, physical, mineralogical, geochemical, weathering and leaching properties. Separate rock chip samples can be collected from fracture surfaces to determine if their composition differs from that of the wall as a whole.

*Separate rock chip samples can be collected from fracture surfaces to determine if their composition differs from that of the wall as a whole.*

Sampling of notable areas or masses of talus, fractures and residual blasted rock should follow the procedures for waste rock.

Sampling of final wall surfaces and the resulting fractures and talus should occur before access is cut-off or the area becomes unsafe. Final mine walls may be unstable and sampling should only be conducted when it is safe to do so.

The sample dimensions and sampling frequency and locations will depend on the prediction objectives, mining practices, geochemical variability, the required accuracy, previous information and the potential contribution of the sampled material to the drainage chemistry. One commonly used sampling protocol is to combine sub-samples collected along short transects. For example, each analyzed sample may be a composite of sub-samples collected every meter along 4 to 5 m transects.

### 8.13.3 Sampling after Construction of the Excavations

Sampling of weathering and leaching features and drainage inputs and outputs from backfill, residual blasted rock and talus should, to the extent required and practically possible, follow the procedures used for other waste materials of similar physical composition, with modifications for any differences in materials handling, reprocessing, amendments or segregation.

## 8.14 Post-Blast Waste Rock

Sampling of post-blast waste rock occurs from:

- excavation faces or the disposal location prior to incorporation in the dump; or
- holes and trenches in dump surfaces or holes drilled in the dump.

Their large size and weight make it very difficult to collect samples and measure the mass of the largest waste rock particles from underground mines and practically impossible for the boulder sized coarse fragments of waste rock from open pits. The coarse fragments in blasted waste rock from an open pit can be up to 3 m in diameter.

Due to the logistical problems of handling large, heavy particles:

- samples of post-blast waste rock are typically restricted to particles  $< \sim 12$  cm in diameter; and
- the stone sized fraction ( $\sim 12$  cm to 12 mm) or the stone and gravel sized fraction ( $\sim 12$  cm to 2 mm) is considered to be representative of the entire coarse sized fraction.

Samples of post-blast waste rock should be sieved into fine and coarse particle size fractions prior to analysis. The diameter of the fine sized fraction that contains almost all the particle surface area will be material specific. Many mines use < 2 mm as the sieve size for the fine fraction and this is the particle size used to segregate soil from gravel in soil science. Less than 2 mm is a particle size in which typically most of the mineral grains will be exposed.

#### 8.14.1 Sampling during Excavation

Post-blast waste rock sampled during excavation and mining may be used as:

- the primary source of information on the composition of waste rock; or
- a check on procedures for classifying and segregating waste rock based on the sampling and analysis of exploration drill core or blast hole cutting.

Ideally, waste rock should be sampled at the blast site so the data can be compared with previous data from drill core or blast hole chips from the same location. An alternative is to collect samples when truck loads are first dumped at the disposal site.

Once waste rock is incorporated into a dump, it would be difficult to sample material that corresponds to specific drill or blast holes samples and compare the two sets of results because:

- deposition may occur at a number of locations;
- waste rock spreads out and mixes with other waste rock to some degree; and
- there is usually no systematic record of all the locations where the waste rock from each blast is deposited.

Concerns with sampling active excavations and disposal areas include:

- safety issues with sampling in areas with active equipment and unstable waste rock faces;
- sampling may interfere with mining, causing delays; and
- analysis results come too late to influence material handling.

One way to avoid working around active equipment is to conduct sampling during coffee and lunch breaks or shift changes. Although

*One way to avoid working around active equipment is to conduct sampling during coffee and lunch breaks or shift changes.*

sample results will come too late to influence deposition of the sampled material, information on the particle size distribution and geochemical composition of the stone,

gravel and finer sized particles may be used to refine handling criteria for subsequent waste rock.

The sampling frequency should be guided by the prediction objectives, the geochemical variability, the required accuracy, the previous information and logistical constraints such as how much rock is moved between coffee break and lunch. Sampling should:

- be relatively frequent when a new geologic unit is first mined and there is little previous information about whether the geochemical composition of the stone, gravel and finer sized particles differ; and
- decrease as the uncertainty about the differences between the geochemical composition of the stone, gravel and finer sized particles is reduced.

A strategy used for sampling post-blast waste rock at some British Columbia mines is that each sample is a composite of the sub-samples (five) collected at meter intervals along a four meter transect at the base of the excavation face.

#### 8.14.2 Sampling after Dump Construction

The objectives of sampling after dump construction are to:

- determine the composition of waste rock where there was inadequate previous characterization; and
- monitor changes in weathering and leaching rates and conditions and the resulting drainage chemistry.

Sampling after disposal may be needed to determine the composite dump composition where waste rock is co-disposed with other materials (e.g. waste rock and tailings co-disposed in backfill) or where thin layers of waste rock are mixed with the underlying soil material (e.g. thin layers of crushed waste rock used to surface roads or airstrips).

Samples can be collected by digging holes and trenches or by drilling. Sampling waste rock

*Drilling usually cannot provide reliable samples for analyses like in-situ particle size and particle surface weathering. However, drilling does provide access to greater depths for monitoring of drainage, gases, and temperature.*

from faces exposed by digging holes and trenches is required if the objective is to measure the particle size distribution, the composition

of the fine size fraction, the solubility of weathering products, or other changes due to weathering and the resulting pore water chemistry. Samples obtained by drilling cannot usually provide this information because drilling breaks particles, creating new fine sized particles and exposing fresh unweathered minerals. However, one advantage of drilling is that the holes can subsequently be used for monitoring oxygen and temperature at different depths and to determine the height of the water table.

Representative samples of sulphidic geologic material placed in a single, thin waste rock bench will be accessible from shallow trenches or pits. Representative samples of the entire range in the composition of waste rock will be far more difficult to collect from trenches or pits where dumps consist of more than one lift or where the drainage chemistry is determined by properties and processes in the middle or at the bottom of a high dump. Information on changes in particle size and weathering and leaching conditions can be obtained by ongoing sampling and analysis of waste rock in dumps or field test pads.

Prior to sampling, the location or distribution of geologic materials and areas with significantly different physical, mineralogical, geochemical, weathering and leaching properties, should be identified by:

- reviewing records and maps of waste rock excavation and dump construction; and
- mapping the surface.

If possible, mapping should be done along the faces of backhoe trenches excavated across the length and width of the surface of the waste rock. Backhoe trenches will expose structure,

geologic composition and weathering features and vertical variability that may not be evident at the surface, especially if there is a compacted traffic layer. Where the objective is to monitor changes in weathering then spatial differences in secondary mineral precipitation and other weathering properties should be mapped.

Samples should be collected at regular intervals across the width and depth of the different geologic units and areas with other significantly different properties. The dimensions to sample will depend on the variability of the properties of interest. Compositing should be avoided for materials that have a significantly different geologic composition, structure and weathering and leaching conditions. Where differences in potentially important properties occur irregularly or along continuums, samples should be taken from geochemically similar units.

## **8.15 Tailings and Other Processing and Treatment Wastes**

### **8.15.1 Sampling during Processing, Treatment and Deposition of the Resulting Wastes**

Process water, different tailings products and other products of processing and treatment (Chapter 7) should be sampled during active processing and treatment to permit analysis of their physical and geochemical composition. Depending on the complexity of the process, there may be more than one processing or treatment waste. Examples of the different types of tailings products that may need to be sampled are as follows:

- tailings produced from different ore types with different geochemistry;
- slurry, thickened and filtered tailings;
- tailings sands and slimes;
- sulphide rich tailings fractions, such as sulphide-rich cleaner tailings fraction and the sulphide by-product of tailings desulphurization;
- cycloned tailings sand;
- backfilled mill tailings amended with other materials, such as cement or crushed waste rock or borrow materials;
- desulphurized tailings;
- tailings spills; and
- tailings moved by water and wind erosion.

Where, when and how often to sample will depend on the:

- existing information;
- where and when representative material is available;
- timing of management actions and regulatory decisions;
- variability of the targeted properties and processes; and
- accuracy and precision required of the prediction.

An important consideration with regards to sampling representative material is that tailings and process water should be sampled after:

- reprocessing (e.g. cycloning or desulphurization);

- addition of supplementary materials (e.g. cement or borrow materials);
- mixing of different waste streams (e.g. rougher and cleaner tailings); or
- segregation during transportation and deposition (e.g. tailings sands and slimes).

Tailings leaving the mill will not be representative of the composition of final tailings where other materials or amendments are added (Price, 2005) to reduce disposal costs (e.g. treatment wastes or sewage) or increase their volume (e.g. crushed waste rock or borrow materials) and strength (e.g. cement or fly ash).

*To ensure representative samples, tailings and process water should be sampled after any reprocessing, addition of supplementary materials or segregation.*

Tailings sand and slimes produced by alluvial particle and mineral segregation during deposition on a tailings beach may have different compositions than the whole tailings. Regular sampling of the tailings slimes and sands may be difficult due to ponding and a lack of strength during active deposition. Possible options during active processing include sampling during intermittent periods of drying or when the tailings are frozen. Options where field sampling is impractical include particle size separation and artificially simulating the post-disposal segregation of the sand and slime fractions. Artificially simulating differential settling or particle size separation may be used to predict the composition of the sand and slime fractions prior to mining.

Air entry and the rates of weathering and leaching in tailings are typically highest in the upper, surface layer of tailings. Therefore, it will be important to sample the final, upper layer of tailings in impoundments and other areas of tailings disposal.

During active deposition, saturation and neutralization by process water will limit oxidation in impoundments and other areas of tailings disposal. Sampling of weathering features in impoundments and other areas of tailings disposal will not be required until final surfaces are completed or if there is a prolonged interruption in tailings disposal at one location in the impoundment. Sampling may however need to provide representative test materials for laboratory and field weathering (kinetic) studies soon after the start up of tailings disposal.

*Saturation and neutralization by process water will limit oxidation during tailings disposal.*

When processing starts, there is often relatively little information on tailings composition and frequent sampling is required. Frequent sampling may also be required:

- where a tailings product is used for construction in a sensitive area and prolonged upsets are not permissible; or
- whenever significant modifications occur in the ore, mill, reprocessing, supplementary materials or segregation, to confirm there is a consistently acceptable composition before tailings are permitted to be placed in sensitive areas.

### 8.15.2 Sampling after Closure of Processing Facilities

The objectives of sampling tailings after closure of processing facilities may be to:

- characterize the surface in more detail;

- determine the composition of tailings where there was inadequate previous characterization; and
- monitor changes in weathering and leaching rates and conditions and the resulting drainage chemistry.

The low bearing strength may result in inadequate characterization of the tailings sands and slimes until deposition stops and the tailings surface dries.

Samples can be collected by digging holes and trenches or by drilling. Depending on the depth and strength of tailings and the height of the water table, representative samples of deeper tailings may not be accessible by digging pits. Unlike waste rock, drilling can be used to collect intact samples of tailings that can be used to measure the particle size distribution, the composition of the fine size fraction, the solubility of weathering products and the resulting pore water chemistry. One advantage of drilling is that the holes can subsequently be used for monitoring oxygen and temperature at different depths and to determine the height of the water table.

Prior to sampling impoundments and other areas of tailings disposal, the probable distribution of tailings materials with significantly different geologic, physical, mineralogical, geochemical, weathering and leaching properties should be identified by reviewing records and maps of tailings deposition and mapping the surface. If possible, mapping should also be done along the faces of backhoe trenches excavated across the length and width of the surface. Backhoe trenches will expose vertical variability in structure, geologic composition and weathering features that may not be evident at the surface, especially if there is a cemented hard pan layer. Where the objective is to monitor changes in weathering, spatial differences in secondary mineral precipitation and other weathering properties should be mapped.

Samples should be collected at regular intervals across the width and depth of the different geologic units and areas with other significantly different properties. The dimensions to sample will depend on the variability of the tailings properties of interest. Compositing should be avoided for materials that have a significantly different geologic composition, structure and weathering and leaching conditions. Where differences in potentially important properties occur irregularly or along continuums, samples should be taken from geochemically functional areas and depths.

### 8.16 Safety

Safety should be a major consideration during sampling. Concerns include:

- steep and unstable ground conditions, especially in excavations;
- air quality in underground workings and in depressions and confined areas when sampling excavations, waste rock and tailings;
- danger to eyes from rock chips during drilling;
- mining activities such as blasting and equipment working nearby; and
- remoteness of many sites especially when they close.

Plans for sampling and sample preparation should include measures, equipment and proper training of personnel to address potential concerns.

*Be safe when sampling!*

## 8.17 References

Australian Government Department of Industry, Tourism and Resources. 2007. Managing Acid and Metalliferous Drainage Handbook. p. 108.

Brady, N.C. 1990. The Nature and Properties of Soils. 10th Edition. Macmillan Publishing Company. p. 622.

British Columbia Acid Mine Drainage Task Force (BCAMDTF). 1989. Draft Acid Rock Drainage Technical Guide, Volume 1. August 1989.

Price, W.A. 2005. Case Studies of ML/ARD Assessment and Mitigation: Snip Gold Mine. MEND Report 9.1c.

Price, W.A. and Y.T.J Kwong. 1997. Guidelines for the Prediction of Acid Rock Drainage and Metal Leaching for Mines in British Columbia. Part III. Waste Rock Weathering, Sampling and Analysis: Observations from the British Columbia Ministry of Employment and Investment Database. In: Proceedings of the Fourth International Conference on Acid Rock Drainage, Vancouver, British Columbia, May 31 - June 6, 1997. Vol 1: 31-45.





## 9.0 OVERVIEW OF STATIC AND KINETIC TESTS

### *Some Important Points in this Chapter*

*The analyses and tests for predicting drainage chemistry can be divided into one time “static” and repetitive “kinetic” tests. There are many types of static tests, such as Acid Base Accounting (ABA) and total elemental analyses; these can be completed relatively fast. Kinetic tests, including laboratory based humidity cells and on-site leach pads, can take years to complete and are more expensive. For these reasons, kinetic testing is often limited to samples identified as important and representative by static tests. Also, some kinetic tests provide primary mineral reaction rates, while others provide direct predictions of drainage chemistry after additional processes.*

*Therefore, the objectives of all testing should be carefully considered and stated. Flow rates should always be measured in all kinetic tests to assist in interpretations.*

*Many static and kinetic tests provide some information that is similar and complementary to others, so any discrepancies should be investigated and resolved. Test results should be carefully tabulated, accompanied by descriptive statistics, and also shown on scatterplots.*

### 9.1 Introduction

Drainage chemistry prediction should be based on evidence from a number of different sampled materials (Chapter 8), analyses and tests (e.g. Figure 4.1). Well-informed, site specific decision making requires comprehensive testing and is only possible if the necessary information is obtained and correctly interpreted. Analyses and tests used to predict drainage chemistry can be separated into static tests and kinetic tests. In drainage chemistry prediction, the term “static” test refers to analyses that measure the composition or quantity of some constituents in a sample at a single point in time. Kinetic tests consist of one or more measurements of samples taken over time from a material exposed to certain weathering and leaching conditions.

*Analyses and tests for predicting drainage chemistry can be divided into one-time “static” tests and repetitive “kinetic” tests.*

The analyses and tests selected for each project component should be based on the prediction objectives and on the physical, drainage, atmospheric and geochemical conditions that control weathering and leaching. Some analyses and tests have specific requirements and it is important to follow the proper procedure (e.g. measurements of Neutralization Potential, or NP). Other analytical procedures and tests should be modified to match site conditions such as the drainage pH or the relative amounts of sulphidic material and leachate (e.g. analysis of soluble constituents, see Chapter 11).

Slight differences in analytical or test procedures for the same property may give different results. In some cases, standard calculations are used to convert the measurements into common units of interest (e.g. % sulphide-S is multiplied by 31.25 for conversion to acid potential in units

of kg CaCO<sub>3</sub> equivalent/tonne). It is important to know the procedure details and units when interpreting or reviewing the results.

## 9.2 Static Tests

Static tests measure chemical, physical and mineralogical properties of a sample. There are a

*There are a large number of chemical, physical and mineral properties that potentially influence drainage chemistry and consequently, a large number of potential static test procedures.*

large number of chemical, physical and mineral properties that potentially influence drainage chemistry and consequently, a large number of potential static test procedures. As with all aspects

of drainage chemistry prediction, the prediction questions and the weathering and leaching conditions must be considered in the selection of static tests and the interpretation of their results.

Static tests play a large number of roles and form much of the basis for the prediction of drainage chemistry. For example, static tests are used to measure the composition of geological materials, wastes (e.g. rock, tailings overburden), openpit and underground walls and weathering features. Also, detailed static test data can be used to set criteria for material classification at a site. Operational static tests may be used to segregate materials for separate disposal and mitigation. Static test data can be useful in identifying materials with little or no ARD potential and trace elements of lesser concern. However, given the present limited knowledge regarding rock and mineral reactivity and the limits of precision and accuracy in the tests, static test criteria may be rough and conservative at a site.

The results from a static test are generally used in conjunction with data from other static and kinetic tests (discussed in detail in many of the following chapters), modeling drainage chemistry (Chapter 20) and information about future physical, drainage, atmospheric and geochemical conditions (Chapters 6 and 7). For example, if waste rock is submerged after mining, the concentrations of soluble chemical species and the rinse pH of waste rock may be used with the volume and chemistry of flood water and the solubility modeling to predict trace element concentrations in the water cover.

Static test information obtained prior to kinetic tests can be used to select kinetic test materials and to predict the approximate time until critical changes occur. For example, static measurements of the acid and neutralizing potential and the solid phase levels of potentially acid generating and neutralizing minerals may be used with kinetic humidity cell reaction rates to predict approximate times to the onset of acidic drainage under aerobic weathering conditions.

Chemical elements or properties determined by some static tests may occur in more than one mineral or chemical compound within a sample (see Chapter 8). In some cases, minerals or chemical compounds that play no role in the field may contribute to the static test results. Thus, discrepancies between the contribution of different minerals or chemical compounds in the field and in the test may occur when static tests attempt to replicate the cumulative effect of much slower kinetic processes (e.g. neutralization potential). Consequently, static tests can underestimate or overestimate the target parameters compared to site conditions and the correct interpretation of static test results is critical to the prediction of drainage chemistry.

One way to improve the accuracy of the resulting prediction is by conducting similar, complementary tests. Significantly different results from analyses measuring similar properties (e.g. carbonate-NP and bulk-NP) may indicate that there are sample components that result in “blind spots” in one or both the analyses (e.g. significant contribution of Fe or Mn carbonate to the measured NP). Somewhat redundant information may provide critical cross checks or aid in the interpretation of predictive information, with discrepancies pointing to properties or conditions warranting further examination and clarification. Complementary tests can also be used to check for analytical errors and select the most cost-effective means of operational sample characterization.

*One way to improve the accuracy of the resulting prediction is by conducting similar, complementary tests. Significantly different results from analyses measuring similar properties may indicate that there are sample components that result in “blind spots” in one or both the analyses.*

The tests listed below measure parameters that may strongly influence drainage chemistry and should be considered for inclusion in any prediction program.

- a) Total Elemental Analysis (Chapter 10):
  - Whole-rock major element analyses such as by XRF; and
  - Multi-element trace analysis by ICP after strong acid digestion (major, minor and trace constituents).
- b) Soluble Constituents (Chapter 11):
  - Selective dissolution analyses including:
    - surface rinse and crushed pH measurements; and
    - shake flask (water extraction) measurements of accumulated reaction products.
- c) Sulphur species, including sulphide, leachable sulphate and total sulphur (Chapter 12).
- d) Neutralization potential (Chapter 13):
  - Bulk Neutralization Potential;
  - Sobek neutralization potential;
  - Modified Lawrence neutralization potential; and
  - Carbonate based neutralization potential, including detection of iron and manganese carbonates (although manganese carbonates are less common).
- e) Acid Base Accounting (Chapter 14):
  - Neutralization Potential Ratio; and
  - Net Neutralization Potential.
- f) NAG test (Chapter 15).
- g) Physical Analyses (Chapter 16):
  - Particle size analyses; and
  - Surface Area.
- h) Mineralogical determinations/examinations (Chapter 17):
  - Visual description;
  - Petrographic analysis;
  - X-ray Diffraction;
  - SEM/EDS;
  - Microprobe; and
  - Laser Ablation.

The recommended procedures for whole-rock and multi-element analyses, solubility and other selective extraction analyses, particle size analysis, and mineralogical examinations are commonly used in geology and soil science.

The combined measurement of sulphur species, neutralization potential and paste (crushed) pH accompanied by the calculation of net neutralization potentials and net potential ratios is called Acid Base Accounting (ABA, Chapter 14). There are several variations of ABA. The initial procedures were described by Sobek et al., (1978), also known as the EPA-600 methods. Modifications to these procedures have been developed and are described here.

The evaluation of static test data requires data tabulation, calculation of descriptive statistics and plotting of critical parameters. The calculated descriptive statistics should include means and 10%, 50% (median) and 90% percentiles (Table 9.1). Tabulation and derivation of descriptive statistics should be done for each potentially unique geological unit and waste or exposure type.

*The evaluation of static test data requires data tabulation, calculation of descriptive statistics and plotting of critical parameters.*

**Table 9.1 Minimum recommended descriptive statistics for static tests.**

Percentiles	10%, 50% (median), 90%
Central tendency moments	arithmetic mean, arithmetic standard deviation <sup>1</sup>
<sup>1</sup> if the distribution is not normal or log normal, other statistics should be used	

Arithmetic means and standard deviations are based on the assumption that data are distributed normally. This is not always the case. Therefore, the distribution of data from static tests should be displayed graphically. Based on the observed distribution, appropriate statistical summaries can be created and if desired, percentages of statistical populations within specified categories (e.g.  $NPR < 1$ ) can be estimated.

In addition to the tabulation of descriptive statistics, data evaluation requires the production of scatterplots which graphically reveal aspects of the distribution of data and population differences not always apparent in the statistical data. Also, scatterplots of one parameter against another can illustrate the relationships, such as correlations, between key parameters. For example, a scatterplot of surface rinse pH vs. NP may reveal the amount of unavailable NP in weathered samples after the sample becomes acidic (“goes acid”), and a plot of iron vs. sulphide may indicate the additional amount of iron not accounted for by iron sulphide minerals. Mineralogical examinations (Chapter 17) will also assist in these interpretations.

The required plots will depend on the site and the prediction questions (Chapters 12, 13 and 14). However, there are some scatterplots that are often helpful to interpretations and usually should be produced (Table 9.2 and Figures 9.1 to 9.5).

**Table 9.2 Generically required scatterplots for Acid Base Accounting.**

Parameter #1	vs. Parameter #2	Potential Purpose
< 2 mm Surface Rinse pH	Paste pH	comparison of pH methods; differences between surficial and bulk pH
Total Sulphur	Sulphide	portion of total sulphur comprised of sulphide; implications of substituting total sulphur for sulphide
	Sulphate (optional)	portion of total sulphur comprised of sulphate; relationship of sulphate to total sulphur
Sulphide	Sulphate	oxidative relationship of sulphide to sulphate
	pH <sup>1</sup>	correlation showing any control by sulphide (for weathered materials only)
Sobek NP (CO <sub>3</sub> -NP) <sup>2</sup>	CO <sub>3</sub> -NP	portion of NP comprised of carbonate minerals; general reactivity of carbonate minerals
	pH <sup>1</sup>	correlation showing any control by NP; estimation of unavailable NP (for weathered materials only)
	NPR	unavailable NP in samples with high NPR
	Sulphide	balance between AP and NP
	Particle Size	for weathered samples shows the contribution of various particle sizes and possible occlusion
NPR	NNP	relationship of two calculated bulk balance parameters; substitution of one parameter for another
	pH <sup>1</sup>	preliminary adherence to critical NPR values based on pH (for weathered materials only)

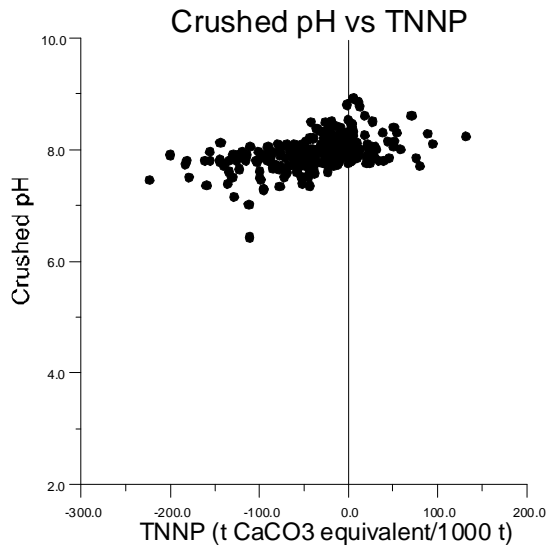
<sup>1</sup> The use of both < 2 mm surface rinse pH and paste pH should be reviewed.

<sup>2</sup> The use of both Sobek NP or CO<sub>3</sub>-NP should be reviewed; see also Figure 9.1.

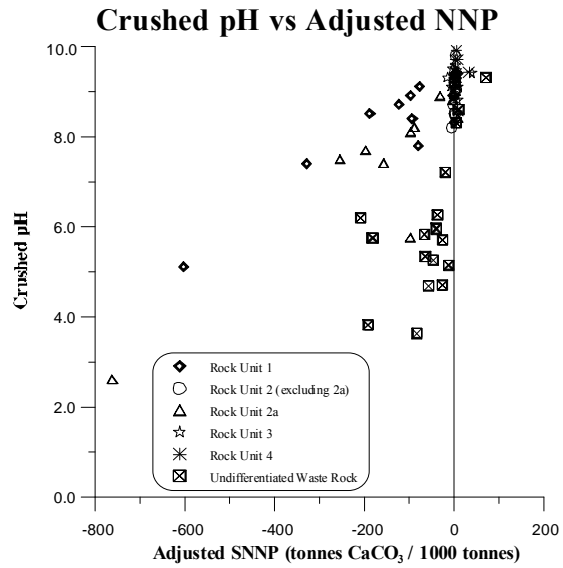
Tabulated raw data, scatterplots and descriptive statistics should be examined to:

- determine which, if any, trace elements occur in anomalous amounts;
- determine which analyses and correction factors are required to accurately and cost-effectively measure the AP and NP;
- compare descriptive statistics with criteria for potentially acid rock drainage generating (PAG) material to provide an initial assessment of the ARD potential for 10%, median, and 90% of the samples in each geological and management unit; and
- identify anomalous samples or groups of samples whose performance may significantly differ from or alter the performance of each geological and management unit and determine whether these materials can be handled separately.

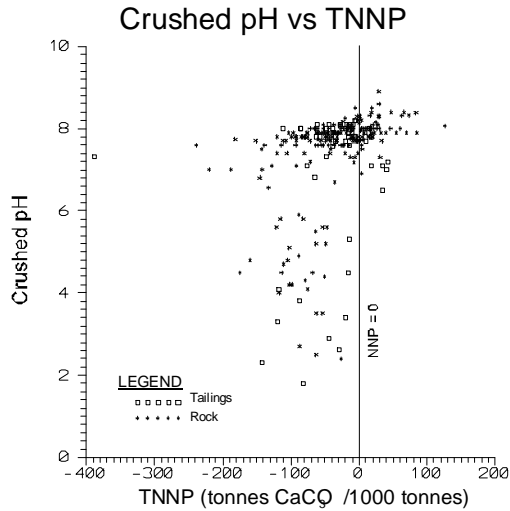
The location, geological unit, waste type, sample location and sample type are needed. Where possible, data from sample groups whose spatial occurrence, project component and composition suggest they can be treated alike should be combined.



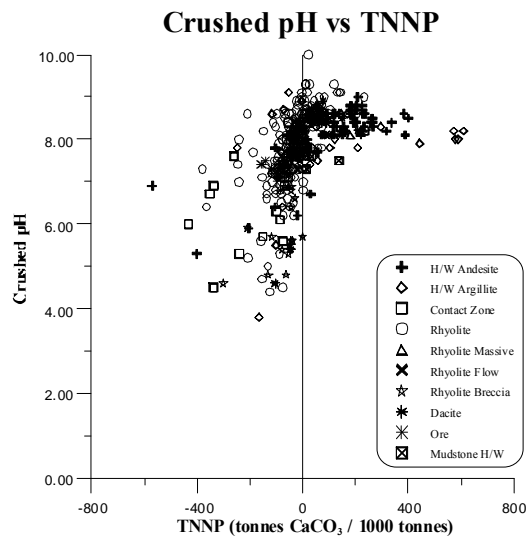
a) early stage of acid generation; no acidic samples



b) some samples with NNP < 0 acidic; some still neutral to alkaline

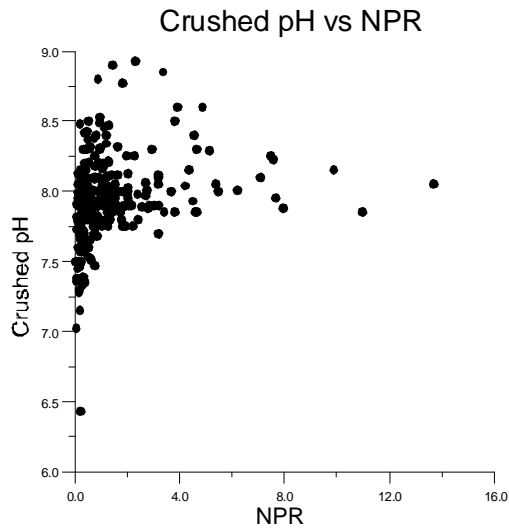


c) some samples with NNP < 0 acidic; some still neutral to alkaline

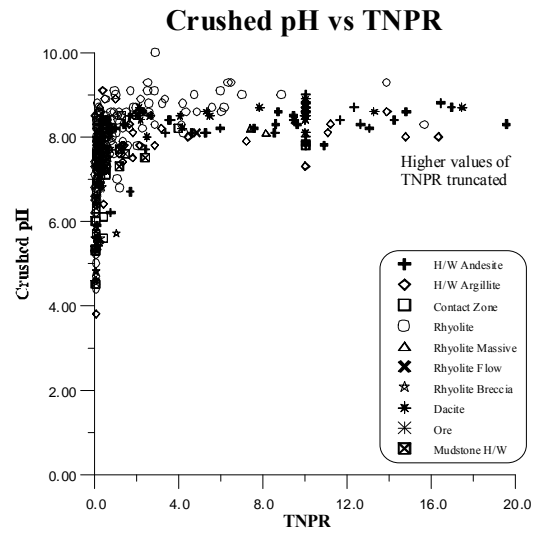


d) some samples with NNP < 0 acidic; some still neutral to alkaline

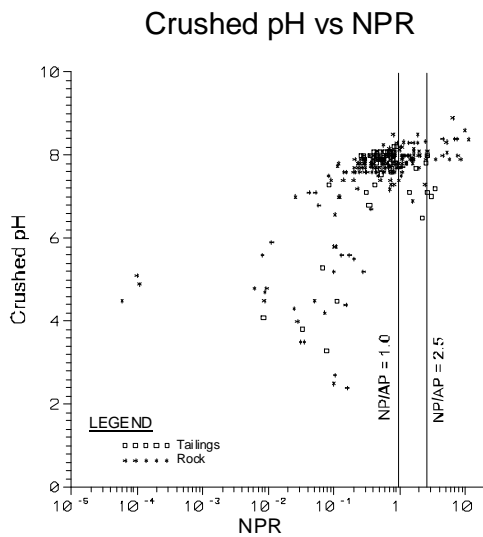
Figure 9.1 Scatterplots of xNNP vs. crushed pH from B.C. mines.



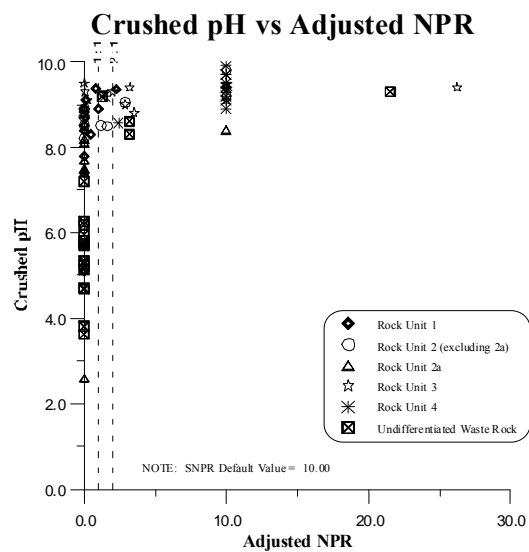
a) early stage of acid generation; no acidic samples



b) intermediate stage of acid generation; only a few samples with TNPR < 1.0 associated with acidic pH



c) only samples with NPR < 0.3 have acidic crushed pH



d) adjusted NPR values ~ 0 (unavailable NP subtracted) associated with acidic and neutral/alkaline pH

Figure 9.2 Scatterplots of xNPR vs. crushed pH from B.C. mines.

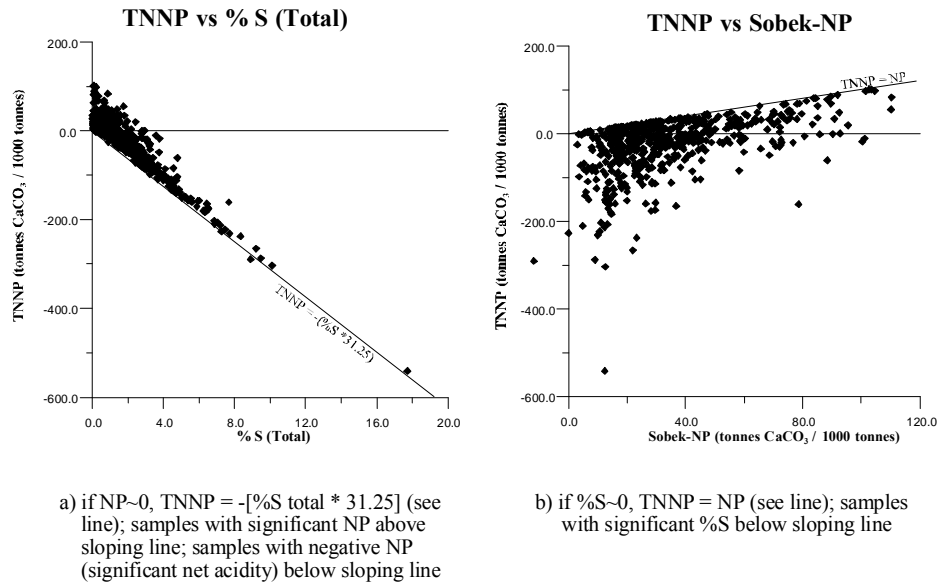


Figure 9.3 Scatterplots of xNNP vs. total sulphur and Sobek NP from B.C. mines.

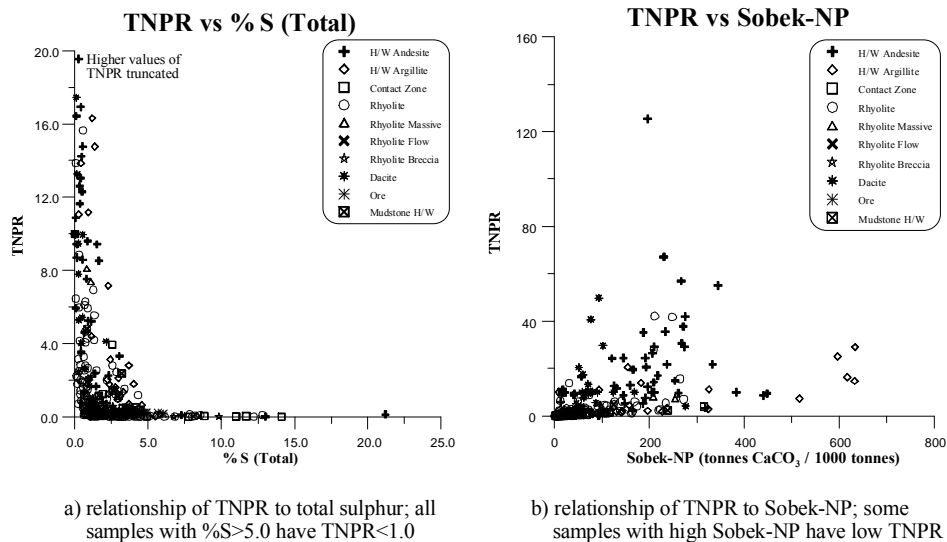


Figure 9.4 Scatterplots of xNPR vs. total sulphur and Sobek NP from B.C. mines.



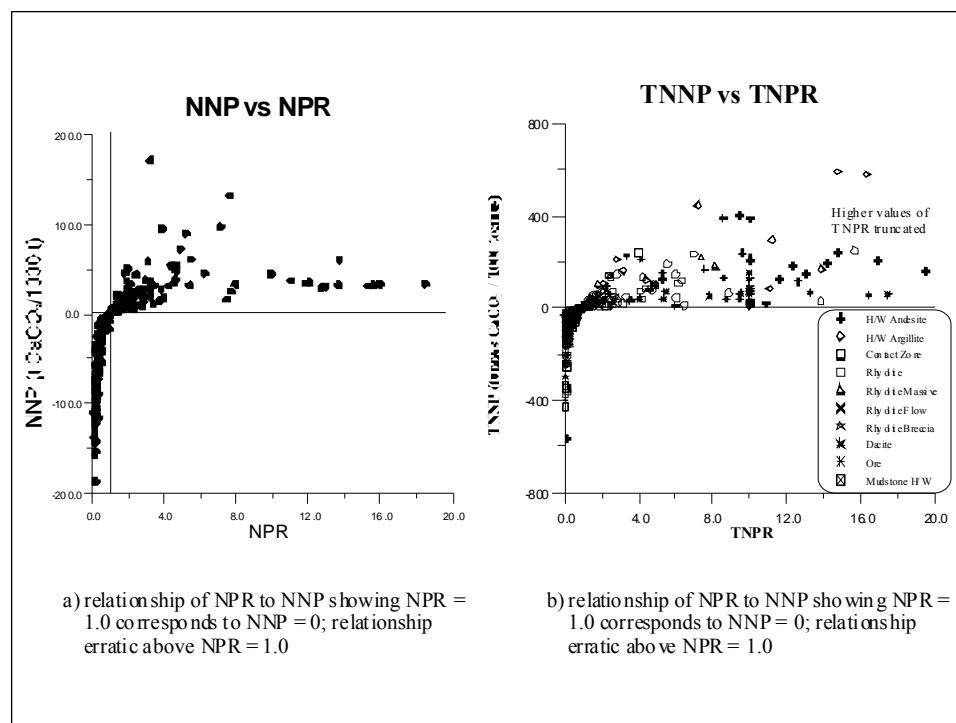


Figure 9.5 Scatterplots of xNPR vs. xNNP from B.C. mines.

### 9.3 Kinetic Tests

Kinetic tests are experimental designs that allow the ongoing measurement of weathering and leaching rates and conditions of the sample and/or the sample's drainage chemistry. Kinetic information is a critical part of drainage chemistry prediction. While previously described static tests such as Acid Base Accounting (ABA) provide data on the composition of the sample, site specific kinetic information is required to show how a material with that composition will react.

*Kinetic tests are experimental designs that allow the ongoing measurement of weathering and leaching rates and conditions and/or the resulting drainage chemistry.*

The information from kinetic testing includes:

- rates of acid generation and neutralization;
- changes in geochemical properties, such as solid phase depletion of a soluble element;
- time to net acidic conditions; and
- drainage chemistry and contaminant loadings.

The relative rates of acid generation and neutralization play a major role in determining geochemical conditions, including whether the sample will become net acidic. Time to net acidic conditions may determine how long a delay is permissible before prevention measures are required.

The information in the preceding bullet list can be estimated from measurements of the:

- weathering of acidity and contaminant sources;
- weathering of neutralizing minerals;
- weathering and leaching conditions;
- secondary mineral formation;
- solubility of the released contaminants; and
- drainage chemistry, flow rate and volume.

The weathering of acidity and contaminant sources, will naturally focus on the weathering of sulphide minerals in this Manual. The investigation of the weathering of neutralizing minerals will concentrate on carbonate minerals and whether non-carbonate minerals are capable of contributing significant NP. The investigation of secondary mineral formation and the solubility of the released contaminants includes solubility limits and other equilibrium levels.

### 9.3.1 Generic Information Requirements

Generic information requirements that should be addressed in any kinetic test, discussed further in Chapters 18 and 19, are the following:

- detailed pre-test characterization of the geological materials and project components under investigation;
- detailed pre-test static characterization of the test material;
- monitoring of drainage, weathering and leaching conditions and reaction rates and changes in the test material; and
- post-test characterization of the test material, again requiring detailed static testing.

### 9.3.2 Pre-Test Characterization of the Project Component

As one generic information requirement, detailed pre-test characterization of the weathering and leaching conditions and the properties of the project component (Chapter 7) under investigation is needed to:

- identify the properties and processes of concern;
- estimate the duration of weathering and leaching when combined with kinetic rates;
- determine the prediction questions that kinetic testing needs to answer;
- select the appropriate kinetic tests, test conditions and experimental designs;
- identify mineral sources for different chemical species in the drainage;
- determine the portion of the project component that is a concern and select samples of that material to use as test materials; and
- predict how long the kinetic test should be run to answer the prediction questions.

The properties and processes of concern will be a function of present and future weathering and leaching conditions and the properties of the project component. For example, under neutral pH and aerobic weathering conditions, the primary source of contaminants may be the dissolution of sulphate minerals and the oxidation of sulphide minerals and their contributions will change over time.

*Under neutral pH and aerobic weathering conditions, the primary source of contaminants may be the dissolution of sulphate minerals and the oxidation of sulphide minerals and their contributions will change over time.*

sulphide minerals and their contributions will change over time. Also, after a later decrease in the redox potential, a primary source of contaminants may become reductive dissolution of contaminants co-precipitated with minerals like ferric iron. This would not be detected or predicted by an aerobic kinetic test. As another example, the later onset of net acidic weathering conditions due to the depletion of neutralizing minerals may increase primary mineral weathering, contaminant solubility limits and secondary mineral dissolution.

Usually there are a number of problematic drainage chemistry properties. For example, in drainage discharge, zinc release may be the major issue in the initially neutral pH effluent while copper may be the major issue if the effluent becomes acidic. Thus, the time to net acidic drainage and the maximum acidity may be the primary properties and processes of concern for predicting and mitigating unacceptable drainage chemistry from sulphidic geologic materials.

An important consideration in the selection of kinetic tests is whether the test will measure primary mineral reaction rates (e.g. rate of sulphide oxidation, Chapter 18) or the drainage chemistry after secondary mineral precipitation and dissolution (e.g. trickle leach column or cell, Chapter 19). Usually both types of information would be important, and therefore

*An important consideration in the selection of kinetic tests is whether the test will measure primary mineral reaction rates or the drainage chemistry after secondary mineral precipitation and dissolution.*

both types of tests should be performed.

Kinetic tests should duplicate critical weathering and leaching conditions and changes in properties expected at the site and in the material. Two of the most important properties for primary mineral reaction rates and secondary mineral precipitation and dissolution are pH and Eh (redox potential). However, the impact of future pH and Eh conditions will also depend on future property changes such as the depletion of sulphide minerals or the accumulation of contaminants co-precipitated with ferric iron.

Duplicating pH and Eh conditions in tests without also duplicating other critical property changes can produce an erroneous prediction of future drainage chemistry. For example, for a sample with a large NP, artificially removing the NP at the start without similarly reducing the concentration of sulphide minerals could result in a large overestimation of the rate of sulphide oxidation at the onset of net acidic weathering conditions (Price, 2005).

Important considerations in kinetic tests measuring primary reaction rates are the possible mineral sources for a chemical species in the leachate. In other words, the measured reaction rates can reflect the individual rates of two or more minerals. A common situation where a component or reaction may mask one of the critical properties or processes is where the dissolution of gypsum or some other sulphate mineral masks sulphate release by sulphide oxidation, making it difficult to measure the rate of sulphide oxidation.

This possible masking of properties or processes should be resolved to ensure potentially important parameters can be measured and to identify situations where a component or reaction may mask one of the critical properties or processes being measured. In humidity cell testing, this should include data to support assumptions regarding the mineralogical origins of

constituents. These constituents include sulphate, base cations and any other parameters which are used to estimate rates of acid generation, neutralization, and leaching.

Potential solutions if a component or reaction may mask one of the critical properties or processes include:

- selection of more appropriate samples; or
- pretreatment of the sample to remove the offending component.

Compared with static tests, the number of kinetic tests is typically much lower and the duration and cost are much higher. Therefore, prior to selecting kinetic test material, considerable forethought is required regarding the:

- variability in the properties of the project component that may create problematic drainage chemistry;
- portion of the range that is a concern;
- levels of potentially problematic properties that need to be tested;
- required number of individual cells, columns and test pads; and
- selection of samples or materials representative of the properties that should be tested.

It is critical that kinetic tests are run on the samples of the project component that will produce problematic drainage chemistry. For example, only waste rock with the lowest 10<sup>th</sup> percentile of NP concentrations may be responsible for the first net acidic conditions, then causing other percentiles to become acidic faster. In other situations, the problematic property of the drainage chemistry will be the sum of the drainage chemistry produced by the material as a whole and thus testing should be conducted over the entire range in composition (e.g. sum of the drainage chemistry from materials with the 10<sup>th</sup>, median and 90<sup>th</sup> percentile metal concentration). Just as it is important that static testing covers the entire range in geological, geochemical, physical, weathering and leaching conditions, it is important that kinetic testing cover the entire range for the portion of the project component that is a concern.

The design of a kinetic test program should use detailed static test information on the

*Detailed static test information should demonstrate that the kinetic test samples do represent the intended portion of the project component.*

composition of the project component and the test materials, showing that the test materials have the composition of the portion of the project component they are intended to represent. For example, if the problematic property of the drainage chemistry is

the onset of net acidic conditions, the test materials should be representative of the material with the lowest carbonate content, lowest neutralizing potential and lowest ratio of these parameters to the acid potential (NPR values). If the problematic property of the drainage chemistry is elevated copper in near-neutral drainage, the test materials should be representative of the material with the highest concentrations of dissolvable copper, total copper and reactive copper minerals and the lowest concentrations of any components that may limit reaction of copper minerals or the solubility limits for copper.

In some situations it may take years, even decades, to reach the weathering conditions or material properties of concern with regards to drainage chemistry. The duration of kinetic tests

to answer the prediction questions should be estimated prior to initiating kinetic test work to ensure:

- data will be available when needed to make management or regulatory decisions;
- resources are available to continue the tests as long as needed; and
- other prediction or management measures are selected if the data will not be available in time.

### 9.3.3 Selection of Kinetic Tests

Kinetic testing requires field situations and/or laboratory test procedures that include the desired weathering and leaching conditions with the materials of interest. Kinetic testing includes a variety of procedures, measuring a wide variety of properties and processes. Test selection should be based on the prediction questions, the predicted weathering and leaching conditions and the properties being tested.

The benefits and potential limitations should be considered when selecting a kinetic test and

*Kinetic tests are not interchangeable and one should be aware of the differences when selecting a test and interpreting or reviewing the results.*

interpreting or reviewing its results. Kinetic tests are not interchangeable and one should be aware of the differences when selecting a test and interpreting or reviewing the results. Test selection and the assessment of test results should include

consideration of the possible differences between the kinetic test and the project component. They should also consider the time periods under investigation and their effects on properties such as weathering and leaching conditions, mineral availability and exposure and contaminant concentrations and solubility.

Factors to consider in test selection include the following:

- whether the test occurs in the laboratory, at the mine site or at some other suitable field site;
- the scale of the test - full or reduced;
- differences among the tests in weathering and leaching conditions and inputs and how this may alter weathering properties and processes; and
- whether the measurement objective is the drainage chemistry or the rate of primary mineral weathering.

Measurement of primary mineral weathering requires an action to remove the solubility constraints. Usually this is accomplished with aggressive leaching or flushing that limits secondary mineral precipitation. Measurement of drainage chemistry and primary mineral weathering are often mutually exclusive.

Large disparities may exist between laboratory kinetic tests and on site kinetic tests at the mine due to differences in sample preparation, climatic conditions, sample size, scale and in the case of waste rock, particle size.

One of the most critical aspects, and a common source of error when it is not recognized, is the distinction between tests designed to measure kinetically limited primary mineral weathering reactions and those designed to measure the drainage chemistry primarily resulting from equilibrium controlled secondary mineral precipitation and dissolution. Some humidity cell tests

have specific requirements that allow them to measure primary mineral weathering and it is important to follow their procedures closely.

Potential sources of kinetic data include the following:

- natural non-lithified surficial material (e.g. talus) and outcrops from materials with a geological and geochemical composition similar to the material of concern, and that have been exposed to similar weathering and leaching conditions;
- other site materials with a similar geological and geochemical composition and weathering and leaching conditions;
- laboratory humidity cell tests;
- laboratory trickle leach columns;
- wall washing stations;
- field test pads; and
- full-scale project components.

A synopsis of the probable test conditions for various kinetic tests is shown in Table 9.3. More detailed descriptions of humidity cell and kinetic tests that measure primary mineral weathering and secondary mineral precipitation and dissolution are provided in Chapters 18 and 19.

**Table 9.3 A synopsis of typical test conditions for various kinetic tests.**

Test Procedure	Field/Lab	Scale	Primary Weathering	Drainage Chemistry
Humidity Cell	Lab	Bench, < 6 mm particles	Yes	Estimate with geochemical models
Column	Lab	Bench to pilot	No	Yes
Field Test Pads	Field	Pilot	No	Yes
Wall Washing Stations	Field	1 m <sup>2</sup>	Maybe	Estimate with geochemical models
Site Drainage	Field	Full	No	Yes

### 9.3.4 Pre-Test Characterization of the Test Material

Detailed pre-test characterization of the test material is required to:

- check that samples are representative of the properties that need to be tested and the portion of the project component that is a concern;
- allow the extrapolation of measured reaction rates to materials with different surface areas and concentrations of minerals;
- identify mineral sources for different chemical species in the leachate;
- predict how long the kinetic test will need to run to answer the prediction questions; and
- in conjunction with results from post-test characterization, provide a check on results of other forms of monitoring and measure the amount and type of precipitation and removal of weathering products.

The analyses for pre-test characterization should consist of the following:

- total elemental analysis;
- soluble constituents;
- sulphur species, including sulphide, leachable sulphate and total sulphur;
- bulk and carbonate based Neutralization Potential;
- particle size analysis; and
- petrographic and X-ray Diffraction mineralogical determinations.

Other forms of analysis, such as SEM/EDS or microprobe, may be needed depending on the results (Chapter 17).

### 9.3.5 Monitoring during the Test

Monitoring requirements during the test will depend on the objectives and type of test. Properties that may be monitored include:

- regular sampling and geochemical analysis of the discharged drainage;
- chemistry of drainage inputs;
- changes in colour;
- gas phase and drainage chemistry within a column, test pad or project component; and
- oxygen consumption.

Regular sampling and geochemical analysis of the discharged drainage is a requirement of almost all kinetic tests, although the analyzed parameters and the sampling frequency will depend on the test. Analyses of drainage chemistry generally include pH, conductivity, total dissolved solids, hardness, acidity, alkalinity (pH 8.3), sulphate, chloride, fluoride, nitrate, phosphate and dissolved ICP elements including arsenic, mercury, selenium and other chemical species of site-specific concern. A full suite of analyses will be required for geochemical modeling (Chapter 20). Indicator parameters should be measured in every sample, but it may be possible to measure the full suite of analyses needed for geochemical modeling less frequently.

*Regular sampling and geochemical analysis of the discharged drainage is a requirement of almost all kinetic tests, although the analyzed parameters and the sampling frequency will depend on the test.*

Wherever drainage chemistry is measured, drainage flow rates (volume per unit time) should

*Wherever drainage chemistry is measured, drainage flow rates (volume per unit time) should also be measured, in addition to drainage concentrations, to permit calculation of reaction rates and downstream loadings.*

also be measured, in addition to drainage concentrations, to permit the calculation of reaction rates and downstream loadings (Figure 9.6). The location, flow rate and volume of water should

be measured because changes in drainage chemistry may result from changes in these properties rather than changes in geochemistry.



**Figure 9.6** Monitoring of the rate and volume of flow are needed to calculate contaminant loadings.

In addition to the discharged drainage, sampling and analysis can be done on the solid phase and the porewater and groundwater within the test material or project component so long as the test conditions are not disrupted. Data from monitoring of internal temperature and oxygen concentrations may also reflect the rate of sulphide oxidation.

An important source of information that should be monitored for both laboratory and field studies are influential climate properties such as precipitation and snow fall (Section 6.3).

### **9.3.6 Post-Test Characterization of the Test Material**

Detailed post-test characterization of the test material, in conjunction with results from pre-test characterization, is required to:

- check the results of other forms of monitoring;
- measure the amount and type of precipitation of weathering products; and
- identify the minerals in the initial test material that did not react.

The analyses should be the same comprehensive static testing as conducted prior to the test (Section 9.3.4).

## **9.4 References**

Price, W.A. 2005. Case Studies of ML/ARD Assessment and Mitigation: Snip Gold Mine. MEND Report 9.1c.

Sobek, A.A., W.A. Schuller, J.R. Freeman and R.M. Smith. 1978. Field and Laboratory Methods Applicable to Overburdens and Minesoils. Report EPA-600/2-78-054, U.S. National Technical Information Report PB-280 495.



## 10.0 WHOLE-ROCK AND NEAR-TOTAL SOLID PHASE ELEMENTAL ANALYSIS

### *Some Important Points in this Chapter*

*The analyses discussed provides the total or near-total amounts of selected chemical elements in a solid phase sample. This is accomplished in two major steps. First, most or all of a sample is digested in a hot chemical flux or strong acid combination. Second, the digested sample is analyzed by one of several techniques, such as X-ray Fluorescence (XRF) or Inductively Coupled Plasma (ICP). It is important to be aware of the strengths and weaknesses of each method of digestion and analysis because it may affect predictions of drainage chemistry from sulphidic materials. For example, whole-rock analyses may be reported as oxide equivalents, such as CaO and Al<sub>2</sub>O<sub>3</sub>, which require mathematical conversions to obtain pure element concentrations. These analyses do not reveal the forms in which an element occurs, such as in one or more minerals, although this can sometimes be estimated using a few assumptions. Also, solid phase levels, whether high or low are not on their own measures of the potential aqueous concentrations in drainage or of the threat to the environment. However, tests in other chapters are combined with these solid phase results for drainage predictions, such as the length of time until elements are fully leached from a sample.*

### 10.1 Introduction

Whole-rock or near-total solid phase elemental analysis is used to quantify elemental concentrations in rock materials that may be exposed through mining activities. Information regarding solid phase elemental abundance represents a key component of mine waste geochemical characterization and accordingly, such analyses should be conducted on all geologic materials impacted by a mine or project. The initial solid phase elemental data often comes from sampling and analyses conducted as part of geochemical exploration. More comprehensive sampling and analysis is usually conducted as part of pre-mine planning, with regular operational characterization used for verification and filling data gaps.

*These analyses should be conducted on all geologic materials impacted by a mine or project.*

### 10.2 Objectives

The primary objective of whole rock or near-total solid phase elemental analysis is to determine the concentration of elements that are drainage chemistry concerns (e.g. metals and metalloids). Other uses for the results include the following:

- check whether trace elements of potential concern occur in elevated concentrations compared with concentrations normally found in rock and soil at the site or more universally;
- estimate trace element depletion times;

- determine the maximum potential contribution of acid insoluble sulphate minerals (barite [BaSO<sub>4</sub>], anglesite [PbSO<sub>4</sub>] and celestite [SrSO<sub>4</sub>]) to the estimates of sulphide-S and AP (Chapter 12);
- determine the maximum potential contribution of less acid generating sulphide minerals than pyrite to compare to the estimates of sulphide-S and AP (Chapter 12);
- identify samples with elemental levels indicative of anomalous geochemical conditions;
- verify the predicted lithological classification and mineralogical composition; and
- estimate the concentrations of constituents that may control important properties of the drainage chemistry (e.g. neutralizing minerals).

### 10.2.1 Limitations

Whole rock and near-total solid phase elemental analysis provides limited information about the form (e.g. mineral) in which the elements exist and on its own is not a measure of the potential concentrations in drainage or the threat to the environment. There are a large number of properties and processes that determine whether solid phase elements will report to drainage. These include:

- the elemental forms present (i.e. mineralogical associations) and whether the forms are relatively soluble or will become more soluble through processes such as oxidation;
- environmental conditions (e.g. sub-aerial versus saturated storage conditions, climate, etc.); and
- volume, chemistry and flow rate of the drainage.

Information on the mineralogy (Chapter 17), geochemical conditions and rates of weathering (Chapters 18 and 19), secondary mineral solubility (Chapters 19 and 20) and the resulting drainage chemistry are required to interpret the environmental significance of solid phase elemental analysis results.

Relatively high elemental concentrations will not result in elevated aqueous concentrations in drainage, if their mineral form is relatively insoluble or unalterable, or if the weathering conditions are not conducive to elemental mobility. An example of this is the relative stability of copper that is often observed in weathered rock materials (e.g. zones of supergene enrichment) given the sparingly soluble nature of such materials under specific conditions. Conversely, if the element is in a form that is very soluble or will become more soluble due to weathering, normal or relatively low solid phase elemental concentrations may result in high concentrations in mine drainage. An example of a relatively rapid weathering reaction that increases solubility is sulphide oxidation under aerobic, low pH weathering conditions.

*Relatively high solid phase elemental concentrations will not result in elevated aqueous concentrations in drainage.*

### 10.2.2 Overview of the Methods

There are a large number of possible methods for measuring the whole rock or near-total solid phase elemental concentration. Some methods measure the concentration of a single element. Other methods simultaneously measure the concentration of a large number of elements. Multi-element methods are most commonly used due to their cost-effectiveness. Methods that measure

the concentration of a single element are generally used when the equipment for multi-element analysis is unavailable or the element is not amenable to multi-element techniques.

Most methods for measuring the whole rock or near-total solid phase elemental concentration

*Most methods for measuring the whole rock or near-total solid phase elemental concentration typically have two stages: 1) digestion of the sample in acid to release the elements into a measurable form; and 2) analysis of the concentrations of the elements in the resulting digestion.*

typically have two stages: 1) digestion of the sample in acid to release the elements into a measurable form; and 2) analysis of the concentrations of the elements in the resulting digestion. More than one method for the multi-element analysis can generally be used with each method of digestion and vice versa. For example, X-ray Fluorescence Spectroscopy (XRF), Inductively Coupled Plasma (ICP) or

Atomic Absorption Spectroscopy (AAS) can all be used to measure the elemental concentration after digestion by Lithium Borate fusion. ICP or AAS can also be used for analysis after wet digestion by a strong acid method, such as four acid (HF-HNO<sub>3</sub>-HClO<sub>4</sub>-HCl) or aqua regia (HCl-HNO<sub>3</sub>) digestions. There are two common ICP options for analysis, Atomic Emission Spectroscopy (AES) or Mass Spectroscopy (MS). Non destructive methods for trace element analysis (i.e. those not requiring digestion) include XRF which is conducted using pressed powders.

### 10.3 Methods of Sample Digestion

The purpose of sample digestion is to release elements from the mineral phase into a phase in which they can be analyzed (e.g. liquid solution or glass disk). Digestion methods vary in their ability to digest different minerals and therefore the proportion of the sample they are able to digest. Digestion methods also vary in their susceptibility to interference by sample properties such as sulphide content. The best detection method will depend on the degree of digestion required, sample mineralogy and the intended use for the results. Lithium borate fusion completely digests most samples, providing whole rock elemental results. Lithium borate is the recommended procedure if the objective is to measure the total concentration of major mineral forming cations. Sodium peroxide fusion can be used as a replacement for lithium borate fusion to measure the total concentration of major mineral forming cations when the sulphide mineral concentration is > 5%.

The two most common wet acid digestions are the four acid and aqua regia procedures. The four acid digestion (hydrofluoric, perchloric, nitric and hydrochloric acids) produces near-total solid phase elemental results. Aqua regia (hydrofluoric and nitric acids) is weaker and produces partially digested solid phase elemental results. The lithium borate fusion, and the four acid and aqua regia procedures all digest sulphides, carbonates, sulphates and oxides and therefore provide a good measure of the total concentration of solid phase trace elements in the most reactive minerals. Silicate minerals, which are typically not as environmentally significant, are not wholly digested with aqua regia. Limitations in the degree of digestion should be indicated when using and communicating solid phase elemental results.

The more complete the digestion, the higher the concentration of total dissolved solutes and the greater the dilution required in the subsequent analysis, resulting in higher minimum detection limits. Consequently, aqua regia has a slightly lower minimum detection limit than the four acid digestion for some trace elements, and both aqua regia and four acid digestion have lower minimum detection limits than lithium borate fusion.

An assessment of the sulphur content, ideally a total-S analysis by the specialty Leco Furnace (Chapter 12), which is part of ABA, should be conducted in advance of solid phase elemental analysis to detect samples where elevated sulphide may interfere with the analysis.

### 10.3.1 Lithium Borate Fusion

In lithium borate fusion, a finely ground sample is mixed with lithium borate flux to lower the melting point. The mixture is then fused (i.e. heated until molten) in a furnace. The flux is usually lithium tetraborate ( $\text{Li}_2\text{B}_4\text{O}_7$ ), lithium metaborate ( $\text{LiBO}_2$ ) or a mixture of the two. The temperature in fusion with lithium tetraborate ( $\text{Li}_2\text{B}_4\text{O}_7$ ), which has a melting point of  $920^\circ\text{C}$ , is approximately  $1100^\circ\text{C}$ . The temperature in fusion with lithium metaborate, which has a melting point of  $845^\circ\text{C}$ , is approximately  $1000^\circ\text{C}$ . Fusion produces a glass disc.

Analysis of the fused glass disc is traditionally done directly by XRF (Section 10.4.1). The minimum detection limit for trace elements can be lowered by dissolving the fused disc in a known volume of 4-5% nitric acid and analyzing the resulting solution with an ICP technique (Section 10.4.3).

Lithium borate fusion is very effective in dissolving cations bonded with oxygen (e.g. oxides, carbonates, silicates and sulphates) and unlike wet acid digestion methods is able to completely digest major rock forming minerals. Lithium borate fusion is therefore used to measure the total concentration of common major mineral forming cations: Al, Ba, Ca, Cr, Fe, K, Mg, Mn, Na, P, Si, and Ti. The results are referred to as whole rock analysis and are often reported as oxide equivalents (e.g.  $\text{MgO}$ ,  $\text{Fe}_2\text{O}_3$ ).

The high temperature of fusion techniques results in the loss of volatile species (e.g.  $\text{CO}_2$  from carbonates and water from phyllosilicates and/or hydrated minerals). Measurement of loss of weight on ignition (LOI) should be conducted along with fusion techniques as a check on the mass of these species and whether the sum of the oxide equivalents approaches 100%.

Other considerations to take into account include:

- fused sample disks can be stored indefinitely if additional analyses are required;
- sample fusion enhances XRF analysis by minimizing particle size effects;
- samples with elevated sulphide mineral concentrations do not fuse well with lithium borate and the sample may dissolve slowly, preventing a clean disk from being produced and causing signal interference that prevents optimum detection limits from being achieved in the subsequent XRF analysis. Lithium borate fusion and analysis by XRF is not recommended for samples with  $\geq 5\%$  sulphide minerals. If samples have elevated sulphide and/or metal contents, the proponent should discuss the nature of the samples and the digestion and analysis procedures with analytical personnel. One option for samples with

- ≥ 5% sulphide minerals is to use sodium peroxide fusion (Section 10.3.2), instead of the more common borate fusion. Another option is analysis by an ICP technique; and
- high concentrations of metals such as Cu and Zn can damage the crucibles used for lithium borate fusion.

### 10.3.2 Sodium Peroxide Fusion

Sodium peroxide ( $\text{Na}_2\text{O}_2$ ) flux is an aggressive flux used to digest samples with ≥ 5% sulphide minerals or other refractory or resistant minerals. In the sodium peroxide fusion method, sodium peroxide and sodium hydroxide are added to the sample, which is heated to 550°C. Diluted nitric acid is used to dissolve the digested residue and the resulting solution is analyzed by an ICP or other wet analysis method.

Since sodium peroxide fusion results in complete sample dissolution, the analyte solution has a high salt content and typically needs to be diluted prior to analysis, increasing the detection limits for trace elements.

### 10.3.3 Four Acid Method

The four acid method uses hydrofluoric acid, perchloric acid, nitric acid and hydrochloric acid. First a mixture of hydrofluoric acid, perchloric acid and nitric acid are added to a finely ground sample. The acid mixture is then taken to near dryness to allow the reaction to go to completion. Lastly, the nearly dry cake is leached with hydrochloric acid to further the digestion and dissolve the residue. The resulting solution can be analyzed by an ICP or another wet analysis method.

Wet acid digestions are classified as “near total” or “partial” depending whether they are capable of fully dissolving the element(s) of interest. The four acid method is the most powerful wet acid dissolution procedure in common use and is considered a near total digestion. Although the lower digestion temperature makes it less able to digest silicates than fusion methods, the four acid method is capable of dissolving most metal salts, carbonates, sulphides, silicates and almost all sulphates and oxides. The addition of hydrofluoric acid makes the four acid method procedure significantly more effective at breaking down silicate minerals than the aqua regia digestion.

*Wet acid digestions are classified as “near total” or “partial” depending whether they are capable of fully dissolving the element(s) of interest.*

Elements whose concentrations may be underestimated due to incomplete digestion by the four acid digestion include rare earths and Ba, Sn, Ta, Ti, W, and Zr. The four acid method is also only able to partially digest massive sulphide samples and large amounts of sulphide will result in the formation of sulphate, which may precipitate if combined with barium and lead.

Care must be taken during the drying step of the four acid method not to continue beyond near dryness as this could result in a loss of elements by volatilization (e.g. Au, As, Cr, and Sb). There have also been reports of volatilization causing a loss of sulphur (as hydrogen sulphide) in samples containing pyrrhotite.

### 10.3.4 Three Acid Method

The three acid digestion differs from the four acid digestion by not using hydrofluoric acid, which makes the digestion of silicates less complete. This strong acid digestion is capable of dissolving most metal salts and carbonates.

### 10.3.5 Aqua Regia

In the aqua regia digestion, the sample is digested in a heated water bath with a 3:1 mixture of hydrochloric and nitric acids (aqua regia). Nitric acid destroys organic matter, oxidizes sulphide material and reacts with concentrated hydrochloric acid to generate aqua regia according to the following reaction:  $3 \text{HCl} + \text{HNO}_3 = 2 \text{H}_2\text{O} + \text{NOCl} + \text{Cl}_2$ . After cooling, the digest solution is diluted with distilled water and analyzed.

Aqua regia is an effective solvent for most base metal sulphates, sulphides, oxides and carbonates, but provides only a partial digestion for most rock forming elements and elements of a refractory nature. It is typically less expensive and does not provide as complete a digestion as the four acid method. Elements commonly occurring in minerals that are not digested by aqua regia and whose concentrations may be underestimated due to incomplete digestion include: Al, B, Ba, Be, Ca, Ce, Cr, Cs, Ga, Ge, Hf, In, K, La, Li, Mg, Na, Nb, Rb, Re, S, Sb, Sc, Sn, Sr, Ta, Te, Th, Ti, Tl, W, Y and Zr.

*Aqua regia is an effective solvent for most base metal sulphates, sulphides, oxides and carbonates, but provides only a partial digestion for most rock forming elements and elements of a refractory nature.*

## 10.4 Methods of Analysis

Methods of analysis vary in the type of sample that can be analyzed, instrumentation, detection methods, elements measured, detection limits and susceptibility to interference by other sample components (e.g. sulphide content). Elemental analysis by XRF is done on glass disks and solid, undigested samples (e.g. pressed pellets). More commonly, elemental analysis is conducted on liquid samples created by digesting and dissolving the sample with strong acids.

### 10.4.1 X-ray Fluorescence Spectroscopy (XRF)

In XRF analysis, a beam of primary X-rays irradiate the sample. Constituent elements emit fluorescent (secondary) X-rays when a primary X-ray of sufficient energy strikes an atom in the sample, dislodging an electron from one of the atom's inner orbital shells (lower quantum energy states). The atom regains stability by filling the vacancy in the inner orbital shell with an electron from one of the higher quantum energy orbital shells. The electron drops to the lower energy state by releasing a fluorescent X-ray. Each element emits a unique fluorescent X-ray energy spectrum (energies and wavelengths) that can be used to identify the elemental source because the quantum state of each electron orbital shell in each atom is different.

Diffraction crystals are used to disperse and sort the emitted fluorescent X-rays by wavelength. The dispersed fluorescent X-rays strike a detector causing a small electrical impulse. The element concentration in the sample is then determined by comparing the electrical impulse of the characteristic wavelengths to that of standard reference materials.

The most common use of XRF is to measure the concentrations of major elements (e.g. Al, Ba, Ca, Cr, Fe, K, Mg, Mn, Na, P, Si, and Ti) in a lithium borate fused disk. XRF can also be used to measure the concentrations of trace elements, such as: As, Ba, Ce, Cu, La, Nb, Ni, Rb, Sn, Sr, Ta, Th, U, W, Y, Zn, and Zr in an undigested pressed pellet. The pellet is created with a bonding agent under high pressure to ensure sample integrity under the vacuum and a consistent surface to receive the X-rays.

Reduced accuracy of XRF measurements may result from:

- geometric effects caused by the sample's shape, surface texture, thickness and density;
- spectroscopic interferences and other sample matrix effects; and
- absorption of fluorescent X-rays by other elements in the sample, and secondary and tertiary X-ray excitation by other elements in the sample.

Certain metals can interfere with the analysis of other metals. For example, iron tends to absorb copper X-rays and enhances the emission of X-rays from chromium. Modern XRF instruments have software that mathematically corrects for these types of interferences.

Other points to consider are:

- if the composition of the sample cannot be matched closely to the calibration standards, empirical correction factors have to be applied;
- XRF is not suitable for measuring lighter elements, like lithium, which produce lower energy XRF emissions with lower penetrating power, ICP is better suited to the detection of lighter elements; and
- XRF has relatively high minimum detection limits and other analysis techniques such as ICP or AAS are recommended for measuring trace element concentrations (i.e. < 100 ppm).

#### 10.4.2 Field Portable and Hand Held XRF Instruments

Field portable and hand held Energy Dispersive X-ray Fluorescence (EDXRF) analyzers are

*The main disadvantages of field portable and hand held XRF are the low precision and accuracy resulting from sample heterogeneity, the small field of view, sample matrix effects, the difficulty in maintaining the distance to the sample, limitations of the instruments in the resolution for some elements, and limited calibration.*

relatively inexpensive and able to provide real time data and may be a cost-effective analytical solution where qualitative or semi-qualitative data is sufficient and there is little time available for analytical feedback (Guerin

et al., 2006). The main disadvantages of field portable and hand held XRF are the low precision and accuracy resulting from sample heterogeneity, the small field of view, sample matrix effects, the difficulty in maintaining consistent distances between the instrument and the sample, limitations of the instruments in the resolution for some elements and limited calibration.

Field portable XRF instruments measure the composition over a surface area of approximately one square centimeter and to a depth of approximately 2 millimeters. The small width and depth of view make it possible to measure the spatial variability and the composition of discrete areas such as veins or surface coatings. Measurements at a number of different locations and removal of surface coatings will be required to determine the overall composition of rock samples.

Unconsolidated samples should be homogenized prior to analysis if the objective is to determine the overall composition.

Sieving can be used to create a more uniform particle size. Soil moisture contents above 20 percent that can interfere with the analysis can be minimized by drying, preferably in a convection or toaster oven. The effect of moisture on XRF results will depend on the composition of the sample and drying may not be required.

The strength of the X-ray signal decreases as the distance from the radioactive source increases and it is important to maintain a consistent distance between the window and the sample. For best results, the window of the probe should be in direct contact with the sample.

Resolution may be a problem in analyzing some elements with field portable XRF instruments. For example, concentrations of arsenic often cannot be measured accurately for samples that have lead to arsenic ratios of 10 to 1 or more because the lead peak masks the arsenic peak.

### **10.4.3 Inductively Coupled Plasma**

In Inductively Coupled Plasma (ICP) analysis, liquid samples are nebulized and the resulting aerosol is transported by argon gas into a plasma torch. Radio frequencies in the torch create extremely high temperatures within the plasma of partly ionized argon gas, removing any remaining solvent and causing the samples to atomize and the analyte species to become thermally excited. The mass of the ions (Mass Spectroscopy - ICP-MS, Section 10.4.5) or the intensity of characteristic radiation (Emission Spectroscopy - ICP-AES, Section 10.4.4) produced by the thermally excited analyte species are used to measure elemental concentrations in the sample.

ICP procedures have the capability to measure the concentration of many elements simultaneously (up to 70 in theory and commonly over 40 in practice), many more elements than can be determined with XRF analysis. Like Atomic Absorption Spectroscopy (AAS), ICP-AES and ICP-MS also benefit from high sensitivity and accordingly low detection limits.

Other comments include:

- ICP instruments are highly automated, enhancing analysis speed, accuracy and precision;
- highly skilled staff are required to operate, repair and maintain these complex instruments; and
- high concentrations of sulphide minerals and iron may cause signal interference, preventing optimum detection limits from being achieved. The concentrations of sulphide minerals and iron and the impact on the detection limits will depend on the laboratory procedures and equipment.

### **10.4.4 Inductively Coupled Plasma Atomic Emission Spectroscopy (ICP-AES)**

In Inductively Coupled Plasma Atomic Emission Spectroscopy (ICP-AES), light emitted by the thermally excited atoms is collected by a spectrometer. In the spectrometer, the light, which is characteristic of the elements in the sample, is passed through a diffraction grating that separates it into a spectrum of its constituent wavelengths. Each wavelength of diffracted light is collected



and amplified to yield an intensity measurement, which is converted to an elemental concentration using calibration standards.

Other comments include the following:

- the emission spectra are complex and inter-element interferences are possible (e.g. one phosphorus wavelength has both copper and aluminum interference; and
- rigid control of the temperature and humidity must be maintained for stable performance of the spectrometer.

#### 10.4.5 Inductively Coupled Plasma Mass Spectroscopy (ICP-MS)

In Inductively Coupled Plasma Mass Spectroscopy (ICP-MS), the mass of the ions produced by the thermally excited analyte species in the plasma are introduced into a mass spectrometer. The mass spectrometer separates and collects the ions according to their mass to charge ratios and quantifies them with a channel electron multiplier. The concentration of each element in the sample is determined by comparing the intensity of the electron signal to that of known standards. There are several different types of mass analyzers which can be employed to separate isotopes based on their mass to charge ratio.

ICP-MS is capable of very low detection limits for a wide range of elements with detection limits

*ICP-MS is capable of very low detection limits for a wide range of elements, detection limits lower than those of ICP-AES and graphite furnace atomic absorption spectroscopy.*

lower than those of ICP-AES and Graphite Furnace Atomic Absorption Spectroscopy (Section 10.4.6). ICP-MS is also a good alternative measurement technique for elements not easily measured by ICP-AES or Atomic Absorption Spectroscopy and is capable of discriminating between the mass of the

various isotopes where more than one stable isotope of an element occurs.

Other comments include the following:

- ICP-MS is used if ultra-trace geochemical analysis is required (e.g. after sequential extraction or selective leaches) because of its high sensitivity and low detection limits. The ultra-pure acids required for sample digestion prior to ultra-trace geochemical analysis can increase the costs;
- instrument performance is reduced if the total dissolved solute concentration of the sample solution is too high. Dilution of the sample solution required to lower the total dissolved solute concentration can result in higher detection limits for some elements;
- interference from some common matrix elements and other molecular species can affect the measurement accuracy for some base metals (e.g. chloride can interfere with a number of elements and ArCl has the same mass as arsenic). However, the advent of high resolution detectors now permits separation of species with similar mass to charge ratios, thus minimizing the effects associated with such spectral interferences; and
- some doubly charged ionic species create difficulties.

### 10.4.6 Atomic Absorption Spectroscopy (AAS)

In Atomic Absorption Spectroscopy (AAS), liquid or solid samples are converted into the gas phase (vaporized) by the high temperature of a flame, a graphite furnace or chemical reaction (hydride generation). The vaporized atoms are then introduced into a beam of ultraviolet or visible light with the same wavelength as the element of interest. The vaporized atoms absorb the light and make transitions to higher electronic energy levels. The concentration of the element in the sample is determined by comparing the amount of light absorption with that of standards with known concentrations.

Advantages of AAS are that it is well established, the equipment is relatively easy to use and inexpensive and the technology is straightforward and well understood. AAS can measure a wide range of concentrations for most elements and has relatively few interferences. The main disadvantage is that AAS only analyses one element at a time. The technique becomes uneconomic if analysis of a large number of elements is required. Although relatively rare, interference by other elements or chemical species can reduce the sensitivity.

### 10.4.7 Neutron Activation

Neutron Activation Gamma Spectroscopy analysis is a non-dissolution method and often the method used for Br, Cl, I and U analysis. Neutron activation is also used in exploration as it has a low detection limit for gold and gold related trace elements. Due to the lower detection limits compared to most other analysis procedures, neutron activation analysis can be used to check results from other procedures. A disadvantage of this procedure is the possibility of matrix interference by mineralized samples.

## 10.5 Other Analytical Methods

There are a number of other digestion and analytical methods that can be used to quantify the solid phase concentrations of specific elements. They include: Leco furnace methods, gravimetric and volumetric (titrimetric) procedures and ion specific electrodes. Many of these methods have a long history of use. The Leco furnace is the most common method for total carbon and sulphur analysis (Chapters 12 and 13). Gravimetric and volumetric (titrimetric) procedures are used instead of multi-element procedures when the element concentration exceeds the maximum detection limit and to measure a particular elemental species, such as non-sulphide copper or zinc.

In gravimetric methods, the element of interest is precipitated as an insoluble compound, which can be separated and weighed. The weight of the compound is used to calculate the concentration of constituent elements. One of the more common gravimetric analyses is the precipitation of the highly insoluble compound barium sulphate, which is used to calculate the concentration of barium.

In volumetric or titrimetric methods, the concentration of the element in a solution of the digested sample is calculated from the amount of reacting species that must be added to completely react with the element of interest. The amount of the reacting species is calculated by determining the volume that was added of a standard solution with a known concentration. A chemical or electronic indicator is used to signal completion of the reaction between the element of interest and the reacting species.

Specific ion electrodes measure the potential difference between a standard ion electrode and a solution of the same ion. Examples include the specific ion electrodes used to determine the concentration of fluoride or chloride.

## 10.6 Reporting of Results as Oxide Equivalents

Whole-rock fusion technique results for major cations are usually reported as oxide equivalents

*Whole-rock fusion technique results for major cations are usually reported as oxide equivalents, but often the elements do not occur as these oxide minerals.*

with the cation balanced with oxygen (e.g.  $\text{Al}_2\text{O}_3$  and  $\text{MgO}$ ). This does not mean that the cations in the sample necessarily occur in these oxide forms - in many cases, they do not. Elemental concentrations can be derived from

the oxide concentration from the atomic weight ratios.

The sum of a whole-rock analysis as oxide equivalents, including Loss On Ignition (LOI), will typically be close to 100%, hence the term “whole-rock”. LOI reflects volatilized elements not included in the analysis, like sulphur ( $\text{SO}_2$ ), carbon ( $\text{CO}_2$ ) and water of crystallization ( $\text{H}_2\text{O}$ ). A significant deviation from 100% can indicate an analytical error or the presence of anomalous levels of sulphides, carbonates, phyllosilicates and/or hydrated minerals.

## 10.7 Use of the Results

### 10.7.1 Compare with Concentrations in Non-Mineralized Rock and Soil

One use of solid phase element data is to identify trace elements that may be of potential concern in mine drainage. This can be achieved through comparison of the sample concentrations with the upper concentrations found in non-mineralized rock and soil. Where the trace elements occur in relatively reactive minerals (e.g. sulphides and carbonates), this comparison is useful in identifying which elements are more likely to be a concern.

### 10.7.2 Calculate Depletion Times and Duration of Leaching

Another potential use for solid phase total element data is in conjunction with the release rates measured in kinetic tests to calculate mass depletion times. For example, solid phase total zinc concentrations coupled with humidity cell measurements of the zinc release rates can be used to calculate the time to deplete zinc in the solid phase sample.

Some of the many factors that influence depletion rate and that warrant consideration in the calculation and use of depletion times include:

- differences between the kinetic test and the mine component in properties that control release rates, such as mineral exposure, rate of leaching per unit surface area or mass and the temperature; and
- future changes in geochemical conditions or the depletion of one of several mineral sources for the element that may change the depletion rate.

The larger mass and scale of full-scale mine components compared to a humidity cell often increase solute concentrations above solubility limits resulting in the precipitation of secondary minerals and the lowering of bulk depletion rates. Trace elements may occur in a number of different minerals that weather at different rates. For example, zinc may occur as major structural components or trace constituents in sphalerite, tennantite, tetrahedrite, various oxide and carbonate minerals, and pyrite. The relative release rates from different minerals may fluctuate with changes in the geochemical conditions. Microprobe or other mineralogical information is required to determine potential mineral sources for an element.

### 10.7.3 Estimate the Concentrations of Different Minerals

Total solid phase elemental data can be used to estimate maximum potential concentrations of certain minerals. For example, the maximum amount of sphalerite can be calculated by assuming all measured zinc occurs as this one mineral. This amount can then be subtracted from measured sulphur to determine the minimum amount of other sulphur bearing minerals. Thus, calculations of mineral concentrations in this way are based on assumptions about the mineral sources for the elements. These calculations can be verified using mineralogical tests (Chapter 17).

*Total solid phase elemental data can be used to estimate maximum potential concentrations of certain minerals.*

Software exists to calculate mineralogy from total element data. However, the large and heterogeneous mixtures of minerals found at many sites, especially after weathering and oxidation begin, cannot often be calculated reliably.

### 10.7.4 Estimate Maximum Potential Concentration of Acid Insoluble Sulphate

As part of Acid Base Accounting (ABA) (Chapter 14) and sulphur species determination (Chapter 12), potentially acid generating sulphide can be calculated by subtracting measured acid soluble sulphate from measured total sulphur. However, this approach leads to relatively acid insoluble sulphate minerals, like barite, to be considered sulphide. Total solid phase elemental concentrations can be used to determine whether the maximum potential contribution of acid insoluble sulphate to the calculated sulphide is significant and requires corrections.

Total concentrations of barium and lead can be used to calculate the maximum potential concentration of the primary acid insoluble sulphate minerals barite [ $\text{BaSO}_4$ ] and anglesite [ $\text{PbSO}_4$ ], based on the ratio of their molecular weight to that of sulphur and the assumption that these minerals are the only source for these elements:

1.  $\% \text{Ba} \times (32.07/137.3) = \% \text{Barite-S}$
2.  $\% \text{Pb} \times (32.07/207.2) = \% \text{Anglesite-S}$

Further assessment of the % barite-S and anglesite-S will be required if their maximum potential amounts are a significant portion of the calculated % sulphide-S. This will only occur if the % sulphide-S is low or the concentrations of total barium and lead are high. More accurate estimates of the % barite and anglesite may require the use of sub-microscopic techniques, such as Electron Microprobe, to determine the proportions of total barium and lead that occur as acid insoluble sulphate compared to other minerals. Lead may occur in galena and barium may occur in various silicates, oxides and carbonates. A more detailed assessment of the contribution of %

acid insoluble sulphate-S to the % sulphide-S is the work done by the Kemess mine, and described in Section 12.6.9.2.

### 10.7.5 Estimate the Type and Concentration of Non-Iron Sulphide Minerals

Another use of total solid phase elemental data is to estimate the type and maximum concentration of non-iron sulphide minerals and, as a result, the degree to which all sulphide could be more or less acid generating compared to iron sulphide (e.g. pyrite and pyrrhotite). In the calculation of the acid potential in Acid Base Accounting, it is assumed that all the sulphide-S will produce the same amount of acidity as the oxidation of iron sulphide close to near-neutral pH (Chapter 12). Iron sulphide minerals are generally present in much higher concentrations than other sulphide minerals and therefore this assumption is generally true. However, it is important to check whether a significant portion of the sulphide is in the form of non-iron minerals capable of increasing or decreasing the acidity per unit of S.

A coarse estimate of the levels of non-iron sulphide minerals can be made by assuming the total concentration of the corresponding elements occur as sulphides. In reality, the identity of the sulphide minerals will ideally come from the mineralogical data (Chapter 17).

Some sample calculations for converting elemental concentrations to the concentration of sulphide-S, assuming the entire concentration is in that sulphide mineral, is provided below. Note that these calculations assume ideal mineral formulas, which do not apply fully to most mine sites.

Covellite and Cu Sulphide Fraction of Chalcopyrite (1 Cu : 1 S):

$$\% \text{ Cu} \times 32.07/63.54 = \% \text{ Cu-S}$$

Cu in Chalcocite ( $\text{Cu}_2\text{S}$ ):

$$\% \text{ Cu} \times 32.07/(2 \times 63.54) = \% \text{ Cu-S}$$

Molybdenite:  $\% \text{ Mo} \times (2 \times 32.07)/95.94 = \% \text{ Mo-S}$

Pentlandite:  $\% \text{ Ni} \times 32.07/58.7 = \% \text{ Ni-S}$

Galena:  $\% \text{ Pb} \times 32.07/207.2 = \% \text{ Pb-S}$

Sphalerite:  $\% \text{ Zn} \times 32.07/65.38 = \% \text{ Zn-S}$

When the approximate estimate indicates that potentially more or less acid generating sulphide-S may significantly alter the magnitude of the Acid Potential and NPR, a more detailed assessment should be conducted of the sulphide minerals, the proportion of the trace elements in non-sulphide minerals and acid generation by the reaction products.

### 10.7.6 Identification of Anomalous Geochemical Conditions

Total solid phase elemental data can be used to identify materials with an anomalous geochemical composition that may impact drainage chemistry. For example, low concentrations of Ca and Mg may indicate materials with very low levels of neutralizing capacity (Chapter 13), a situation where even very low sulphide concentrations may result in acidic drainage and higher sulphide concentrations may result in the rapid onset of acidic drainage. Low concentrations or anomalous ratios between nutrients (e.g.  $\text{Mg} > \text{Ca}$ ) may indicate challenges for plant growth.

## 10.8 Detection Limits

Table 10.1 provides current examples of the elements measured, the minimum and maximum detection limits and the current costs for different total, near total and partial solid phase elemental methods. Detection limits differ for different elements. The detection limits and the elements may vary over time and between laboratories due to differences in the techniques, the standards used to calibrate individual instruments and the statistical method used to calculate the detection limit. Detection limits may also vary between samples and sample sets due to differences in composition. For example, dilution required as a result of high concentrations of some elements may increase the minimum detection limits for other elements. The detection limits may also vary due to interferences in the sample.

Methods may vary slightly between laboratories due to differences in the instruments and differences in sample preparation, analysis and QA/QC procedures which have been developed over years of performing the analyses. For example, one manufacturer may suggest operational methods and sample preparation techniques which are different from another instrument manufacturer. As with all analyses, accuracy requires careful calibration with a range of appropriate standards. Likewise, analytical precision requires that the techniques used are consistent between samples and between laboratory personnel.

## 10.9 Recommended Methods

When selecting a method, it is important to consider the purpose of the data and limitations of

*It is important when selecting a method to consider the purpose for the data and limitations of the technique and ensure the selected method or methods provides the required elemental analyses and accuracy, and is compatible with the materials being investigated.*

the technique and ensure the selected method or methods provides the required elemental analyses and accuracy and is compatible with the materials being investigated. Discussions with the testing laboratory should be conducted to ensure an

appropriate method is selected based on these considerations. The methods of digestion and analysis should always be reported when using and communicating results, so reviewers are aware of the potential limitations of the information.

Due to cost and ability to provide the necessary level of accuracy and detection limits, the most commonly used methods are wet acid digestion, such as four acid and aqua regia, followed by ICP-AES. Four acid digestion is slightly more expensive to conduct than aqua regia but provides a more complete sample digestion. In most situations, the objective is to identify anomalously high elemental concentrations and thus the lower minimum detection limits provided by ICP-MS are often not required.

Where the objective is to determine the concentration of major mineral forming cations or the total elemental composition of the whole rock, digestion by lithium borate fusion with analysis by XRF or ICP-AES is recommended. Sodium peroxide fusion rather than lithium borate fusion is recommended when the sulphide mineral concentration is > 5%.

**Table 10.1 Examples of detection limits and costs for total solid phase elemental analysis.**

Digest Analysis	Lithium Borate	Na H <sub>2</sub> O <sub>2</sub> ICPAES	Lithium Borate ICP/MS	Pellet XRF	Aqua Regia		Four Acids	
	XRF/ICPAES				ICPMS/AES	ICP/AES	ICPMS/AES	ICP/AES
	%	%	ppm	ppm	ppm	ppm	ppm	ppm
Ag			1 - 1000		0.01 - 100	0.2 - 100	0.01 - 100	0.5 - 100
Al	0.01-100	0.01 - 30			0.01 - 15%	0.01 - 15%	0.01 - 25%	0.01 - 25%
As		0.01 - 10		5-5000	0.1 - 10,000	2 - 10,000	0.2 - 10,000	5 - 10,000
B					10 - 10,000	10 - 10,000		
Ba	0.01-100		0.5 - 10,000	10 - 10,000	10 - 10,000	10 - 10,000	10 - 10,000	10 - 10,000
Ca	0.01-100	0.01 - 30			0.01 - 15%	0.01 - 15%	0.01 - 25%	0.01 - 25%
Cd					0.01 - 500	0.5 - 500	0.02 - 500	0.5 - 500
Co		0.002 - 30	0.5 - 10,000		0.1 - 10,000	1 - 10,000	0.1 - 10,000	1 - 10,000
Cr	0.01-100	0.01 - 30	10 - 10,000		1 - 10,000	1 - 10,000	1 - 10,000	1 - 10,000
Cu		0.005 - 30	5 - 10,000	10 - 10,000	0.2 - 10,000	1 - 10,000	0.2 - 10,000	1 - 10,000
Fe	0.01-100	0.05 - 60			0.01 - 15%	0.01 - 15%	0.01 - 25%	0.01 - 25%
Hg					0.01 - 10,000	1 - 10,000		
K	0.01-100	0.1 - 30			0.01 - 10%	0.01 - 10%	0.01 - 10%	0.01 - 10%
Mg	0.01-100	0.01 - 30			0.01 - 15%	0.01 - 15%	0.01 - 15%	0.01 - 15%
Mn	0.01-100	0.01 - 30			5 - 10,000	5 - 10,000	5 - 10,000	5 - 10,000
Mo			2 - 10,000		0.05 - 10,000	1 - 10,000	0.05 - 10,000	1 - 10,000
Na	0.01-100				0.01 - 10%	0.01 - 10%	0.01 - 10%	0.01 - 10%
Ni		0.005 - 30	5 - 10,000	10 - 15,000	0.2 - 10,000	1 - 10,000	0.2 - 10,000	1 - 10,000
P	0.01-100				10 - 10,000	10 - 10,000	10 - 10,000	10 - 10,000
Pb		0.01 - 30	5 - 10,000		0.2 - 10,000	2 - 10,000	0.5 - 10,000	2 - 10,000
S		0.01 - 60			0.01 - 10%	0.01 - 10%	0.01 - 10%	0.01 - 10%
Sb					0.05 - 10,000	2 - 10,000	0.05 - 1000	5 - 10,000
Se					0.2 - 1,000		1 - 1000	
Si		0.01 - 30						
Sn			1 - 10,000	5 - 10,000	0.2 - 500		0.2 - 500	
Sr	0.01-100		0.1 - 10,000	2 - 10,000	0.2 - 10,000	1 - 10,000	0.2 - 10,000	1 - 10,000
Ti	0.01-100	0.01 - 50			0.005 - 10%	0.01 - 10%	0.005 - 10%	0.01 - 10%
U			0.5 - 1000	4 - 10,000	0.05 - 10,000	10 - 10,000	0.1 - 500	
W			1 - 10,000	10 - 10,000	0.05 - 10,000	10 - 10,000	0.1 - 10,000	10 - 10,000
Zn		0.01 - 30	5 - 10,000	10 - 10,000	2 - 10,000	2 - 10,000	2 - 10,000	2 - 10,000
Zr		0.01 - 30	0.5 - 10,000	2 - 10,000	0.5 - 500		0.5 - 500	
Cost \$	32.00	25.00	27.50	27.50	18.75	9.00	22.50	12.00

## 10.10 Recipes

### 10.10.1 Elemental Analysis

1. Use matrix matched calibration standards to correct for inter-element interference (both major and trace elements).
2. The instrument should be calibrated according to internal laboratory QA/QC procedures and the instrument Operator's Manual supplied by the manufacturer.

### 10.10.2 Lithium Tetraborate Fusion Digestion / XRF or ICP Analysis

1. A finely ground sample is mixed with lithium tetraborate flux (to lower the melting point of the mixture) and fused (heated until molten) in a furnace at approximately 1100°C.
2. The resulting melt is cooled and a thin glass disk is prepared.
3. Elemental Analysis
  - 3a. Glass disk is analyzed by XRF spectrometry.
  - 3b. Glass disk is dissolved in a known volume of 4-5% nitric acid and the resulting solution is analyzed by ICP-MS or ICP-AES.
4. Oxide concentrations are calculated from the resulting elemental concentrations so results can be reported in an oxide format.
5. To determine Loss On Ignition (LOI), approximately 1 g of sample is placed in a dry porcelain crucible, weighed, and ashed at 1000°C for about 1 hour. The sample and crucible are then cooled in a desiccator, re-weighed and the LOI calculated.

### 10.10.3 Pressed Pellet / XRF Analysis

1. A finely ground sample of about 2 g is combined with a liquid binder, compressed on a boric acid backing in an aluminum mold and dried.
2. The concentrations of trace elements in the pressed pellet are analyzed by XRF spectrometry.

### 10.10.4 Four Acid Digestion / ICP Analysis

1. A finely ground (pulped) sample is digested with a mixture of hydrofluoric, perchloric, and nitric acids.
2. The digestion is taken to near dryness.
3. A small amount of hydrochloric acid is added to further the digestion and dissolve the residue.
4. The sample is then made up to a final volume in a volumetric flask with hydrochloric acid and homogenized.
5. An exact aliquot of the sample is transferred to a clean auto sampler tube.
6. The concentrations of trace elements are analyzed by ICP-MS or ICP-AES.

### 10.10.5 Aqua Regia Digestion / ICP Analysis

1. A finely ground sample is mixed with a small known volume of aqua regia solution (concentrated HCl:HNO<sub>3</sub> - 3:1).
2. Test tubes are placed in racks in a hot water bath making sure that the water level in the pan is above the level of the sample solution. Digest at approximately 95°C for 2 hours.



3. The sample is cooled and brought up to a known volume in a volumetric flask with demineralized/deionized water. The samples are then capped, shaken and centrifuged.
4. Using a macro pipettor, an exact aliquot of the sample solution is taken and transferred to a clean autosampler tube, adding a known additional volume of demineralized/deionized water, if necessary, and shaken to mix it.
5. The concentrations of trace elements are analyzed by ICP-MS or ICP-AES.

### 10.11 Summary of Key Considerations

- Whole rock or near-total solid phase elemental analysis would be useful to perform on sulphidic geologic materials impacted by a mine.
- Whole rock and near-total solid phase elemental analysis provides limited information about the form (e.g. mineral) in which the elements exist and on its own is not a measure of the potential concentrations in drainage or the threat to the environment.
- Information on the mineralogy, geochemical conditions, rate of weathering, secondary mineral solubility and the resulting drainage chemistry would be useful to interpret the environmental significance of solid phase elemental analysis results.
- Digestion methods vary in their ability to dissolve different minerals and their susceptibility to interference by features such as the sulphide content.
  - Whole Rock Digestion → Lithium borate fusion.
  - Whole Rock Digestion, sulphide > 5% → Sodium peroxide fusion.
  - Near Total Digestion Whole Rock Digestion → Four acid.
  - Reactive Mineral Digestion → Aqua regia.
- An assessment of the sulphur content, ideally a sulphide-S analysis, would be useful to conduct in advance of solid phase elemental analysis to detect samples where elevated sulphide may interfere with the analysis.
- Report methods of digestion and analysis and detection limits, when using and communicating results, so others are aware of the potential limitations of the data.

### 10.12 References

Guerin, F., S. Wilson and R. Nicholson. 2006. Optimizing In-Pit Disposal of Problematic Waste Rock Using Leaching Tests, Portable XRF, Block and Mass Transport Models. In: Proceedings of 13th British Columbia - MEND Metal Leaching/Acid Rock Drainage Workshop, Challenges with Open Pits and Underground Workings. Vancouver, British Columbia, November 29-30.



## 11.0 ANALYSIS OF SOLUBLE CONSTITUENTS

### *Some Important Points in this Chapter*

*Sulphidic geologic materials are often comprised of suites of minerals whose solubilities range from relatively low to high. The more soluble minerals can often dissolve faster and thus determine immediate drainage chemistry. However, the chemistry of the local water, the contact (residence) time and the water:solid ratio can also affect the dissolution of soluble constituents. The recommended procedure for measuring soluble constituents is to add the sample to shake flasks, with a default ratio of 3 parts solid to 1 part water on a weight basis and gently agitate it for 24 hours. These test conditions can be changed as needed to address site specific prediction questions. Attaining equilibrium, including mineral solubility limits, is important because net dissolution stops and aqueous concentrations do not rise any higher.*

*Therefore, an important aspect in testing for soluble constituents is identifying when equilibrium has been reached. As a check for whether equilibrium limits have been attained, a sample can be leached a second time with fresh leach water or at different water to solids ratios. As a check for whether residence time has affected the results, leaching of the solid residue can be extended or repeated for a longer time. The measurements of surface (rinse), crushed and paste (pulverized) pH also reflect soluble constituents of samples.*

### 11.1 Introduction

Sulphidic geologic materials are often composed of suites of minerals whose solubilities range

*The more soluble minerals can often dissolve faster and thus determine immediate drainage chemistry.*

from relatively low to high. Oxidation and weathering can create even more soluble, secondary minerals. The more soluble minerals can often dissolve faster and thus determine immediate drainage chemistry.

#### 11.1.1 Soluble Constituents

The source, dissolution rate and total mass of soluble constituents and the resulting drainage chemistry, are a function of the:

- solubility of the solid phase constituents; and
- capacity of the water to dissolve solutes.

The solubility of solid constituents depends on the properties of their composition such as mineralogy and speciation. Sulphides and most primary rock forming minerals are relatively insoluble under ambient surface conditions, unless altered into another more soluble chemical form by weathering and oxidation. Possible exceptions are some relatively soluble arsenic and antimony sulphides. In contrast to most sulphides and primary rock forming minerals, carbonates, sulphates and hydroxides produced by aerial weathering and hydrothermal processes are relatively soluble.

The capacity of drainage to dissolve solid phase constituents can depend on various factors such as the:

- chemistry of the drainage;
- solubility limits;
- ratio of water to solid; and
- residence time.

Drainage properties that can control solubility include pH, Eh, temperature and the presence of organic acids. For example, the solubilities of Cu, Hg and some other metals can be raised by high concentrations of organic acids. Also, the solubilities of many metals and other elements increase with a decrease in pH from near neutral to acidic levels, although exceptions like molybdenum can have a lower solubility at an acidic pH. At a near-neutral pH, a reduction in Eh may convert insoluble ferric iron hydroxides into soluble ferrous iron, increasing the solubility of co-precipitated trace elements such as arsenic.

*Drainage properties that can control solubility include pH, Eh, temperature and the presence of organic acids.*

The chemistry of the drainage will be a function of both the chemistry of the drainage inputs and the soluble constituents in the materials being leached.

Once contaminant concentrations reach chemical equilibrium net dissolution stops and aqueous concentrations do not rise any higher. Equilibrium may reflect mineral solubility limits and thus, the value of equilibrium mineral solubility limits may be very good in predicting maximum concentrations and loadings. However, equilibrium can be the result of processes other than mineral solubility, including metastable and site specific equilibrium, dynamic equilibrium, pseudo-equilibrium, and emergence.

Factors that will reduce the likelihood of reaching equilibrium mineral solubility limits include:

- a relatively high water to solids ratio;
- short residence time if the rate of dissolution is relatively slow; and
- drainage chemistry that increases the equilibrium mineral solubility limits.

Surface runoff and stream flow through the base of a waste rock dump may have a relatively high water to solids ratios and a relatively short residence time. During deposition, wastes placed underwater in a flooded impoundment may also have a relatively high water to solids ratio. Drainage infiltrating slowly through high waste rock dumps and deep tailings will eventually have both a relatively low water to solid ratio and a long residence time along flow paths.

### 11.1.2 Measurement Objectives

The objectives when measuring soluble constituents are to predict the following:

- future drainage chemistry when leaching starts;
- future drainage chemistry if there are changes in the drainage volume or chemistry;
- concentrations of less soluble constituents;
- potentially soluble constituents in different chemical phases;

- depletion of neutralizing minerals; and
- site specific equilibrium limits.

Properties of drainage chemistry of key interest for sulphidic geologic materials are: pH, Eh, the concentrations and loadings of trace elements, sulphate, acidity and alkalinity concentrations. Measurement can be used to predict the effect of changes in parameters such as climate, pH and Eh. Prediction of the concentration of non-soluble constituents includes the use of measurements of acid leachable sulphate-sulphur to calculate the % sulphide-sulphur (Section 12.6.3). Measurement of the potentially soluble constituents in different chemical phases with analyses such as sequential extractions can be used to predict contaminant release for different weathering and leaching conditions. Measurement of maximum loadings and solubility constraints are useful in the prediction of drainage chemistry because they set an upper limit on contaminant discharge.

### 11.1.3 When to Analyze Soluble Constituents

The frequency, location and procedures to use in analyzing for soluble constituents will depend on the:

- prediction questions;
- properties of the materials;
- existing information;
- timing of management actions and regulatory decisions (Section 3.17);
- variability of the targeted properties and processes; and
- accuracy and precision required of the prediction.

There is an increased potential for the environmentally significant dissolution of soluble constituents and more frequent analysis may be required for constituents under the following circumstances:

- an unusual geochemistry (e.g. soluble antimony sulphides);
- exposure of weathered materials to increased leaching:
  - increased drainage inputs,
  - excavation of oxidized or supergene enriched bedrock,
  - disturbance of historic mine wastes, and
  - aerial weathering during delay prior to flooding of mine wastes.
- change in drainage chemistry:
  - onset of acidic conditions, and
  - onset of strongly reducing conditions.

Descriptions of geologic materials (Chapter 6), acid soluble sulphate analysis (Chapter 12) and petrographic examinations (Chapter 17) may be used to identify geologic materials where weathering and hydrothermal processes may have resulted in significant concentrations of soluble constituents.

### 11.1.4 Measurements of Soluble Constituents

Measurements of soluble constituents can be made by analyzing:

- pore water within the project component;
- drainage discharged from the project component; and
- solutions created by adding a solvent to a sample of the material under investigation.

Chemical analyses of the pore water and drainage discharged from project components will provide site specific information about the presently soluble constituents, the resulting drainage chemistry and solubility limits. Analyses of these waters can also be used to check previous predictions and to track temporal changes in drainage chemistry.

One limitation in the analyses of pore water and drainage is that the present drainage chemistry may not indicate the concentrations of constituents if the volume of drainage or the chemistry changes. Another limitation is that the source of pore water and discharge may be poorly defined or from a composite of materials, so that it is not clear to which geologic materials or components the soluble constituents correspond.

*One limitation in the analyses of pore water and drainage are that the present drainage chemistry may not indicate the concentrations of constituents if the volume of drainage or the chemistry changes.*

Analysis of solutions created by adding a solvent to samples can be used to predict:

- contaminant concentrations and loadings from specific geologic materials and project components under variable chemistry and volume of drainage;
- concentration of residual, insoluble constituents;
- chemical forms of potentially soluble constituents; and
- depletion of neutralizing minerals.

## 11.2 Analytical Methods for Soluble Constituents

Unlike analyses that have strict methodologies to follow, the methods for the analysis of soluble constituents in a sample should be modified to fit the prediction objectives, the sample, and the soluble constituents. A range of test conditions, such as a series of different water to solids ratios, may be part of the procedure for measuring parameters, such as equilibrium mineral solubility limits.

*Unlike analyses that have strict methodologies to follow, the methods for the analysis of soluble constituents in a sample should be modified to fit the prediction objectives, the sample and the soluble constituents.*

Test conditions that may vary in the analysis of soluble constituents include the following:

- pretreatment of the sample;
- particle size analysis;
- water to solids ratio;
- chemistry of the drainage;
- residence time;

- number of repetitions;
- degree of agitation; and
- method of analysis.

Where the objective is to predict field performance, key test conditions should match conditions in the field. Differences from field conditions may occur due to:

- logistical limitations, such as a lack of site drainage to use as leach water; and
- analytical requirements, such as having enough leach water to analyze.

A detailed description of the analytical materials and methods should accompany the extraction data and differences between test and field conditions should be considered in the interpretation of the results.

### **11.2.1 Pretreatment and Particle Size to Use in the Analysis**

Pretreatment and the selection of material to analyze, including whether to pulverize (crush and grind) samples and which fraction of the particle size to analyze, will depend on the type of material and the properties being measured.

Analysis can be conducted on pulverized material where:

- the objective is to measure some aspect of the total composition, such as acid leachable sulphate-sulphur, and surface exposure is not important; or
- the test material is lithified material such as drill core or blast hole cuttings and crushing and grinding are required to expose potentially soluble constituents to the drainage.

Crushing and grinding samples may increase dissolution of some soluble constituents and change the drainage chemistry by:

- increasing the mineral surface area;
- damaging mineral grains and surfaces;
- exposing previously occluded and therefore unweathered constituents; and
- raising the drainage pH and reducing the solubility of most metals by increasing the dissolution of neutralizing minerals.

Therefore, non-lithified test material should not be pulverized if the objective is to measure the impact of either the previous surface weathering or the present mineral surface exposure on soluble constituents and drainage chemistry.

The analysis of soluble constituents and drainage chemistry of fine textured materials, such as tailings or pulverized samples, can be conducted on a sub-sample of the total sample. The analysis of materials containing coarse fragments, such as till and waste rock, should be conducted on a sub-sample of the size fraction that is representative of the reactive material.

Advantages and disadvantages with using the < 2 mm fraction to represent the reactive fraction are noted in Chapter 8. One advantage, in addition to those noted in that chapter, is that a

smaller sample (50 to 100 g) and therefore smaller containers and apparatus, such as shake tables, can be used for a sample of the < 2 mm size fraction.

### 11.2.2 Leach Water to Use in the Analysis

Properties that may vary in the analysis of soluble constituents include the:

- chemistry;
- ratio of the volume to the mass of the solid; and
- residence time.

Another modification is to use gentle agitation to ensure complete mixing of the sample and water. Care should be taken in agitating the sample to minimize particle abrasion and breakage.

The drainage properties selected for the analysis will depend on the type of material, leaching conditions, the prediction questions and the water available for use.

### 11.3 Leach Water Chemistry

The capacity of water to dissolve soluble constituents will depend on its chemistry. In turn, the chemistry of the water will depend on the composition of the inflowing or added water and the solute inputs from the material being leached. Therefore, actual site drainage is the optimum leach water for the analysis if the objective is to measure soluble constituents under existing conditions.

*Actual site drainage is the optimum leach water for the analysis if the objective is to measure soluble constituents under existing conditions.*

The use of site drainage may not be possible for various reasons, including a lack of process water prior to mining or drainage sources are not available in large enough quantities. Alternative water sources must be used if real drainage is not available. Distilled or deionized water can be used as the initial drainage in the analysis if:

- initial drainage is expected to be this dilute; or
- properties of the drainage primarily result from the material being leached rather than from the input water.

Also, water with a synthetic chemistry through the addition of chemicals, similar in composition to the actual drainage, can be used if the composition of the initial drainage plays a major role in determining the soluble constituents.

Artificial drainage chemistries may also be required where the objectives of the analysis of soluble constituents are to measure:

- specific chemical species and concentrations of insoluble constituents (e.g. measurement of acid leachable sulphate-sulphur for use in calculation of sulphate and sulphide-sulphur, Chapter 12);
- potentially soluble constituents in different chemical phases (e.g. sequential extraction methods); and
- contaminant concentrations and drainage chemistry if there is a future change in chemistry.



Analyses may be conducted at a variety of pH values to measure the influence of differences where there is uncertainty about the future drainage pH.

An important consideration when measuring the impact of a change in water chemistry on contaminant concentrations and loading is that dissolution of the test material itself may change the water chemistry from the intended test conditions. For example, samples with significant calcium carbonate will rapidly neutralize weak acid solutions resulting in a near-neutral drainage pH. An auto-titrator can be used to maintain the desired drainage pH where the objective is to measure contaminant dissolution at a specified drainage pH. All analyses of soluble constituents should include parameters, such as pH and alkalinity, in the final analysis to confirm final leaching conditions and to enable equilibrium mineral solubility modeling.

*Dissolution of the test material itself may change the water chemistry from the intended test conditions.*

### 11.3.1 Weight of Sample and Ratio of Water to Solid Phase

The chosen weight of sample and the water to solids ratio will depend on the:

- prediction questions;
- type of material and leaching conditions being tested;
- measurement requirements; and
- available sample and laboratory equipment.

A larger sample size will be required to create a representative test material from material with a larger particle or grain size. However, due to sampling and laboratory size constraints, analyses of waste rock are usually conducted on the < 6.4 mm or < 2 mm particle size fractions. Particle size restrictions will also reduce autogenous grinding by the coarser fragments if the analysis includes shaking the sample. A larger sample size usually means that a lower number of samples can be analyzed at one time, raising analysis costs.

A high water to solids ratio that simulates the absence of equilibrium solubility limits will be needed to measure maximum potential contaminant loadings during the deposition of wastes underwater in a flooded impoundment. A relatively low water to solids ratio will be required if the objective is to measure equilibrium limits in drainage infiltrating through high waste rock dumps and deep tailings.

As a check for whether equilibrium limits have been attained, a sample can be leached again with fresh leach water or at different water to solids ratios. As a check for whether residence time has affected results, leaching of the solid residue can be extended or repeated for a longer time.

Logistical considerations in the water to solids ratio include:

- size of the available laboratory equipment; and
- recovering enough water to analyze.

Smaller sample sizes may allow higher water to solids ratios, but smaller sample sizes may make it more difficult to create a representative sub-sample and aqueous concentrations may fall below

detection limits. A higher ratio of water to solid in the test than in the actual project component may:

- excessively dilute solute concentrations producing much lower concentrations than found in the component, and
- fail to identify equilibrium mineral solubility limits.

There is a continuum of different possible water to solids ratios. Examples include the following:

- 1:2 – traditional paste pH analysis;
- 1:1 – pH analysis; and
- 3:1 – shake flask analysis.

#### 11.4 Pre-Test Characterization of the Solid Phase Test Material

Detailed pre-test characterization of the test material is required to:

- check that samples are representative of the properties that need to be tested and the portion of the project component that is a concern;
- indicate properties such as surface area and concentration of minerals to which results apply;
- identify mineral sources for different chemical species in the leach water; and
- in conjunction with results from post test characterization, provide a check on results of other forms of monitoring and measure the amount and type of precipitation and dissolution of weathering products.

The analyses should consist of the following:

- total elemental analysis;
- sulphur species, including sulphide and total sulphur;
- bulk and carbonate based neutralization potential;
- particle size analyses; and
- petrographic and X-ray Diffraction mineralogical determinations.

Other forms of analysis, such as SEM/EDS or Microprobe, may be needed depending on pre-test results.

#### 11.5 Shake Flask Test

A shake flask test is the recommended solubility test procedure for determining the mass of soluble constituents (mg/kg) at higher water to solids ratios. The recommended procedure is for the sample to be shaken for 24 hours, at a 3:1 water to solids ratio by weight, although this procedure can be changed as appropriate.

*The recommended procedure is for the sample to be shaken for 24 hours, at a 3:1 water to solids ratio by weight, although this procedure can be changed as appropriate.*

Mineral solubility and other equilibrium determinations should be conducted on the analytical

results. Gentle agitation is provided to ensure continuous exposure of all surfaces and mixing of the rinse solution. Twenty-four hours is a nominal residence time.

The 3:1 ratio was selected to minimize:

- attainment of equilibrium limits,
- excessive dilution resulting in low concentrations and detection limits for important contaminants, and
- large sample sizes that increase analysis costs.

Unless the appropriate site drainage is available, the recommended procedure is to use distilled or deionized water as the leach water.

1. Detailed pre-test characterization of the test material (Section 11.3).
2. Weigh a representative 100 g of minus 6.35 mm (- ¼ inch) sub-sample and place it into a cleaned 500 mL container. Add 300 mL of distilled or deionized water of known chemical composition, as defined through chemical analysis, to the container. The ratio of 3:1 can also be achieved with other sample weights, similarly changing the volume of distilled or deionized water and the container. For a 250 g sub-sample, use 750 mL of distilled or deionized water and a cleaned 1000 mL container.
3. Gently agitate the samples on a shake table or gyratory shaker for 24 hours. The use of a shake table is to ensure complete contact of the sample with the water. The agitation should be gentle and not result in comminution of the sample material. End-over-end rotation may break particles and is not recommended. On completion of the 24 hour agitation, let the samples stand for a minimum of three hours, allowing suspended materials to settle.
4. Collect the supernatant waters, recording their volumes. Measure the pH of sub-samples and then immediately process the waters (i.e. filter, preserve, etc.) and submit for multi-element chemical analysis. Dissolved parameters are important to determine readily soluble components. Return any solids collected on the filters back to the original containers.
5. Transfer the wet solids from the containers to pre-weighed drying trays, ensuring the entire sample has been removed.
6. Air dry the wet samples, or dry in an oven on low heat (< 40°C) if necessary. If the samples were dried in an oven, cool in a desiccator prior to weighing. Record the final weights of the dry samples.
7. If detailed post-test characterization or additional analysis of soluble constituents of the test materials is required, take representative splits from the samples and submit them for analysis.

#### Additional Analyses

- a. As a check for whether equilibrium limits have been attained, a sample can be leached again with fresh leach water or at different water to solids ratios.
- b. As a check for whether residence time has affected the results, leaching of the solid residue can be extended or repeated for a longer time.

## 11.6 pH Analysis

pH is a measure of the hydrogen ion activity of a solution, typically made with a combination pH electrode inserted in a test solution. Uses for pH analysis include:

- estimating weathering and leaching conditions; and
- detecting samples with no reactive neutralizing minerals or a surplus of acidic soluble constituents.

pH is a principal factor in both primary mineral reaction rates and secondary mineral solubility

*pH is a principal factor in both primary mineral reaction rates and secondary mineral solubility and therefore can have a large effect on drainage chemistry.*

and therefore can have a large effect on drainage chemistry. For example, increases in the concentration of trace metals such as Cu and Mo are often linked to pH changes with Cu solubility increasing and Mo solubility decreasing as the pH becomes acidic. The pH

along with sulphur species (Chapter 12) and neutralization potential (Chapters 13 and 14) are a part of Acid Base Accounting (Chapter 14).

Solid sample pH values measured by most laboratories are reported as a paste pH and are measurements made on the mixtures of water and pulverized sample. The main error in pH analyses is that weathered samples should not be pulverized if surface, or rinse, pH is the objective.

### 11.6.1 Abrasion pH

The pH of rock and overburden crushed underwater is called the abrasion pH; underwater crushing is used to dissipate any heat that may be produced. The results have been used as an indicator of mineralogy and previous weathering (Clarke, 1900; Stevens and Carron, 1948; Grant, 1969; Ferrari and Magaldi, 1983). The effect of crushing intensity on the quantity of ions released and the resulting pH is also documented in the literature (Grant, 1969).

Although the data results from a slightly different procedure (underwater crushing) than paste pH, the abrasion pH data provided by Stevens and Carron (1948) indicates the pH of various crushed minerals (Table 11.1).

**Table 11.1 Field test for minerals by abrasion pH (taken from Stevens and Carron, 1948).**

Mineral	Composition		Abrasion pH														
	Formula	Type <sup>1</sup>	Acidic						N*	Alkaline							
			1	2	3	4	5	6		7	8	9	10	11	12		
Coquimbite	Fe <sub>2</sub> (SO <sub>4</sub> ) <sub>3</sub> ·9H <sub>2</sub> O	b A															
Alunogen	Al <sub>2</sub> (SO <sub>4</sub> ) <sub>3</sub> ·16H <sub>2</sub> O	b A															
Pickeringite	MgAl <sub>2</sub> (SO <sub>4</sub> ) <sub>4</sub> ·22H <sub>2</sub> O	B b A															
Potash Alum	KAl(SO <sub>4</sub> ) <sub>2</sub> ·12H <sub>2</sub> O	B b A															
Aluminite	Al <sub>2</sub> SO <sub>4</sub> ·9H <sub>2</sub> O	b A															
Scorodite	FeAsO <sub>4</sub> ·2H <sub>2</sub> O	b A															
Sessolite	H <sub>3</sub> BO <sub>3</sub>	a															
Jarosite	K <sub>2</sub> Fe <sub>6</sub> (OH) <sub>12</sub> (SO <sub>4</sub> ) <sub>4</sub>	b a															
Siderite	FeCO <sub>3</sub>	b a															
Gypsum	CaSO <sub>4</sub> ·2H <sub>2</sub> O	B a															
Pyrophyllite	Al <sub>2</sub> Si <sub>4</sub> O <sub>10</sub> (OH) <sub>2</sub>	b a															
Quartz	SiO <sub>2</sub>	a															
Gibbsite	Al(OH) <sub>3</sub>	b															
Andalusite	Al <sub>2</sub> SiO <sub>5</sub>	b a															
Muscovite	KAl <sub>3</sub> Si <sub>3</sub> O <sub>10</sub> (OH) <sub>2</sub>	B b a															
Calcite	CaCO <sub>3</sub>	B a															
Anorthite	CaAl <sub>2</sub> Si <sub>2</sub> O <sub>8</sub>	B b a															
Microcline	KAlSi <sub>3</sub> O <sub>8</sub>	B b a															
Talc	Mg <sub>3</sub> Si <sub>4</sub> O <sub>10</sub> (OH) <sub>2</sub>	B a															
Albite	NaAlSi <sub>3</sub> O <sub>8</sub>	B b a															
Dolomite	CaMg(CO <sub>3</sub> ) <sub>2</sub>	B B a															
Borax	Na <sub>2</sub> B <sub>4</sub> O <sub>7</sub> ·10H <sub>2</sub> O	B a															
Phlogopite	KMg <sub>3</sub> AlSi <sub>3</sub> O <sub>10</sub> (OH) <sub>2</sub>	B B b a															
Magnesite	MgCO <sub>3</sub>	B a															
Brucite	Mg(OH) <sub>2</sub>	B															
Merwinite	Ca <sub>3</sub> Mg(SiO <sub>4</sub> ) <sub>2</sub>	B B a															
Shertite	Na <sub>2</sub> Ca <sub>2</sub> (CO <sub>3</sub> ) <sub>3</sub>	B B a															

<sup>1</sup> A = strong acid B = strong base a = weak acid b = weak base N\* = Neutral

### 11.6.2 Methods of Sample Preparation

The pH measurement for a solid material like waste rock is made on the associated solution and is strongly affected by the quantity and quality of the soluble constituents. Soluble constituents depend on the surface quantity and quality. The pH may be drastically altered by the method of sample preparation and therefore the reporting of test results should specify sample preparation procedures.

Two types of sample preparations that may be used prior to pH measurements include:

- pulverizing the sample (crushed sample or paste pH); and
- no particle size reduction (a surface rinse pH).

### 11.6.2.1 Crushed Sample pH

Pulverizing the sample is a necessity when the analysis is carried out on drill core, large rock fragments, bedrock or other lithified materials or if the material, like rock chips from a mine wall, do not contain fine sized material. A sample is typically pulverized to 100  $\mu\text{m}$  size or smaller. The pH of pulverized samples varies according to the degree of weathering, particle size, the effects of mineral abrasion and the residual alkalinity. Where the composition of particle surfaces and the interior of particles are the same, pulverizing will have little impact on the measured pH.

The potential problem with pulverizing a sample is that it creates new surfaces and for weathered

*The potential problem with pulverizing a sample is that it creates new surfaces and for weathered samples, exposes and abrades minerals previously occluded from weathering.*

samples exposes and abrades minerals previously occluded from weathering. The newly exposed mineral surface area can potentially have a large effect on drainage properties such as pH.

Data from a number of British Columbia mine sites show that for the same weathered waste rock sample, the 1:1 solid:water pH of the pulverized > 19 mm particle size fraction (crushed sample pH) may be three to four units higher than of the uncrushed < 2 mm particle size fraction (surface rinse pH) (Price and Kwong, 1997).

### 11.6.2.2 Surface Rinse pH

The surface rinse pH should be conducted on a dry sieve sorted < 2 mm particle size fraction with no particle comminution. The < 2 mm particle size fraction is considered to be representative of the finer particles, which due to their disproportionately greater particle surface area will determine the pore water chemistry. A surface rinse pH should be conducted on all weathered, non-lithified samples. pH determinations on pulverized samples may also be conducted on weathered samples, if additional information is required on properties like the residual alkalinity within the particles.

## 11.6.3 Electrode Measurement of pH

The recommended procedure is to measure the pH with a glass electrode and meter.

Care must be taken to ensure electrode life and accurate pH measurements:

1. The electrode should not remain in the sample longer than necessary for a reading, especially if it is more alkaline than pH 9.0 *or more acidic than pH 2.0*.
2. The electrode should be washed with a jet of distilled water from a wash bottle after every measurement in a sample or buffer solution.
3. The electrode should be dipped in dilute (0.1 N) hydrochloric acid for a few seconds and washed with distilled water to remove any calcium carbonate film which may form, especially from alkaline samples.
4. The electrode should not be permitted to dry out.
5. The electrode should be cleaned and suspended in distilled water, which is protected from evaporation, for short term storage.
6. The pH meter should be placed in standby position when the electrode is not in a solution.

The pH meter and electrode should be standardized with buffers differing by 3 or 4 pH units, such as 7.0 and 4.0, before beginning a series of measurements. After every tenth measurement, standardization should be verified with both buffers. Care should be taken not to contaminate one buffer solution with the other buffer solution or with the test solution. Standard buffers should never be returned to their stock bottles.

Due to various limitations, pH values usually cannot be detected to an accuracy of more than 0.2 to 0.5 pH units.

#### 11.6.4 Near-Saturation Paste pH Analysis (1:2 solution to solid weight ratio)

The term “paste pH” originally referred to a measurement made by inserting a combination

*The term “paste pH” originally referred to a measurement made by inserting a combination electrode into a paste of the < 250 µm particle-size fraction at “near saturation conditions”.*

electrode into a paste of the < 250 µm particle size fraction at “near saturation conditions” (Sobek et al., 1978; Page et al., 1982). A 1:2 water to solid weight ratio was used by default to create near

saturation conditions that match the pore water chemistry and solution to solid weight ratio during a leaching event. The objective was to create a paste where water would not pond on the surface or the material would appear dry (Sobek et al., 1978). The precise water to solid weight ratio to create near saturation conditions will vary depending on material properties such as the particle size and organic content.

The term “paste pH” is often used for a variety of pH analyses including those termed here as crushed pH and rinse pH. To avoid confusion, it is recommended that the terms traditional paste pH, crushed pH and rinse pH be adopted for different pH analyses described here.

The main advantage of the traditional paste pH procedure is that the analyzed solution more closely resembles the water to solid ratio of pore water in wastes than other analysis procedures.

Disadvantages with the traditional paste pH procedure include the following.

- If the paste is not thoroughly mixed, the procedure of inserting a combination pH electrode into the paste may put the electrode and water in contact with a limited number of particles. If the chemistry of the particles is not uniform, the resulting pH measurement may not be reproducible and may not reflect the pH of the entire sample.
- In stoney materials, there may be insufficient < 250 µm material after crushing for a valid paste pH measurement.
- The rough and angular particles produced by blasting, crushing and grinding may scratch the electrode.
- Water volumes may vary from the recommended 2:1 solid:water ratio.

### 11.6.5 1:1 Surface Rinse and Crushed Sample pH Analysis (1:1 water to solid weight ratio)

A water:solid ratio of 1:1 allows the electrode to be immersed in and a measurement to be taken of the pH of the overlying supernatant without contacting the charged solid particles.

#### Chemicals (from Sobek et al., 1978)

1. Standard buffer solutions, pH 4.00 and pH 7.00.
2. Distilled water (H<sub>2</sub>O).

#### Materials (from Sobek et al., 1978)

1. pH meter equipped with combination electrode.
2. Paper cups, 30 mL capacity.
3. Plastic cups.
4. Stirring rod.
5. Wash bottle containing distilled water.
6. Balance, can be read to 0.1 g.

#### Procedure (1:1 Solid:Solution Ratio)

1. Turn on the pH meter and adjust the temperature setting and “zero” the pH meter as per the instruction manual.
2. Place pH 4.0 and pH 7.0 standard buffers in two plastic cups (one buffer in each cup). Note: NEVER return used buffers to stock bottles.
3. Place the electrode in the pH 7.0 buffer.
4. Adjust the pH meter to read 7.0.
5. Remove the electrode from the buffer solution and wash it with a jet of distilled water from a wash bottle.
6. Place the electrode in the pH 4.0 buffer and check the pH reading. Note: If the pH meter varies more than  $\pm 0.1$  pH units from 4.0, something is wrong with the pH meter, electrode or buffers.

#### Note: the following is adapted from Page et al. (1982)

7. Weigh or measure 20 g of air-dry test material and 20 mL of distilled water.
8. Mix thoroughly for 5 sec, preferably with a portable mechanical stirrer.
9. Let the solution stand for 10 min.
10. Insert the electrode into the container and stir the supernatant by swirling the electrode slightly. Protect the electrode by taking care not to contact it with settled particles, move the electrode carefully about to insure removal of water film around the electrode. Note: Electrodes are easily scratched.
11. When the reading remains constant, record the pH and remove the electrode from the supernatant. Carefully wash the electrode with distilled water. When all the pH measurements are completed, the electrode should be stored in a beaker of distilled water. Note: After every 10 samples, check the calibration of the meter with standard buffers.



## 11.7 Conclusions

The methods used to analyze soluble constituents should be modified to fit the prediction objectives, the material being tested and the soluble constituents. A range of test conditions may be part of the recommended procedure. Where the objective is to predict field performance, test conditions should match key conditions in the field. Traditional analytical procedures, such as leaching with acetic acid, should be dropped if they have no relevance to field conditions.

Detailed characterization prior to analysis is needed to:

- ensure the properties of the tested samples are representative of the conditions;
- allow extrapolation of the results to the materials of concern; and
- identify mineral sources for soluble constituents measured in the analysis.

Pulverizing samples prior to leaching may have a major impact on the soluble constituents. While it is usually acceptable to pulverize unweathered samples, pulverizing weathered samples may expose previously occluded minerals and change the drainage chemistry and should be avoided if the objective is to measure the surface pH.

The ratio of water to solid in most analyses of soluble constituents is higher than would be present in large waste rock dumps, as well, deep tailings could produce lower contaminant concentrations and mask solubility constraints. Differences between the ratios of water to solid in the test and under field conditions should be considered in the interpretation of analytical results.

This analysis measures existing soluble constituents and cannot predict the mass of soluble constituents from future weathering reactions such as sulphide oxidation. Kinetic tests are needed to measure loadings and concentrations of soluble constituents that depend on the future weathering which may change the minerals into a more soluble form (Chapters 18 and 19).

## 11.8 References

Clarke, F.W. 1900. Alkaline Reaction of Some Natural Silicates. U.S. Geological Survey Bull. 167: 156-158.

Ferrari, G.A. and D. Magaldi. 1983. Degree of Soil Weathering as Determined by Abrasion pH: Applications. Soil Study and in Paleopedology. *Pedologie*. 33(2): 93-104.

Grant, W.M. 1969. Abrasion pH, an Index of Chemical Weathering. *Clay and Clay Minerals*, 17: 151-155.

Page, A.L., R.H. Miller and D.R. Keeney. 1982. Methods of Soil Analysis. Part 2 - Chemical and Microbiological Properties. American Society of Agronomy Inc., Soil Science Society of America Inc. Second Edition. pp. 199-209.

Price, W.A. and Y.T.J Kwong. 1997. Guidelines for the Prediction of Acid Rock Drainage and Metal Leaching for Mines in British Columbia. Part III. Waste Rock Weathering, Sampling and Analysis: Observations from the British Columbia Ministry of Employment and Investment Database. In: Proceedings of the Fourth International Conference on Acid Rock Drainage, Vancouver, British Columbia, May 31 - June 6, 1997. Vol 1: 31-45.

Sobek, A.A., W.A. Schuller, J.R. Freeman and R.M. Smith. 1978. Field and Laboratory Methods Applicable to Overburdens and Minesoils. Report EPA-600/2-78-054, U.S. National Technical Information Report PB-280 495.

Stevens, R.E. and M.K. Carron. 1948. Simple Field Test for Distinguishing Minerals by Abrasion pH. American Mineralogist. 33: 31-39.

## 12.0 SULPHUR SPECIES AND ACID GENERATION POTENTIAL (AP)

### *Some Important Points in this Chapter*

*Sulphur species are the primary source of acid, acidity and potentially deleterious elemental species in the drainage from sulphidic geologic materials. Their effects on drainage chemistry depend on factors like abundance, oxidation state, impurities, physical properties and local environmental conditions. The main sulphur minerals and species are sulphides, sulphosalts, sulphates, organic sulphur and species of intermediate oxidation states. Sulphide primarily occurs combined with iron in minerals such as pyrite, pyrrhotite, marcasite and monosulphides. In contrast, sulphate minerals can be grouped as highly soluble basic or acidic, moderately soluble basic, low solubility acidic and extremely insoluble.*

*The objective in sulphur analysis is to identify and measure the concentration and composition of different sulphur species with sufficient accuracy and precision. This is important for the calculation of acid generation potential (AP) and the prediction of elemental release under potential weathering conditions. There are several methods for measuring sulphur species discussed in this chapter. For example, Leco is a manufacturer of high temperature induction furnaces, whose name has become synonymous with the most common method for determining total carbon and sulphur. All methods have strengths and weaknesses, which should be understood for proper predictions from analytical data.*

### 12.1 Introduction

#### 12.1.1 Sulphur Species

Sulphur species are the primary source of acid, acidity and potentially deleterious elemental species in the drainage from sulphidic geologic materials. Acid and acidity may be produced by the oxidation of reduced sulphur and the release of acidic cations. The reactions, released chemical species, and reaction rates for sulphur species are a function of their:

*Sulphur species are the primary source of acid, acidity and potentially deleterious elemental species in the drainage from sulphidic geologic materials.*

- abundance;
- oxidation state of the sulphur;
- major, minor and trace elements bonded with the sulphur;
- other chemical and physical properties of the minerals; and
- environmental conditions.

Sulphur species vary greatly in the effects of their constituents. Furthermore, not all sulphur species produce acid and potentially acid generating sulphur species differ in acid produced per mole of sulphur. Measurement of the concentration and composition of sulphur species or types of species is therefore a key part in the prediction of the drainage chemistry of sulphidic geologic

materials and should be part of the characterization of all potentially disturbed sulphidic geologic materials.

The main types of sulphur species are:

- sulphide and sulphosalt minerals containing sulphides ( $S^{2-}$ ) or disulphides ( $S_2^{2-}$ );
- sulphate minerals ( $SO_4^{2-}$ );
- sulphur species with intermediate oxidation states; and
- organic sulphur.

#### 12.1.1.1 Sulphide Sulphur

The primary reduced sulphur species are monosulphide ( $S^{2-}$ ) and disulphide ( $S_2^{2-}$ ) minerals. Oxidation, hydrolysis and dissolution of components of sulphide minerals may release contaminant elements and acidity into solution, produce heat and lower the oxidation potential of the solution.

Sulphide sulphur primarily occurs combined with iron in minerals such as pyrrhotite and pyrite.

*Sulphide sulphur primarily occurs combined with iron in minerals such as pyrrhotite and pyrite.*

Other common sulphide minerals, such as chalcopyrite (Cu, Fe), arsenopyrite (As, Fe), sphalerite (Zn, Fe), and galena (Pb), include trace elements as major constituents. Minor and trace lattice impurities or foreign inclusions in pyrite and pyrrhotite are other

potentially large sources of potentially harmful elements.

#### 12.1.1.2 Sulphate Sulphur

Sulphate ( $SO_4^{2-}$ ) is the most oxidized form of sulphur in natural waters. Sulphate minerals vary widely in their composition and solubility and can be an important source of acidity, major ions and potentially harmful trace elements.

Sulphate minerals may be deposited by geological processes prior to project development or by the precipitation of sulphate released by weathering processes after project development. Previously unweathered sulphidic geologic materials often contain little sulphate. However, sulphate minerals are most likely present in relatively high concentrations in sulphidic geologic materials that were:

- hydrothermally altered;
- oxidized by supergene processes; or
- formed under evaporative and marine conditions.

Dissolution of pre-existing sulphate minerals is often a major source of elements observed in the initial drainage and during flushing events.

Basic sulphate minerals include: calcium, magnesium, sodium and barium sulphates. The most common acidic sulphate minerals are iron and aluminum sulphates. Other acidic sulphate minerals include sulphates containing trace metals such as copper and zinc. Dissolution of

sulphate minerals may lower the drainage pH directly through the release of acidity or indirectly through the exchange of released basic cations with adsorbed protons on exchange sites.

### 12.1.1.3 Other Sulphur Species

Other sulphur species include those at intermediate oxidation states and organic sulphur. Organic sulphur occurs in geological materials that contain organic matter, such as coal, mudstones, organic surficial materials, such as peat, and other geological materials that support plant growth. Organic sulphur generally does not produce considerable net acidity on oxidation, although it may be a locally significant source of acidity in the form of organic acids (Ahern et al., 2004). Organic ligands can complex iron, aluminum and a large variety of trace elements released from the weathering of other inorganic sulphur species.

The primary concern with organic sulphur is its potential interference with analytical methods used to estimate the concentration of sulphide-sulphur and lower solubility, acidic sulphate minerals. The ratio between carbon and sulphur in soil organic matter ranges from 75:1 to 150:1 and is typically 100:1 (Brady, 1990).

Sulphur species with intermediate oxidation states, such as elemental sulphur and thiosalts (e.g.  $S_2O_3^{2-}$ ,  $S_3O_6^{2-}$  and  $S_4O_6^{2-}$ ), are usually present in low concentrations. However, they may be a concern in certain situations, such as flooded massive sulphide tailings.

## 12.1.2 Objectives

The objective in sulphur analysis is to identify and measure the concentration and composition of different sulphur species with sufficient accuracy and precision to predict potential acid generation and elemental release under potential weathering conditions. Study requirements and analytical procedures will depend on which sulphur species are present in significant concentrations, the disposal environment and mitigation measures.

*The objective in sulphur analysis is to identify and measure the concentration and composition of different sulphur species with sufficient accuracy and precision. This is important for the prediction of potential acid generation and elemental release under potential weathering conditions.*

Information on potential acid generation from sulphur species is required to predict concentrations and loadings of acidity and the resulting drainage acidity and pH. Information on major and minor ions and potential elemental release from sulphur species is required to predict concentrations and loadings of potentially harmful chemical species and the drainage chemistry parameters that contribute to element speciation, secondary mineral precipitation and solubility limits. The word “potential” is used because weathering and the eventual contribution of sulphur minerals to drainage chemistry will depend on other properties and processes, such as acid neutralization, the disposal environment and mitigation measures.

The identity of the sulphur species will indicate:

- major elemental constituents;
- weathering reactions that will release contaminants and the relative reactivity under different conditions; and
- potential extraction by selective wet chemical and roasting procedures.

The variable compositions, lattice impurities and foreign inclusions in major reactive sulphide

*The variable compositions, lattice impurities, or foreign inclusions in major reactive sulphide and sulphate minerals may be needed to predict potential loadings and mechanisms of contaminant release.*

and sulphate minerals (e.g. melanterite, pyrite and pyrrhotite) may be needed to predict potential loadings and mechanisms of contaminant release.

Information that may be needed to predict potential acid generation from sulphur species includes:

- concentration of sulphide-sulphur;
- concentration and composition of different sulphide species;
- degree to which sulphide-sulphur can be more or less acid generating than iron sulphide at near-neutral and alkaline pH;
- concentration of water soluble acidic sulphate species (e.g. melanterite);
- concentration of relatively insoluble acidic sulphate species (e.g. jarosite);
- degree to which water soluble and relatively insoluble sulphate-sulphur can be more or less acid generating than iron sulphide at near-neutral and alkaline pH; and
- concentration of intermediate sulphur species capable of generating acidity.

Where the concentration of less easily measured acidic sulphur species is calculated by subtraction of the more easily measured sulphur species from total sulphur, the information needed to predict potential acid generation from sulphur species may also include:

- concentration of basic sulphate species (e.g. calcium sulphate); and
- concentration of organic sulphur.

Prediction of acid generation by sulphide oxidation should indicate the likelihood of delays in acid generation due to galvanic interaction between different sulphide minerals. Prediction of acid generation by sulphate dissolution should indicate the degree to which the acidity occurs in highly soluble and relatively insoluble acidic sulphate minerals.

In conjunction with kinetic tests and field studies, the analysis of individual sulphate fractions and minerals includes assessment of:

- whether sulphate comes from the dissolution of pre-existing sulphates or subsequent sulphide oxidation;
- whether calcium comes from the dissolution of pre-existing calcium sulphates or carbonate dissolution; and
- the duration of release of chemical species by sulphate dissolution and how long it will mask the rate of release of chemical species by sulphide oxidation.

Although there is a large list of potential information requirements, often only two or three, and sometimes only one, sulphur species are present in sufficiently high concentrations to pose a concern and require analysis. After confirming which sulphur species occur in concentrations too low to pose a concern, the actual information requirements are usually greatly reduced.

### 12.1.3 Overview of Methods

Laboratory analyses and calculations to estimate the type and concentration of different sulphur species and categories of sulphur species include:

- geological and mineralogical analyses (e.g. Chapter 17);
- volatilization (pyrolysis or roasting) procedures;
- wet chemical extraction procedures (Chapter 11); and
- solid phase elemental analysis (Chapter 10).

The advantages of volatilization, wet chemical extraction and solid phase elemental analyses are that the analyses are quantitative and relatively rapid. The main disadvantages are the potential contribution of several types of sulphur species to the measured sulphur percentage, and the potential lack of accuracy in measuring specific sulphur species or categories of sulphur species. Mineralogical analysis may be needed to check assumptions regarding the sulphur fractions or species measured using the total sulphur, selective extractions and whole rock or near total solid phase elemental analysis.

The concentration of the less easily measured sulphur species may be calculated by subtraction of the more easily measured sulphur species from total sulphur. For example, where sulphate species are more easily measured than sulphide, the concentration of sulphide-sulphur may be determined by subtraction of sulphate-sulphur from total sulphur, provided the concentration of all other sulphur containing species are insignificant.

*The concentration of less easily measured sulphur species may be calculated by subtraction of more easily measured sulphur species from total sulphur.*

A number of procedures for measuring the concentration of sulphur species involve sequential extractions conducted on the same sub-sample. An example is the ASTM Method D 2492 for acid leachable sulphate analysis, in which the nitric acid procedure is conducted on the sample previously leached with HCl. Potential disadvantages of sequential extraction are:

- errors are compounded throughout the test;
- nitric acid may oxidize sulphide and other reduced sulphur species;
- the weight of sulphur extracted must be measured by analysis of the leachate or precipitation of the extracted sulphate as BaSO<sub>4</sub> rather than the Leco procedure; and
- conducting test procedures in series is time consuming.

An advantage of sequential leaching is that it reduces errors due to differences in the composition of the sub-samples used for parallel selective extractions.

## 12.2 Methods of Geological and Mineralogical Analysis

Geological and mineralogical analyses are needed to:

- identify which sulphur species or categories of sulphur species are present;
- determine the spatial distribution of different sulphur species;
- check species identification and concentration measurements by other analyses; and
- determine major, minor and trace constituents of sulphur minerals.

Information on geological properties and processes may suggest the probability of occurrence of different sulphur species and their spatial distribution (Chapter 6). For example, geological processes such as hydrothermal alteration or oxidized weathering conditions commonly produce sulphate minerals.

*Geological processes such as hydrothermal alteration or oxidized weathering conditions commonly produce sulphate minerals.*

Visual analysis may reveal the occurrence and distribution of relatively common and coarse grained sulphur containing minerals. Petrographic analysis, XRD and image analysis can show the relative concentrations of different sulphur minerals (Chapter 17). Rietveld analysis of XRD data can typically measure the concentration of mineral phases of sulphur that occur in concentrations higher than 0.2%. Image analysis with SEM-EDS, electron microprobe, laser ablation and other microbeam techniques, is capable of measuring the elemental composition and has a lower detection limit for sulphur minerals than XRD and petrographic analysis (Chapter 17).

Potential limitations of mineralogical analyses include the following:

- methods, such as visual analysis and petrographic analysis, may be unable to detect or measure fine grains or low concentrations of some sulphur species;
- the poorly crystalline nature of some secondary sulphate minerals may hamper characterization; and
- the specialized equipment and specially trained personnel required for all these methods, but especially for methods capable of analyzing small grains, low concentrations and the chemical composition, may be unavailable locally.

## 12.3 Methods of Pyrolysis or Roasting

Volatilization is the change of a solid or liquid to a gas or vapour. Volatilization due to pyrolysis at 1500 to 1700°C in a high temperature furnace is the standard analytical procedure for total-sulphur. Volatilization due to pyrolysis at 550°C is one of the methods used to measure the concentration of sulphide-sulphur.

### 12.3.1 High Temperature Furnace

Total sulphur can be measured with a high temperature furnace apparatus that:

- heats a sample to 1500 to 1700°C in the presence of oxygen; and
- measures the resulting concentration of sulphur dioxide in the gas phase.



A high temperature induction furnace is reliable, cost-effective, quick and can be used to measure both total carbon and total sulphur. Temperatures of 1500 to 1700°C in the presence of oxygen will transform all the sulphur species within a sample into sulphur dioxide. A stream of CO<sub>2</sub>-free oxygen then carries the vapour through an infrared spectrometric cell, wherein the concentrations of carbon and sulphur are determined by the absorption of specific infrared wavelengths or detected by non dispersive infrared CO<sub>2</sub> analyzers. Sulphur dioxide absorbs infrared radiation proportionally to its concentration and the absorbed radiation is measured by infrared detectors. Accelerators are used to quantitatively convert all forms of sulphur to sulphur dioxide.

A halogen trap containing antimony and potassium iodide should be installed in the gas stream to prevent chlorine and fluorine gas generated during sample combustion from interfering with the sulphur dioxide measurement, leading to overestimation of the total sulphur content. Removal of chlorine is especially important if samples are a residue from an HCl leach. Prior washing extends the life of the trap.

Water also absorbs infrared radiation and the sample gas stream must be dried completely with magnesium perchlorate or other drying agents.

An induction furnace can also be used to convert carbon and sulphur to their oxides which then can be quantitatively measured by other standard volumetric or titrimetric methods.

Volatilization in a high temperature furnace can be used to determine the total concentration of sulphur in the original sample (% total-sulphur) or the residual sulphur after wet chemical extraction of selected mineral phases or volatilization at 550°C. The amount of sulphur removed by wet chemical extraction of selected mineral phases or volatilization at 550°C is determined from the difference in measured sulphur before and after the extraction.

#### 12.3.1.1 Leco Induction Furnace and Automatic Sulphur Titrator

Leco is a manufacturer of high temperature induction furnaces whose name has become

*Leco is a manufacturer of high temperature induction furnaces whose name has become synonymous with the most common method for determining total carbon and sulphur.*

synonymous with the induction furnace method for determining total carbon and sulphur. In the Leco method, the furnace is operated at or above ~1650°C, and all carbon and sulphur species are volatilized. Leco systems use a halogen trap.

#### Materials

1. Leco Induction Furnace and Automatic Sulphur Titrator, *prepared and operated according to the Operator's Manual and internal laboratory QA/QC and operating procedures.*
2. Balance, which can be read to 0.001 g.

### Procedure

1. Ignite the crucibles or boats for test samples in a muffle furnace for 1 h at 550°C.
2. Take a  $\sim 0.300 \pm 0.050$  g sub-sample of less than 60 mesh material and accurately determine its weight.
3. Disperse 1 heaping scoop of tungsten metal chip accelerator evenly over the sample aliquot in the combustion boat (do not mix). One scoop of tungsten is approximately 2.0 grams. Tungsten oxides, as well as tungsten metal, will act as catalyst in the oxidation of sulphur and carbon containing minerals.
4. Check to ensure that the water and halogen traps are in good condition. These chemical filters must be in good condition for accurate analysis and to protect the instrument from damage.
5. The furnace usually requires a warm up time of approximately 15 minutes.
6. Heat the sample to  $\sim 1650^\circ\text{C}$  in a Leco induction furnace while passing a stream of oxygen through the sample.
7. Measure the sulphur dioxide generated from the sample with an IR detector.
8. The total sulphur content of the sample is calculated by the instrument and reported.

Where the analyzed sample is the residue of some previous form of wet extraction, dry the filter paper with residue in a drying oven at 105°C for 2.5 to 3 hours. The samples must be completely dry to protect the analyzer. Use glass fiber rather than paper type filter paper if total carbon is being analyzed as well.

The detailed procedures for the preparation and analysis of sulphur with Leco equipment can be found in the equipment manuals.

### 12.3.2 Pyrolysis at 550°C

Volatilization by ignition at 550°C for an hour in a muffle furnace is used to measure the

*The assumption in ASTM Method E-1915-07a for sulphide-sulphur is that 550°C is hot enough to vaporize sulphide-sulphur by oxidation to sulphur gases, but will not vaporize sulphate-sulphur.*

concentration of sulphide-sulphur (ASTM Method E-1915-07a). The assumption in the use of this test is that 550°C is hot enough to vaporize sulphide-sulphur by oxidation to sulphur gases, such as sulphur dioxide (SO<sub>2</sub>), but will not vaporize sulphate-sulphur. The concentration of vaporized sulphur can be measured from the difference between total sulphur in a sub-

sample of the original material and total sulphur in the residue of a sub-sample after pyrolysis for an hour at 550°C. Use of adequate draft in the muffle furnace is necessary to avoid excessive adsorption of sulphur gases onto the test samples, leading to low sulphur loss by pyrolysis. The amount of sulphur lost may be measured directly by measurement of sulphur dioxide by infrared absorption, or indirectly by measurement of residual sulphur.

Heating for an hour at 550°C has the following effects (Li et al., 2007; Bucknam, 1999):

- complete volatilization of sulphide minerals such as pyrite, marcasite and arsenopyrite and almost complete volatilization of pyrrhotite;
- only partial volatilization of pentlandite and copper sulphide minerals (i.e. bornite and chalcopyrite) and volatilization of < 5% of galena and sphalerite, resulting in an under estimation of the sulphide-sulphur concentration if these minerals are present;

- partial volatilization of sulphate minerals such as hydrated sulphate minerals (e.g. gypsum), resulting in an overestimation of the sulphide-sulphur concentration if these minerals are present;
- no volatilization of the sulphur in sulphate minerals such as barite, alunite and jarosite;
- dehydration of sulphate minerals such as jarosite, resulting in a change in mineralogy and an increase in their acid solubility; and
- complete volatilization of organic sulphur.

The limited volatilization of some sulphide minerals and the complete or partial volatilization of some non-sulphide-sulphur species are potential limitations to consider when selecting this procedure to measure sulphide-sulphur and interpreting the results. This procedure is not recommended for sulphide-sulphur analysis where mineralogical characterization indicates the presence of significant concentrations of either organic sulphur and/or partially volatilizable sulphide. Prior extraction with water (Section 12.4.1) can be used to prevent the interference of highly soluble, volatilizable sulphate minerals. XRD analysis of the residue may be used to verify the effectiveness of the extraction.

Li et al. (2007) noted the importance of maintaining a pyrolysis temperature at or slightly below 550°C as further decomposition and volatilization to SO<sub>3</sub> gas from jarosite may occur above 550°C.

The procedure for pyrolysis at 550°C adapted from ASTM E 1915 – 07a is as follows:

1. Ignite the crucibles or boats to be used in the analysis in a muffle furnace for 1 h at 550°C
2. Weigh two ~0.300 g ± 0.050 g sub-samples of less than 60 mesh (<250 µm) material and record the weight to 0.001 g.
3. Transfer samples into crucibles or boats.
4. Ignite the crucible or boat containing one of the sub-samples for an hour in a well-ventilated muffle furnace at 550 °C, and then cool.
5. Measure total-sulphur in the original sub-sample, and the residue after pyrolysis for one hour at 550°C, using the Leco Induction Furnace and Automatic Sulphur Titrator (Section 12.3.1.1).
6. Calculate the sulphur concentration loss after pyrolysis for the test samples % A, as follows:  
A = B – C where: B = total sulphur result, %, and C = residual sulphur from pyrolysis result, %.

#### 12.4 Methods of Wet Chemical Extraction

In wet chemical analysis, a selective solvent is employed to isolate a major mineralogical phase in the sample. The sulphur species extracted and resulting chemical speciation will be influenced by (Bucknam, 1999):

*In wet chemical analysis, a selective solvent is employed to isolate a major mineralogical phase.*

- analysis variables such as type and concentration of extractants, temperature, contact time, agitation and atmosphere of reaction; and
- mineralogical composition and physical form of a sample and solubility of mineralogical phase in the sample.

The sample composition will affect the assay due to the presence of certain substances which may intensify or retard the extraction conditions, such as the acidity or the oxidation conditions. If a sulphur species of interest is occluded in a hard impervious siliceous gangue, its complete extraction will be more difficult than if it occurs as large grains in a soft, porous matrix.

Wet chemical extractions of selected sulphur phases include digestion and dissolution in:

- water;
- HCl;
- sodium carbonate; and
- nitric acid.

Similar to other wet extractions (Chapter 11), sulphur wet extraction methods may vary in the following:

- ratio of leachate to sample;
- strength of leachate;
- whether the sample and leachate are boiled;
- whether the extraction is part of a sequential extraction or the sample has been subjected to some previous treatments; and
- the manner in which leached chemical species are measured.

Sample preparation should include drying and grinding to a powder (Chapter 8).

The percentage of sulphur and sulphur species removed by wet chemical extractions can be estimated from:

- difference in total sulphur before and after the extraction;
- ICP analysis of the leachate;
- gravimetric analysis of the weight of  $\text{Ag}_2\text{S}$  or  $\text{BaSO}_4$  precipitated from the extract; and
- turbidimetric analysis of  $\text{BaSO}_4$  precipitated from the extract.

Beware that acid may cause corrosion problems for the ICP. Mineralogical analysis of the residue should be used to check assumptions where there is uncertainty regarding the completeness or proportion of removal of an important sulphur species.

The calculation of the extractable element as weight-percent (wt%) in a sample from ICP results is as follows:

$$\text{wt\%} = [\text{ICP (mg/L)} / \text{sample wt (g)}] \times \text{vol of leachate (L)} \times 0.1$$

where sample wt is the extracted sample weight in grams and ICP is the concentration in mg/L measured in the extract. The concentrations of different extractable minerals in the sample can then be estimated from the extractable elements and the stoichiometries of the minerals.

$\text{Ag}_2\text{S}$  or  $\text{BaSO}_4$  collected for gravimetric analysis may also be used to determine the isotopic composition of the contributing sulphur phases.

Potential advantages of wet chemical procedures are that they can be quicker, less expensive and have lower detection limits than mineralogical techniques. XRD may fail to identify soluble sulphur species occurring in trace amounts, or as a non-crystalline phase. The main disadvantage is that selective wet chemical extractions are not mineral specific and there can be additional mineral sources

*Advantages of wet chemical procedures are that they can be quicker, less expensive and have lower detection limits than mineralogical techniques. The main disadvantage is that they are often not mineral specific.*

for dissolved sulphur and cations.

Another important consideration is that site specific differences in the composition of a sulphur mineral may result in site specific solubility differences.

### 12.4.1 Water

The purpose of extraction with water is to measure the concentration of highly soluble sulphate minerals, such as melanterite ( $\text{FeSO}_4 \cdot 7\text{H}_2\text{O}$ ) and epsomite ( $\text{MgSO}_4 \cdot 7\text{H}_2\text{O}$ ), as well as moderately soluble sulphate minerals, such as gypsum ( $\text{CaSO}_4 \cdot 2\text{H}_2\text{O}$ ). The solubilities of melanterite, epsomite and gypsum are 156.5, 710 and 2.41 g/L, respectively in water (Weast, 1976). Due to their relatively high solubility, these minerals may exert a strong influence on drainage chemistry even if they occur in trace amounts and are a minimal proportion of the % sulphur.

The analysis procedure should provide sufficient dilution and time to allow complete dissolution. Gypsum up to 9.6 wt.% with a solubility of 2.41 g/L will dissolve in a 1:40 ratio of test sample to water. Kinetics will limit the rate of dissolution of larger gypsum grains and gypsum in larger particles, such as those used in a humidity cell. However, gypsum ground to  $< 75 \mu\text{m}$  ( $< 200$  mesh) dissolves rapidly if there is sufficient dilution. Li et al. (2007) noted that with a 1:40 ratio of solid to water, 100% of the 5 wt% gypsum in a sample in a  $\leq 75 \mu\text{m}$  sample dissolved in 3 minutes, but only  $\sim 1.3\%$  and  $\sim 0.5\%$ , respectively, of the 5 wt% jarosite and pyrite dissolved in an hour.

Maintaining anoxic conditions may be important during the water leach procedure if soluble ferrous iron sulphate minerals are present. Dissolved  $\text{O}_2$  in the water will oxidize ferrous iron from melanterite to ferric iron. Then, ferric iron precipitation by hydrolysis above  $\sim \text{pH } 3.5$  will make it impossible to estimate the iron sulphate concentration from the dissolved iron. Maintaining anoxic conditions may also be required if the pH is below 3.5 to prevent ferric iron from oxidizing the sulphide minerals and producing additional sulphate.

The water extraction procedure based on the method outlined by Li et al. (2007) is as follows:

1. Accurately weigh  $2 \text{ g} \pm 0.01 \text{ g}$  of a sample and place it in a 175 mL plastic bottle.
2. Add 80 mL of argon purged water to make a 1:40 suspension. The void space is purged with argon gas to remove air before closing the bottle.
3. Stopper the bottle and leach for 3 min in an orbital mixer, with the temperature controlled at  $20^\circ\text{C}$ .
4. Filter the slurry through a  $0.2 \mu\text{m}$  membrane to obtain a clear extract then split the extract into two: one oxidized with 2 drops of 30%  $\text{H}_2\text{O}_2$  for acidity measurement and the other

acidified (to pH~1) with 2 drops 69% HNO<sub>3</sub> to prevent precipitation of Fe(OH)<sub>3</sub> in the solution for total Fe, Mg, Ca and S determination by ICP analysis.

5. Thoroughly wash the solid residue on the filter paper with argon-purged Milli-Q water.
6. Transfer the filter with filter cake (sample residue) to a combustion boat.
7. Transfer combustion boats to a drying oven at 105°C for 2.5 to 3 hours. The samples must be completely dry to protect the analyzer.
8. Measure (residual) total sulphur in dry sample residue with Leco Induction Furnace and Automatic Sulphur Titrator (Chapter 12.3.1.1) for sulphur mass balance calculation.
9. The sulphur loss is determined from the difference in total sulphur before and after the extraction. Calculate the sulphur concentration loss after water extraction for the test samples % A, as follows:  $A = B - C$  where: B = total sulphur result, %, and C = residual sulphur after the water extraction result, %.

Note: The ratio of solid to water can be increased where high concentrations indicate there may be solubility constraints for gypsum or other soluble sulphate minerals. The argon purging can be done with welding grade argon/hydrogen gas mixtures.

Analysis of metal cations in the extracted filtrate by ICP (or Atomic Absorption Spectrometry) can be used to estimate the composition of the extracted sulphate minerals if the metal cations do not precipitate and there are no other mineral sources for those elements. An alternate source for Ca, Mg and Fe is the dissolution of carbonate minerals. The highest rates of carbonate dissolution will be in a ground acidic mine waste that exposes carbonate minerals occluded in the coarse fragments to the surficial acidity. Carbonate interference will be less at near-neutral and alkaline pH.

#### 12.4.2 Hydrochloric Acid

Leaching with hydrochloric acid has the following effects on sulphur minerals (Ahern et al., 2004; Tuttle et al., 2003) (Tables 12.1 and 12.2):

- complete dissolution of highly soluble sulphate salts, such as melanterite and epsomite and less soluble sulphate species such as gypsum;
- variable dissolution of relatively insoluble iron and aluminum hydroxyl sulphates (e.g. jarosite and alunite), as well as some sulphur from organic matter;
- variable volatilization to hydrogen sulphide gas (H<sub>2</sub>S) of monosulphides, such as pyrrhotite, galena, sphalerite and chalcopyrite; and
- negligible removal of pyrite, arsenopyrite and molybdenite and insoluble sulphate minerals barite (BaSO<sub>4</sub>), anglesite (PbSO<sub>4</sub>) and celestite (SrSO<sub>4</sub>).

Sulphate-sulphur removal by hydrochloric acid is by dissolution. Sulphide-sulphur removal is initially as H<sub>2</sub>S gas and therefore the extraction should occur in a fume hood. A portion of the resulting H<sub>2</sub>S gas may be oxidized to sulphate and dissolved along with sulphate minerals by hydrochloric acid under oxidizing conditions.

The degree of sulphate, sulphide and organic sulphur removal by hydrochloric acid and the resulting sulphur species (e.g. dissolved sulphate or H<sub>2</sub>S gas) will depend on the:

- type and composition of the sulphate and sulphide minerals and organic sulphur compounds;

- physical properties (e.g. particle size);
- analytical conditions such as the:
  - manner and time of exposure to hydrochloric acid;
  - ratio of HCl to test sample;
  - other properties of the test sample (e.g. presence of ferric iron);
  - strength of the HCl; and
  - whether the sample and HCl are heated; and
- pretreatments, such as, pyrolysis and other wet extractions.

All the methods of hydrochloric acid extraction contain steps to prevent hydrochloric acid from interfering with the subsequent analysis of the residue or the leachate. Careful washing of the leached residue prior to total sulphur analysis is needed to prevent chlorine from interfering with infrared detection (Charles Bucknam, personal communication, 2008). Leco systems use a halogen trap and careful washing of the leached residue extends the life of the trap. Li et al. (2007) found that hydrochloric acid in an undiluted test solution interfered with measured ICP concentrations by factors of up to 25%. They therefore diluted the hydrochloric acid extraction solution 10 times before ICP analysis.

Heating, higher strength and longer exposure to hydrochloric acid, and pyrolysis prior to hydrochloric extraction will increase the removal of relatively insoluble iron and aluminum hydroxyl sulphates (e.g. jarosite and alunite), sulphur from organic matter and monosulphides (e.g. pyrrhotite, galena, sphalerite and chalcopyrite).

#### 12.4.2.1 EPA-600 – Hydrochloric Acid Method

This hydrochloric acid method is based on the procedures of Sobek et al. (1978) and part of the EPA-600 Acid Base Accounting (ABA). In the EPA-600 procedure, a ~0.500 g, < 60 mesh sample is leached with 50 mL of 4.8 M (40%) hydrochloric acid. The EPA-600 procedure has the shortest period of exposure of the sample to hydrochloric acid and lacks heating or boiling and is therefore the least aggressive of the hydrochloric acid methods in removing acid volatile sulphide-sulphur.

The EPA-600 hydrochloric acid method is primarily used to measure the concentration of gypsum and anhydrite in near-neutral and alkaline pH sulphidic geological materials. Sulphur extracted by this procedure is sometimes called acid soluble sulphate-sulphur.

Unlike other stronger and longer hydrochloric acid methods, the short exposure and cold hydrochloric acid used in the EPA-600 method should minimize the removal of sulphur from relatively insoluble iron and aluminum hydroxyl sulphates, organic matter and monosulphides. In the absence of organic matter and acid insoluble sulphate minerals, sulphide-sulphur can be calculated from total sulphur minus EPA-600 hydrochloric acid leachable sulphur, and the acid potential (AP) can be calculated from sulphide-sulphur.

Total sulphur minus hydrochloric acid leachable sulphur will underestimate the AP in a sample containing soluble acidic sulphate minerals.

### Chemicals

1. 4.8 M (40%) hydrochloric acid (HCl), 2 parts acid to 3 parts water: Mix 400 mL of concentrated HCl with 600 mL of distilled water.
2. Silver nitrate (AgNO<sub>3</sub>), 10%: Dissolve 10.0 g of AgNO<sub>3</sub> in 90 mL of distilled water. Store in amber bottle away from light.

### Materials

1. Funnels, 71.1 cm (28") I.D. polyethylene.
2. Filter paper, 14 cm (5.5") glass fibre.
3. Flasks, Erlenmeyer, 250 mL.
4. Beakers, 100 mL.
5. Syringe.
6. Balance, can be read to 0.001 g.

### Procedure

1. Place a ~0.500 g sub-sample of less than 60 mesh (<250 μm) material in a filter.
2. Place sub-sample and filter onto funnel holder in sink or other suitable pan which can receive outflow from funnel.
3. Using a syringe, pipette or other graduated dispenser, add 40% HCl to almost the top of the filter paper. Caution: During this step and all other leaching steps, be careful not to lose any sample by runover, splashing, or breaking through the filter paper.
4. Repeat step 6 until a total of 50 mL of acid has been added.
5. Place funnel holder, containing funnel and sub-sample, over a 100 mL beaker.
6. Leach sub-sample with 50 mL of distilled and deionized water. Discard leachate. Note: Stop here if procedure cannot be completed in one day. Caution: Samples must be kept moist.
7. Leach sub-sample with another 50 mL of distilled and deionized water to remove chlorides and nitrates by water leaching after the hydrochloric acid extraction before measuring total sulphur.
8. Test leachate for chlorides by adding 3 drops of 10% AgNO<sub>3</sub> with a dropper. Note: The presence of chlorides will be detected by a white precipitate.
9. Discard leachate and repeat steps 10 and 11 until no precipitate forms.
10. Discard leachate.
11. Transfer the filter with filter cake (sample residue) to a combustion boat.
12. Transfer combustion boats to a drying oven at 105°C for 2.5 to 3 hours. The samples must be completely dry to protect the analyzer.
13. Measure [residual] total sulphur with Leco induction furnace (Section 12.3.1.1).

The sulphur loss (acid leachable sulphate) is determined from the difference in measured sulphur before and after the extraction. Solid phase elemental analysis of the filter cake or chemical analysis of the extracted filtrate by ICP methods (or Atomic Absorption Spectrometry) can be used to identify the concentration of chemical species extracted by hydrochloric acid.



### 12.4.2.2 ASTM E 1915 – Hot Hydrochloric Acid Method

In the ASTM E 1915 method, 25 mL of 20% hydrochloric acid is added to  $0.200 \pm 0.01$  g < 200

*The longer time of exposure and boiling will be expected to result in greater removal of relatively insoluble iron and aluminum hydroxyl sulphates, organic sulphur and monosulphides than the EPA-600 – Hydrochloric Acid Method.*

mesh (< 74  $\mu\text{m}$ ) sample, let stand at room temperature for 30 minutes, and gently boiled for 10 minutes. The longer time of exposure and boiling will be expected to result in greater removal of relatively insoluble iron and aluminum hydroxyl

sulphates (e.g. jarosite and alunite), sulphur from organic matter and monosulphides than the EPA-600 – Hydrochloric Acid Method.

The procedure for analysis of hot hydrochloric acid extractable sulphur adapted from ASTM E 1915 – 07a is as follows:

1. Weigh  $0.200 \pm 0.01$  g < 200 mesh (< 74  $\mu\text{m}$ ) sample into 150 mL beaker and record weight.
2. Add 25 mL of 1 part concentrated acid to 4 parts water (20% v/v) hydrochloric acid in a beaker.
3. Let stand at room temperature for 30 minutes.
4. Cover with a watch glass, place on a hot plate.
5. Gently boil for 10 minutes.
6. Remove from the hot plate and cool.
7. Filter through a fine porosity glass micro filter (carbon content must be less than 0.15%, sulphur content must be less than 0.05% and the filter weight must be less than 0.2 g).
8. Wash with water at least three times and discard filtrate.
9. Transfer the filter with filter cake (sample residue) to a combustion boat.
10. Transfer combustion boats to a drying oven at 105°C for 2.5 to 3 hours. The samples must be completely dry to protect the analyzer.
11. Measure (residual) total sulphur with Leco induction furnace (Section 12.3.1.1).

The sulphur loss is determined from the difference in measured sulphur before and after (filter cake) the extraction. Also, analysis of the extracted filtrate by ICP methods (or Atomic Absorption Spectrometry) can be used to identify the concentration of chemical species extracted by hydrochloric acid.

This method is suitable for samples containing approximately 0.02 to 5% sulphur. Material containing higher or lower concentrations can be analyzed with reasonable accuracy by adjusting the sample size taken for analysis.

### 12.4.2.3 Soluble and Volatile Sulphur Extraction under Anoxic Conditions with Hot Hydrochloric Acid

Extraction with hot hydrochloric acid under anoxic conditions allows separate measurement of dissolved sulphate (acid soluble sulphate-sulphur) and H<sub>2</sub>S gas (acid volatile sulphide-sulphur). Tuttle et al. (2003) used measurement of acid soluble sulphates and acid volatile sulphides as steps 3 and 4 in the following scheme for measuring different forms of sulphur:

1. soluble acetone at ambient temperatures (elemental sulphur);
2. soluble in water at ambient temperatures (water soluble sulphates, see Section 12.4.1);
3. soluble in hot 6 N HCl (acid soluble sulphates);
4. volatile as H<sub>2</sub>S in hot 6 N HCl (acid volatile monosulphides);
5. volatile as H<sub>2</sub>S in hot HCl/Cr<sup>2+</sup> (disulphides, see Section 12.4.2.4); and
6. residual after all other phases removed (refractory sulphates such as barite).

This method can be made more specific for less soluble sulphate minerals if a previous water extraction is used to remove soluble sulphate. According to Tuttle et al. (2003), hot hydrochloric acid totally dissolved 0.42 % jarosite in a composite from different mines and a sample created from mineral standards.

The proportion of sulphur removed by volatilization upon boiling with 6 M hydrochloric acid depends on the type and composition of the sulphide mineral. Boiling with 6 M hydrochloric acid is effective in removing a number of monosulphide minerals but removes very little sulphur from disulphide minerals, such as pyrite and arsenopyrite (Table 12.1). Sulphur removed from pyrite and arsenopyrite by hot hydrochloric acid in the studies of Tuttle et al. (2003) and Li et al. (2007) was ascribed to reduction of microcrystalline pyrite by stannous chloride (SnCl<sub>2</sub>) and dissolution of previous surface oxidation.

Stannous chloride is a reducing agent that is added to prevent ferric iron from oxidizing H<sub>2</sub>S. Tuttle et al. (2003) recommended that the added SnCl<sub>2</sub> correspond closely with the hydrochloric acid soluble ferric iron in order to minimize the reaction of SnCl<sub>2</sub> with pyrite. Table 12.1 shows the results from hot hydrochloric acid and hot hydrochloric acid / chromium chloride extractions with and without SnCl<sub>2</sub>

The degree of removal of sulphur from different monosulphide minerals by hot 6 M hydrochloric acid varies greatly. Tuttle et al. (2003) reported over 88 % sulphur removal from chalcocite, galena, pyrrhotite and sphalerite and 73 to 85% sulphur removal from bornite, chalcopyrite, and pentlandite in the procedure with added SnCl<sub>2</sub>. The %S removal of the disulphides arsenopyrite and pyrite and the monosulphide molybdenite as H<sub>2</sub>S was < 3% in the procedure with added SnCl<sub>2</sub>

*Hydrochloric acid is much more effective in removing sulphur from monosulphide minerals than disulphide minerals, although the degree of removal varies greatly between minerals and with different hydrochloric acid treatments.*

and 0% without SnCl<sub>2</sub>

Differences in monosulphide removal will result from differences in hydrochloric acid extraction methods. The higher extraction of monosulphide minerals, such as chalcocite, chalcopyrite, pentlandite and sphalerite, reported by Tuttle et al. (2003) compared to Li et al. (2007) can be attributed to the higher strength of hydrochloric acid, lower ratio of hydrochloric acid to % S, heating, and the addition of SnCl<sub>2</sub>. Site specific differences in mineral composition may be partially responsible for differences in mineral extraction between some studies.

Amendments that improve monosulphide recovery are described by Hsieh et al. (2002). According to Rice et al. (1993), some monosulphides such as greigite and pyrrhotite require hot hydrochloric acid in order to dissolve completely.

**Table 12.1 Percent total sulphur removed by anoxic hot hydrochloric acid followed by hot hydrochloric acid / chromium chloride with and without SnCl<sub>2</sub> (from Tuttle et al., 2003).**

Mineral	Ideal Formula	% H <sub>2</sub> S-S w/o Sn		% H <sub>2</sub> S-S w Sn		% SO <sub>4</sub> -S	Total % S Removed
		HCl	HCl/ CrCl <sub>2</sub>	HCl	HCl/ CrCl <sub>2</sub>		
Arsenopyrite	FeAsS	0	9	0	7	7	14-16
Bornite	Cu <sub>5</sub> FeS <sub>4</sub>	37	22	67	43	5	64-115
Chalcocite	Cu <sub>2</sub> S	71	5	88	0	0	76-88
Chalcopyrite	CuFeS <sub>2</sub>	24	47	65	24	9	80-98
Enargite	Cu <sub>3</sub> AsS <sub>4</sub>	25	51	34	27	0	61-76
Galena	PbS	83	11	100	0	9	103-109
Molybdenite	MoS <sub>2</sub>	0	4	1	3	0	4
Orpiment	As <sub>2</sub> S <sub>3</sub>	41	11	35	13	0	48-52
Pentlandite	(Fe,Ni) <sub>9</sub> S <sub>8</sub>	51	8	73	0	12	71-85
Pyrite	FeS <sub>2</sub>	0	89	2	77	7	86-96
Pyrrhotite	FeS	63	8	88	0	9	80-97
Realgar	AsS	53	31	37	37	0	74-84
Sphalerite	ZnS	94	0	94	0	0	94

Notes: HCl = hot hydrochloric acid extraction; HCl/ CrCl<sub>2</sub> = hot hydrochloric acid / chromium chloride extraction; % H<sub>2</sub>S-S = % sulphur removed as H<sub>2</sub>S; % SO<sub>4</sub> -S = % sulphur removed as SO<sub>4</sub>; w Sn = with SnCl<sub>2</sub>; wo Sn = without SnCl<sub>2</sub>

The procedure for extraction of soluble and volatile sulphur with hot hydrochloric acid under anoxic conditions developed by Tuttle et al. (1986 and 2003) is as follows:

1. Accurately weigh approximately 5 g of sample.
2. If the sample contains ferric iron, add corresponding amounts of tin(II) chloride (2 - 15 g SnCl<sub>2</sub>).
3. Introduce sample into the round bottomed reaction flask of the reaction vessel and continuously flush with nitrogen.
4. Connect up the apparatus and flush it for 5 min with high purity grade nitrogen.
5. De-aerate the acid beforehand by the passing pure nitrogen through it.
6. Slowly introduce 80 mL of 6 M de-aerated hydrochloric acid through the dropping funnel.
7. Establish a slow flow of nitrogen through the whole system and allow the reaction to proceed at room temperature for 15 min.
8. Heat slowly until the solution just begins to boil, then reduce the heat to just below boiling and let simmer.
9. The H<sub>2</sub>S generated in the reaction flask passes through an aqueous wash solution buffered to a pH of 4.0 to collect any HCl vapours and is collected in an aqueous 0.1 M silver nitrate (AgNO<sub>3</sub>) solution as silver sulphide.

10. Continue the reaction until the silver sulphide has coagulated and no H<sub>2</sub>S is detected when paper wetted with silver nitrate solution is held in the gas stream issuing from the buffer.
11. Dry, weigh, and measure % sulphur of Ag<sub>2</sub>S on a filter (acid volatile sulphide).
12. Disconnect the apparatus, filter off the residual solids, wash them with water and dry them, saving the filtrate for acid soluble sulphate determination.
13. Filter the HCl solution and save filtrate for analysis of acid soluble sulphate and residue for analysis of acid insoluble sulphur.
14. Measure acid volatile sulphate in HCl solution by precipitating the sulphate as BaSO<sub>4</sub> with ten per cent w/w BaCl<sub>2</sub> solution, analysis of HCl solution with ICP-AES; or total sulphur minus (acid volatile sulphide + acid insoluble sulphur).

Note: The hydrochloric acid solution is prepared as a de-aerated solution to prevent H<sub>2</sub>S gas evolved from monosulphide species from being oxidized to sulphate. If precipitating BaSO<sub>4</sub>, add bromine water and boil; then precipitate the sulphate as BaSO<sub>4</sub>, filter (0.45 µm), dry, weigh and calculate the sulphur concentration.

#### 12.4.2.4 Soluble and Volatile Sulphur Extraction under Anoxic Conditions with Hot Hydrochloric Acid / Chromium Chloride

The hot hydrochloric acid / chromium chloride (CrCl<sub>2</sub>) method creates an acidified chromium (II) solution in an anoxic atmosphere that converts reduced inorganic sulphur (e.g. disulphides, monosulphides and elemental sulphur) to H<sub>2</sub>S (Ahern et al., 2004; Tuttle et al., 1986 and 2003). The evolved H<sub>2</sub>S may be collected as zinc sulphide (Ahern et al., 2004) or silver sulphide (Tuttle et al., 2003). Chromium reduction to H<sub>2</sub>S is specific to reduced inorganic sulphur phases and does not reduce or liberate organic or sulphate sulphur (Ahern et al., 2004; Canfield et al., 1986).

This method can be made more specific to iron disulphides if previous extractions are used to remove acid volatile sulphides and elemental sulphur. The method is commonly part of the sequential extractions used to measure different sulphur species in sediments and acid sulphate soils. In the analytical sequence proposed by Tuttle et al. (2003) to measure different forms of sulphur, the extraction with hot hydrochloric acid / chromium chloride is conducted on the solid residue from the hot hydrochloric acid treatment (see Section 12.4.2.3).

In addition to the removal of disulphides, such as pyrite, extraction with hot hydrochloric acid / chromium chloride increases the removal of monosulphides, especially copper sulphides such as bornite and chalcopyrite, which are only partially recovered by previous extraction with hydrochloric acid alone (Table 12.1). Hot hydrochloric acid / chromium chloride is not effective in extracting arsenopyrite. The hot hydrochloric acid / chromium chloride method has been widely used to analyze sediments and acid sulphate soils but has had limited use in the characterization of mined rock (Ahern et al., 2004; Tuttle et al., 2003).

*In addition to the removal of disulphides, such as pyrite, this procedure increases the removal of other sulphides such as copper sulphides not recovered by hot hydrochloric acid alone.*

The hot hydrochloric acid / chromium chloride procedure of Tuttle et al. (2003) is as follows.

1. Return dried residue from the hot hydrochloric acid treatment (Section 12.4.2.3) to a round bottomed reaction flask of the reaction vessel and add 10 mL of ethanol.
2. Connect up the apparatus and flush it with nitrogen.
3. Add a mixture of 50 mL of 1 M chromium (II) chloride ( $\text{CrCl}_2$ ) and 20 mL of de-aerated concentrated hydrochloric acid through the dropping funnel.
4. Establish a slow flow of nitrogen through the system and allow the reaction to proceed at room temperature for 15-30 minutes.
5. Heat the sample to boiling and allow the solution to boil slowly until  $\text{H}_2\text{S}$  generation ceases (no  $\text{H}_2\text{S}$  is detected when paper wetted with silver nitrate solution is held in the gas stream issuing from the buffer).
6. Collect evolved  $\text{H}_2\text{S}$  in a 0.1 M  $\text{AgNO}_3$  solution after passing through a pH 4 buffer to collect any HCl vapours.
7. Collect  $\text{Ag}_2\text{S}$  on a filter (0.45  $\mu\text{m}$ ), dry, weigh, and calculate acidified chromium volatile sulphur concentration.
8. Disconnect the apparatus, filter (0.45  $\mu\text{m}$ ) the hydrochloric acid / chromium chloride ( $\text{CrCl}_2$ ) solution, wash with water, dry the residual solids and save residue for residual sulphur extraction.
9. Measure sulphur in hydrochloric acid / chromium chloride ( $\text{CrCl}_2$ ) solution by precipitating the sulphate as  $\text{BaSO}_4$  with ten per cent w/w  $\text{BaCl}_2$  solution, analysis of HCl solution with ICP-AES; or total sulphur minus (acid volatile sulphide + acid insoluble sulphur).

#### 12.4.2.5 Pyrolysis at 550°C Followed by Hydrochloric Acid Extraction

Pyrolysis at 550°C for an hour prior to hydrochloric acid extraction will increase the extent and speed of removal of many less soluble sulphur minerals (Table 12.2), including:

- complete removal of jarosite;
- complete removal of copper sulphides and pyrrhotite;
- increased removal of pentlandite; and
- slightly increased removal of sphalerite and galena.

While ~90% of the jarosite (5 wt% S) in a synthetic sample was removed by leaching with 4 M hydrochloric acid for 16 h at 20°C, 100% was dissolved after leaching for only 30 minutes if the sample was previously roasted for an hour at 550°C (Li et al., 2007). In the same study, jarosite extraction from a laterite nickel sample was 39% with 4 M hydrochloric acid for 16 h and 100 % with 4 M hydrochloric acid for 30 minutes after pyrolysis for an hour at 550°C. Removal of 100% of the jarosite after roasting was due to a break down in structure as result of the loss of water. Li et al. (2007) noted the importance of roasting at or slightly below 550°C because further jarosite decomposition producing  $\text{SO}_3$  gas may occur above 550°C.

*Prior roasting will increase the extent and speed of removal of less soluble sulphur species by hydrochloric acid.*

**Table 12.2 Sulphur extracted by HCl pyrolysis at 550°C, and pyrolysis at 550°C followed by HCl (adapted from Li et al., 2007).**

	4M HCl (16 h) Total	550°C (1 h) Total	550°C (1 h) + 4M HCl (30 min)	
			Dissolved	Total
Sulphur Extracted/Lost (%)				
Jarosite	90		100	100
Pyrite	0	100		
Arsenopyrite	8	100		
Pentlandite	15	50	60	70
Sphalerite	24	5	8	30
Pyrrhotite	62	86	95	100
Galena	76	1	15	80
Covellite	11	50	97	100
Chalcocite	15	20	85	100
Bornite	21	35	95	100
Chalcopyrite	33	45	95	100

Note: The samples consisted of single sulphur minerals (5 wt% S) with quartz. Analysis of the residue was used to estimate the total % S extracted by 4 M cold HCl (16 h); roasting at 550°C (1 h); and roasting at 550°C (1 h) followed by 4 M cold HCl (30 min). Analysis of the leachate was used to estimate the dissolved %S extracted by 550°C (1 h) followed by cold 4 M HCl (30 min).

The pyrolysis / hydrochloric acid method developed by Li et al. (2007) was part of a three step sequential extraction procedure for estimating stored acidity (and AP) in acid mine waste rock containing pyrite, highly soluble sulphate minerals, such as melanterite and epsomite, moderately soluble sulphate minerals, such as gypsum, and less soluble sulphate minerals such as jarosite (Figure 12.1). The three step sequential extraction consists of:

1. an argon purged water extraction procedure (3 min) to remove highly and moderately soluble sulphate salts, such as melanterite, epsomite and gypsum (Section 12.4.1);
2. roasting at 550°C for 1 h to remove reactive sulphides (pyrite) (Section 12.3.2); and
3. 4 M HCl extraction (30 min) on the residue from the roast procedure to remove insoluble sulphate salts.

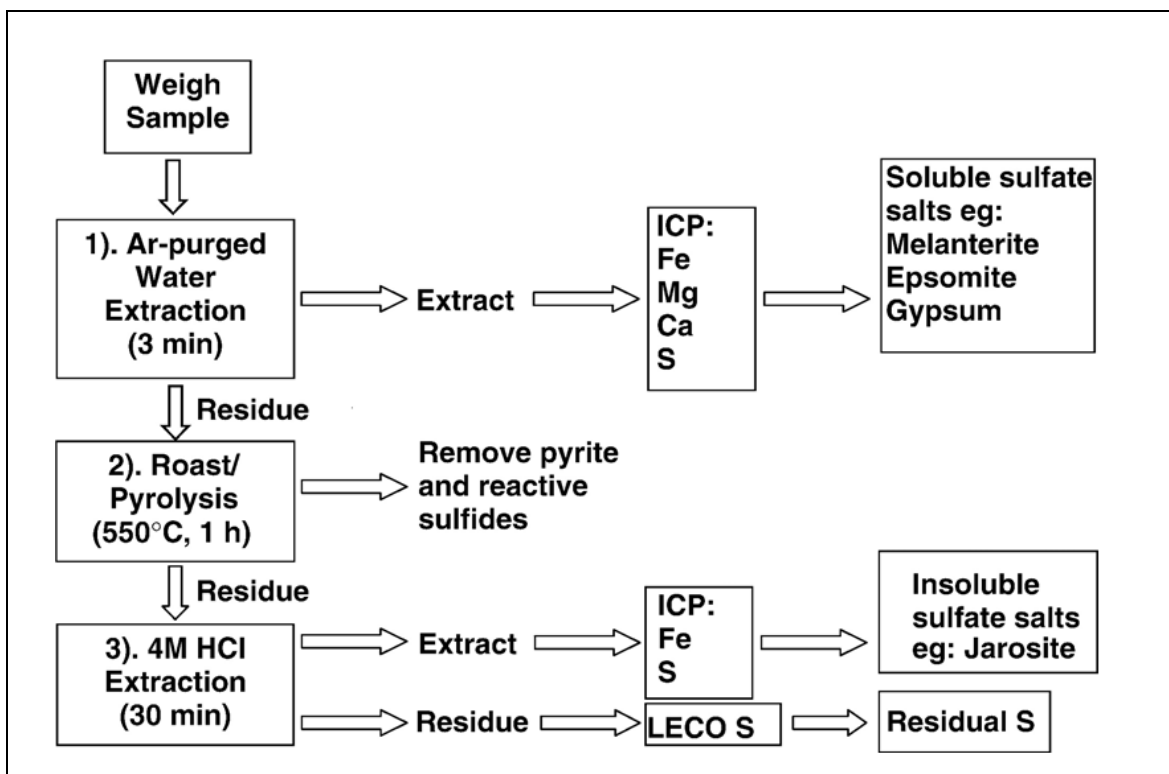


Figure 12.1 Three step sequential extraction procedure of Li et al. (2007).

The procedure for pyrolysis at 550°C followed by hydrochloric acid extraction outlined by Li et al. (2007) is as follows.

1. Accurately weigh  $2 \pm 0.01$  g of a sample.
2. Place the dried solid in a crucible and roast it at 550°C (in a furnace) in an air atmosphere for 1 hour.
3. After cooling the roasted solid, transfer it to an extraction bottle; 80 mL of 4 M HCl is added and extracted for 30 min.
4. Filter the suspension through a 0.2  $\mu\text{m}$  membrane as described previously and analyze the extract by ICP after diluting it 10 times.
5. Wash the residue.
6. Transfer the filter with filter cake (solids residue) to a combustion boat.
7. Transfer combustion boats to a drying oven at 105°C for 2.5 to 3 hours. The samples must be completely dry to protect the analyzer.
8. Measure [residual] total sulphur with Leco induction furnace and automatic sulphur titrator (Section 12.3.1.1).

Note: The sulphur loss is determined from the difference in total sulphur in the sample before test and the residue after the extraction. Analysis of the extracted filtrate by ICP methods (or Atomic Absorption Spectrometry) analysis can be used to identify the concentration of chemical species dissolved by hydrochloric acid. Dilution is required to prevent hydrochloric acid interference with the ICP analysis.

### 12.4.3 Hot Sodium Carbonate

Boiling with 10% sodium carbonate is used to remove less soluble sulphate minerals, with the sulphate sulphur equal to the difference between total sulphur and residual sulphur. This method is adapted from the methods of ASTM E 1915 – 07a (2007) and Bucknam (1999).

1. Weigh  $0.25 \pm 0.01$  g < 200 mesh (< 74  $\mu\text{m}$ ) sample into a 150 mL beaker and record the weight.
2. Add 25 mL of 10% (w/v) sodium carbonate solution.
3. Cover the beaker with a watch glass and bring to gentle boil for 30 minutes.
4. Filter through a fine porosity glass micro filter (carbon content must be less than 0.15%, sulphur content must be less than 0.05% and the filter weight must be less than 0.2 g).
5. Wash with water at least two times, and then vacuum filter to remove excess wash solution from the filter cake.
6. Transfer the filter with filter cake (solid residue) to a combustion boat.
7. Transfer combustion boats to a drying oven at 105°C for 2.5 to 3 hours. The samples must be completely dry to protect the analyzer.
8. Measure [residual] total sulphur with Leco induction furnace (Section 12.3.1.1).

This method is suitable for samples containing approximately 0.02 to 5% sulphur. Material containing higher or lower concentrations can be analyzed with reasonable accuracy by adjusting the sample size taken for analysis.

According to Lapakko (2002), sodium carbonate will not dissolve barite, may only partially dissolve alunite and jarosite, but will partially dissolve the arsenic sulphides, orpiment and realgar.

### 12.4.4 Nitric Acid

Digestion with nitric acid is used as a measure of the concentration of sulphide-sulphur where the presence of significant organic sulphur will lead to significant errors in the calculation of sulphide-sulphur from total sulphur minus non-sulphide-sulphur. In the nitric acid digestion, the sample is boiled in a nitric acid solution to oxidize sulphide minerals and dissolve the resulting sulphate. Nitric acid will also dissolve any pre-existing acid leachable sulphate. Total sulphur analysis is conducted on the residue to measure the nitric acid insoluble sulphur.

$$\% \text{ sulphide-S} = [\% \text{ nitric acid insoluble-S}] \text{ minus } [\% \text{ HCl insoluble-S}]$$

The concentration of sulphide-sulphur (%) is calculated from the difference between the HCl insoluble-sulphur (Section 12.4.2) and the nitric acid insoluble-sulphur, based on the expectation that:

- nitric acid will oxidize and dissolve sulphide minerals and dissolve acid soluble sulphate minerals; and
- hydrochloric acid will dissolve acid soluble sulphate minerals and will not dissolve sulphide minerals.



Various problems have been found with nitric acid digestion. Studies of nitric acid digestion in the eastern USA had difficulty reproducing results (Kania, 1998) and it was found that the procedure frequently did not digest all the pyrite and therefore might underestimate the concentration of sulphide-sulphur (Stanton and Renton, 1981). Also, Tuttle et al. (1986) noted that dissolution of non-sulphide iron by nitric acid will result in an over estimation of the sulphide-sulphur or iron sulphide-sulphur, if the analysis of dissolved iron was used to identify the sulphide-sulphur or iron sulphide-sulphur content. Tuttle et al. (1986) also indicated that nitric acid might partially dissolve organically bound sulphur, potentially leading to an over estimation of the concentration of sulphide-sulphur.

#### 12.4.4.1 EPA-600 Method – Nitric Acid Method

This procedure is based on the procedures of Sobek et al. (1978), also known as EPA-600 Acid Base Accounting (ABA).

##### Chemicals

1. Nitric acid ( $\text{HNO}_3$ ), 1 part acid to 7 parts water: Mix 125 mL of concentrated  $\text{HNO}_3$  with 875 mL of distilled water.
2. Nessler's Solution (Fisher Scientific Co. No. So-N-24 or equivalent).

##### Materials

1. Funnels, 71.1 cm (28") I.D. polyethylene.
2. Filter paper, 14.0 cm (5.5") glass fibre.
3. Flasks, Erlenmeyer, 250 mL.
4. Beakers, 100 mL.
5. Balance, can be read to 0.001 g.

##### Procedure

1. Place 0.500 g sub-sample of less than 60 mesh material in a 250 mL Erlenmeyer flask. Note: Make sure all of the sub-sample is placed in the flask.
2. Add 50 mL of 12.5%  $\text{HNO}_3$  (1:7).
3. Let stand overnight at room temperature.
4. Taking care not to sharply crease the glass fibres, fold a filter to fit a polyethylene funnel.
5. Place a funnel holder over a sink or other suitable pan which can receive outflow from funnel.
6. Carefully pour the sub-sample and acid from the Erlenmeyer flask into the funnel. Note: Do not get material above the top of the filter paper.
7. Repeat step 6 using distilled and deionized water to wash all materials remaining in the Erlenmeyer flask into the funnel.
8. Place funnel holder containing funnel and sub-sample over a 100 mL beaker. Note: Stop here if procedure cannot be completed in one day. Caution: Sample must be kept moist.
9. Leach sub-sample with 50 mL of distilled and deionized water. Discard leachate.
10. Leach sub-sample with another 50 mL of distilled and deionized water.
11. Test the leachate for the presence of nitrates by adding 3 drops of Nessler's Solution with a dropper. Note: If nitrates are present, the leachate will turn yellow within 30 seconds as seen against a white background.

12. Discard leachate and repeat steps 9 and 10 until no nitrates are detected. Comment: It is necessary to remove chlorides and nitrates by water leaching after the nitric acid extraction and before running total sulphur.
13. Discard leachate.
14. Air dry the sub-sample and filter overnight.
15. Carefully fold glass fibre filter around the sample and transfer to a ceramic crucible.
16. Transfer the filter with filter cake (solids residue) to a combustion boat.
17. Transfer combustion boats to a drying oven at 105°C for 2.5 to 3 hours. The samples must be completely dry to protect the analyzer.
18. Measure [residual] total sulphur with Leco induction furnace and automatic sulphur titrator (Section 12.3.1.1).

The sulphur loss is determined from the difference in total sulphur before and after the extraction. Also, analysis of the extracted filtrate by ICP methods (or Atomic Absorption Spectrometry) analysis can be used to identify the concentration of chemical species extracted by hydrochloric acid.

#### 12.4.4.2 ASTM E 1915 – Nitric Acid Method

The ASTM E 1915 HNO<sub>3</sub> method differs from the Sobek method by increasing the nitric acid strength from 12.5 to 20% and boiling for 10 minutes. These revisions were made because the Sobek digestion conditions were found to be inadequate for hard rock pyrite (C. Bucknam, personal communication, 2008).

This method is adapted from the ASTM E 1915 07a (2007) method.

1. Weigh  $0.25 \pm 0.01$  g < 200 mesh (< 74  $\mu\text{m}$ ) sample into a 150 mL beaker and record the weight.
2. Add 25 mL of 1 part concentrated acid to 4 parts water (20% v/v) nitric acid in a beaker.
3. Let stand for 30 minutes.
4. Cover with a watch glass, place on a hot plate.
5. Gently boil for 10 minutes.
6. Remove from hot plate and cool.
7. Filter through a fine porosity glass micro filter (carbon content must be less than 0.15%, sulphur content must be less than 0.05% and the filter weight must be less than 0.2 g).
8. Wash with water at least two times and then vacuum filter to remove excess wash solution from the filter cake.
9. Transfer the filter with filter cake (solids residue) to a combustion boat.
10. Transfer combustion boats to a drying oven at 105°C for 2.5 to 3 hours. The samples must be completely dry to protect the analyzer.
11. Measure [residual] total sulphur with Leco induction furnace (Section 12.3.1.1).

This method is suitable for samples containing approximately 0.02 to 5% sulphur. Material containing higher or lower concentrations can be analyzed with reasonable accuracy by adjusting the sample size taken for analysis.

## 12.5 Calculations from Results of Solid Phase Elemental Analysis

Results from whole rock or near-total solid phase elemental analysis (Chapter 10) can be used to

*Results from whole rock or near-total solid phase elemental analysis can be used to calculate the maximum potential levels of sulphide and sulphate.*

calculate the maximum potential levels of sulphide and sulphate. This is done by assuming elements occur only as sulphide or sulphate minerals, including:

- Ag, As, Cd, Co, Cu, Hg, Mo, Ni, Pb, Sb, Sn and Zn as sulphide minerals; and
- Ba, Sr and Pb as acid insoluble and alkaline sulphate minerals.

Mineralogical information may indicate if trace elements occur in more than one mineral. Confirmation of the mineral form will be required if the mineral form is potentially important.

## 12.6 Recommended Approaches for Measurement of Sulphur Species

The decision about which procedures to conduct will depend on:

- the sulphur species present or expected;
- their potential contribution to acid generation, contaminant release or interference with the analysis of other sulphur species; and
- the required accuracy and precision.

The analytical procedures and calculations used to measure sulphur species will depend on the

*The large number of sulphur species and the limitations of the analyses in measuring one or more sulphur species preclude a single universal procedure.*

targeted species and the interference from other sulphur species. The large number of sulphur species coupled with the limitations of the

analyses in measuring individual forms of sulphur or sulphur minerals precludes a single universal procedure or sequence of procedures for estimating the concentration of different sulphur minerals or types of minerals.

The concentration of sulphur species in each geological unit should be regularly checked to identify which sulphur species require measurement and potential interferences with the measurement of sulphur species. Elemental analysis of the leachate, and elemental and mineralogical analysis of the residue is a good way to verify assumptions regarding the degree to which sulphur species are removed by roasting and wet chemical analyses. Wet chemical analyses may be used to identify sulphur species present in concentrations too small to be detected by XRD or petrographic analysis. The chemical composition of sulphur species should be checked to determine whether impurities are a potential source of problematic trace elements.

### 12.6.1 Initial Assessment of Sulphur Species and Selection of Analyses

The initial identification of potentially important sulphur species and fractions (e.g. iron sulphide species) used to select sulphur analyses for pre-development and operational material characterization should be based on the following:

- total sulphur analysis;

- water or EPA 600 cold hydrochloric acid leach indicating the concentration of soluble sulphate minerals;
- mineralogical analyses indicating the type and concentrations of different sulphur species;
- particle rinse pH or bedrock paste pH indicating the presence of conditions conducive to the occurrence of acidic sulphate species;
- whole rock or near-total solid phase elemental analysis indicating the maximum potential concentration of sulphide with Ag, As, Cd, Co, Cu, Hg, Mo, Ni, Pb, Sb, Sn and Zn and acid insoluble or alkaline sulphate with Ba, Sr and Pb; and
- the presence of organic matter or organic carbon indicating the presence of organic sulphur (Section 12.1.1.3).

The sulphur analyses selected for pre-development and operational material characterization may be selected from the above, or other selective roasting, wet chemical analyses and/or more detailed mineralogical analyses.

### 12.6.2 Total Sulphur

Measurement of total sulphur is typically needed in all phases of material characterization and prediction of drainage chemistry from sulphidic geologic materials.

Roasting at 1500 to 1700°C in a high temperature furnace is the standard total sulphur analysis (Section 12.3.1). Due to the speed and low cost of the technique, the recommended procedure is the Leco high temperature induction furnace analysis (Section 12.3.1.1).

Leco total sulphur analysis is typically the cheapest sulphur analysis and should be used to measure the quantity when only one sulphur species or fraction is present in significant concentrations.

### 12.6.3 Sulphide-Sulphur

The primary objective in estimating sulphide-sulphur is to calculate the potential acid generation by sulphide oxidation (Section 12.7). Sulphide-sulphur is most commonly measured directly by roasting, or indirectly by subtraction of sulphate-sulphur species from total sulphur.

Where sulphide is the only significant sulphur species present, the most cost-effective procedure is total sulphur determined by roasting with a Leco high temperature induction furnace (% sulphide-sulphur = % total-sulphur). This procedure should only be used after determining that the concentrations of other sulphur forms, such as organic or sulphate-sulphur, are insignificant. Where there are significant concentrations of non-sulphide-sulphur, total sulphur will substantially over estimate sulphide and the resulting estimate of the potential acid generation can result in unnecessary or excessive mitigation measures.

In the majority of unweathered rock types, the concentration of sulphate is relatively low and only becomes important where the potential for ARD is uncertain or the total sulphur is relatively low. However, there are many rock types where the concentration of sulphate is significant. The initial ARD predictions at Huckleberry Mine in British Columbia were based on the assumption that all sulphur occurred as pyrite, and thus total sulphur and sulphide-sulphur

were synonymous. In fact, a large proportion (up to 3% S) occurred in the non-acid generating forms of gypsum and anhydrite (calcium sulphates). As a result, the mine greatly exaggerated the acid generation potential (AP, Section 12.7), erroneously predicting that all Main Zone waste rock would be potentially net acid generating.

Where materials are organic sulphur free, the sulphide-sulphur content may be calculated from total sulphur minus sulphate-sulphur. Sulphate-sulphur is calculated from the cumulative total of the different sulphate fractions: highly soluble acidic and basic sulphates, moderately soluble basic sulphates, low solubility acidic sulphates and extremely insoluble sulphate minerals (Section 12.6.5).

*Where materials are organic sulphur free, the sulphide-sulphur content may be calculated from total sulphur minus sulphate-sulphur.*

Where the only significant sources of sulphur are sulphide minerals and basic sulphate minerals, total sulphur minus relatively soluble (primarily calcium sulphate) and acid insoluble (e.g. barite) sulphate is often an accurate and cost-effective measure of sulphide:

$$\% \text{ sulphide-S} = [\% \text{ total-S}] \text{ minus } [(\% \text{ leachable sulphate-S}) + (\% \text{ acid insoluble sulphate-S})]$$

Relatively soluble basic sulphate can be measured by extraction with water or a short, cold acid leach (Section 12.6.7). The potential concentration of acid insoluble sulphate can be initially estimated from the concentration of Ba, Pb and Sr (Section 12.6.9). Microprobe and XRD analyses can be used if more accurate estimates of the acid insoluble sulphate are required.

The calculation of sulphide-sulphur from total sulphur minus sulphate-sulphur may not apply for coal samples or samples including roots, woody debris, leaves, etc. Direct measurement of sulphide will be required where there are sources of non-sulphide-sulphur that cannot be accurately measured, such as organic sulphur. The loss of sulphur through pyrolysis may be the best estimate of sulphide, where the only significant sulphide minerals are iron sulphides and organic sulphur is not a significant constituent (ASTM E 1915, 2007). One or a combination of the various hydrochloric acid extractions, possibly in conjunction with the subtraction of some sulphate fraction, may be required if there are a variety of sulphide minerals present in significant concentrations (Section 12.6.4.3).

In neutral pH samples lacking acidic products of previous sulphide oxidation, sulphide plus any unidentified sulphur generally provide a conservative measure of AP, while avoiding large errors as a result of the inclusion of basic sulphates and organic sulphur.

Unidentified sulphur may include analytical error or unanalyzed species, such as elemental sulphur or alunite and other low solubility acidic sulphur species. Unidentifiable sulphur forms (“del-S”) should be treated as if it were sulphide-sulphur and included in the AP calculation (Section 12.7):

$$\text{Acid Potential (AP, as t CaCO}_3\text{equivalent/1000 t)} = (\text{sulphide-S (\%)} + \text{del-S (\%)}) * 31.25$$

It is important to keep in mind that the calculation of acid potential only from the sulphide content does not include the acid potential of secondary sulphates, particularly ferrous and ferric sulphates, that are present in some mine wastes.

### 12.6.4 Different Sulphide Species

The majority of sulphide-sulphur is usually iron sulphide minerals. Trace elements such as Ag,

*Trace elements such as Ag, As, Cd, Co, Cu, Hg, Mo, Ni, Pb, Sb, Se, Sn and Zn occur either as major structural elements of sulphides or trace constituents or impurities in iron sulphide minerals.*

As, Cd, Co, Cu, Hg, Mo, Ni, Pb, Sb, Sn and Zn occur either as major structural elements of sulphides or trace constituents or impurities in iron sulphide minerals.

The objectives in measuring the concentration of different forms of sulphide-sulphur and sulphide minerals include:

- identification of which trace elements are drainage chemistry concerns;
- degree to which sulphide-sulphur can be more or less acid generating than pyrite-sulphide at an acidic pH;
- the likelihood of differences in reaction rates due to differences in the reactivity of sulphide minerals and galvanic interaction between different sulphide minerals; and
- the degree to which sulphide-sulphur will be removed by different analytical methods.

#### 12.6.4.1 Calculations of Trace Element Sulphide-Sulphur from Solid Phase Elemental Analysis

Whole rock or near-total solid phase elemental analysis (Chapter 10) can be used to estimate the maximum possible sulphide associated with Ag, As, Cd, Co, Cu, Hg, Mo, Ni, Pb, Sb, Sn and Zn, assuming that the entire concentration of each occurs as a specific sulphide mineral.

Mineralogical information should be consulted to determine if non-sulphide forms of each element are likely. The trace element can be assumed to occur in its most common sulphide form where the identity of the sulphide mineral is unknown either because mineralogical data is not available or the detection limit is too high.

The formulae for calculating the concentration of sulphide-sulphur from elemental concentrations are as follows:

Covellite (CuS):

$$\% \text{ Cu} \times 32.07/63.54 = \% \text{ Cu-S}$$

Cu in Chalcocite (Cu<sub>2</sub>S):

$$\% \text{ Cu} \times 32.07/ (2 \times 63.54) = \% \text{ Cu-S}$$

Pentlandite (NiS):

$$\% \text{ Ni} \times 32.07/58.7 = \% \text{ Ni-S}$$

Galena (PbS):

$$\% \text{ Pb} \times 32.07/207.19 = \% \text{ Pb-S}$$

Sphalerite (ZnS):

$$\% \text{ Zn} \times 32.07/65.37 = \% \text{ Zn-S}$$

Arsenopyrite (FeAsS)<sup>9</sup>:

$$\% \text{ As} \times 32.07/74.92 = \% \text{ As-S}$$

Molybdenite (MoS<sub>2</sub>):

$$\% \text{ Mo} \times (2 \times 32.07)/95.94 = \% \text{ Mo-S}$$

These calculations indicate that trace element concentrations less than 150 ppm will typically result in less than 0.01% sulphide-sulphur.

Whole rock or near-total solid phase elemental analysis (Chapter 10) can not be used to estimate the maximum possible concentration of iron sulphide minerals and sulphide-sulphur when iron also occurs in other major and minor minerals, such as biotite, chlorite and hematite.

#### 12.6.4.2 Mineralogical Analysis

Petrographic analysis will indicate the major and minor sulphide species and their distribution in areas of bedrock that are likely to contribute differently to the reactive fine products. Rietveld analysis of XRD data will measure the proportion of different sulphide minerals.

Detailed sub-microscopic analysis of the percentage of Ag, As, Cd, Co, Cu, Hg, Mo, Ni, Pb, Sb, Se, Sn and Zn that occurs (1) in different sulphide minerals and (2) as sulphide instead of other minerals (e.g. sulphates, silicates, oxides and carbonates) should be conducted where these properties will significantly affect the predicted contaminant concentrations or AP and NPR.

Sub-microscopic techniques, such as electron microprobe, quantitative SEM-EDS or some equivalent measurements can be used to determine the proportion of Ag, As, Cd, Co, Cu, Hg, Mo, Ni, Pb, Sb, Se, Sn and Zn in different minerals. XRD or point counting with image analysis will allow accurate estimates of the percentage of the different minerals containing Ag, As, Cd, Co, Cu, Hg, Mo, Ni, Pb, Sb, Se, Sn and Zn. Mineralogical analyses used to measure sulphate minerals are discussed in Chapter 17.

#### 12.6.4.3 Selective Extraction

Pyrolysis and wet chemical extraction may be used to quantify iron and trace element sulphide minerals whose volatility differs from other sulphur species in a sample. The leach solution used in chemical extraction will depend on the targeted sulphide species and the potential interference from other sulphur species. Analysis of the leach solution following wet chemical extraction may be used to estimate concentrations of extracted trace element sulphide minerals. Some properties with regards to different selective extractions that may be useful in quantifying different sulphide minerals are as follows.

Pyrite is removed by roasting at 550°C for 1 hour and the hydrochloric acid / chromium extraction, but is unaffected by a hydrochloric acid extraction.

The majority of pyrrhotite (86 to 88%) is removed by roasting at 550°C for 1 hour or with a hot hydrochloric acid extraction. Pyrrhotite is completely removed by roasting at 550°C for 1 hour followed by a 30 minute cold hydrochloric acid extraction.

---

<sup>9</sup> Note that in arsenopyrite, As occurs as a non-metal, like S, and not as a metal.

Arsenopyrite is removed by roasting at 550°C for 1 hour, but is unaffected by a hot hydrochloric acid extraction and less than 10% is removed by a hydrochloric acid / chromium extraction.

The combination of hot hydrochloric acid extraction and hydrochloric acid / chromium extraction removed approximately 50% of the orpiment and 80% of the realgar.

Copper sulphide minerals including chalcopyrite, bornite, covellite, and chalcocite are only

*The copper sulphide minerals including chalcopyrite, bornite, covellite, and chalcocite are only partially removed by cold hydrochloric acid, roasting and hot hydrochloric acid.*

partially removed by cold hydrochloric acid, roasting and hot hydrochloric acid. The relative removal is: cold hydrochloric acid < roasting at 550°C for 1 hour < hot hydrochloric acid). For the minerals tested, roasting at 550°C for 1 hour followed by

extraction for 30 minutes in cold hydrochloric acid leads to 100% removal. Bornite and chalcopyrite appear to have both mono and disulphide properties and were recovered most effectively by sequential extraction with hot hydrochloric acid followed by hydrochloric acid / chromium. Stannous chloride enhanced the removal of these two sulphides by hot hydrochloric acid.

Molybdenite is highly refractory in hydrochloric acid and hydrochloric acid / chromium treatments and only dissolves under highly aggressive conditions (e.g. HNO<sub>3</sub> boiled to dryness) (Chao and Sanzalone, 1977).

Galena can be completely removed by hot hydrochloric acid, and was 76% soluble in a 16 hour cold hydrochloric acid extraction. Only 1% galena was removed by roasting at 550° C for 1 hour, while roasting at 550°C for one hour followed by cold hydrochloric acid removed 95%.

Sphalerite can be completely removed by hot hydrochloric acid, but only 24% was removed by a 16 hour cold hydrochloric acid extraction. Only 5% was removed by roasting at 550°C for 1 hour, while 38% was removed by cold hydrochloric acid after roasting at 550°C for 1 hour.

Pentlandite is largely removed by hot hydrochloric acid and relatively insoluble in cold hydrochloric acid. About 50% of pentlandite is removed by roasting at 550°C for 1 hour and 70% is removed by roasting at 550°C for 1 hour followed by a cold hydrochloric acid extraction.

### 12.6.5 Sulphate Fractions and Species

Sulphate species can be a source of acidity, major cations, sulphate and potentially harmful trace elements and are used to estimate the concentration of other sulphur species. Thus, the measurement of their concentrations and compositions are important for geochemical characterization, prediction of drainage chemistry and interpretation of field monitoring and kinetic test work results. Major categories of sulphate species include:

- highly soluble basic sulphates, such as sodium and magnesium sulphate;
- highly soluble acidic sulphates, such as melanterite;
- moderately soluble basic sulphates, such as the calcium sulphates, gypsum and anhydrite;
- low solubility acidic sulphates such as the hydroxy iron and aluminum sulphates including jarosite and alunite; and
- extremely insoluble sulphate minerals such as barite and anglesite.



Mineralogical, total element and/or extraction procedures needed to measure the concentration and composition of sulphate species will depend on the sulphate species and information required. Quantitative mineralogical analysis used to measure the composition of different sulphate minerals, including the concentration of minor and trace element impurities are discussed in Chapter 17.

### 12.6.6 Highly Soluble Basic and Acidic Sulphates

Highly soluble basic sulphates, such as magnesium and sodium sulphates, and acidic sulphates,

*Highly soluble basic sulphates, such as magnesium and sodium sulphates, and acidic sulphates, such as hydrated iron and aluminum sulphates, are extractable in water.*

such as hydrated iron and aluminum sulphates, are extractable in water. Measurement of the chemical composition of the water after the extraction can indicate their concentration and elemental

composition, so long as there are no other sources for their constituents.

An acidic particle rinse pH will indicate conditions conducive to the occurrence of acidic sulphate species. Measurement of aqueous acidity after the extraction can indicate the potential release of acidity from these sulphate minerals, so long as there are no other major sources of acidity or alkalinity. Major alkalinity, for example, can result from sample pretreatment that exposes or otherwise increases the leachability of lower solubility or physically occluded minerals.

The small particle or grain size coupled with possible damage during slide production, may make these sulphates undetectable by petrographic analysis. These species may be poorly ordered and present in trace amounts, also making detection difficult by XRD. Thus, sub-microscopic procedures may be needed for identification and quantification, and measuring their composition (Chapter 17).

### 12.6.7 Moderately Soluble Basic Sulphates

Moderately soluble basic sulphates, such as the calcium sulphates, gypsum and anhydrite, can be measured by extraction with water or cold hydrochloric acid. The contribution and interference in the analysis by less soluble sulphates or relatively soluble sulphates can increase if the extraction is conducted for longer periods of time or with hot hydrochloric acid. More aggressive hydrochloric acid extractions will not be appropriate for measuring sulphate-sulphur where pyrrhotite and other acid volatile sulphide species are present.

Concentrations of calcium sulphate greater than approximately 0.2% can often be measured with XRD and detected in thin sections.

Water or EPA 600 cold hydrochloric acid leach can detect relatively small, but highly or moderately soluble, environmentally significant concentrations of sulphur species that XRD, petrographic and visual mineralogical techniques may not detect. More detailed sub-microscopic mineralogical characterization may be required to identify the composition of amorphous sulphur species (Chapter 17).

### 12.6.8 Low Solubility Acidic Sulphates

The presence of low solubility acidic sulphates may be suspected where weathered or hydrothermally altered sulphidic geological materials have a rinse or whole rock abrasion  $\text{pH} < 6$ . However, a  $\text{pH} > 6$  after the rock is ground in water does not imply the absence of jarosite or alunite. Neither jarosite nor alunite are rapidly soluble in water at relatively low temperatures ( $< 50^\circ\text{C}$ ), and a short duration abrasion test likely would not result in the dissolution of these minerals, with a resultant effect on the pH. A near-neutral or alkaline paste pH may result from carbonate in areas (e.g. veins or in groundmass) physically occluded and thus unaffected by the localized hydrothermal alteration that produced low solubility hydroxyl sulphate minerals (e.g. alunite phase of hydrothermal alteration).

Low solubility acidic iron sulphates, such as jarosite, can be identified petrographically or visually by their distinct yellow and red colour (Section 8.10).

A number of selective extraction procedures have been proposed to remove hydroxyl iron and aluminum sulphate species. These include dissolution of jarosite in hot hydrochloric acid (Tuttle et al., 2003), cold hydrochloric acid following roasting (Li et al., 2007), sodium carbonate (ASTM 1915-07a, 2007) and sodium hydroxide (Yin and Catalan, 2003).

Potential concerns with the use of selective extraction include the wide range in composition of acidic sulphate minerals, the limited number of species previously studied, and the potential interference from other sulphur species. Lower solubility hydroxyl sulphates, such as the alunite-jarosite group, have a diverse composition and reactivity (Lapakko, 2002). Thus, sub-microscopic mineralogical analysis, such as scanning electron microscopy, energy dispersive spectroscopy or electron microprobe analysis, should be conducted to assist in the determination of the:

- mineral species and composition;
- potential acid generation per mole of sulphate-sulphur;
- potential acidity and trace element release; and
- effectiveness of selective extraction procedures in removing low solubility acidic sulphates.

### 12.6.9 Extremely Insoluble Sulphate Minerals

The extremely insoluble sulphate minerals barite ( $\text{BaSO}_4$ ) and anglesite ( $\text{PbSO}_4$ ) may control the corresponding aqueous concentrations of barium and lead and attenuate or release radium. However, due to their low solubility and extractability, if present in sufficiently high concentrations barite and anglesite can interfere with the results of procedures that calculate forms of sulphur from the difference between total sulphur and extractable sulphur. For example, barite-S will report as sulphide-S if hydrochloric acid insoluble sulphur is used to predict the % sulphide-sulphur.

*Despite their low solubility and extractability, barite and anglesite can significantly interfere with the results of some procedures for estimating sulphide-sulphur and the acid generation potential.*

Barite and anglesite are usually present in concentrations too low to be a concern. However, an estimate of their concentration and whether it will impact the measurements is needed for the selection of analytical procedures, and to decide whether a correction factor is required in the interpretation of the results. The interference of barite, anglesite and celestite with the estimation of % sulphide-sulphur or acidic sulphate minerals will usually only significantly affect the AP and NPR if the % sulphide-sulphur and NP are low and the concentration of barium, lead and/or strontium is relatively high.

The estimation of concentrations of barite and anglesite and their potential interference on analytical procedures and results can be conducted in two steps:

1. Calculation of the maximum potential concentrations of barite+anglesite-sulphur assuming all measured barium and lead from whole rock or near-total solid phase elemental analysis occur as barite and anglesite; and
2. Sub-microscopic analysis of the concentrations of barite and anglesite and the proportions of solid phase barium and lead that occur in these minerals.

#### 12.6.9.1 Calculations from Results of Solid-Phase Elemental Analysis

Sensitivity analysis of the potential interference of barite and anglesite can be conducted by:

- calculating the maximum potential combined concentrations of barite+anglesite-sulphur from the whole rock or near-total solid phase elemental concentrations of barium and lead; and
- comparing the results with the concentrations of sulphide-sulphur and the neutralizing potential.

The calculations of % barite-S and % anglesite-S from % barium, and % lead, based on the ratio of their molecular weight to that of sulphur and the assumption that these minerals are the only source for these elements are as follows:

$$\begin{aligned} \% \text{ Ba} \times (32.07/137.34) &= \% \text{ barite-S} \\ \% \text{ Pb} \times (32.07/207.19) &= \% \text{ anglesite-S} \end{aligned}$$

The percentage and concentration (ppm) of barium and lead needed to produce 0.01% barite and anglesite is as follows:

$$\begin{aligned} 0.01\% \text{ barite-S} &\text{ contains } 0.044\% \text{ or } 442.8 \text{ ppm Ba} \\ 0.01\% \text{ anglesite-S} &\text{ contains } 0.064\% \text{ or } 646.1 \text{ ppm Pb} \end{aligned}$$

#### 12.6.9.2 Sub-microscopic Analysis of % Ba and Pb in Different Minerals

Detailed sub-microscopic analysis (Chapter 17) of the proportion of barium and lead that occurs as sulphate compared to other minerals (e.g. Pb may also occur in galena and Ba may occur in various silicates, oxides and carbonates) should be conducted to more accurately determine the barite-sulphur and anglesite-sulphur, if interference by the maximum potential concentrations (Section 12.6.9.1) significantly affects the predicted AP, NPR and drainage chemistry.

*An example of a more detailed assessment of the contribution of % Ba-sulphate-sulphur to the % sulphide-sulphur is the work done by the Kemess mine in British Columbia on their oxidized, leach cap waste rock. The oxidized, leach cap contained low % sulphide-sulphur (0.01-0.12%) and NP (50% < 10 kg/t) and sufficiently elevated Ba (0.087-0.348%) to potentially impact the portion of waste rock predicted to have a potential to produce ARD. The concentrations of Pb were too low to be of significance.*

*Results from the mineralogical studies were as follows:*

- *petrographic analysis was unable to detect the small barite grains.*
- *SEM/EDS work indicated the pervasive presence of small (< 5 µm) barite particles throughout the waste rock.*
- *Rietveld XRD indicated that the mineral wt% was 25-35% muscovite, 6-10% illite, 47-55% quartz, 4-9% hematite and 3-9% kaolinite. The wt% for muscovite plus illite was 33-40%*
- *electron microprobe analysis indicated:*
  - *the only minerals in addition to barite with detectable % Ba (> 0.07 wt.) were muscovite and illite; and*
  - *Ba from muscovite + illite was 0.07-0.10% and 47-71% of the total Ba.*
- *assuming 25% of the Ba occurred as barite in the ABA calculations they would have no significant impact on the portion of the oxidized, leach cap waste rock predicted to have a potential to produce ARD.*

*Additional observations from the Kemess prediction work were that:*

- *electron microprobe analysis provides results comparable to those from whole rock elemental analysis after lithium borate or peroxide fusion, rather than a less complete digestion that might not measure the Ba in coarse grained silicates or other less digestible minerals;*
- *blasting exposed sulphide grains that were physically occluded and protected from oxidation within the rock mass; and*
- *the drainage from the oxidized, leach cap waste rock will release elevated concentrations of selenium under neutral pH weathering and leaching conditions.*

Sub-microscopic techniques, such as electron microprobe analysis, quantitative SEM-EDS or some equivalent measurement can estimate the proportions of barium and lead in different minerals.

XRD or point counting with image analysis can provide the percentage of the different minerals containing barium and lead.

## 12.7 Acid Generation Potential

The term “acid generation potential” (AP) refers to the total acid ( $H^+$  equivalent) a material is capable of producing irrespective of its fate. The acid generated can remain in solution, precipitate as acid salts, be neutralized, converted to other forms of acidity or lost through leaching. Acid salts can dissolve, releasing acid at a later time. Acid generation should not be confused with the generation of

*The term “acid generation potential” (AP) refers to the total acid ( $H^+$ ) a material is capable of producing irrespective of its fate.*

acidity (Chapter 5) or the generation of acidic drainage. The generation of acidic drainage or ARD requires acid generation to exceed acid neutralization (Chapters 13 and 14). The term acid generation potential is often shortened to acid potential or the acronym AP.

The acid generation potential is primarily used in conjunction with NP to estimate the potential future net drainage pH of presently near-neutral or alkaline samples in Acid Base Accounting (ABA). The AP can also be used to estimate the potential amount of acid residing in acidic sulphates and sulphides in already net acidic material.

The sources of acid, the weathering conditions, whether they are measured or assumed and the analytical procedures used to derive the AP should be clearly identified. Unless otherwise specified, the assumption is that acid generation occurs under oxidizing conditions, without time constraints and regardless of the fate of the acid or the resulting pH of the pore water.

Acid generation potential (AP) should be reported in units of kg of CaCO<sub>3</sub> equivalent/ tonne to enable a comparison with the acid neutralization potential (NP). Other common units, which are identical to kg/t, are tonnes (t) of CaCO<sub>3</sub> equivalent/1000 t of sample and parts per thousand (ppt) CaCO<sub>3</sub> equivalent.

### 12.7.1 Sources of Acid

The primary sources of acid generation in sulphidic geologic materials (Chapter 5) are:

- oxidation of sulphide minerals;
- dissolution of acidic -sulphate minerals; and
- hydrolysis of metals from sulphide and sulphate minerals.

Acid consuming oxidation is generally required prior to the hydrolysis where metals such as iron occur as reduced species in sulphide and sulphate minerals (Chapter 5). Acidic sulphate minerals can be products of previous sulphide oxidation.

Other less common and typically smaller, but depending on the size of other acid sources and the rate of acid neutralization, potentially significant sources of acid include:

- oxidation of intermediate sulphur species, such as elemental sulphur and thiosalts;
- dissolved acidity;
- oxidation of ammonium from blasting powder, fertilizer and cyanide decomposition;
- exchangeable acidity and organic acids from acidic soils;
- precipitation; and
- groundwater and runoff.

The decreasing pH of the water cover on the tailings at the Equity Silver mine in British Columbia was attributed to the oxidation (nitrification) of ammonium produced by cyanide decomposition (Reaction 12.1).



Naturally acidic soils include acid sulphate soils (Ahern et al., 2004) and acid soils resulting from the partial decomposition of organic matter under cool climatic conditions. Organic acids resulting from the partial decomposition of organic matter under cool climatic conditions can produce drainage with pH values less than 4. Acidic organic material may contribute acid through decomposition, the migration of organic acids or from the displacement of  $H^+$  on exchange sites by other cations.

Acidity in groundwater and runoff can result from drainage from some other project components, off-site anthropogenic activities and natural processes. Sulphidic country rock used for construction was the first source of acidic drainage at the Greens Creek mine in Alaska. Also, construction of roads and drill pads may have contributed to the acidic runoff that lowered the drainage pH at the base of the Sulphurets waste rock dump in British Columbia (Price, 2005). Accelerated NP depletion and ARD onset due to the increased solubility of carbonate minerals has also been observed where waste rock was used as fill in areas with a fluctuating water table at the neighbouring Johnny Mountain mine (Price and Yeager, 2004).

*Sulphidic country rock used for construction was the first source of acidic drainage at the Greens Creek mine in Alaska.*

### 12.7.2 Estimation of Acid Potential in Acidic Sulphate Minerals

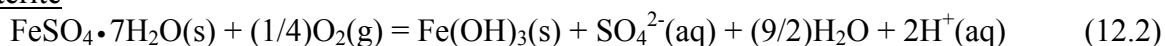
The content of acid producing sulphates needs to be considered to properly assess the acid potential of a sample. Under acidic conditions, significant potential acidity may reside in acid sulphate minerals. In net near-neutral and alkaline sulphidic geologic materials, localized weathering or hydrothermal alteration may have produced low solubility hydroxyl sulphate minerals (Section 12.6.8).

The amount of acid ( $H^+$  equivalent) produced per mole of sulphur by sulphate dissolution will depend on the subsequent reaction products of the acidic cations and the relative charge of the base cations. The potential acid generation expressed as kg  $CaCO_3$  eq/tonne from the dissolution of sulphate minerals, containing only acidic cations and with complete metal hydrolysis, exchange, precipitation or complex formation, can be calculated from the % sulphate-sulphur as follows:

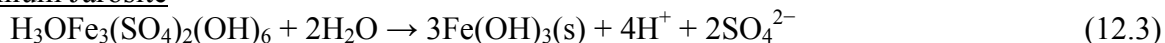
$$AP \text{ (kg/t)} = \% \text{ sulphate-sulphur} \times 31.25$$

This calculation is based on the following reactions in which two moles of acid ( $H^+$ ) are produced per mole of sulphate-sulphur.

#### Melanterite



#### Hydronium Jarosite

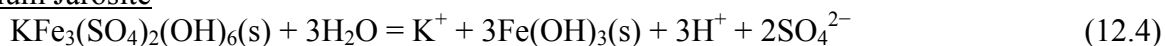


The potential acid generation, expressed as kg  $CaCO_3$ /tonne, from the dissolution of sulphate minerals containing a base cation, such as sodium or potassium jarosite, expressed as kg  $CaCO_3$  eq/tonne, can be calculated from the % sulphate-sulphur as follows:

$$AP = \% \text{ sulphate-sulphur} \times 31.25 \times 0.75$$

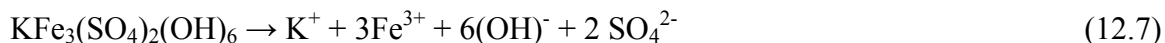
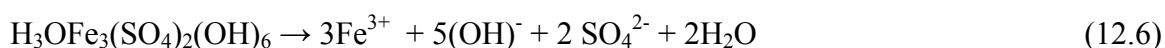
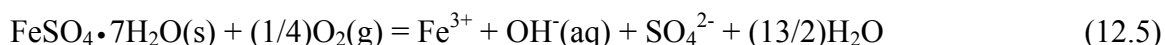
This calculation is based on the following reaction in which the base becomes a free ion and 1.5 moles of  $H^+$  are produced per mole of sulphate-sulphur.

### Potassium Jarosite



#### 12.7.2.1 Conditions that Reduce Acid Generation

Reduction in the pH and other weathering conditions that reduce Fe and Al hydrolysis or other acid generating reactions of the Fe and Al released by sulphate dissolution will reduce the acid ( $H^+$ ) generation per molar unit of sulphate-sulphur. For example, acidic sulphate dissolution may consume acid or produce no acid where all the Fe and Al remains dissolved as free ions:



#### 12.7.2.2 Analyses

A number of selective extraction and sub-microscopic mineralogical procedures can be used to estimate the concentration of different acidic sulphate species (Section 12.6). With selective extraction, there are concerns with potential interferences from other sulphur species. Additional analyses are needed to determine the mineral species, elemental composition, potential acid generation per mole of sulphate-sulphur and the effectiveness of selective extraction procedures in removing low solubility acidic sulphate.

The AP from the dissolution of highly soluble acidic sulphate minerals can be estimated from the acidity dissolved in water with a water to solid ratio that exceeds the solubility limits of the acid salts (Sections 12.4.1 and 12.6.6).

### 12.7.3 Acid Generated by Sulphide Oxidation

Under all aerobic weathering conditions, significant potential acid may reside in sulphide minerals. Under near-neutral and alkaline conditions, the potential for future mineral acid generation consists almost entirely of acid from sulphide oxidation and can usually be calculated from the sulphide-sulphur content.

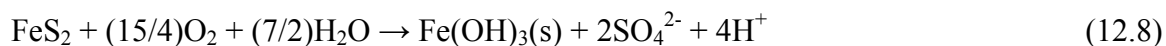
*Under all aerobic weathering conditions, significant potential acid may reside in sulphide minerals.*

The amount of acid ( $H^+$  equivalent) produced per mole of sulphur by sulphide oxidation reactions will depend on the composition of the sulphide mineral and the subsequent reaction products. The potential acid generation expressed as kg  $CaCO_3$  equivalent/tonne for sulphide oxidation with complete metal hydrolysis or some equivalent metal reaction product, can be calculated from the % sulphide-sulphur as follows:

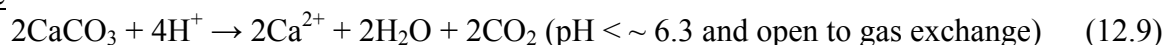
$$AP \text{ (kg/t)} = \% \text{ sulphide-sulphur} \times 31.25$$

This calculation is based on the following reactions in which 2 moles of  $H^+$  are produced per mole of sulphide-sulphur and each mole of calcite neutralizes 2 moles of  $H^+$ .

#### Pyrite



#### Calcite



The conversion factor of 31.25 is derived from:

$$\frac{(2 \times \text{molecular weight of calcite} / 2 \times \text{molecular weight of sulphur in pyrite}) \times (10)}{(2 \times 100 / 2 \times 32) \times 10}$$

Ten is the conversion from % to kg/tonne.

The assumption that all the sulphide-sulphur will behave like iron sulphide minerals and, at near-neutral pH, oxidation will produce 2 moles of acid ( $H^+$ ) per mole of sulphur is generally valid because iron sulphide minerals are usually present in much higher concentrations than other sulphide minerals. However, this is not always the case. Also, above pH 6, calcite can become less effective per mole at neutralizing acid.

Non-iron sulphide minerals can be categorized as:

- those whose oxidation will release metal cations; Ag, Cd, Co, Cu, Ni, Pb and Zn; and
- those that form anions and potentially generate more than 2 moles of acid ( $H^+$ ) per mole of sulphur, like As, Mo, Sb and Se.

Differences from iron sulphide minerals in the composition and the proportion of reaction products that remain dissolved as free ions may alter the moles of acid ( $H^+$ ) generated per mole of sulphide-sulphur from that of Equation 12.8 (Chapter 5). Whether more or less acid is produced will depend on whether the non-iron sulphide generates free cations or anions. It is therefore important to check the concentrations of non-iron sulphide minerals and consider whether differences in the production of acid may affect whether presently near-neutral materials will become net-acidic.

#### 12.7.3.1 Acid Generation by Non-Iron Sulphide Species Generating Metal Cations

The oxidation at near-neutral and alkaline pH of non-iron sulphide minerals releasing metal cations in general can generate:

- the same two moles of acid ( $H^+$ ) per mole of sulphur if there is complete metal hydrolysis, exchange, precipitation or complex formation; or
- no acid ( $H^+$ ) per mole of sulphur if the cations remain as free ions.

For example, the oxidation of ZnS to dissolved  $Zn^{2+}$  and  $SO_4^{2-}$  can produce zero moles of acid ( $H^+$ ) if the zinc remains in solution as a free, dissolved ion. Nearly complete hydrolysis, exchange, precipitation or complex formation is

*For example, the oxidation of ZnS into dissolved  $Zn^{2+}$  and  $SO_4^{2-}$  can produce zero moles of acid if the zinc remains in solution as a free, dissolved ion.*



expected for Cu and Pb, but a significant portion of Ag, Cd, Co, Ni and Zn may remain as free ions.

### 12.7.3.2 Acid Generation by Non-Iron Sulphide Species Generating Anions

The oxidation at near-neutral and alkaline pH of non-iron sulphide minerals releasing anions in general can generate:

- the same two moles of acid ( $H^+$ ) per mole of sulphur if there is complete anion exchange, precipitation or complex formation; or
- three or four moles of acid ( $H^+$ ) per mole of sulphur if the anions remain as free ions.

Production of free anions of Mo and Se can generate three moles of acid ( $H^+$ ) per mole of sulphur, and production of free anions of As and Sb can generate four moles of acid ( $H^+$ ) per mole of sulphur. For example, the oxidation of  $MoS_2$  to dissolved  $MoO_4^{2-}$  and  $SO_4^{2-}$  can produce three moles or 50% more acid ( $H^+$ ) per mole of sulphur. The oxidation of  $FeAsS$  into dissolved  $HAsO_4^{2-}$  and  $SO_4^{2-}$  and precipitated  $Fe(OH)_3$  can produce four moles or 100% more acidity ( $H^+$ ) per mole of sulphur.

### 12.7.3.3 Preliminary Assessment of Impact of Non-Iron Sulphide on the Acid Potential

A preliminary assessment of the impact of non-iron sulphide minerals on the acid potential and the NPR should include determination of the following.

1. Whole rock or near-total solid phase analyses of Ag, As, Cd, Co, Cu, Hg, Mo, Ni, Pb, Sb, Se, Sn and Zn can be used to calculate the maximum possible concentrations of sulphide-S associated with these elements (Section 12.6.4.1).
2. The total concentrations of non-iron sulphide-sulphur that may decrease (e.g. Ag, Cd, Co, Ni and Zn) or increase (e.g. As, Mo, Sb and Se) the moles of acid ( $H^+$ ) produced per mole of sulphur at near-neutral and alkaline pH should be calculated separately.
3. The maximum potential increase or decrease in acid produced can be calculated by assuming:
  - no moles of acid produced by Ag, Cd, Co, Cu, Ni, Pb and Zn; and
  - three moles of acid produced by Mo and Se and four moles of acid produced by As and Sb.
4. The impact of the maximum potential increase or decrease in the acid potential and the NPR should be used to determine whether a more refined assessment of the non-iron sulphide minerals is warranted.

#### 12.7.3.4 More Refined Assessment of Impact of Non-Iron Sulphide on the Acid Potential

Where the preliminary assessment indicates that differences in the acid produced by non-iron sulphide minerals from two moles of acid per mole of sulphide-sulphur may affect whether presently neutral materials will become net-acidic, a more refined evaluation should be conducted on the:

- concentration of non-iron sulphide minerals;
- proportion of the trace elements that form soluble complexes or precipitates as sulphates, hydroxides, oxides and carbonates; chelate; adsorb and co-precipitate; and
- speciation of released trace elements that become dissolved ions.

Quantitative mineralogical analysis is required to accurately measure the concentration and composition of the different sulphide minerals, including the concentration of minor and trace element impurities occurring in the lattice or as inclusions in iron sulphide minerals (Chapter 17).

The precipitation, chelation, adsorption, co-precipitation and the speciation of dissolved trace elements depend on a large number of drainage and solid properties. One option for considering all these properties in the prediction of future acid generation is to conduct speciation and mineral equilibrium modeling using computer codes such as MINTEQA2 (U.S. EPA) and PHREEQC (U.S. Geological Survey), ideally in conjunction with site-specific data (Chapter 20). Where site-specific data does not exist, simulations should be run for a range of plausible drainage chemistries. In the absence of site or element specific drainage pH criterion, the assessment should be done for a drainage pH of 6, the transition from near neutral to acidic pH.

*Where site specific data does not exist, simulations should be run for a range of plausible drainage chemistries.*

#### 12.7.4 Correction for Differences between Effective Field and Measured AP

Possible differences between effective field and laboratory measurements of AP that may warrant corrections, in a similar manner to corrections made to the acid neutralization potential (NP, Chapter 13), are as follows:

- concentration during deposition;
- physical occlusion;
- limiting weathering and drainage chemical condition; and
- slow reaction rate (kinetically limited).

Corrections will only be required if the properties and processes disproportionately affect the acid generation potential (AP) and acid neutralization potential (NP).

##### 12.7.4.1 Concentration during Tailings Deposition

Sandy material that settles near a tailings discharge point may be:

- better drained, resulting in higher rates of air entry and oxidation; and
- contain higher concentrations of heavy minerals like sulphides resulting in a disproportionate increase in the concentration of AP.

The finer slimes closer to the center of an impoundment may have a disproportionate lower AP concentration and a higher amount of lighter carbonate minerals. Also, due to their particle size (silt size), they are more likely to remain saturated.

#### 12.7.4.2 Physical Occlusion

Physical occlusion in walls or coarse fragments and beneath surface coatings that prevent weathering processes will prevent minerals from generating acidity.

Acid generating or neutralizing minerals disproportionately occurring in veins and on fractures are likely to preferentially report to the finer sized particles of waste rock or occur on wall surfaces. Preferential occurrence of acid generating minerals in finer sized particles or on wall surfaces will result in more reactive surface area per unit weight and may result in an effective NPR that is lower than the overall NPR. This is a concern in waste rock, where the fines (< 2 mm grains) will be almost entirely exposed to oxygen and water, while most of the minerals in coarse fragments are occluded and unable to react. Often the NPR of the reactive fines is significantly lower than that predicted from a “whole waste rock” ABA. However, the opposite also occurs.

Sulphide minerals may be physically occluded by surface coatings or inclusion in other minerals such as quartz. Coatings observed in bedrock may be partially removed during deposition of waste rock and during crushing and grinding of tailings. Cemented layers deposited after weathering may be altered by changing weathering or environmental conditions, such as wetting and drying or a change in the pH or redox potential.

#### 12.7.4.3 Weathering and Leaching Conditions

Weathering and drainage conditions affecting acid generation reactions and reaction products can have a large effect on the rate of acid production. For example, under near-neutral or alkaline pH conditions, a lack of oxygen will prevent acid generation by sulphide oxidation. At a pH < 3.5, sulphide may be oxidized by dissolved ferric iron in drainage migrating from regions containing oxygen, but a lack of oxygen will generally prevent the oxidation of ferrous to ferric iron.

Weathering conditions also have a large impact on the degree to which reaction products remain as free ions and therefore on the number of moles of acidity generated per mole of oxidized sulphide-sulphur or dissolved acid sulphate-sulphur. The type and proportion of complex formation, hydrolysis, chelation and precipitation of released ions control the number of moles of acid produced. For example, there is less hydrolysis of iron at a pH < 3.5 and the oxidation of ferrous to ferric iron will consume acid. This results in reduced acid production by the oxidation of pyrite and marcasite, no net acid production by the oxidation of chalcopyrite and net acid consumption by the oxidation of pyrrhotite.

Therefore, the need to correct for differing weathering and leaching conditions will depend on the AP reaction mechanisms and products.

#### 12.7.4.4 Precipitation of Acidic Sulphate Minerals

Precipitation of acidic sulphate minerals will store acidity, removing it from solution until they dissolve. The type and nature of precipitating sulphate minerals will depend on the drainage chemistry. For example, incomplete iron oxidation and concentrations of ferrous iron and sulphate exceeding the solubility limits will result in the precipitation of hydrous ferrous sulphate minerals, such as melanterite. Precipitation of these sulphates will retain two moles of stored acidity per mole of sulphate-sulphur. Incomplete hydrolysis of ferric iron and a pH below 3.5 may result in the precipitation of jarosite  $[\text{KFe}_3(\text{SO}_4)_2(\text{OH})_6]$ , storing one mole of acidity per mole of iron and 1.5 moles of acidity per mole of sulphate-sulphur.

*Precipitation of acidic sulphate minerals will store acidity, removing it from solution until they dissolve.*

#### 12.7.4.5 Slow Reaction Rates

Reaction rates may affect the significance of acid generating or storing reactions. One example of this is the dissolution rates of some acidic sulphate minerals, such as alunite and jarosite. These may be so slow under some geochemical conditions that their rate of acid generation is negligible.

## 12.8 References

- Ahern, C.R., A.E. McElnea and L.A. Sullivan. 2004. Queensland Acid Sulfate Soils Technical Manual. Laboratory Methods Guidelines 2004-Acid Sulfate Soils. Queensland Department of Natural Resources, Mines and Energy, Indooroopilly, Queensland, Australia. pp. 1-150.
- ASTM E 1915 – 07a. 2007. Standard Test Methods for Analysis of Metal Bearing Ores and Related Materials by Combustion Infrared-Absorption Spectrometry. p. 14.
- Brady, N.C. 1990. The Nature and Properties of Soils. 10th Edition. Macmillan Publishing Company. p. 622.
- Bucknam, C.H. 1999. NMS Analytical Methods Book, Newmont Metallurgical Services.
- Canfield, D.E., J.T. Raiswell, C.M. Westrich, C.M. Reaves and R.A. Berner (1986). The Use of Chromium Reduction in the Analysis of Reduced Inorganic Sulphur in Sediments and Shales. Chem. Geol. 54: 149-155
- Chao, T.T. and R.F. Sanzolone. 1977. Chemical Dissolution of Sulphide Minerals. US Geological Survey Journal of Research. 5: 409-412.
- Hsieh, Y.-P., S.-W. Chung, Y.-J. Tsau and C.-T. Sue. 2002. Analysis of Sulphides in the Presence of Ferric Minerals by Diffusion Methods. Chemical Geology. 182: 195-201.

Kania, T. 1998. Laboratory Methods for Acid-base Accounting: An Update, Chapter 6. In: K.B.C. Brady, M.W. Smith and J. Schueck (eds.) Coal Mine Drainage Prediction and Pollution in Pennsylvania. The Pennsylvania Department of Environmental Protection.

Lapakko, K.A. 2002. Metal Mine Rock and Waste Characterization Tools: An Overview. MMSD No. 67. Posted on the Acid Drainage Technology Initiative – Metal Mining Sector web site.

Li, J., R.St.C. Smart, R.C. Schumann, A.R. Gerson and G. Levay. 2007. A Simplified Method for Estimation of Jarosites and Acid-forming Sulphates in Acid Mine Wastes. *Science of the Total Environment*. 373: 391-403.

Price, W.A. 2005. Case Studies of ML/ARD Assessment and Mitigation: Placement of the Sulphurets Waste Rock in Brucejack Lake. MEND Report 9.1b.

Price, W.A. and D. Yeager. 2004. Case Studies of ML/ARD Assessment and Mitigation at the Johnny Mountain Gold Mine. MEND Report 9.1a.

Rice, C.A., M.L. Tuttle and R.L. Reynolds. 1993. The Analysis of Forms of Sulphur in Ancient Sediments and Sedimentary Rocks: Comments and Cautions. *Chemical Geology*. 107: 83-95.

Sobek, A.A., W.A. Schuller, J.R. Freeman and R.M. Smith. 1978. Field and Laboratory Methods Applicable to Overburdens and Minesoils. Report EPA-600/2-78-054, U.S. National Technical Information Report PB-280 495.

Stanton, R.W. and J.J. Renton. 1981. Organic and Pyritic Sulphur in Coal: Potential Errors in Determinations. West Virginia Geological and Economic Survey, Circular number C-22.

Tuttle, M.L.W., P.H. Briggs and C.J. Berry. 2003. A Method to Separate Phases of Sulfur in Mine-Waste Piles and Natural Alteration Zones and to Use Sulfur Isotopic Compositions to Investigate Release of Metals and Acidity to the Environment. In: Proceedings of the 6th International Conference on Acid Rock Drainage, Cairns, Queensland, Australia, 12 - 18 July.

Tuttle, M.L., M.B. Goldhaber and D.L. Williamson. 1986. An Analytical Scheme for Determining Forms of Sulphur in Oil Shales and Associated Rocks. *Talanta*. 33: 953-61.

Weast, R.C. 1976. CRC Handbook of Chemistry and Physics. CRC Press. USA.

Yin, G. and L.J.J. Catalan. 2003. Use of Alkaline Extraction to Quantify Sulphate Concentration in Oxidized Mine Tailings. *J. Environ. Qual.* 32: 2410-2413.



## 13.0 ACID NEUTRALIZATION POTENTIAL (NP)

### *Some Important Points in this Chapter*

*The term acid neutralization potential (or NP) is presently used for a wide range of different laboratory measurements and field NP predictions. For sulphidic geologic materials, the primary concern is with the neutralization of acid potential from Chapter 12. Acidic drainage pH will result when the exposed acid neutralizing minerals are depleted or the rate of acid neutralization becomes inadequate.*

*To estimate “effective NP” under field conditions from laboratory analyses of NP, several properties and processes are important, including (1) identity, concentration and weathering mechanisms of minerals, (2) their contribution to the measured NP and (3) their cumulative rates of alkalinity production compared to the rate of acid generation under the site specific conditions for each project component. Some carbonate minerals provide a fast neutralization response and thus contribute more to effective NP than ferrous iron and manganese carbonates.*

*There are several methods for measuring NP, including the Carbonate, Sobek (U.S. EPA 600), several Modified, BC Research and Lapakko procedures. Each method has unique strengths and weaknesses, and thus no one method is the best for estimating effective NP. However, the comparison of Carbonate NP with one of the other “bulk-NP” methods assists in estimating the percentage of reactive carbonate contributing to bulk NP.*

### 13.1 Introduction

The broad definition of neutralization is an action that raises an acidic drainage pH or lowers an alkaline drainage pH towards a neutral pH of 7 through reactions in which the hydrogen ion of an acid and the hydroxyl ion of a base combine to form water, the other product being a salt. The primary concern in the prediction of the drainage chemistry from sulphidic geologic materials is with the neutralization of acid (Chapter 12).

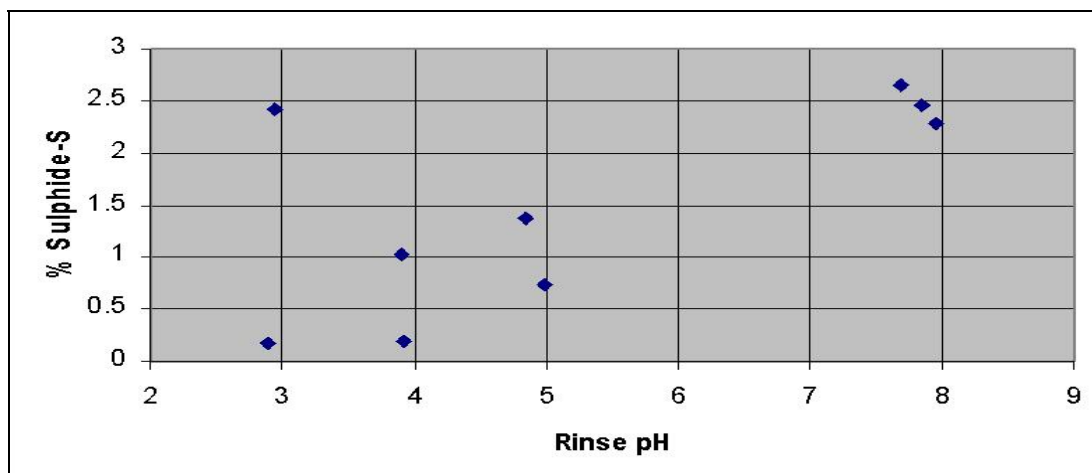
*The term acid neutralization potential (NP) is used for a wide range of different laboratory measurements and field predictions.*

The acid neutralizing potential (or NP) is a measure of the total acid a material is capable of neutralizing, and can be applied to a wide range of laboratory measurements and field predictions. In mine drainage prediction and mitigation, the term acid neutralization potential is often shortened to neutralizing potential or the NP because of the focus on acidic drainage.

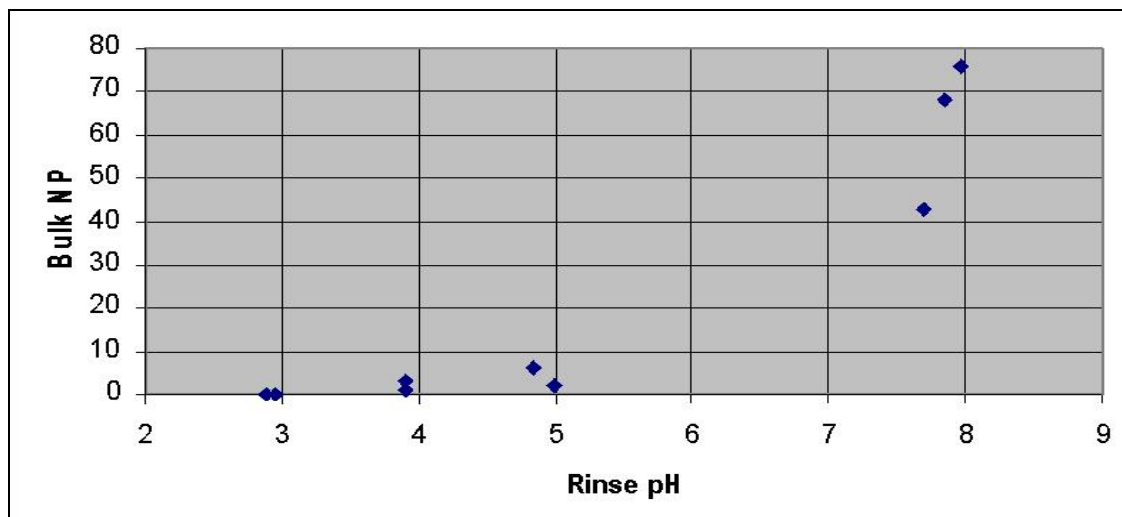
Due to the importance of pH on sulphide oxidation rates and metal solubility, the NP is a major determinant of drainage chemistry. Acid neutralizing reactions may maintain an alkaline or near-neutral pH or minimize the decrease in acidic pH (Table 5.7). A distinction should be made between the total acid a material is capable of neutralizing, and the total acid neutralized before the pH becomes acidic.

The current pH of drainage from weathering rock (e.g. rinse pH) is determined by the balance between current inputs of acid and alkalinity, rather than the concentration of acid generating minerals exposed to oxidizing and leaching conditions (Figure 13.1). The current drainage pH will only become acidic when reactive acid neutralizing minerals are sufficiently depleted such that the rate of acid neutralization is unable to match the rate of acid generation (Figure 13.2). Until they are exhausted, relatively small concentrations of rapidly reacting, acid neutralizing minerals may be capable of neutralizing the acid generated by high concentrations of sulphide minerals.

The future pH of geologic materials that presently produce near-neutral or alkaline pH drainage is determined by whether reactive acid neutralizing minerals will be depleted before the reactive acid generating minerals. This depends on the type and relative magnitude of acid neutralizing (NP) and acid generating (AP) minerals (Figure 13.3).

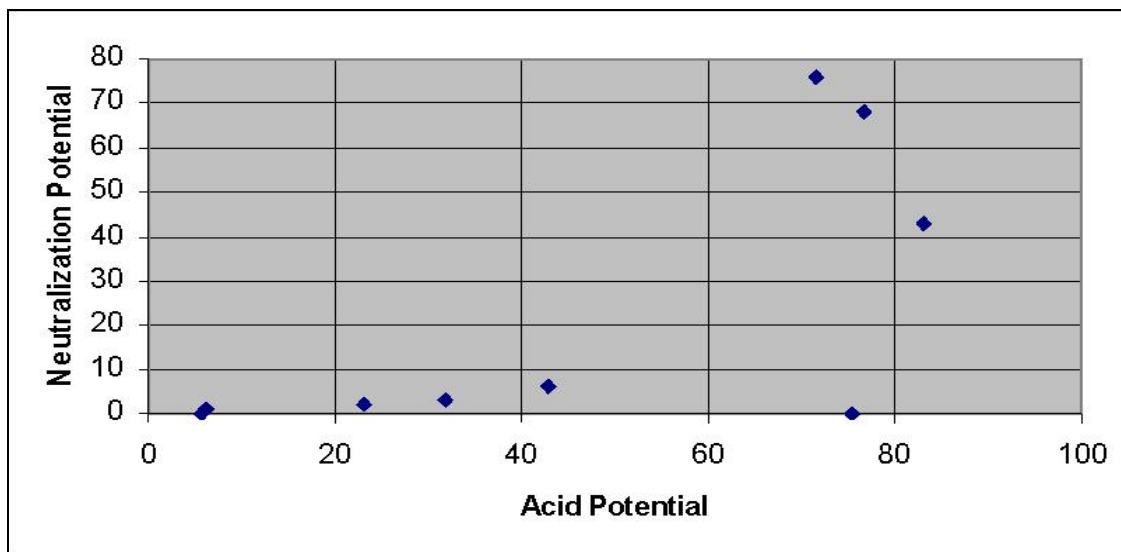


**Figure 13.1** The current drainage pH does not depend solely on the concentration of acid generating minerals.



**Figure 13.2** The current drainage pH only becomes acidic when neutralizing minerals are depleted and the rate of acid neutralization becomes inadequate; NP in units of kg CaCO<sub>3</sub> equivalent / tonne.





**Figure 13.3** The relative magnitude of neutralizing (NP) and acid generating (AP) minerals is used to predict which will be exhausted first; NP and AP in units of kg CaCO<sub>3</sub> equivalent / tonne.

### 13.1.1 Factors Affecting Acid Neutralization Potential

Acid neutralization depends on various site and material specific properties and processes, including:

- acid generation and neutralization by mineral weathering;
- external NP inputs such as lime additions during processing and alkalinity additions in dust and drainage;
- the rate of acid generation; and
- loss of alkalinity in drainage.

Although acid neutralization can come from external sources, the primary sources are usually internal mineral weathering reactions. Analyses and tests for measuring the acid neutralization potential (NP) from mineral weathering, and methods for interpreting their results are important parts of drainage chemistry prediction.

### 13.1.2 Minerals that Contribute to Acid Neutralization

Many common rock forming minerals are capable of acid neutralization, but the reactions and reaction rates vary widely. An understanding of (1) identity, concentration and weathering mechanisms of acid neutralizing minerals, (2) their contribution to the measured NP, and (3) the cumulative rates of acid neutralization compared to the rate of acid generation under the site specific conditions are needed to predict the “effective” NP for each project component (Section 13.1.5) from the results of NP analysis.

An overview of acid neutralization by carbonate minerals, aluminum and iron hydroxides and oxides and silicate and aluminosilicate minerals, the main mineral sources of acid neutralization, is provided below. A more detailed description of acid neutralization by mineral weathering is provided in Chapter 5.

### 13.1.2.1 Carbonate Minerals

Many carbonate minerals are soluble at acidic pH values and provide a fast neutralization response. Only certain carbonate minerals weather fast enough to maintain neutral pH drainage when the rate of sulphide oxidation is high, although other minerals may contribute small, but important, neutralization. The relative rates of neutralization and acid generation are generally not a concern when the NP comes from Ca and Mg carbonate minerals, because their solubility will increase to match an increase in the rate of acid generation.

*Only certain carbonate minerals weather fast enough to maintain neutral pH drainage when the rate of sulphide oxidation is high, although other minerals may contribute small, but important, neutralization.*

The most important carbonate minerals from the perspective of acid neutralization are the Ca, Mg, Fe and Mn carbonate minerals calcite ( $\text{CaCO}_3$ ), dolomite [ $\text{Ca,Mg}(\text{CO}_3)_2$ ], magnesite ( $\text{MgCO}_3$ ), ankerite [ $\text{Ca}(\text{Mg,Fe})(\text{CO}_3)_2$ ], siderite ( $\text{FeCO}_3$ ) and rhodochrosite ( $\text{MnCO}_3$ ). Many Ca, Mg, Fe and Mn carbonate minerals are solid solutions and can have significant compositional variability or deviate from the theoretical formula (e.g. ferrous dolomite and Fe-Mg in ankerite).

Ca and Mg carbonates are net neutralizing under oxidized conditions. Under anaerobic conditions, the dissolution of Fe and Mn carbonates consume acidity in a similar manner to calcite. However under aerobic conditions, the subsequent oxidation and hydrolysis of Fe or Mn produces equivalent acidity to that consumed by  $\text{CO}_3$ , so overall there is no net neutralization from the dissolution of Fe and Mn carbonates.

### 13.1.2.2 Aluminum and Iron Hydroxides and Oxides

Aluminum hydroxides buffer the pH to approximately 4.0-5.0. Iron hydroxides generally buffer pH to between 2.5 and 3.5. While they are unable to maintain a neutral pH, the dissolution of Al and Fe hydroxide and oxide minerals can play an important role in limiting the concentration of acidity and buffering the pH of acidic drainage.

### 13.1.2.3 Silicate Minerals

The speed of acid generation will be an important consideration if NP comes from aluminosilicate minerals. Even the most reactive aluminosilicate minerals will only be capable of neutralizing relatively low rates of acid generation to near-neutral pH. At relatively fast rates of acid generation, reactive aluminosilicate minerals will only be capable of providing a small portion of neutralization and supplementing the acid neutralization by carbonate minerals. At high rates of acid generation, most of the NP in aluminosilicate minerals is not effective NP.

*The speed of acid generation will be an important consideration if NP comes from aluminosilicate minerals.*

More reactive silicate minerals, such as biotite [e.g.  $\text{K}(\text{Mg,Fe})_3(\text{AlSi}_3\text{O}_{10})(\text{OH})_2$ ] may be a significant source of Fe and Al hydroxides.

### 13.1.3 Site and Material Specific Properties and Processes

In addition to the identity, concentration, weathering mechanisms and reactivity of acid neutralizing minerals, the rate of acid neutralization will depend on various site and material specific properties and processes. This includes the properties and processes that determine the:

- physical occlusion or surface exposure of potentially acid neutralizing minerals in coarse fragments or rock walls (e.g. extraction, processing and disposal methods and the resulting particle size);
- mineral reaction rates (e.g. drainage conditions, gas-phase CO<sub>2</sub> content, drainage chemistry, leaching rate and temperature); and
- external inputs and losses (e.g. loss or gain of alkalinity in the drainage).

The rate of alkalinity production from potentially NP contributing minerals can be altered over time by changes in weathering conditions, physical properties and the rate of acid generation. Acid neutralization is a response to acid generation and increases in the rate of acid generation will, in most cases, increase mineral weathering rates.

### 13.1.4 Methods of Analysis

The analytical methods used to measure NP can be divided into two categories:

1. carbonate acid neutralization and
2. bulk acid neutralization.

Carbonate acid neutralization methods calculate the carbonate NP from carbon or carbon dioxide (CO<sub>2</sub>) assays, assuming all carbon or carbon dioxide is CaCO<sub>3</sub> (calcite).

Bulk acid neutralization procedures measure the ability of a pulverised sample to neutralize a known volume and strength of acid over a short exposure period. Bulk acid neutralization procedures using strong acids are the Sobek, the 1989 and 1996 Modified and the BC Research procedures, whereas the Lapakko (pH 6) procedure uses weak acid.

Measurement of both the bulk NP and carbonate NP should be conducted at least initially and the analytical procedures used to derive NP should be clearly identified.

Bulk and carbonate NPs are typically reported as kg of CaCO<sub>3</sub> equivalent/t of sample. Other identical units are tonnes (t) of CaCO<sub>3</sub> equivalent/1000 t of sample and parts per thousand (ppt) CaCO<sub>3</sub> equivalent.

The objective of both the bulk and carbonate NP measurements should be to provide data that

*The objective of both the bulk and carbonate NP measurements should be to provide data that can be used in conjunction with the available mineralogical and kinetic data to predict the magnitude of the effective NP.*

can be used in conjunction with the available mineralogical and kinetic data to predict the magnitude of the effective NP (Section 13.1.5). A standard procedure is necessary so that the test results can be repeated. A standard procedure also allows a comparison to be made with results of other analyses and data from other sites. Mineralogical

and kinetic data can be used to determine the quantity, crystal size and reactivity of the minerals potentially contributing to the measured NP.

### 13.1.5 Differences Between Analytical Results and the Effective NP in the Field

The magnitude of laboratory NP measurements and NP predictions will depend on the measured material, analytical procedures and methods for interpreting the results. Accurate prediction of the acid neutralization that will be effective under field conditions requires an understanding of the analytical procedures, their limitations and differences from field-scale, site and material conditions.

Analyses and tests that measure acid neutralization simplify and accelerate a complex set of properties and processes. Static laboratory NP analyses are unable to match all the site and mine component specific mineralogical, physical and geochemical properties and processes that contribute to the acid neutralization potential under field conditions. Thus, laboratory analyses of the acid neutralizing potential should be viewed as a guide to the magnitude of the effective acid neutralization potential rather than a precise and accurate measurement. The goal of laboratory NP analyses is to provide a value that can be:

- corrected if necessary, based on the results of detailed mineralogical characterization, site specific observation and kinetic test work; and then
- compared with the magnitude and rate of acid generation potential to make predictions of whether drainage will become acidic and how long this will take.

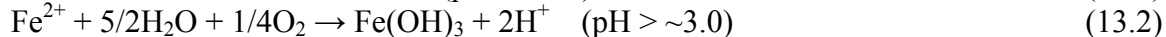
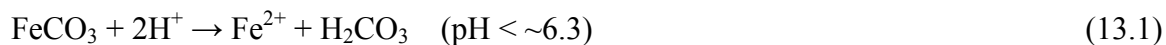
One of the most important concepts to be understood in NP prediction is the “effective neutralization potential” (ENP) (e.g. Morin and Hutt, 1994, 1997, 2008b and 2008c). Effective neutralization potential is the acid neutralization that can neutralize internal and external acidity inputs sufficiently to maintain a near-neutral drainage pH. Alkalinity generated after the onset of acidic conditions is by this definition not effective NP. The effective neutralization potential may differ from the NP measured by a laboratory analysis.

Neutralization potentials measured by analyses and tests may be higher than the effective neutralization potential if they include minerals that are not net neutralizing or are physically unavailable or insufficiently reactive under field-scale site conditions. Conversely, neutralization potential measured by analyses and tests may be lower than the effective acid neutralization potential. This can happen when acid neutralization is too slow to be measured by short term analyses, but is sufficiently fast to maintain a near-neutral drainage pH because of lower in field rates of acid generation.

The primary cause for minerals that are not net neutralizing contributing to measured NP (nnNP) is when the addition of acid produces complete dissolution of Fe and Mn carbonate, but does not result in all or a part of the subsequent acid generation due to oxidation and hydrolysis of the resulting ferrous iron or manganese.

*Analyses and tests that measure acid neutralization simplify and accelerate a complex set of properties and processes.*

*Neutralization potentials measured by analyses and tests may be higher or lower than the effective neutralization potential.*



Unavailable neutralization potential (UNP) is the portion of measured acid neutralization potential that under field-scale site conditions is physically occluded and therefore unable to neutralize acidity and contribute to the maintenance of a near-neutral drainage pH. Physical occlusion may result from:

- surface coatings or cement;
- inclusions within a larger mineral grain; and
- inclusions within a particle or beneath the surface of mine walls.

Insufficiently reactive neutralization potential (IRNP) is the portion of measured neutralization potential that under field-scale site conditions is unable to neutralize acidity sufficiently fast at a near-neutral pH to maintain a near-neutral drainage pH, because the in field weathering rates for these minerals are too slow relative to the rate of acid inputs.

Long-term, slowly reacting neutralization potential (LSNP) is acid neutralization that is kinetically limited and whose alkalinity production is too slow to be measured by short term analyses of the neutralization potential, but is able to neutralize acidity sufficiently fast to maintain a near-neutral drainage pH because of lower in field rates of acid generation (Morin and Hutt, 2008a).

Based on the preceding categories of NP, effective neutralization potential (ENP) can be defined mathematically by:

$$\text{ENP} = \text{Measured} - \text{NP} - (\text{nnNP} + \text{UNP} + \text{IRNP}) + \text{LSNP}$$

The rate at which mineral weathering neutralizes acidity and the magnitude of the effective, unavailable, insufficiently reactive and long-term, slowly reacting neutralization potentials will depend on various site and material specific properties and processes. For example, a material may have higher ENP values as a result of the reduction in the rate of acid generation caused by restrictions in the oxygen supply.

Analytical methods do not exist for the direct measurement of the unavailable, insufficiently reactive and long-term, slowly reacting neutralization potentials. The present best practice for prediction of effective NP is to interpret the laboratory NP measurements in combination with knowledge regarding the:

- potentially contributing minerals, their reactivity and relative exposure under the site specific conditions; and
- rates of acid generation under site specific conditions.

The effective NP can be measured empirically from the acid neutralization potential that is consumed prior to the onset of acid pH drainage (pH < 6). For example, the effective NP prior to

the onset of acid pH drainage in a humidity cell or column can be calculated from the cumulative calcium plus magnesium or sulphate released in drainage and precipitated in secondary minerals.

Differences in conditions between tests used to predict the effective NP and field conditions should be considered in the data interpretation and the sources of data on the effective neutralization potential should all be indicated.

## 13.2 Carbonate Neutralization Potential

The carbonate neutralization potential ( $\text{CO}_3\text{-NP}$ ) is the acid neutralization capacity if all the carbonate in a sample reacted like calcite, the most common and fastest neutralizing carbonate mineral. The carbonate concentration is calculated from assays of total carbon, inorganic carbon or carbon dioxide.  $\text{CO}_3\text{-NP}$  is

*The carbonate neutralization potential ( $\text{CO}_3\text{-NP}$ ) is the acid neutralization capacity if all the carbonate in a sample reacted like calcite, the most common and fastest neutralizing carbonate mineral.*

typically reported as kg of  $\text{CaCO}_3$  equivalent/t of sample. The percentage of carbon is multiplied by 83.4 to obtain the kg  $\text{CaCO}_3$ /tonne.  $\text{CO}_3\text{-NP}$  is a potentially useful measure because carbonate minerals are often the only rapidly available NP source capable of matching the fastest rates of acid generation.

Various procedures are used to measure inorganic carbon. Where all the carbon in a sample is carbonate, the easiest procedure is to use total carbon to calculate the  $\text{CO}_3\text{-NP}$ . The simplest analytical procedure for measuring total carbon is the same Leco equipment used for the analysis of total sulphur (Chapter 12).

Where materials contain significant sources of non-carbonate carbon, such as organic matter or graphite, the more time consuming acid soluble analysis of carbonate-carbon must be used to calculate  $\text{CO}_3\text{-NP}$ . Carbonate-carbon is analyzed by the conversion of carbonate minerals to carbon dioxide when acidified with hydrochloric acid. Materials commonly containing significant sources of non-carbonate carbon include coal, mudstone and other organic sedimentary rock types and geological materials within the rooting zone.

### 13.2.1 Methods

1. If the only significant source of carbon is carbonate carbon,  $\text{CO}_3\text{-NP}$  can be calculated from the total carbon value measured with Leco equipment (~\$ 12/sample).
2. If there are significant sources of non-carbonate carbon,  $\text{CO}_3\text{-NP}$  can be calculated from carbonate-carbon analyzed by the conversion of carbonate minerals to carbon dioxide when acidified with hydrochloric acid (~\$ 20/sample). This determination can be made in one of several ways.
  - a) First, measure the total carbon concentration with the Leco equipment. Second, react a sub-sample with HCl to remove all inorganic carbonate-C and measure the remaining organic-C concentration with the Leco equipment. Inorganic carbonate-C is determined by

measuring the difference between total C and organic C (should be confirmed by mineralogical examinations).

b) Acidification of a 0.01-0.03 g pulverized sample in a heated and sealed reaction chamber. Carbon dioxide free air is used to move the evolved carbon dioxide into the carbon dioxide coulometer. Carbon dioxide in the coulometer is absorbed and reacts with methanolamine to form a titratable acid, which changes the colour of the solution. The concentration of carbon dioxide is calculated from a photodetector measurement of the percent transmittance.

c) Loss of weight after a sample is acidified.

- Calculation of CO<sub>3</sub>-NP (kg CaCO<sub>3</sub> equivalent / tonne) is as follows:

a) Calculation if carbon is reported as % C:

$$\text{CO}_3\text{-NP (kg CaCO}_3 \text{ eq / tonne)} = (\% \text{ C}) \times (100.09/12.01) \times (10)$$

b) Calculation if carbon is reported as % CO<sub>2</sub>:

$$\text{CO}_3\text{-NP (kg CaCO}_3 \text{ eq / tonne)} = (\% \text{ CO}_2) \times (100.09/44.01) \times (10)$$

### 13.2.2 Discussion

Minimum time required is less than half an hour to calculate CO<sub>3</sub>-NP from total-C. Measurement of CO<sub>3</sub>-NP from the difference between total-C and organic-C takes about 18 hours as the residue needs to be dried overnight. Over estimation of the CO<sub>3</sub>-NP may occur from:

- use of total carbon to calculate the CO<sub>3</sub>-NP when materials contain significant sources of non-carbonate carbon, such as organic matter or graphite; or
- a failure to detect the presence of significant Fe and Mn carbonates.

Acid soluble analysis of carbonate-carbon should be used to calculate the carbonate acid neutralization potential (CO<sub>3</sub>-NP) when materials contain significant sources of non-carbonate carbon.

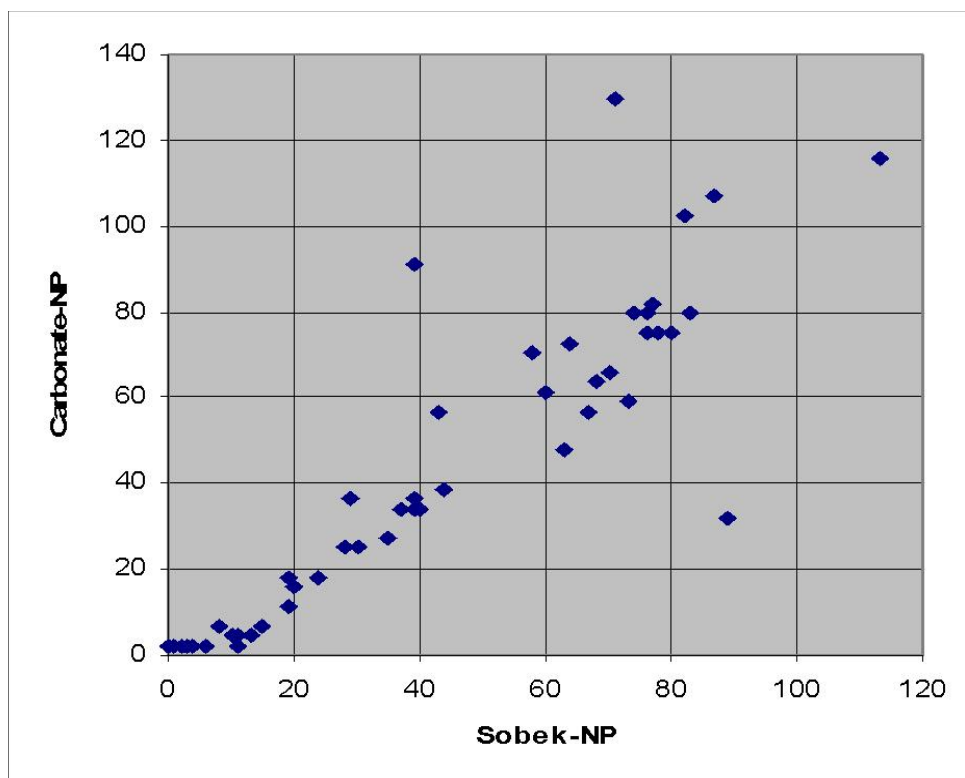
The dissolution of ferrous iron or manganese carbonate initially consumes acidity in a similar manner to calcite (Section 13.1.5).

*Under aerobic conditions and a pH > 3.5, the subsequent oxidation and hydrolysis of Fe or Mn produces equivalent acidity to that consumed, so overall there is no neutralization.*

However under aerobic conditions and a pH > 3.5, the subsequent oxidation and hydrolysis of Fe or Mn produces equivalent acidity to that consumed, so

overall there is no neutralization. The occurrence of significant concentrations Fe and Mn carbonate containing minerals can result in the CO<sub>3</sub>-NP significantly over estimating the carbonate neutralizing capacity under aerobic conditions. Their presence can be detected by:

- plotting CO<sub>3</sub>-NP versus acid titratable bulk NP (Figure 13.4 and Section 13.3); and
- XRD or sub-microscopic mineralogical analysis (Chapter 17).



**Figure 13.4** The presence of significant concentrations of Fe and Mn  $\text{CO}_3$  can be detected by  $\text{CO}_3\text{-NP} > \text{acid titratable bulk NP}$ , the reverse of what is usually observed.

### 13.3 Bulk Neutralization Potential Analyses

#### 13.3.1 Introduction

Bulk neutralization potential analyses are wet chemical, static laboratory analyses that measure the ability of a pulverized sample to neutralize a known volume and strength of acid. The objective of bulk NP procedures is to measure the neutralization present in fast neutralizing carbonate minerals, particularly calcite and dolomite, and the most reactive silicate minerals. Bulk neutralization potential analyses vary in:

*Bulk neutralization potential analyses are wet chemical, static laboratory analyses that measure the ability of a pulverized sample to neutralize a known volume and strength of acid.*

- overall time required;
- the need to redo the analysis if the pH is outside the required range;
- particle size and weight of sample;
- type, strength and volume of acid;
- procedure for determining the strength and volume of acid;
- time of exposure to acid;
- the extent of heating;
- the value to which the pH is lowered; and
- whether the acid is back titrated.



Examples of bulk neutralization potential analyses are the Sobek, Modified Lawrence, BC Research and Lapakko tests. The procedures in most common use and recommended here are the Sobek and Modified Lawrence tests.

Laboratories and those requesting these tests often make errors in the analysis and the interpretation of results. Practitioners should check to ensure analytical procedures such as the acid addition and that the repeats of the Modified tests that fall outside the required acid pH range were performed correctly.

### 13.3.2 Sobek NP Procedure

The objective of the Sobek NP method is to add sufficient acid to dissolve all the carbonate plus the highly reactive silicate NP. The Sobek NP or U.S. EPA-600 method (Sobek et al., 1978) was modified from the method developed by Smith et al. (1974).

The sample is ground to < 0.24 mm or 60-mesh. The amount of hydrochloric acid added is determined by the fizz resulting from adding drops of hydrochloric acid to 0.5 g of sample. The strength of the effervescence roughly corresponds to the amount of reactive carbonate present:

- no fizz - 20 mL 0.1 N;
- slight fizz - 40 mL 0.1 N;
- moderate fizz - 40 mL 0.5 N; and
- strong fizz - 80 mL 0.5 N.

The selected volume and concentration of hydrochloric acid is added to a 2 g sample. The mixture of acid and sample is then heated to near boiling until cessation of bubble production occurs, indicating that the reaction has ceased. The mixture is then cooled and titrated to pH 7.0 with sodium hydroxide (NaOH) to measure the amount of acid consumed by the sample.

The Sobek NP method is as follows.

#### Chemicals:

1. Carbon dioxide free water: Heat distilled water just to boiling in the beaker. Allow it to cool slightly and pour it into a container equipped with an ascarite tube. Cool it to room temperature before use.
2. Hydrochloric acid (HCl) solution, 0.1 N, certified grade.
3. Sodium hydroxide (NaOH), approximately 0.5 N: Dissolve 20.0 g of NaOH pellets in carbon dioxide free water and dilute it to 1 liter. Protect it from CO<sub>2</sub> in the air with an ascarite tube. Standardize the solution by placing 50 mL of certified 0.1 N HCl in a beaker and titrating with the prepared 0.5 N NaOH until a pH of 7.00 is obtained. Calculate the normality of the NaOH using the following equation:

$$N_2 = (N_1 \times V_1) / V_2$$

where: V<sub>1</sub> = Volume of HCl used.

N<sub>1</sub> = Normality of HCl used.

V<sub>2</sub> = Volume of NaOH used.

N<sub>2</sub> = Calculated normality of NaOH.

4. Sodium hydroxide (NaOH) approximately 0.1 N: Dilute 200 mL of 0.5 N NaOH with carbon dioxide free water to a volume of 1 liter. Protect it from CO<sub>2</sub> in air with an ascarite tube. Standardize the solution by placing 20 mL of certified 0.1 N HCl in a beaker and titrating it with the prepared 0.1 N NaOH until a pH of 7.00 is obtained. Calculate the normality of the NaOH using the equation in No. 3 above.
5. Hydrochloric acid (HCl), approximately 0.5 N: Dilute 42 mL of concentrated HCl to a volume of 1 liter with distilled water. Standardize solution by placing 20 mL of the known normality NaOH prepared in No. 3 above in a beaker and titrating with the prepared HCl until a pH of 7.00 is obtained. Calculate the normality of the HCl using the following equation:

$$N_1 = (N_2 \times V_2)/V_1$$

where: V<sub>2</sub> = Volume of NaOH used.  
N<sub>2</sub> = Normality of NaOH used.  
V<sub>1</sub> = Volume of HCl used.  
N<sub>1</sub> = Calculated Normality of HCl.

6. Hydrochloric acid (HCl), approximately 0.1 N: Dilute 200 mL of 0.5 N HCl to a volume of 1 liter with distilled water. Standardize solution as in step 5 above, but use 20 mL of the known normality NaOH prepared in No. 4 above.
7. Hydrochloric acid (HCl), 1 part acid to 3 parts water: Dilute 250 mL of concentrated HCl with 750 mL of distilled water.

Note: Other methods of standardizing prepared NaOH solutions, such as the use of triplicate, accurately weighed samples of potassium acid phthalate, can be employed and should be consistent with a laboratory's QA/QC procedures.

#### Materials:

1. Flasks, Erlenmeyer, 250 mL.
2. Buret, 100 mL (one required for each acid and one for each base).
3. Hot plate, steam bath can be substituted.
4. pH meter equipped with combination electrode.
5. Balance, can be read to 0.01 g.

#### Carbonate-NP

The carbonate-NP should be determined first to ensure the correct fizz rating and the resulting acid addition (Section 13.2).

#### Fizz Test:

1. Place approximately 0.5 g of sample (less than 60 mesh) on a piece of aluminum foil or a watch glass.
2. Add one or two drops of 1:3 (25%) HCl to the sample. The presence of CaCO<sub>3</sub> is indicated by a bubbling or an audible "fizz".
3. Observe the degree of reaction and assign a fizz rating as "none, slight, moderate, or strong fizz". One description of the four levels of fizz ratings is as follows (personal communication with Ivy Rajan, Cantest Ltd.):

None = no reaction

Slight = visible bubbles, do not break quickly

Moderate = visible bubbles, break quickly, audible

Strong = explosion-like on impact

4. [Author's Addition] Compare the equivalent kg  $\text{CaCO}_3$  / tonne of the selected fizz rating (Table 13.1) with the  $\text{CO}_3$ -NP (Table 13.2). Rerun the fizz rating if the equivalent kg  $\text{CaCO}_3$  / tonne of the fizz rating is a category higher than the measured  $\text{CO}_3$ -NP.
5. Report the fizz rating along with results of the NP procedure.

NP Procedure:

1. Weigh 2.00 g of sample (less than 60 mesh) into a 250 mL Erlenmeyer flask.
2. At the beginning of the test, carefully add HCl, as indicated in Table 13.1, into the flask containing the sample.

**Table 13.1 The acid addition and equivalent kg  $\text{CaCO}_3$  / tonne of the acid for the different Sobek NP procedure fizz ratings.**

Fizz Rating	mL of HCL	Normality of HCl	Equivalent kg $\text{CaCO}_3$ /tonne
None	20	0.1	50
Slight	40	0.1	100
Moderate	40	0.5	500
Strong	80	0.5	1000

3. Heat nearly to boiling, swirling flask every 5 minutes, until reaction is complete. Note: Reaction is complete when no gas evolution is visible and particles settle evenly over the bottom of the flask.
4. Add distilled water to make a total volume of 125 mL.
5. Boil contents of the flask for one minute and cool to slightly above room temperature. Cover tightly and cool to room temperature. Caution: Do not place a rubber stopper in the hot flask as it may implode upon cooling.
6. Titrate using 0.1 N NaOH or 0.5 N NaOH (concentration exactly known) to pH 7.0 using a pH meter and buret. The concentration of NaOH used in the titration should correspond to the concentration of the HCl used in No. 5 above. Note: Titrate with NaOH until a constant reading of pH 7.0 remains for at least 30 seconds.
7. If less than 3 mL of the NaOH is required to obtain a pH of 7.0, it is likely that the HCl added was not sufficient to neutralize all the base present in the 2.00 g sample. A duplicate sample should be run using the next higher volume or concentration of acid as indicated in Table 13.1.
8. [Author's Addition] Compare the equivalent kg  $\text{CaCO}_3$  / tonne of the acid added (fizz rating in Table 13.1) with the resulting kg  $\text{CaCO}_3$  / tonne of the  $\text{CO}_3$ -NP and Sobek-NP (Table 13.2). Sobek-NP tests should be rerun or checked if the equivalent kg  $\text{CaCO}_3$  / tonne of the fizz rating is a category higher than the measured  $\text{CO}_3$ -NP or Sobek NP.
9. Run a blank for the volume and normality of acid corresponding to the fizz ratings.

**Table 13.2 Examples of Sobek-NP discrepancies, ranging from none to significant, when two different acid additions are based on the appropriate (slight) and over estimated (strong) fizz ratings (from Frostad et al., 2003).**

Sample	CO <sub>3</sub> -NP	Slight Fizz (100 kg CaCO <sub>3</sub> / t)		Strong Fizz (1000 kg CaCO <sub>3</sub> / t)	
		Sobek NP	Sobek NP minus CO <sub>3</sub> -NP	Sobek NP	Sobek NP minus CO <sub>3</sub> -NP
1	83	86	3	101	18
2	42	51	9	88	44
3	41	61	20	82	41
4	14	28	14	28	14

### Calculations

1. Constant (C) = (mL acid in blank) / (mL base in blank).
2. mL acid consumed = (mL acid added) - (mL base added x C).
3. Neutralization Potential (as kg CaCO<sub>3</sub> equivalent/1000 tonne material) = (mL of acid consumed) x (25.0) x (N of acid).

### Discussion

The minimum time required for Sobek-NP including heating and cooling is 3 to 4 hours.

The most common mistake made in Sobek-NP analyses is the incorrect addition of acid. This mistake results from not conducting or improperly interpreting the results of the fizz test (Figure 13.5). Incorrect interpretations of the fizz test in the Sobek and Modified NP procedures may result from the subjective nature of the fizz test. Mistakes have also occurred when laboratories have raised the fizz rating to increase the NP measurement, erroneously thinking they will improve NP measurement or skipped the fizz test and used the high fizz rating to save time and cut costs.

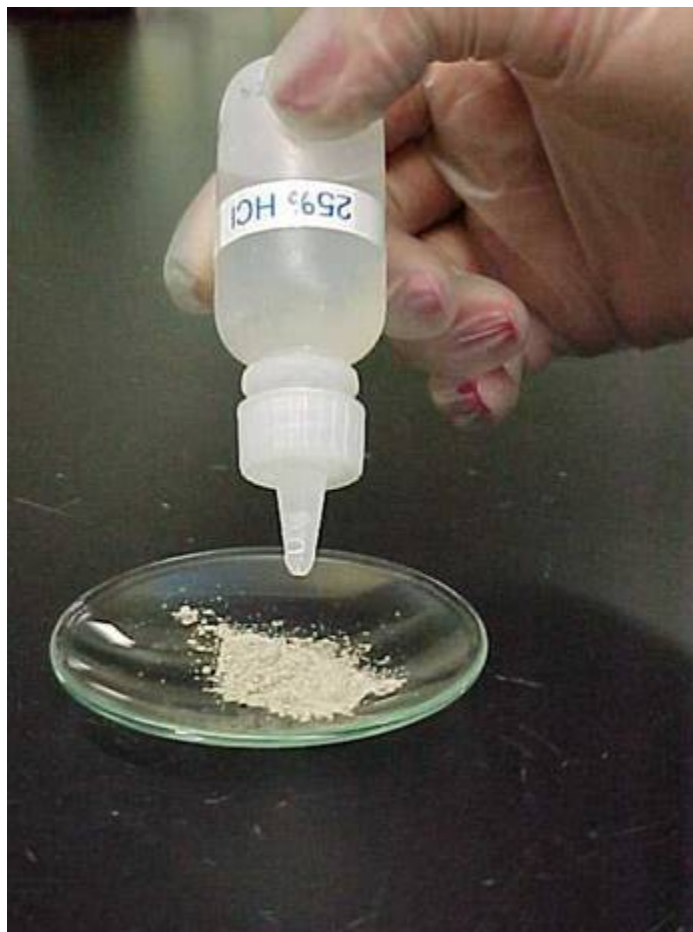
*The most common mistake made in Sobek-NP analyses is the incorrect addition of acid.*

Testing has shown that the main concern is the incorrect use of the moderate (500 kg CaCO<sub>3</sub> eq/t) and strong (1000 kg CaCO<sub>3</sub> eq/t) fizz rating, because this involves a large increase in acid compared to the slight rating (100 kg CaCO<sub>3</sub> eq/t). The addition of too much acid can dissolve high concentrations of some aluminosilicate minerals that are not soluble at neutral pH. Table 13.2 illustrates the variable impact, ranging from none to significant, of adding too much acid.

Step 8 has been added to the procedure to ensure practitioners use the correct fizz rating and acid addition. Notably, the time required to conduct the Sobek-NP procedure, compare CO<sub>3</sub>-NP and Sobek NP vs. Sobek fizz rating and repeat the test is less than the time required to run a Modified NP procedure.

Important considerations resulting from the above include:

- report the fizz rating and acid addition along with Sobek-NP results; and
- possibly substituting CO<sub>3</sub>-NP for the fizz rating when selecting the appropriate acid addition.



**Figure 13.5** The fizz test consists of adding one or two drops of 25% HCl to a 0.5 g sample and observing the degree of reaction.

### 13.3.3 1996 Modified NP Procedure

Like the Sobek method, the objective of the 1989, 1996, and other Modified NP methods are to add sufficient acid to dissolve all the carbonate plus highly reactive silicate NP. The 1996 Modified NP method was developed by Lawrence and Wang (1996) for a MEND report and is a revised version of a 1989 modification of the Sobek procedure developed by Coastech Research Inc. (1989). Because of the sometimes small but significant differences among these modified methods, it is important to identify and understand the particular modification used by a laboratory.

*Like the Sobek method, the objective of the 1989, 1996, and other Modified NP methods is to add sufficient acid to dissolve all the carbonate plus highly reactive silicate NP.*

#### Method:

The carbonate-NP should be determined first to ensure the correct fizz rating and the resulting acid addition (Section 13.2).

The 1996 Modified NP method is as follows:

1. Pulverize the sample to 80% minus 200 mesh.
2. Add 3-4 drops of 25% HCl to 2 to 3 g of sample on a watch glass or piece of aluminum foil. Observe the degree of reaction and assign a fizz rating as “none, slight, moderate, or strong fizz” (See Section 13.3.2).
3. *[Author's Addition] Compare the equivalent kg CaCO<sub>3</sub> / tonne of the selected fizz rating Table 13.1) with the CO<sub>3</sub>-NP (Table 13.2). Rerun the fizz rating if the equivalent kg CaCO<sub>3</sub> / tonne of the fizz rating is a category higher than the measured CO<sub>3</sub>-NP.*
4. Weigh approximately 2.00 g of sample into a 250 mL conical flask and add approximately 90 mL of distilled water.
5. At the beginning of the test (time = 0), add a volume of certified or standardized 1.0 N HCl according to the fizz rating as follows:

Fizz Rating	Volume of 1.0 N HCl (mL)		Equivalent kg CaCO <sub>3</sub> / tonne	
	at time = 0 h	at time = 2 h	at time = 0 h	at time = 2 h
None	1	1	25	25
Slight	2	1	50	25
Moderate	2	2	50	50
Strong	3	2	75	50

6. Place the flask on a shaking apparatus such as a reciprocating shaker, maintained at room temperature. After approximately 2 hours, add the second acid quantity as indicated in the above table.
7. After approximately 22 hours, check the pH of the pulp. If it is > 2.5, add a measured volume of 1.0 N HCl to bring the pH into the range 2.0 to 2.5. If the pH is < 2.0, too much acid was added in steps 2 and 3. In this case, repeat the test adding a reduced volume of HCl.
8. After 24 hours, terminate the test and add distilled water to the flask to bring the volume to approximately 125 mL. Measure and record the pH, making sure it is in the required range of 2.0 to 2.5.
9. Titrate the contents of the flask to a pH of 8.3 using certified or standardized 0.5 N or 0.1 N NaOH.
10. Calculate the NP of the sample as follows:

$$\text{Modified NP (kg CaCO}_3\text{/t)} = \frac{[\text{N} \times \text{vol (mL) HCl}] - [\text{N} \times \text{vol (mL) NaOH}] \times 50}{\text{weight of sample (g)}}$$

11. *[Author's Addition] Compare the equivalent kg CaCO<sub>3</sub> / tonne of the acid added (fizz rating in Table 13.1) with the resulting kg CaCO<sub>3</sub> / tonne of the CO<sub>3</sub>-NP and Modified-NP (Table 13.2). Modified-NP tests should be rerun or checked if the equivalent kg CaCO<sub>3</sub> / tonne of the fizz rating is a category higher than the measured CO<sub>3</sub>-NP or Modified-NP.*

### 13.3.4 Comparison of Sobek and Modified Procedures

Both the Sobek NP (Section 13.2) and the 1996 Modified NP procedures use:

- a 2 g sample;

- hydrochloric acid;
- a fizz test to determine the magnitude of the acid addition; and
- back titration with NaOH.

Features of the Modified NP method that differ from the Sobek NP method include:

- The sample is 80% minus 200 mesh ( $< 74 \mu\text{m}$ ) rather than minus 60 mesh ( $< 250 \mu\text{m}$ ). In practice, laboratories may use the same crushing and grinding and therefore a similar particle size for both methods.
- 90 mL of distilled water is added to the sample diluting the strength of the acid.
- The digestion is for 24 hours, at ambient temperature and agitated, instead of a few hours and heated ( $\sim 85^\circ\text{C}$ ) acid digestion.
- Acid is added initially and after 2 hours, and after 22 hours if the pH is  $> 2.5$ , not just at the start.
- The mixture of acid and sample is required to have a pH range of 2.0 to 2.5 at the completion of the 24 hour digestion. If not, the test should be re-run with an adjusted acid addition based on the previous test's final pH. There is no required pH range for the mixture of acid and sample in the Sobek method and although the acid digestion is for a far shorter period of time, the acid is heated to near boiling for some of that time.
- The NaOH titration endpoint is pH 8.3 rather than pH 7.0. pH 8.3 is the endpoint used to measure alkalinity, but may not apply to all near-neutral conditions.
- The amounts of hydrochloric acid added initially, plus that added after 2 hours, for the none, slight, moderate, and strong fizz ratings are equivalent to maximum NP's of 50, 75, 100 and 125 kg  $\text{CaCO}_3$  eq/ tonne compared to 50, 100, 500 and 1000 kg  $\text{CaCO}_3$  eq/ tonne in the Sobek method. The Modified test has more options for acid addition for low to moderate NP values but high NP values might not be properly characterized by the end of the Modified test.

Advantages of the Sobek NP procedure include the:

- speed of the analysis; and
- decades of worldwide experience in its use to estimate the effective NP.

The speed of analysis of 3 to 4 hours is a major advantage of the Sobek NP for operational material characterization where projects need operational confirmation or will segregate geological materials based on their potential to generate acidic drainage. Twenty-five hours or 50 hours for reruns of the Modified NP analysis may be impractical for operational material characterization. The extra cost and time of repeating the 1996 Modified NP method has caused some practitioners to use the older 1989 Modified NP method or skip the reruns required with 1996 Modified method so their Modified NP analyses have been closer to the 1989 method.

Another advantage of the Sobek procedure is that there is the already extensive experience in correcting the results for contributions of iron and manganese carbonates and insufficiently reactive aluminosilicate minerals (Morin and Hutt, 2008a).

Advantages of the Modified bulk-NP procedure include the:

- greater number of different acid additions around the NP values commonly found in sulphidic geologic materials;
- higher titration end point;
- measurement of the digestion pH as a check on the acid addition; and
- more consistent pH of the digestion.

A potential weakness of both the Sobek and Modified NP procedures is the subjective nature of the fizz test. Fizz test mistakes can be avoided in the Modified procedure so long as the test is repeated if the pH is incorrect. Comparison of the CO<sub>3</sub>-NP and the fizz based acid addition will ensure the acid addition is appropriate in the Sobek procedure. Notably, the time required to compare the CO<sub>3</sub>-NP vs. fizz rating and to repeat the Sobek bulk-NP procedure is less than that of a 24 hour Modified NP.

The speed of the Sobek and Modified NP analyses is the result of the rapid dissolution of acid neutralizing minerals by the strong acid. However in both procedures, the strong acid needed to obtain results in a timely manner may dissolve minerals that do not contribute similar acid neutralization in the field. The sample is exposed to strong acid for up to 25 hours in the Modified method. In the Sobek NP procedure, the sample may be exposed to strong acid for up to 3 to 4 hours, but the resulting pH may be lower and the acid is heated to near boiling for part of that time.

The potential disadvantage of correcting the 0 and 2 hour acid additions within two hours of the end of the test in the Modified NP is that previous weakly acidic conditions may have resulted in NP minerals being coated with secondary minerals, so they are no longer reactive.

### 13.3.5 Other Bulk NP Methods

In the BC Research and Lapakko tests, the NP is determined by the amount of acid required to

*In the BC Research and Lapakko tests, the NP is determined by the amount of acid required to reach the specified pH values of 3.5 and 6.0.*

reach the specified pH values of 3.5 and 6.0. Sulphuric acid is added incrementally by automatic titration until the specified pH values are reached and acid consumption is less than 0.1 mL in 4 hours. Thus, the primary advantage of these methods over

the Sobek and Modified methods (Sections 13.3.2 and 13.3.3) is that initial fizz ratings and corresponding guesses of maximum NP are not required. This can reduce the need for re-testing.

Disadvantages of these tests include the following:

- both tests can take 24 hours or more to complete;
- the BC Research test can result in a large over estimation of NP where iron and manganese carbonates are significant because acid addition results in dissolution of these carbonates but the lack of back titration results in incomplete oxidation and hydrolysis of ferrous iron and manganese; and
- the Lapakko procedure has a relatively high titration endpoint (pH 6), so it can underestimate the effective NP if there are sources other than calcite and dolomite.



### 13.3.6 Data Interpretation

Results of bulk NP analysis (Sections 13.2 to 13.5) are not the same as effective NP results (Section 13.1.5). Results of the bulk NP analyses provide a basis for estimating the effective NP but additional information is required. The effective NP, like the field application of other static test measures, depends on mineral abundance and reaction rates. Therefore, the prediction of effective NP must include consideration of the mineralogy and the weathering conditions in the field versus those of the corresponding laboratory measurements. Note that the same is true for sulphur species and acid potential (Chapter 12).

*Results of bulk-NP analysis are not the same as effective NP; additional information is required.*

Possible discrepancies between the laboratory measurements of NP and effective NP that should be considered in the interpretation of test data may result from bulk NP measurement:

- on a pulverized sample;
- with strong acid; and
- for a limited duration.

Pulverizing the sample increases mineral surface exposure and lessens unavailable NP (Section 13.1.5). Strong acid results in more intense weathering conditions than neutral pH weathering, which potentially increases the contribution of insufficiently reactive and not net neutralizing NP to the measured NP. The limited duration may result in an under estimation of slowly reacting minerals (long term, slowly reacting neutralization potential).

An important part of the interpretation of the bulk NP results is the determination of whether corrections are needed in the prediction of effective NP to remove the contributions of:

- insufficiently reactive aluminosilicate minerals; and
- iron and manganese carbonates.

Although they are usually insufficiently reactive to contribute to the effective NP, if the rate of acid generation is very low, an addition to the measured NP may be required to account for slowly reactive aluminosilicate minerals that are capable of neutralization at a neutral pH but are underestimated because of the short term nature of bulk NP procedures (Section 13.1.5).

#### 13.3.6.1 Aluminosilicate NP

Where there is no significant contribution of iron and manganese carbonates to the  $\text{CO}_3\text{-NP}$ , a comparison of the  $\text{CO}_3\text{-NP}$  and bulk NP can be used to roughly assess the relative amounts of  $\text{CO}_3\text{-NP}$  and aluminosilicate NP within the bulk NP (Morin and Hutt, 2008a). Rietveld analysis of XRD data or some other quantitative mineralogical procedure should be used to verify the presence of minerals that are potentially effective NP sources under field conditions (Chapter 17). Also, base cation release in humidity cell testing will indicate potential sources, as well as the reactivity of aluminosilicate alkalinity (Chapter 18).

Studies that included mineralogical evidence in addition to measures of bulk NP (Lapakko, 1993, Jambor, 2003; Jambor et al., 2000, 2002 and 2005) indicated that, if the analyses are conducted

*Studies showed that, if the analyses are conducted correctly, the Modified and Sobek NP procedures dissolve similar, relatively low concentrations of aluminosilicate NP.*

correctly, the Modified and Sobek NP procedures both dissolve relatively low concentrations of aluminosilicate NP. Lapakko (1993) found NP results for the 1989 Modified and Sobek NP were similar. Sobek

values were slightly higher in several instances, but sometimes the reverse was true. Site specific factors that are not yet well defined can certainly affect the ranking of NP values by different bulk NP methods.

Sobek NP results reported in Jambor (2003) and Jambor et al. (2000 and 2002) were  $< 10 \text{ kg CaCO}_3 / \text{t}$  and for the most part  $< 5 \text{ kg CaCO}_3 / \text{t}$  for a wide range of aluminosilicate minerals. Exceptions included anorthite, olivine and some chlorite and clay minerals. In a wide range of mined rock types containing negligible carbonate but a large proportion of plagioclase and phyllosilicate minerals, Sobek NP values were all less than  $20 \text{ kg/t}$  (Price and Kwong, 1997). Much higher values of aluminosilicate NP result either from the presence of minerals that are soluble at low pH (e.g. Mg silicates in kimberlite) or from the addition of acid far in excess of the  $\text{CO}_3\text{-NP}$ .

Studies have shown that decreasing the particle size may increase the bulk NP, raising concerns about the impact on bulk NP of differences in the mesh size and the grinding procedure (White et al., 1998; Jambor and Dutrizac, 2002). The increase in NP due to a decreasing particle size is attributed to damage to the crystal structure and an increase in the surface area exposed to the acid (Jambor, 2003). This suggests that practitioners should maintain a consistent mesh size and avoid over grinding. Jambor and Dutrizac (2002) concluded that the difference in Sobek NP between minus 200 mesh ( $< 74 \mu\text{m}$ ) and minus 60 mesh ( $< 250 \mu\text{m}$ ) was less than  $5 \text{ kg CaCO}_3 / \text{t}$  and therefore only important for samples with a low NP and AP. Jambor and Dutrizac (2002) also concluded that normalizing Sobek NP to the BET determined unit surface area can give misleading results.

All bulk NP procedures may underestimate effective NP where the rate of acid generation is sufficiently low and aluminosilicate minerals are sufficiently reactive to provide long term neutralization (Morin and Hutt, 1994 and 1997). In this situation, kinetic tests and mineralogical data can be used to predict the future drainage pH.

### 13.3.6.2 Fe-Mn Carbonate Minerals

While the influence is smaller than that on  $\text{CO}_3\text{-NP}$ , there is also a potential for iron and manganese carbonate minerals to contribute to the Sobek and Modified bulk-NP. This potential arises from the relatively fast rate of carbonate dissolution in the neutralizing part of the reaction at low pH (Reaction 13.1), compared to the sometimes slower rate of the acid generating metal oxidation and hydrolysis during the back titration (Reaction 13.2). There is therefore a potential that the back titration will conclude before all the acidity from the slower oxidation and hydrolysis has been produced (Lapakko, 1993). The likelihood of incomplete oxidation and hydrolysis is higher for  $\text{MnCO}_3$  than  $\text{FeCO}_3$  because, due to kinetic and thermodynamic constraints, these reactions are generally slower for Mn than Fe.

Potential ways of increasing the acid generating metal oxidation and hydrolysis reactions and thus minimizing the contribution of iron and manganese carbonate to the bulk-NP include using a modification to the standard Sobek method where peroxide is added to ensure complete oxidation and hydrolysis of Fe and Mn CO<sub>3</sub> (Meek, 1981; Skousen et al., 1997; White et al., 1998). The Skoussen NP is a modification of the Sobek NP procedure which filters the sample after acid is added and then adds hydrogen peroxide and boils the filtrate to promote oxidation of Fe and Mn before titrating with NaOH to pH 7.0.

The degree to which ferrous iron or manganese carbonates may contribute to the measured NP is a function of the time of exposure to neutral pH and the pH of the titration end point (Lapakko, personal communication). The higher pH value of the titration end point in the Modified procedure (pH 8.3) makes it more likely that the ferrous iron or manganese released in carbonate dissolution will be oxidized and hydrolyzed and not reported as NP. The BC Research Method (Section 13.3.5), which has an endpoint of 3.5, is the most likely bulk NP test to include ferrous iron or manganese carbonate in the measured NP (Lapakko, 1993).

A cost-effective procedure for measuring the proportion of iron and manganese carbonate, where this is an issue, is to use Rietveld analysis of XRD data to quantify the proportion of different carbonate minerals and electron microprobe analysis to ascertain the proportion of Fe, Mn, Ca and Mg in carbonate minerals such as ferrous dolomite and ankerite with a variable composition (Chapter 17).

#### 13.3.6.3 Plot CO<sub>3</sub>-NP versus Bulk NP

A comparison of CO<sub>3</sub>-NP and bulk-NP values can provide useful information about potential NP sources and the NP capacity of the carbonate minerals (Figure 13.4).

- Bulk NP values are typically 5 to 20 kg Ca CO<sub>3</sub> eq / tonne higher than the CO<sub>3</sub>-NP (Price and Kwong, 1997).
- If the CO<sub>3</sub>-NP is equal to or higher than the bulk NP, this indicates that either insufficient acid was added in the bulk-NP analyses or a measurable portion of the inorganic carbon is not generating alkalinity. The latter suggests either the presence of iron or manganese carbonates or the presence of organic matter. These possibilities should be evaluated before CO<sub>3</sub>-NP is used as a measure of the rapidly available neutralization capacity.
- If the bulk NP is higher than the CO<sub>3</sub>-NP, this indicates that the bulk NP includes neutralization from aluminosilicate minerals or there is an analytical error. Because of the potentially slow reaction rate and multiple possible sources of aluminosilicate alkalinity, mineralogical and kinetic data regarding the aluminosilicate sources and their reactivity relative to the rate of acid generation should be evaluated, before concluding that laboratory measured aluminosilicate NP will contribute to effective NP.

### 13.4 Conclusions

Equilibrium control of acid neutralization by carbonate mineral dissolution provides an immediate response. In contrast, kinetic control of acid neutralization by aluminosilicates weathering is relatively slow. Also, equilibrium and kinetic controls of acid neutralization by

hydroxide mineral dissolution can provide a faster response than aluminosilicates but neutralization occurs at an acidic pH.

NP information requirements for drainage chemistry prediction and material characterization can usually be met by the following procedures:

- two static laboratory NP measures;
  - an acid titratable bulk NP and
  - a CO<sub>3</sub>-NP measure;
- detailed mineralogical characterization (Chapter 17); and
- humidity cell testing (Chapter 18).

Interpretation of NP data requires knowledge of:

- type, location, exposure, concentration and reactivity of minerals with NP;
- future physical and hydrological conditions;
- the rate of acid generation; and
- limitations of the test procedures.

This information will allow proponents to:

- identify potentially important carbonate and aluminosilicate minerals;
- estimate the magnitude and effectiveness of minerals as NP sources;
- correct static test measures of NP for contributions from iron and manganese carbonates and insufficiently reactive aluminosilicate NP; and
- choose the procedures and correction factors required for operational material characterization.

Without at least both the bulk acid titratable and carbonate NP analyses, a realistic estimate of the effective NP and any correction factors are difficult to determine. Short cuts are only possible after thorough analysis to determine whether they are possible.

The procedures and correction factors used for operational material characterization will depend on the prediction questions and the neutralizing minerals. Often both bulk acid titratable and carbonate NP analyses should be used in operational material characterization.

Mineralogical data will reduce the risk of errors in NP assessment. No matter what NP procedure is used, information regarding the NP mineralogy and the sulphide oxidation rates are required to interpret the results and estimate effective NP.

*Minimum time required is less than half an hour for the CO<sub>3</sub>-NP from total-C, 18 hours for CO<sub>3</sub>-NP from the difference between total-C and organic-C, around 3 to 4 hours for Sobek NP and 25 hours for the Modified NP.*

It is important to consider all the information requirements and analysis constraints when selecting NP analyses. Time required may be an important consideration in the selection of NP analyses, especially NP analyses used for process control or operational material segregation (Sections 4.3.1 and 7.11.9.4). Minimum time

required is less than half an hour for the  $\text{CO}_3$ -NP from total-C, around 3 to 4 hours for the Sobek NP and 25 hours for the Modified NP. Measurement of  $\text{CO}_3$ -NP from the difference between total-C and organic-C takes about 18 hours, as the residue needs to be dried overnight. The speed of  $\text{CO}_3$ -NP analysis from total-C makes it an attractive analysis for process control where there is no Fe and Mn carbonate. The speed of the analysis of the Modified bulk NP procedure (25 hours), especially if the analysis must be rerun (50 hours) may be impractical for operational material characterization.

There may be problems with data consistency and the relationship between laboratory and effective NP, if different NP methods are used for different phases of the prediction program. The NP data gathered from different methods may not be directly comparable and work should be undertaken to understand and document any differences. Using different methods for pre-development NP prediction and operational material characterization can cause problems with data consistency.

### 13.5 References

Coastech Research Inc. 1989. Investigation of Prediction Techniques for Acid Mine Drainage MEND Project 1.16.1 a.

Frostad, S., W.A. Price and H.G. Bent. 2003. Operational NP Determination – Accounting for Iron Manganese Carbonates and Developing a Site-Specific Fizz Rating. In: Proceedings of Sudbury 2003: Mining and the Environment Conference, Sudbury, Ontario, May 24-29.

Jambor, J.L. 2003. Mine-Waste Mineralogy and Mineralogical Perspectives of Acid-Base Accounting - Chapter 5. In: J.L. Jambor, D.W. Blowes and A.I.M. Ritchie. (eds.) Environmental Aspects of Mine Wastes. Mineralogical Association of Canada Short Course Series, Volume 31.

Jambor, J.L. and J.E. Dutrizac. 2002. The Effect of Particle Size on the Neutralization Potential in Static-Test Prediction of Acid Drainage. In: B.C. Bjorkman, C. Samuelsson and J.O. Wikstrom (eds.) Recycling and Waste Treatment in Mineral and Metal Processing: Technical and Economic Aspects. Volume 2. The Mineral, Metals and Materials Society, Warrendale, Pennsylvania. pp. 651-663.

Jambor, J.L., J.E. Dutrizac and M. Raudsepp. 2005. Neutralization Potentials of Some Common and Uncommon Rocks, and Some Pitfalls in NP Measurements. In: Proceedings of the 12<sup>th</sup> Annual British Columbia – MEND Metal Leaching/Acid Rock Drainage Workshop, Challenges in the Prediction of Drainage Chemistry. Vancouver, British Columbia, November 30-December 1.

Jambor, J.L., J.E. Dutrizac and T.T. Chen. 2000. Contributions of Specific Minerals to the Neutralization Potential in Static Tests. In: Proceedings of the Fifth International Conference on Acid Rock Drainage, Denver, Colorado.

Jambor, J.L., J.E. Dutrizac, L.A. Groat and M. Raudsepp. 2002. Static Tests of Neutralization Potentials of Silicate and Aluminosilicate Minerals. Environ. Geol. 43: 1-17.

- Lapakko, K. 1993. Evaluation of Tests for Predicting Mine Drainage pH. Report to the Western Governor's Association. p. 76.
- Lawrence, R.W. and Y. Wang. 1996. Determination of Neutralization Potential for Acid Rock Drainage Prediction. MEND Project 1.16.3.
- Meek, F.A. 1981. Development of a Procedure to Accurately Account for the Presence of Siderite during Mining Overburden Analysis. In: Proceedings of West Virginia Surface Mine Drainage Task Force Symposium, Morgantown, West Virginia.
- Morin, K.A. and N.M. Hutt. 1994. Observed Preferential Depletion of Neutralization Potential over Sulfide Minerals in Kinetic Tests: Site-specific Criteria for Safe NP/AP Ratios. In: Proceedings of the Third International Conference on the Abatement of Acidic Drainage, Pittsburgh, Pennsylvania, USA, April 24-29, Volume 1. pp 148-156.
- Morin, K.A. and N.M. Hutt. 1997. Environmental Geochemistry of Minesite Drainage: Practical Theory and Case Studies. MDAG Publishing. p. 333.
- Morin, K.A. and N.M. Hutt. 2008a. A Case Study of Important Aluminosilicate Neutralization. MDAG Internet Case Study #25, [http://www.mdag.com/case\\_studies/cs25.html](http://www.mdag.com/case_studies/cs25.html) (revised and expanded February 2008).
- Morin, K.A. and N.M. Hutt. 2008b. Case Studies of Unavailable Neutralization Potential in Acid-Base-Accounting Datasets. MDAG Internet Case Study #30, [www.mdag.com/case\\_studies/cs30.html](http://www.mdag.com/case_studies/cs30.html).
- Morin, K.A. and N.M. Hutt. 2008c. Field Study of Unavailable Neutralization Potential in Acidic Rock. MDAG Internet Case Study #31, [www.mdag.com/case\\_studies/cs31.html](http://www.mdag.com/case_studies/cs31.html).
- Price, W.A. and Y.T.J Kwong. 1997. Guidelines for the Prediction of Acid Rock Drainage and Metal Leaching for Mines in British Columbia. Part III. Waste Rock Weathering, Sampling and Analysis: Observations from the British Columbia Ministry of Employment and Investment Database. In: Proceedings of the Fourth International Conference on Acid Rock Drainage, Vancouver, British Columbia, May 31 - June 6, 1997. Vol 1: 31-45.
- Skousen, J., J. Renton, H. Brown, P. Evans, B. Leavitt, K. Brady, L. Cohen and P. Ziemkiewicz. 1997. Neutralization Potential of Overburden Samples Containing Siderite. J. Environmental Quality. 26: 673-681.
- Smith, R.M., W.E. Grube, Jr., T. Arkle, Jr. and A. Sobek. 1974. Mine Spoil Potentials for Soil and Water Quality. EPA-670/2-74-070. U.S. Environmental Protection Agency, Cincinnati, Ohio.
- Sobek, A.A., W.A. Schuller, J.R. Freeman and R.M. Smith. 1978. Field and Laboratory Methods Applicable to Overburdens and Minesoils. Report EPA-600/2-78-054, U.S. National Technical Information Report PB-280 495.
- White, W.W., K.A. Lapakko and R.L. Cox. 1998. Effects of Protocol Variables and Sample Mineralogy on Static-test NP. In: Proceedings of the Eleventh Annual Conference of the Society of Mineral Analysts, Elko, Nevada, April 7-10.

## 14.0 ACID BASE ACCOUNTING AND CRITERIA USED TO PREDICT POTENTIAL FOR ACIDIC DRAINAGE

### *Some Important Points in this Chapter*

*Acidic drainage will only result when the rate of acid generation exceeds the rate of acid neutralization. Acid Base Accounting (ABA) is a series of analyses and calculations used to estimate the potential for mineral weathering to produce acidic drainage. ABA includes rinse and paste pH (Chapter 11), sulphur species and acid generation potential (AP, Chapter 12), and acid neutralization potential (NP, Chapter 13). Mineralogy (Chapter 17), elemental analyses (Chapter 10) and kinetic testing (Chapter 18) are also important for interpreting ABA results.*

*The rinse pH is indicative of the present drainage pH of a sample. Material categories for future drainage pH are potentially acidic drainage generating (PAG) and not potentially acidic drainage generating (Non-PAG). For cases where AP and NP are equally exposed and AP generates acid identical to pyrite and NP neutralizes acid like calcite, samples with an NPR less than 1.0 are PAG and samples with an NPR greater than 2.0 are non-PAG. A sample with an NPR between 1.0 and 2.0 is capable of generating ARD.*

*Site specific factors that may alter the relative magnitude of AP and NP include: AP and NP sources whose generation and neutralization of acid differs from pyrite and calcite, differences in AP and NP exposure and the location and length of flow paths. Other considerations in setting NPR criteria for PAG vs. Non-PAG are external sources of AP and NP and safety factors that account for limitations in the precision and accuracy of sampling, determination of the effective AP and NP and material handling.*

*The minimum AP, sulphide-S or acidic sulphate-S capable of causing ARD is not a generic number, but depends on the magnitude of the effective NP. A % S cut-off should not be used as the only means of assessing ARD potential unless the minimum NP value is known.*

*The onset of ARD may occur in a few years or take hundreds of years. The absence of ARD up to the present does not on its own prove that ARD will not occur in the future.*

*Criteria used to guide decisions regarding the potential for future acidic drainage are a key component of sound environmental and fiscal management. Drainage chemistry prediction should be conducted even for Non-PAG material because environmental impacts can also occur due to near-neutral and alkaline pH drainage.*

## 14.1 Introduction

The pH of drainage from sulphidic geologic materials is determined by the relative magnitudes of the rates of acid generation and neutralization. Acidic drainage will only result when the rate of acid generation exceeds the rate of acid neutralization. Potential sources and sinks for acid generation and neutralization include:

*Acidic drainage will only result when the rate of acid generation exceeds the rate of acid neutralization.*

- mineral weathering;
- external NP inputs such as lime additions during processing and alkalinity additions in dust and drainage;
- external acid inputs such as the acid from ammonium oxidation and acid in precipitation and runoff ; and
- losses of alkalinity in drainage.

The primary source of acid generation and acid neutralization is mineral weathering. Analyses and tests measuring the magnitude of acid generation and acid neutralization and weathering rates are used to predict whether sulphidic geologic materials are capable of generating acidic drainage in the future (Chapters 12, 13 and 18).

### 14.1.1 Acid Base Accounting and the Prediction of Drainage pH

Acid Base Accounting (ABA) consists of a series of compositional analyses and calculations used to estimate the potential for mineral weathering to produce acidic drainage if sampled sulphidic material is exposed to oxygen and water. ABA characteristics, particularly the Neutralization Potential Ratio (NPR), are used to identify and separate potentially acidic drainage generating (PAG) and not potentially acidic drainage generating (Non-PAG) material.

*Acid Base accounting (ABA) consists of a series of compositional analyses and calculations used to estimate the potential for mineral weathering to produce acidic drainage.*

Acid Base Accounting consists of:

- analysis of present pH (rinse pH for weathered material and crushed or paste pH for weathered and unweathered material);
- analysis of sulphur species and calculation of Acid Generation Potential (AP, Chapter 12);
- analysis of Acid Neutralization Potential (NP, Chapter 13); and
- calculation of neutralization potential ratio (NPR or NP/AP) and net neutralization potential (NNP or NP minus AP).

Mineralogy (Chapter 17), elemental analysis (Chapters 10 and 11), humidity cell (Chapter 18) test results, site specific weathering and leaching conditions, an understanding of the limitations of ABA test data and estimation of any external inputs and outputs of acidity and alkalinity (Chapters 6 and 7) are also important for interpreting ABA results and developing predictions.



### 14.1.2 Categories of Net Current and Potential Future Drainage pH

ABA test results may be used to predict the net current and potential future drainage pH. The net drainage pH is the overall drainage pH from a specified material. Materials, that if currently leached will produce acidic, near-neutral or alkaline pH values are respectively categorized as net acidic, net neutral or net alkaline. The rinse pH is indicative of the present drainage pH of a sample. Net acidic material is material whose effective NP has already been depleted. This subcategory is sometimes identified by the acronym AG.

Categories for potential future drainage pH are:

- potentially acidic drainage generating (PAG or potentially net acidic); and
- not potentially acidic drainage generating (Non-PAG or not-potentially net acidic).

Unless otherwise specified, these categories of potential future drainage pH assume exposure to oxidizing weathering conditions and sufficient time for complete oxidation of the sulphide minerals.

Potentially acidic drainage generating (PAG) material is presently net neutral or alkaline material

*Potentially acidic drainage generating (PAG) material is presently net neutral or alkaline material that is either predicted to become net acidic in the future or material whose future net drainage pH is uncertain.*

that is either predicted to become net acidic in the future or material whose future net drainage pH is uncertain. A material that is presently net neutral or alkaline will become net acidic in the future if the rate of acid neutralization is unable to keep up with the rate of acid generation. This may be due to a

decrease in the rate of acid neutralization or an increase in the rate of acid generation.

The rates of acid generation and neutralization are commonly linked, and an increase in the rate of acid generation will often increase the rate of acid neutralization. The rate of acid neutralization will be reduced and materials will become net acidic if minerals capable of maintaining a near-neutral pH (effective NP - Chapter 13) are exhausted prior to the completion of acid generation. Changes in the rates of acid generation and neutralization may also result from changes in weathering conditions or the relative surface area exposure of acid generating and neutralizing minerals. The objective of mitigation is often to change weathering conditions. Mitigation measures, such as flooding, that reduce the rates of sulphide oxidation and acid generation may prevent PAG material from becoming acidic in the future.

Not potentially acidic drainage generating (Non-PAG or not-potentially net acidic) material is presently net-neutral or alkaline, and predicted to continue to produce near-neutral or alkaline pH drainage in the future.

Materials will continue to be net neutral or alkaline if the rate of acid neutralization keeps up with the acid additions, and sources of acid generation are exhausted prior to the sources of acid neutralization. Some regions, grains or fracture surfaces of mine components or samples producing net alkaline or near-neutral may produce acidic drainage. Some regions of acidic weathering may increase metal concentrations in net alkaline or near-neutral drainage.

A material may be classified as having an uncertain future net drainage pH due to inadequate test work or geochemical conditions, such as an NPR between 1 and 2 (discussed below), where test work is unable to resolve whether acidic drainage will occur in the future.

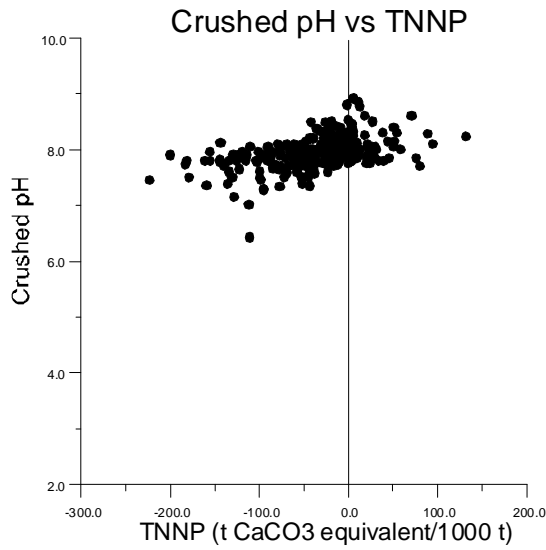
### 14.1.3 Net Neutralization Potential (NNP) and Neutralization Potential Ratio (NPR)

The net neutralization potential (NNP) and neutralization potential ratio (NPR) are calculated from the acid neutralization potential (NP) and acid generation potential (AP). NAG tests measure combined features of the acid neutralization potential (NP) and acid generation potential (AP) (Chapter 15).

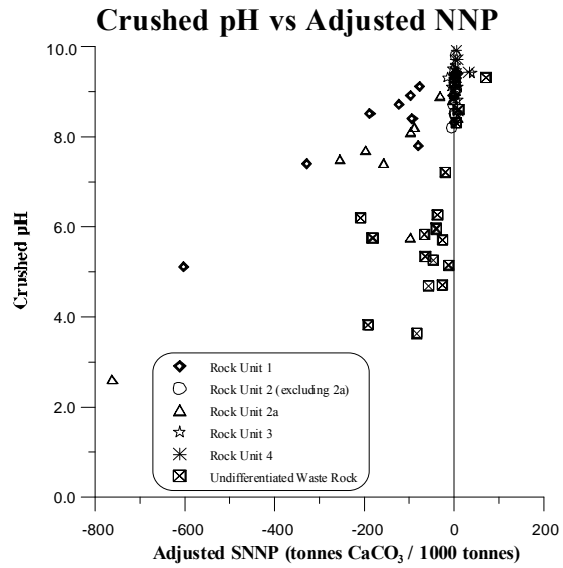
The net neutralization potential (NNP) is calculated by subtracting the acid generation potential from the acid neutralization potential (i.e.  $NP - AP$ ), expressed in units of kg  $\text{CaCO}_3$  equivalent per tonne.

The neutralization potential ratio (NPR) is calculated by dividing the acid neutralization potential by the acid generation potential (NP divided by AP), which becomes dimensionless (i.e. no units).

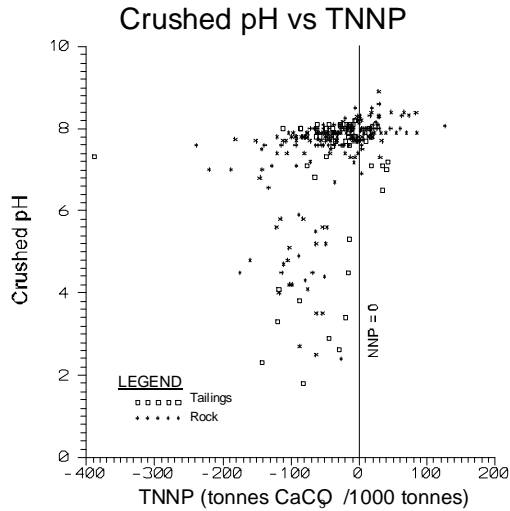
Plots of the NPR and NNP with other Acid Base Accounting parameters and with each other are shown in Figures 14.1 to 14.5. In these figures, the prefix “T”, like TNPR, indicates the NPR was calculated from total sulphur, and “S”, like SNNP, indicates it was calculated from sulphide.



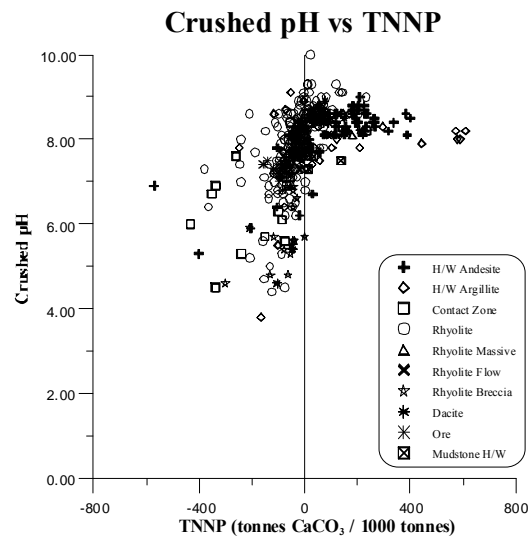
a) early stage of acid generation; no acidic samples



b) some samples with NNP < 0 acidic; some still neutral to alkaline

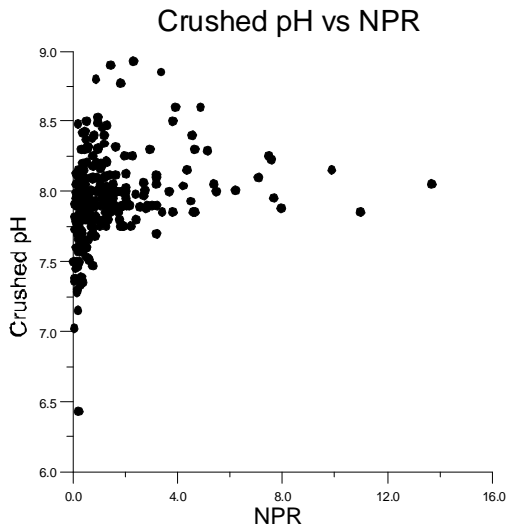


c) some samples with NNP < 0 acidic; some still neutral to alkaline

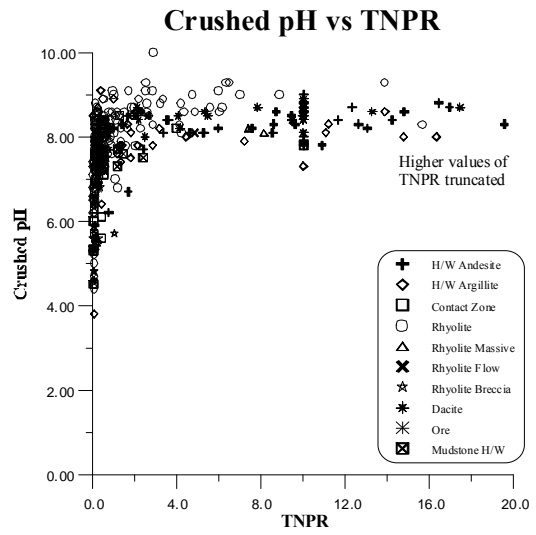


d) some samples with NNP < 0 acidic; some still neutral to alkaline

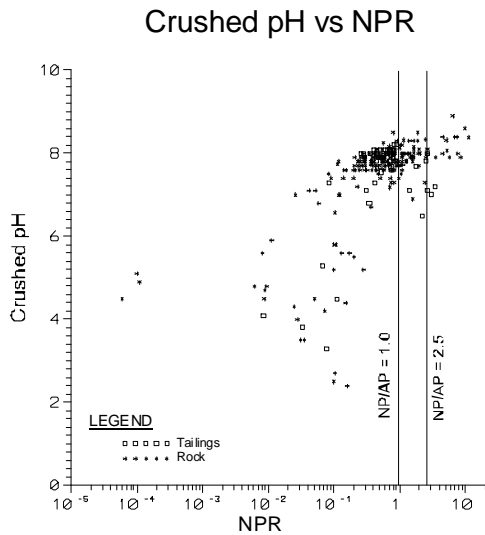
Figure 14.1 Scatterplots of NNP vs. crushed pH.



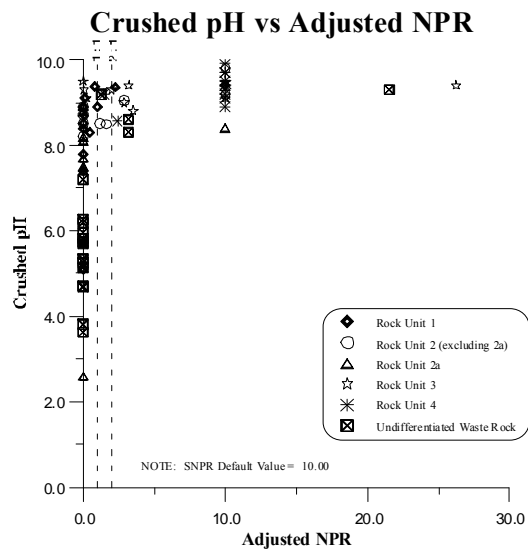
a) early stage of acid generation; no acidic samples



b) intermediate stage of acid generation; only a few samples with TNPR < 1.0 associated with acidic pH

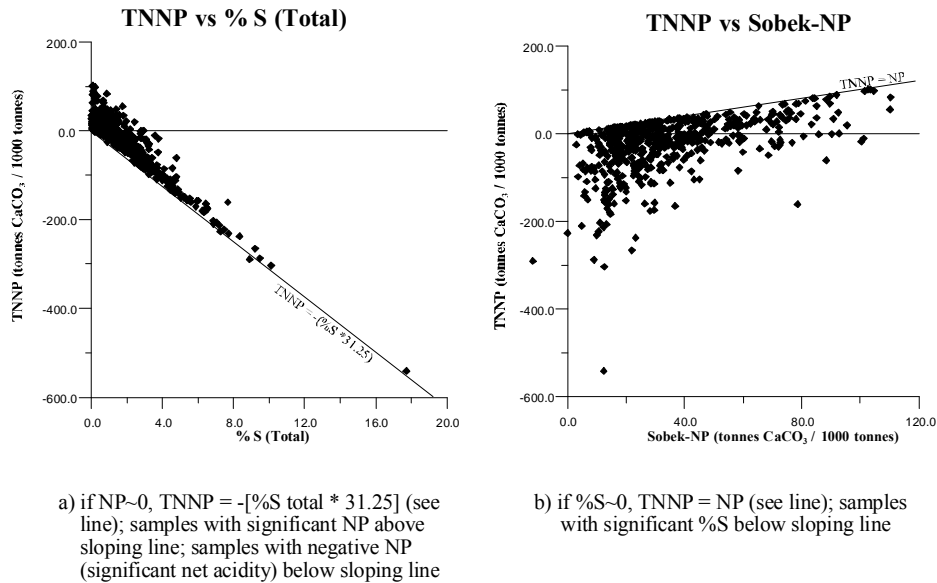


c) only samples with NPR < 0.3 have acidic crushed pH

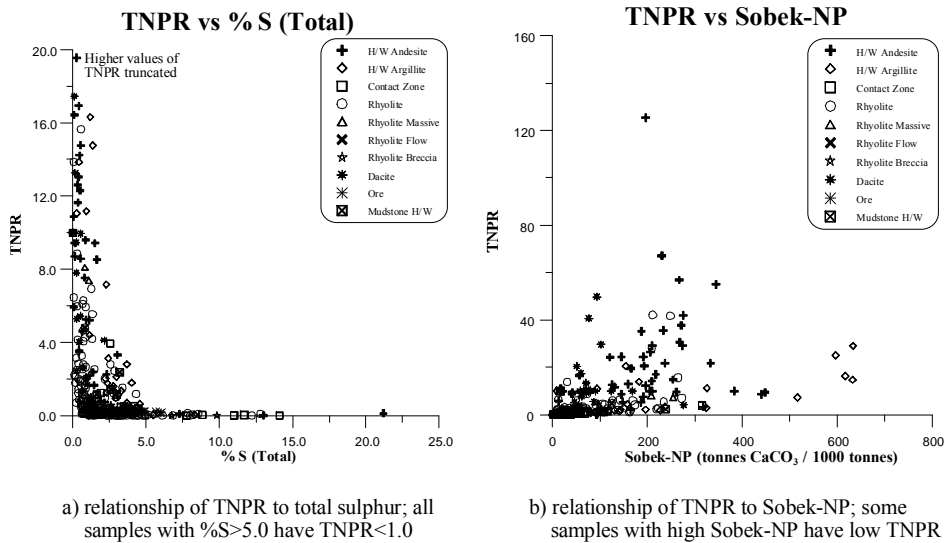


d) adjusted NPR values ~ 0 (unavailable NP subtracted) associated with acidic and neutral/alkaline pH

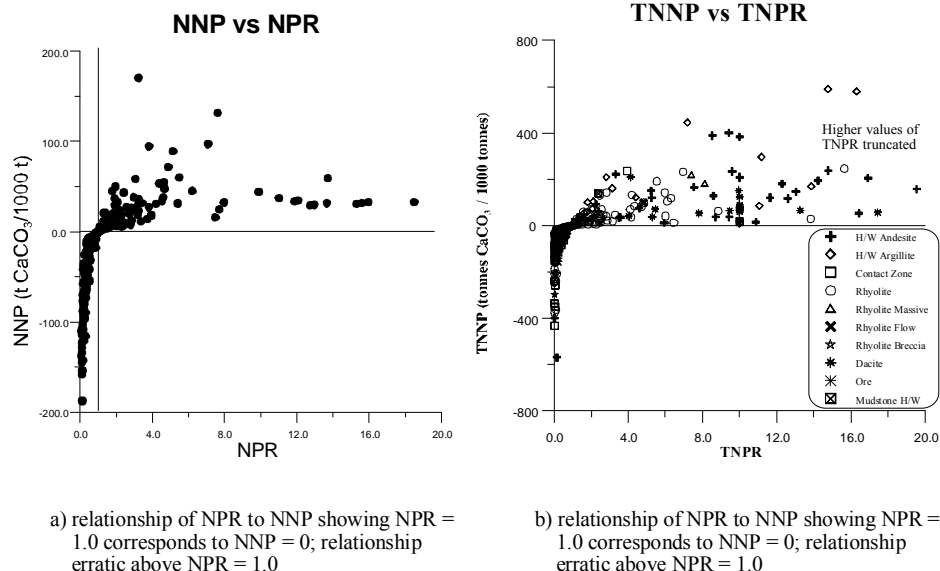
**Figure 14.2 Scatterplots of NPR vs. crushed pH.**



**Figure 14.3 Scatterplots of NNP vs. total sulphur and Sobek NP.**



**Figure 14.4 Scatterplots of NPR vs. total sulphur and Sobek NP.**



**Figure 14.5 Scatterplots of NPR vs. NNP.**

## 14.2 Criteria Used in the Prediction of Acidic Drainage

Criteria used to guide decisions regarding the potential for acidic drainage are a key component of sound environmental and fiscal management. Criteria used in the prediction of acidic drainage provide guidance regarding what information is required, how to interpret analytical results and how to classify materials. The objective of these criteria is to be both accurate and cost-effective. Challenges include the many properties and processes potentially contributing to drainage pH and the limitations of the predictive tools.

*Criteria used in the prediction of acidic drainage provide guidance regarding what information is required, how to interpret analytical results and how to classify materials.*

The following criteria are based on practical and theoretical (scientific) considerations (Price, 2005). Criteria may provide useful short cuts and enable cost-effective prediction but users always need to evaluate the underlying assumptions and limitations and whether criteria are compatible with the site specific conditions.

### 14.2.1 ABA Criteria for Determining Whether Material Will Produce Acidic Drainage and Segregating PAG and Non-PAG Material

Future pH depends on future relative rates and magnitudes of acid generation versus acid neutralization. Acidic drainage will result if acid neutralizing minerals are unable to keep up with the rate of acid generation often because acid neutralizing minerals are exhausted prior to completion of acid generation reactions.

If the effective AP is less than the effective NP, acidic drainage is never produced. If the effective AP is greater than the effective NP, acidic drainage will be produced, with the delay (time to ARD onset) depending on the magnitude and rate of NP depletion.

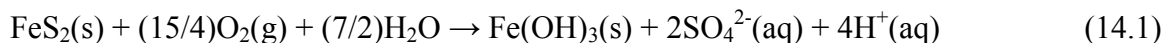
The future balance between acid generating and neutralizing reactions is indicated by the neutralization potential ratio (effective NP/AP = NPR). Results for the NP and AP are both reported as kg CaCO<sub>3</sub> eq / tonne. NP is determined by analysis. The effective NP can be determined with correction factors to remove the contribution of analytical NP sources incapable of maintaining a near-neutral pH under the site specific conditions (Chapter 13).

The AP is determined from the analysis of % sulphur in acid generating sulphur containing species (Chapter 12). The AP is calculated from the % sulphur in acid generating sulphur containing species as follows:

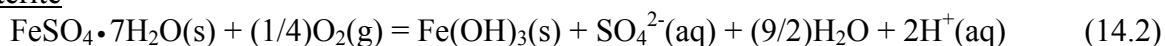
$$\text{AP (kg/t)} = \% \text{ sulphur} \times 31.25$$

The calculation for AP (%S x 31.25) is based on the following reactions in which 2 moles of H<sup>+</sup> are produced per mole of sulphide or acidic sulphate-sulphur and each mole of calcite neutralizes 2 moles of H<sup>+</sup>.

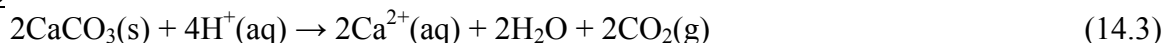
#### Pyrite



#### Melanterite



#### Calcite



The conversion factor of 31.25 is derived from:

$$\begin{aligned} & (2 \times \text{molecular weight of calcite} / 2 \times \text{molecular weight of sulphur}) \times (10) \\ & = (2 \times 100 / 2 \times 32) \times 10 \end{aligned}$$

Ten is the conversion factor from % to kg/tonne.

The effective AP can be determined with correction factors for the contribution of sulphur sources that will produce more or less than 2 moles of H<sup>+</sup> per mole of sulphur (see Chapter 5).

Reaction 14.3, which is used in the calculation of AP, is the reaction for calcite at pH < ~ 6.3 and open to gas exchange. Reaction 14.3 suggests an NPR < 1 is required for ARD because one mole of CaCO<sub>3</sub> neutralizes the two moles of acid produced by one mole of sulphide or sulphate-sulphur (see Chapter 5).

#### Calcite



Reaction 14.4 is the neutralization reaction for calcite that is predominant above ~ pH 6.3 to about pH 10. In Reaction 14.4, the 2 moles of H<sup>+</sup> per mole of sulphide or sulphate-sulphur

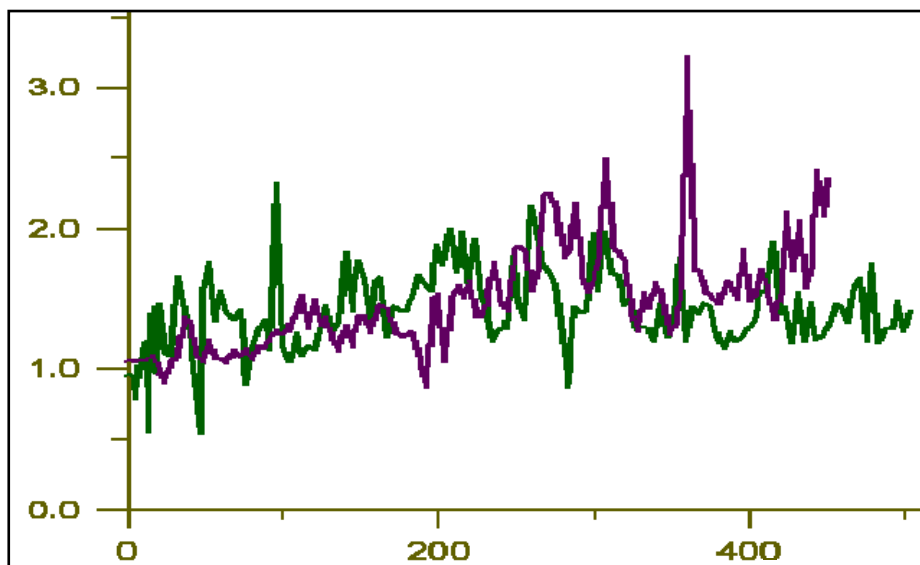
requires 2 moles of  $\text{CaCO}_3$  for neutralization. Reaction 14.4 suggests an  $\text{NPR} > 2$  is required to prevent ARD and reach a pH above  $\sim 6.3$ . These NPR criteria are affected to some extent by “open” exchange with, or “closed” isolation from,  $\text{CO}_2$  in the atmosphere and the degree to which alkalinity ( $\text{HCO}_3^-$ ) produced in Reaction 14.4 is retained and subsequently neutralizes acid.

Under near-neutral pH conditions, both Reactions 14.3 and 14.4 for calcite are likely to occur

*If acid potential generates acid identical to pyrite and neutralization potential reacts like calcite, then the NPR required to generate ARD will be between 1.0 and 2.0.*

under open or closed conditions and thus the NPR required to generate ARD will be between 1.0 and 2.0. This is why the ratio of NP depletion (moles of  $\text{Ca} + \text{Mg}$ ) to AP depletion (moles of sulphate) measured in a humidity cell is

typically between 1 and 2 (Figure 14.6) unless the rate of sulphate production falls below a minimal level. In other words, this molar ratio of  $(\text{Ca} + \text{Mg})/\text{SO}_4$  indicates the relative rate at which carbonate based NP is being consumed and a sample will eventually become acidic at an NPR value below this.



**Figure 14.6 Molar ratio of  $(\text{Ca} + \text{Mg})/\text{SO}_4$  representing sample specific NPRs (y-axis) versus time in weeks for two humidity cells.**

Criterion: Sample is PAG if  $\text{NPR} < 1$ . This criterion is true if there are no “errors” in the estimation of effective NP and AP. Possible errors include:

- acid generated from AP is neutralized by sources in addition to the NP;
- at a very low rate of sulphide oxidation, neutralization capacity of silicates may be underestimated by NP analyses because their reaction is too slow<sup>10</sup> to be completely measured by a relatively short period of acid digestion (Chapter 13);

<sup>10</sup> The rate of silicate reaction is commonly insufficiently reactive to neutralize acid sufficiently fast to maintain a near-neutral drainage pH.



- sulphur minerals containing the sulphur used to calculate the AP may generate  $< 2$  moles of acid per mole of sulphur (Chapter 12); and
- NP and AP measurements are made on whole samples (e.g. drill chips) of material in which NP is preferentially exposed on surfaces, while AP is buried within coarse particles.

Criterion: Sample is Non-PAG if  $NPR > 2$ . This criterion is true if there are no “errors” in the estimation of effective NP and AP. Possible errors include:

- NP is depleted by acid produced in processes other than by acidic sulphate dissolution or sulphide oxidation, which in well-flushed humidity cells can include NP dissolution by the excess water;
- NP produces less acid neutralization than calcite or is incapable of maintaining a near-neutral pH;
- sulphide or acid sulphate minerals may generate or release more than 2 moles of acid per mole of sulphur; and
- NP and AP measurements are made on whole samples (e.g. drill chips) of material in which AP is preferentially exposed on surfaces, while NP is buried within coarse particles.

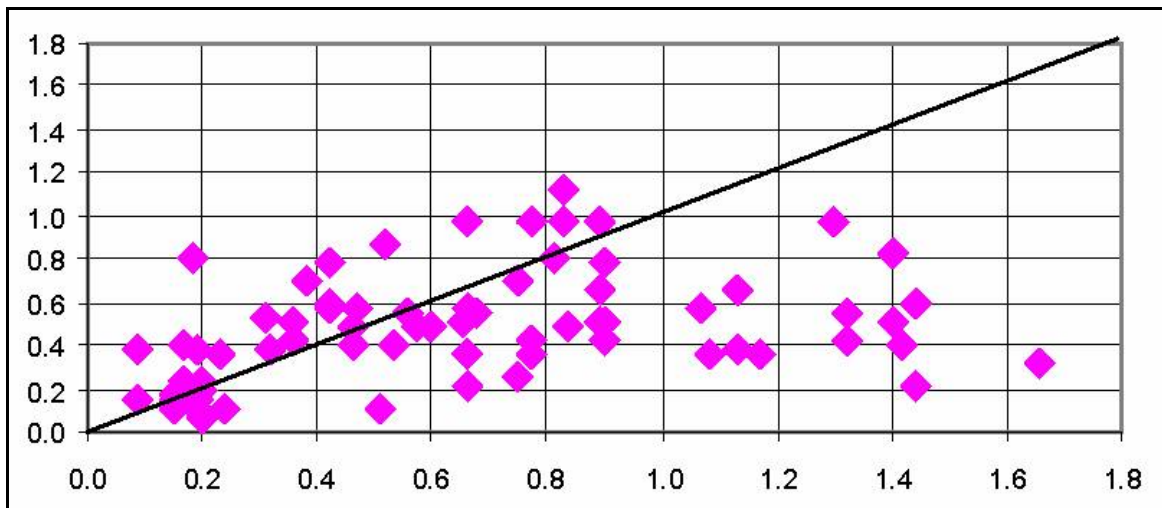
Criterion:  $1 \leq NPR \leq 2$ . Assuming no errors in the prediction of the effective AP and NP, the maximum NPR capable of generating ARD will be between 1 and 2. The classification of a sample with an NPR between 1 and 2 may remain “uncertain” until the NPR criterion is refined.

Accurate prediction of the future drainage pH requires consideration of the identity, location and reactivity of potentially acid generating and neutralizing minerals, future physical and geochemical conditions, external NP and AP inputs and outputs and an understanding of the NP and AP analytical procedures. ABA procedures that specify which criteria and which analyses are to be used in calculating the AP and NP, without due consideration for site specific factors, may produce errors if the selected analyses are insufficient or inappropriate for the site conditions. For example, ABA methods that use total sulphur for calculating the AP (Sobek et al., 1978 and AMIRA, 2002) may over estimate the potential for acidic drainage from materials where a portion of the sulphur is less acid generating than pyrite.

Although AP and NP values are important, other properties and processes may limit their contribution. Properties that may alter the relative contribution of acid generating and acid neutralizing minerals and can sometimes supersede the relative magnitude of the measured NP and AP include differences in AP and NP exposure and the location or length of flow paths (Morin and Hutt, 2008).

Factors that affect relative exposure include the relative distribution in different sized particles and blinding by precipitated secondary minerals. The NPR of reactive fines in a waste rock dump may differ from the NPR of pre-blast drill cuttings, on which day to day material segregation may be based. In Figure 14.7, a portion of the pre-blast drill chips had an NPR of 1 to 2, while the corresponding reactive fines in the waste rock had an NPR  $< 1$ . The difference between the composition of the pre-blast drill chips and the reactive fines in the waste rock is not significant because all the pre-blast samples had an NPR  $< 2$ , which was the criteria used at this site to identify post-blast PAG waste rock. However, the differences in composition between the

chips and fines would result in an “error” in NPR classification if the criteria used to identify post-blast PAG waste rock was a pre-blast chip NPR < 1.



**Figure 14.7 NPR of <2 mm fines in waste rock dump (y-axis) versus NPR of unsorted pre-blast drill cuttings.**

Physical breakdown of weathering coarse fragments will increase mineral exposure and may alter the NP:AP of reactive fines. Progressive physical breakdown may replenish the supply of exposed acid neutralizing minerals, delaying the onset of net acidic drainage.

Precipitation of iron or aluminum hydroxide produced by weathering may preferentially occur on and reduce the exposure of either acid generating or acid neutralizing minerals. Blinding of the surface by precipitated surface coatings of iron or aluminum hydroxide may reduce acid neutralization by limestone amendments in addition to existing carbonate minerals.

The flow path length may affect whether alkalinity ( $\text{HCO}_3^-$ ) produced in Reaction 14.4 is lost in the drainage or retained within the material and is capable of neutralizing AP. The flow path location may affect the degree to which different regions of a project component contribute to the overall chemistry of the discharged drainage. This could be very important if there is some form of segregation of NP and AP minerals such as the settling of heavier AP minerals on a well drained tailings beach.

Other considerations in setting NPR criteria for PAG vs. Non-PAG are listed below.

- Safety factors may be required to account for limitations in the precision and accuracy of sampling, determination of effective NP and AP, segregation and other aspects of material handling (Figure 14.8).
- External sources of AP and NP, such as acidity in precipitation and runoff and alkalinity in runoff and groundwater, can be significant and thus alter predictions.

- Sample locations, sample preparation, analytical procedures and methods of data interpretation should all be clearly identified when presenting Acid Base Accounting data and the predicted future drainage pH.
- Drainage chemistry prediction should be conducted even for  $\text{NPR} > 2$  because environmental impacts can also occur due to near-neutral and alkaline pH drainage.



**Figure 14.8 Safety factors may be required to account for limitations in the precision and accuracy of sampling, determination of AP and effective NP, data interpretation, segregation and other aspects of material handling.**

Because NPR provides a measure of the ratio between NP and AP, NPR criteria can be used over the wide range of AP values.

The net neutralization potential (NNP) calculated by subtracting the effective acid generation potential from the acid neutralization potential (i.e.  $\text{NNP} = \text{effective NP} - \text{AP}$ ) is additive and can only indicate whether the ratio of NP to AP is higher or lower than one. The NNP can provide potentially useful information in mitigation design, such as the lime required for an NPR of 1.0. The NNP is not recommended for use in characterizing the future potential for ARD because of its inability to indicate whether the ratio of NP to AP is between 1 and 2 or greater than 2.

#### **14.2.2 Minimum % S Capable of Causing ARD**

It is important to note that a % S cut-off should not be used as the only means of assessing ARD potential unless the minimum NP value is known. Even low levels of sulphide can lead to ARD if the NP is insufficient to neutralize the resulting acid.

It would be useful to conduct drainage chemistry prediction where geologic materials contain sulphide minerals, their weathering products and other reduced sulphur species regardless of whether there is a potential for acidic drainage because impacts can also occur due to near-neutral or higher pH drainage. There are examples of mines with near-neutral or higher pH drainage carrying out expensive long term drainage treatment to meet water quality objectives.

Future pH depends on the relative rate and magnitude of acid generation versus neutralization.

*The minimum AP, sulphide-S or acidic sulphate-S capable of causing ARD is not a generic number, but depends on the magnitude of the effective NP.*

The minimum AP, sulphide-S or acidic sulphate-S capable of causing ARD is not a generic number, but depends on the magnitude of the effective NP. For example, if the effective NP is 20 kg/t, < 0.3% sulphide-S will result in an NPR > 2, but an effective NP of 5 kg/t for the same % sulphide-S would result in an NPR < 1.

Very low levels of sulphide-sulphur may cause ARD if the NP is insufficient to neutralize the acid generation. At the East Kemptville Mine in Nova Scotia, humidity cell samples with 0.07 to 0.19% sulphide-S, NPR of 1 to 2 and NNP > 0 produced acidic drainage (Morin and Hutt, 2006).

Examples of rock matrices with a low NP include rock subjected to pervasive phyllic alteration or previous sulphide oxidation.

Materials with little or no NP and no sulphide may produce acidic drainage due to:

- residual acidic sulphate minerals from previous sulphide oxidation, which can be quickly detected by rinse and paste pH (Chapter 11);
- acid produced by oxidation of intermediary sulphur species such as thiosalts produced by previous sulphide oxidation;
- oxidation of ammonium from ammonium nitrate explosive or a by-product of cyanide degradation; and
- other sources of acidity such as organic acids and acid rain.

Great care is required when working with materials containing low AP and NP levels because minor variations can significantly alter the predicted and resulting drainage chemistry.

It is also important to recognize that impacts can occur due to near neutral or higher pH drainage. There are examples of mines with near-neutral or higher pH drainage conducting expensive long term drainage treatment to meet water quality objectives. The drainage chemistry from sulphidic geologic materials should be predicted regardless of whether there is a potential for acidic drainage.

### 14.2.3 Maximum Length of Time for ARD to Occur

“If this rock was ARD generating, we would have already seen ARD in the waste rock dumps, some of which are over 50 years old.” In reality, the current absence of ARD does not on its own prove that ARD will not occur in the future. The onset of ARD depends on the depletion of the effective NP. Localized or more pervasive depletion of the effective NP resulting in ARD may occur in a few years, or take hundreds of years. For example, physical changes to coarse fragments that expose new or fresh neutralizing minerals restart the clock in terms of the depletion of effective NP. Depletion of the effective NP before the AP, producing acidic drainage, will eventually happen if AP is greater.

*The onset of ARD depends on the depletion of the neutralizing minerals, a process that may take hundreds of years.*

Laboratory humidity cell testing coupled with ABA results provide rough estimates of NP depletion. For backfill in the Snip Mine of British Columbia, NP depletion of 5 kg CaCO<sub>3</sub> eq/tonne measured in cells would take 36 years to exhaust the NP of 180 kg/t. At colder temperatures, the depletion of neutralizing minerals required for onset of ARD may take longer.

Field tests and monitoring are needed to calibrate laboratory studies of NP depletion. It is therefore important to set up field test pads and check field weathering of materials at the site, such as material in older waste rock dumps and drill cores.

### 14.2.4 Conclusions Regarding Acidic Drainage Criteria

Analytical criteria for acidic drainage are a necessary and useful part of material characterization, but should be used with caution. Acidic drainage criteria should be based on comprehensive testing of the sulphidic geologic materials and a well-informed assessment of the results. Material may be misclassified if the underlying assumptions in the criteria are incorrect or ignored. The development and implementation of prediction programs and the interpretation of results can be technically demanding. Generic criteria cannot substitute for assessment by individuals with the appropriate motivation, technical training, experience and knowledge of the site.

Generic criteria should be adapted to fit the site specific conditions and based on analysis data that will be available in time to make management decisions. Sensitivity analysis and risk assessment should be used to determine the sufficiency of the site specific criteria and predicted drainage chemistry. Safety factors may be required to account for limitations in the precision and accuracy of material characterization, determination of the effective AP and NP and material segregation.

*Generic criteria should be adapted to fit the site specific conditions.*

The accuracy of analyses used to measure the AP and effective NP should be checked periodically (Chapters 12 and 13). An important part of this is mineralogical analysis performed to detect mineralogical differences (Chapter 17), such as the occurrence of iron carbonate that may cause errors in NP analyses. Checks should also be made of the magnitude of external sources of AP and NP, such as the acidity in precipitation and runoff and the alkalinity in the runoff and the groundwater.

The accuracy of material characterization will depend on the spatial variability in composition, the dimensions sampled, sample preparation and the sampling procedure and frequency (Chapter 8). More detailed sampling should be conducted periodically to determine the adequacy of the dimensions sampled and the sampling procedure and frequency. Preliminary sampling and analysis will be needed to determine the effectiveness of existing criteria for material characterization and segregation for new management units.

It would be useful to conduct drainage chemistry prediction even for Non-PAG material because environmental impacts can also occur due to near-neutral and alkaline pH drainage (Section 3.7).

### 14.3 References

AMIRA. 2002. ARD Test Handbook. AMIRA P387A Project. Ian Wark Research Institute and Environmental Geochemistry International Pty Ltd.

Guerin, F., S. Wilson and R. Nicholson. 2006. Optimizing In-Pit Disposal of Problematic Waste Rock Using Leaching Tests, Portable XRF, Block and Mass Transport Models. In: Proceedings of 13th British Columbia - MEND Metal Leaching/Acid Rock Drainage Workshop, Challenges with Open Pits and Underground Workings. Vancouver, British Columbia, November 29-30.

Morin, K.A. and N.M. Hutt. 2006. Is There a Solid-Phase Sulphide Level Below Which No ARD is Possible? MDAG Internet Case Study #21, [www.mdag.com/case\\_studies/cs21.html](http://www.mdag.com/case_studies/cs21.html).

Morin, K.A. and N.M. Hutt. 2008. Field Study of Unavailable Neutralization Potential in Acidic Rock. MDAG Internet Case Study #31, [www.mdag.com/case\\_studies/cs31.html](http://www.mdag.com/case_studies/cs31.html).

Price, W.A. 2005. Criteria Used in Material Characterization and the Prediction of Drainage Chemistry: "Screaming Criteria". In: Proceedings of 12th Annual British Columbia - MEND Metal Leaching/Acid Rock Drainage Workshop, Challenges in the Prediction of Drainage Chemistry. Vancouver, British Columbia, November 30 - December 1.

Sobek, A.A., W.A. Schuller, J.R. Freeman, and R.M. Smith. 1978. Field and Laboratory Methods Applicable to Overburdens and Minesoils. Report EPA-600/2-78-054, U.S. National Technical Information Report PB-280 495.

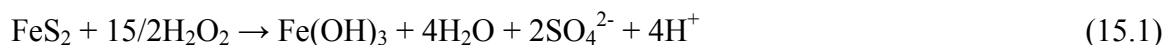
## 15.0 NAG TESTS

### *Important Points in this Chapter*

*Net Acid Generation or NAG tests use hydrogen peroxide (H<sub>2</sub>O<sub>2</sub>), a strong oxidizing agent capable of rapidly oxidizing sulphide minerals, to assess whether a sample is capable of neutralizing the potential acidity. NAG testing may involve a (1) single addition NAG test for low sulphide samples, (2) sequential NAG test for higher levels of sulphide, (3) partial ABA consisting of total sulphur, NP, and paste pH, (4) kinetic NAG test to obtain estimates of mineral reactivity and (5) acid buffering characteristic curve. The sequential NAG test should be conducted where the breakdown of the hydrogen peroxide due to reactions with sulphide surfaces, organic matter, sulphide oxidation products or other sources of reactive metals may incorrectly indicate the neutralizing capacity is large enough to maintain pH neutral to alkaline drainage.*

### 15.1 Introduction

Net Acid Generation or NAG tests use hydrogen peroxide (H<sub>2</sub>O<sub>2</sub>), a strong oxidizing agent capable of rapidly oxidizing sulphide minerals. The main purpose of these tests is to assess whether a sample is capable of neutralizing the potential acid produced by sulphide oxidation. Reaction 15.1 shows the oxidation of pyrite by hydrogen peroxide above ~pH 3.5.



Methods using oxidation by hydrogen peroxide to determine sulphide levels from acid production, after NP had been removed, have been available for decades (e.g. Sobek et al., 1978). This earlier test evolved to become a field or laboratory evaluation of whether a sample was potentially net acidic (net acid generation or NAG). NAG tests using hydrogen peroxide are now commonly used in Australasia for PAG classification and material segregation (Liao et al., 2007; Miller et al., 1997; Section 15.6).

As with other analyses (Chapters 12 to 13), without support from other tools like mineralogical analysis (Chapter 17), a simple hydrogen peroxide analysis was found to be inaccurate under some conditions and additional analyses and tests were added in recent years to create a more reliable suite of techniques (Shaw, 2005). These analyses and tests include:

1. measurement of the electrical conductivity and pH (Section 11.6);
2. partial ABA testing consisting of total sulphur, bulk NP, and paste pH measurements;
3. a sequential NAG test for samples with medium to high levels of sulphide;
4. a kinetic NAG test consisting of measurements of temperature, pH and electrical conductivity during a single NAG test;
5. creation of an acid buffering characteristic curve;
6. mineralogy; and
7. leach column testing (AMIRA, 2002).

The following descriptions of NAG methods are adopted from AMIRA (2002).

## 15.2 Single Addition NAG Test

The single addition NAG test involves the addition of 250 mL of 15% hydrogen peroxide. The objective of the single addition NAG test is to measure the pH and acidity after the sulphide is oxidized with hydrogen peroxide, which will depend on the acid produced and the reaction with acid-neutralizing materials (e.g. carbonates). The peroxide addition in the single addition NAG test is suitable for samples with less than 1.0% sulphide-sulphur and low concentrations of metals such as copper, which can catalyze the decomposition of hydrogen peroxide.

*A sample is considered PAG if NAG pH is < 4.5 and Non-PAG otherwise.*

According to AMIRA (2002), the NAG test should only be used as a stand alone test after it has been calibrated for a particular site. Calibration includes comparing single addition NAG with total sulphur NNP test results and developing a good understanding of the sulphide and carbonate mineralogy.

### 15.2.1 Method

#### Chemicals:

1. Sodium Hydroxide (NaOH) - 0.10 M and 0.50 M Standardized Solutions
2. Hydrogen Peroxide (H<sub>2</sub>O<sub>2</sub>) - Analytical Reagent 30% w/v (100 V), diluted 1:1 with deionized water to 15%. The presence of stabilizing agents (e.g. phosphoric acid) can seriously affect the NAG test result. The pH of the 15% hydrogen peroxide solution should be checked prior to use to ensure it is  $\geq$  pH 4.5. If the pH is < 4.5, then add dilute NaOH until the pH is > 4.5. The dilute NaOH solution is made up by adding 1 g NaOH to 100 mL of deionized water. Aim for a pH of 4.5 and not > 6.0. Record the pH of the H<sub>2</sub>O<sub>2</sub> reagent for each batch.

#### Method:

1. Grind the material to less than 200 mesh (< 75  $\mu$ m).
2. Accurately weigh approximately 2.5 gram of pulverized sample into a 500 mL conical beaker.
3. Use a 250 mL graduated cylinder to measure 250 mL of a solution of 15% H<sub>2</sub>O<sub>2</sub> (30% H<sub>2</sub>O<sub>2</sub> diluted 1:1 with deionized or distilled water) and carefully add the hydrogen peroxide to the conical flask. Note: The hydrogen peroxide should be at room temperature before commencing the test.
4. Place a watch glass on top of the beaker and place the beaker in a fume hood or well-ventilated area.
5. Allow the sample to react until "boiling" or effervescence ceases. This may require the sample to be left overnight. Note: The NAG reaction can be vigorous and NAG solutions can "boil over" if the reaction is too rapid.
6. After the reaction is completed, place the beaker on a hot plate. Gently heat the sample until effervescence stops or for a minimum of 2 hours to accelerate the oxidation of any remaining sulphides, then vigorously boil for several minutes to decompose residual peroxide. Note 1: Do not allow the sample to boil dry. Add deionized water as required to maintain a constant



volume. Note 2: 1 mL of 0.02 M-CuSO<sub>4</sub> can be added to the test mixtures prior to boiling to catalyze the decomposition of residual peroxide (O'Shay et al. 1990).

7. Allow the sample to cool to room temperature.
8. Rinse any sample that has adhered to the sides of flask into the solution using deionized water. Add deionized water to bring the final volume up to 250 mL.
9. Record the pH and EC of the solution. This pH measurement is referred to as the NAG pH.
10. Filter the sample. Retain the resulting NAG liquor for the titration step.
11. Titrate the NAG liquor solution to pH 4.5 and 7.0, while stirring, with the appropriate NaOH concentration based on the NAG pH as follows: 0.10 M NaOH when the NAG pH is > 2 and 0.50 M NaOH when the NAG pH is = 2. Note: Titration to both pH 4.5 and 7.0 is recommended to assist with the interpretation of the results. Titration to pH 4.5 accounts for acidity due to Fe, Al and most of the hydrogen ion. Any additional acidity accounted for in the titration between pH 4.5 and pH 7 is usually indicative of soluble metals such as Cu and Zn.

Additionally, the pre-titration NAG liquor solution may be analysed for other parameters (e.g. trace metals) to provide an indication of what other constituents of interest might be released and their solubility when the sample is oxidized in this manner.

#### Sample pH Classification:

- Non-acid forming (NAF): A sample is usually defined as NAF, or Non-PAG, when it has a final NAG pH > 4.5.
- Potentially acid forming (PAF): A sample is usually defined as PAF, or PAG, when it has a final NAG pH < 4.5.

The study conducted by Stewart et al. (2003) showed that NAG test oxidation of pyrite, pyrrhotite, arsenopyrite and chalcopyrite produced a final NAG solution with a pH < 4.5. Sphalerite, galena, bornite, chalcocite and covellite produced a final NAG solution with a pH > 4.5 due to the lack of hydrolysis of copper, lead and zinc below pH 4.5.

The acidity of the NAG liquor indicates the net amount of un-neutralized acidity produced per unit weight of sample. An indication of the form of the acidity is provided by initially titrating the NAG liquor to pH 4.5, then continuing the titration up to pH 7. The titration value at pH 4.5 includes acidity due to free acid (i.e. H<sub>2</sub>SO<sub>4</sub>) as well as soluble iron and aluminum. The titration value at pH 7 also includes metallic ions that precipitate as hydroxides at pH values between 4.5 and 7 and the acidity of hydrogen peroxide. The acidity from hydrogen peroxide will depend on the degree of decomposition but can be up to 20 kg CaCO<sub>3</sub> equivalents per tonne in each single additional NAG test (Stewart et al., 2003).

More extensive analysis of the NAG liquor can provide insight into potential contaminants of concern when the material is oxidized in this manner where there is limited kinetic testing and access to previously weathered material, such as core samples for new projects (Shaw, 2005). Like all laboratory tests, it is important to consider differences from field conditions when using this data.

### 15.2.2 Discussion of the Method

Advantages of the single addition NAG test are that it is relatively inexpensive and uses readily available chemicals and apparatus (Shaw, 2005). It is attractive as an operational characterization tool (e.g. for segregation of different material types) because it combines sulphide oxidation and acid neutralization into a single test.

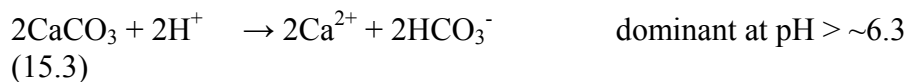
The single addition NAG test has a number of limitations (Shaw, 2005). The most important limitation is that the hydrogen peroxide may breakdown before it oxidizes all of the sulphides in a sample. Incomplete sulphide oxidation may underestimate the total acid generating potential and may incorrectly indicate that the neutralizing capacity is large enough to maintain pH neutral to alkaline drainage. According to AMIRA (2002), pyritic-S contents of < 1% were completely oxidized in the single addition NAG test, but those above 1% S were not. The breakdown of the hydrogen peroxide may be due to reactions with sulphide surfaces, organic matter, sulphide oxidation products or other sources of reactive metals. O'Shay et al. (1990) noted that organic matter, copper, lead and MnO<sub>2</sub> can catalyze the decomposition of hydrogen peroxide.

Most mine sites have rock types that may contain more than 1% sulphide-sulphur and elevated concentrations of organic matter or reactive metals. Measurement of sulphide-sulphur, neutralizing potential and reactive metals and an estimation of the organic matter content should be made to determine whether more than one hydrogen peroxide addition is needed (Section 15.3). The sequential multi-addition NAG test should replace the single addition test whenever high concentrations of bulk NP, total sulphur or constituents that catalyze a breakdown of peroxide may result in incomplete sulphide oxidation and a misleading NAG pH.

The reaction of hydrogen peroxide with samples containing high organic matter (>5-7% total organic carbon) may also interfere with the single addition NAG test. Organic acids produced by the reaction between hydrogen peroxide and high concentrations of organic matter may give a false measure of the acid potential. Analysis of the organic acid concentration in the reacted solution is needed to separate this type of acid from that produced by sulphide oxidation. Miller et al. (1997) recommended caution when analyzing coal wastes containing a high organic content.

Other potential weaknesses of the NAG test are a lack of consideration of elevated contaminants in non-acidic drainage, the pH criteria of 4.5 and the rapid acid generation. The pH criteria of 4.5 means that the Non-PAG classification will include weakly acidic or near-neutral samples capable of generating high concentrations of potentially toxic trace elements. An example of this is the high concentrations of zinc that occurs in weakly acidic and near-neutral mine drainage where sphalerite can galvanically suppress pyrite oxidization (Day et al., 2003). Rapid acid generation can lead to a very acidic pH that dissolves ferric iron, which can encapsulate and occlude neutralizing minerals before they are fully neutralized.

The addition of hydrogen peroxide at pH 4.5 and rapid sulphide oxidation in the test may create different weathering conditions and reactions than those expected under field conditions. For example, a lower pore water pH in the test may result in a lower rate of NP depletion per unit of sulphide oxidation than under field conditions since the acid neutralization reaction for carbonate minerals will depend on the pH. This is illustrated by Reactions 15.2 and 15.3, where Reaction 15.2 predominates below ~pH 6.3, and Reaction 15.3 predominates at higher pH values.



Thus, if the NAG pH ends at 5.5, it is predicted to be Non-PAG, but NP consumption would be up to twice as high if field pH is above 6.3. Without an independent value for the effective NP accompanying the single or sequential NAG test, it is also difficult to predict the lag time to the onset of net acidic conditions or the effect of inputs of acidity from other sources (Morin and Hutt. 1999).

### 15.2.3 Comparison of Single Addition NAG Test with NAG-NNP Results

AMIRA (2002) recommends that initial material screening include comparing the single addition NAG test and NAG-NNP results. The NAG-NNP is derived from an AP value calculated from a measurement of total sulphur and a bulk NP analysis similar to the Sobek procedure (Chapter 14). The NAG-NNP is the acid generation potential minus the acid neutralization potential (NNP = AP - NP), the opposite of the North American convention (NNP = NP - AP) and expressed in units of kg/tonne of H<sub>2</sub>SO<sub>4</sub> equivalents rather than CaCO<sub>3</sub> (Section 15.6). In the NAG screening procedure, a NNP > 0 is classified as PAG and a NNP < 0 is Non-PAG.

Discrepancies in PAG and Non-PAG classifications between single addition NAG and NAG-NNP results may result from the following:

- incomplete sulphide oxidation in the NAG Test (Section 15.2.2);
- organic acids produced by the reaction between hydrogen peroxide and organic matter in the NAG Test (Section 15.2.2);
- a portion of the total sulphur produced less acid than pyrite sulphur due to a lack of hydrolysis of the associated metals (Section 5.4 and 5.5); and
- a portion of the measured NP being incapable of acid neutralization above pH 4.5 (Chapter 13).

Incomplete sulphide oxidation in the single addition NAG test may result from a high sulphide content > 1% or the breakdown of the hydrogen peroxide due to reactions with sulphide surfaces, organic matter, sulphide oxidation products or other sources of reactive metals. Analysis of sulphate in the final solution is used by AMIRA (2002) to estimate the % total-sulphur oxidized in each phase of sequential NAG testing. Without detailed pre-test analysis of the sulphur species, especially the concentration of sulphate species, it is not safe to conclude that the sulphate in solution came from the oxidation of sulphide minerals rather than the dissolution of sulphate minerals (Chapters 12 and 18). The more detailed assessment of sulphur and NP species needed to estimate the portions of the total sulphur producing less acid than pyrite-sulphur and measured NP incapable of acid neutralization above pH 4.5 will likely preclude a need for the single or multiple addition NAG tests.

A potential source of error that will not be detected in a comparison of single addition NAG and NAG-NNP test results is that some acid neutralization by carbonate minerals will occur above

pH 6.3 in the field, increasing the rate of NP depletion per unit of sulphide oxidation (Reaction 15.3). Use of the NNP to predict the potential for net acidic conditions or total sulphur to calculate the NNP and NPR values is generally not recommended (Chapter 14).

### 15.3 Sequential NAG Test

Breakdown of the hydrogen peroxide due to reactions with sulphide surfaces, organic matter, sulphide oxidation products or other sources of reactive metals may result in incomplete sulphide oxidation in the single addition NAG test (Section 15.2). To overcome this problem, the multi-stage sequential NAG test, a series of single addition NAG tests on one sample, should be conducted.

A sequential NAG test is a series of single addition NAG tests on one sample.

Like the single addition NAG test, in the sequential NAG test, 2.5 g of sample is reacted two or more times with 250 mL aliquots of 15% hydrogen peroxide. At the end of each stage, the sample is filtered and the solution is used for measurement of NAG pH and NAG acidity. The resulting solid residue should be rinsed with deionized water to remove any excess, unreacted  $\text{H}_2\text{O}_2$ . The rinsed solid residue is then filtered and the liquor is discarded. The NAG test is then repeated on the solid residue. According to AMIRA (2002), the cycle should be repeated until there is no further catalytic decomposition of the peroxide and the NAG pH is  $>$  pH 4.5. An alternative end point could be when the NAG pH is  $<$  4.5, indicating that the sample is PAG.

AMIRA (2002) recommends comparing sequential NAG test results with a net neutralization potential (NNP) value calculated from total sulphur and a bulk NP analysis. Detailed assessment of sulphur and NP species and analysis of sulphate in the NAG solution can be used to estimate the number of cycles needed for complete sulphide oxidation or to produce a NAG pH of  $<$  4.5.

The overall NAG capacity of the sample is determined by summing the NAG acidity for each stage. The number of test stages before a sample turns acid will only roughly indicate the lag time to the onset of acidic drainage in the field. Good kinetic data is needed for a more accurate prediction.

The time consuming nature of the sequential NAG test may not be suitable for routine operational material characterization (AMIRA, 2002). This may make NAG testing impractical for projects where sulphide-sulphur may be more than 1.0% or where there is a concern regarding the breakdown of the hydrogen peroxide due to reactions with organic matter, sulphide oxidation products or other reactive metals.

### 15.4 Kinetic NAG Test

The kinetic NAG test is the same as the single addition NAG test except that the temperature, pH and/or electrical conductivity of the liquor are recorded as a function of time. Variations in these parameters during the test provides an indication of the kinetics of sulphide oxidation, acid generation and acid neutralization. For example, the pH trend gives an estimate of the relative mineral reactivity and may help to predict lag times and oxidation rates measured in leach columns (Chapter 19).

Reaction kinetics are influenced by the initial temperature of the reagents. It is therefore recommended that the initial temperature of the hydrogen peroxide be controlled at  $20^{\circ}\text{C} \pm 2^{\circ}\text{C}$ . Again, caution must be exercised with samples high in organic material content, since organic acid production in the NAG test can interfere with results.

### 15.5 Acid Buffering Characteristic Curve (ABCC) Test

The Acid Buffering Characteristic Curve (ABCC) test involves slow titration of a sample with acid while continuously monitoring pH. This data provides an indication of the portion of NP (also called Acid Neutralization Capacity or ANC) within a sample that is capable of acid neutralization at various pH levels. In this way, it is a more elaborate NP test than the BC Research and Lapakko methods that use single pH endpoints (Section 13.3.5). The ABCC test has value outside NAG testing, particularly as a means of determining the portion of any bulk NP measurement that is capable of acid neutralization and buffering the pH at various pH levels. The ABCC test is also useful in assessing whether a sulphidic sample with a NAG pH of  $\sim 4.5$  has enough readily available carbonate to render it Non-PAG.

*The ABCC test provides an indication of the portion of NP within a sample that is capable of acid neutralization at various pH levels.*

The methodology is as follows:

1. Accurately weigh 2.0 g of pulverized ( $< 75 \mu\text{m}$ ) sample and place it in a 250 mL conical flask and add 100 mL of deionized water.
2. Titrate the sample to pH 2.5 with incremental additions of hydrochloric acid while stirring continuously. See Table 15.1 for the appropriate strength and increment of acid.
3. After each addition, allow 1000 seconds for the pH to equilibrate and then record the pH.
4. Convert the HCl acid added to kg  $\text{CaCO}_3$  equivalent/tonne added as follows:  

$$\text{CaCO}_3 \text{ equivalent (kg/t)} = \text{HCl (ml) added} \times \text{Molar Conc.} \times 100/2 / \text{Sample Wt (g)}$$
5. Plot kg  $\text{CaCO}_3$  equivalent/tonne added (x-axis) against pH measured (y-axis) to obtain the buffering curve.

**Table 15.1 Suggested incremental additions and concentrations of HCl.**

NP of Sample ( $\text{CaCO}_3$ equivalent/tonne)	Concentration of HCl (Molar)	Increments of HCl (mL)
10	0.1	0.1
20	0.1	0.2
50	0.1	0.5
100	0.5	0.2
200	0.5	0.4
500	0.5	1.0
1000	0.5	2.0

## 15.6 Different Terms and Conventions Used in Australasia

AMIRA uses different terms and conventions to express Acid Potential (AP), Neutralization Potential (NP) and Acid Base Accounting (ABA). Australasia uses the units of H<sub>2</sub>SO<sub>4</sub> kg per tonne, while in North America the convention is to use CaCO<sub>3</sub> kg equivalent per tonne. Conventions for each region are presented below.

South Pacific Conventions:

Maximum Potential Acidity (MPA) =  $30.63 \times \% S = \text{kg H}_2\text{SO}_4 \text{ equivalent / tonne}$

Acid Neutralizing Capacity (ANC) = titrated value =  $\text{kg H}_2\text{SO}_4 \text{ equivalent / tonne}$

Net Acid Production Potential (NAPP) =  $\text{MPA} - \text{ANC} = \text{kg H}_2\text{SO}_4 \text{ equivalent / tonne}$

with positive NAPP values being

PAG

ANC/MPA Ratio (unit-less)

North American Conventions:

Acid Potential (AP) =  $31.25 \times \% S = \text{kg CaCO}_3 \text{ equivalent / tonne}$

Neutralization Potential (NP) = titrated value =  $\text{equivalent / tonne}$

Net Neutralization Potential (NNP) =  $\text{NP} - \text{AP} = \text{equivalent / tonne}$

Negative values are potentially acid generating

Net Potential Ratio (NPR) =  $\text{NP/AP}$  (unit-less)

Conversion Factors:

$\text{ANC} = 0.98 \times \text{NP}$

$\text{MPA} = 0.98 \times \text{AP}$

Conversions are based on the ratio of molecular weights of H<sub>2</sub>SO<sub>4</sub> and CaCO<sub>3</sub>.

## 15.7 References

AMIRA. 2002. ARD Test Handbook. AMIRA P387A Project. Ian Wark Research Institute and Environmental Geochemistry International Pty Ltd.

Day, S., W. Kuit and M. Filion. 2003. Evolution of Mine Drainage Chemistry, Red Dog Mine, Alaska. In: Proceedings of the 10th Annual British Columbia - MEND Metal Leaching/Acid Rock Drainage Workshop, Performance of ARD Generating Wastes, Characterization of Wastes and Recent MEND Projects. Vancouver, British Columbia, December 2-3.

Liao, B., L.N. Huang, Z.H. Ye, C.Y. Lan and W.S. Shu. 2007. Cut-off Net Acid Generation pH in Predicting Acid-Forming Potential in Mine Spoils. J. Environ. Qual. 36: 887-891.

Miller, S., A. Robertson and T. Donohue. 1997. Advances in Acid Drainage Prediction using the Net Acid Generation (NAG) Test. In: Proceedings of the Fourth International Conference on Acid Rock Drainage, Vancouver, British Columbia, May 31-June 6. Vol. 2: 533-547.

Morin, K.A. and N.M. Hutt. 1999. Comparison of NAG Results to ABA Results for the Prediction of Acidic Drainage. MDAG Internet Case Study #10, [www.mdag.com/case\\_studies/cs1-99.html](http://www.mdag.com/case_studies/cs1-99.html).

O'Shay, T., L.R. Hossner and J.B. Dixon. 1990. A Modified Hydrogen Peroxide Oxidation Method for Determination of Potential Acidity in Pyritic Overburden. *J. Environ. Qual.* 19: 778-782.

Shaw, S. 2005. Case Studies and Subsequent Guidelines for the Use of the Static NAG Procedures. In: Proceedings of 12th Annual British Columbia - MEND Metal Leaching/Acid Rock Drainage Workshop, Challenges in the Prediction of Drainage Chemistry. Vancouver, British Columbia, November 30 - December 1.

Sobek, A.A., W.A. Schuller, J.R. Freeman and R.M. Smith. 1978. Field and Laboratory Methods Applicable to Overburdens and Minesoils. Report EPA-600/2-78-054, U.S. National Technical Information Report PB-280 495.

Stewart, W., S. Miller, R. Smart, A. Gerson, J. Thomas, W. Skinner, G. Levay and R. Schumann. 2003. Evaluation of the Net Acid Generation (NAG) Test for Assessing the Acid Generating Capacity of Sulfide Minerals. In: Proceedings of the Sixth International Conference on Acid Rock Drainage, Cairns, Australia. pp. 617-625.





## 16.0 PARTICLE SIZE SEPARATION AND ANALYSIS

### *Some Important Points in this Chapter*

*Particle size distribution of sulphidic geologic materials can play an important role in drainage chemistry prediction because of its effects on mineral reactivity and the movement of water and gases. These effects result from the relationships among particle size, pore size, grain exposure and exposed surface area. For example, a waste rock boulder may contain a much higher concentration of hard minerals like quartz and K-feldspar, while softer minerals like calcite, gypsum and phyllosilicates are concentrated in the finer size fractions. Geometric surface area, based on particle size distributions, can be calculated from equations in textbooks or by free software.*

### 16.1 Introduction

Particle size distribution of sulphidic geologic materials can play an important role in drainage chemistry prediction because of its effects on mineral reactivity and the movement of water and gases (Chapters 5 and 7). These effects result from the relationships among particle size, pore size, grain exposure and exposed surface area. For example, in large particles (coarse fragments)

*Particle size distribution of sulphidic geological materials can play an important role in drainage chemistry prediction.*

most of the mineral grains are physically occluded and denied access to oxygen and water and are thus unable to react. For many chemical processes, the larger the surface area the higher the reaction rates per unit mass. There is typically an exponential increase in mineral exposure (surface area) with an exponential decrease in particle size (Birkeland, 1974). The particle size distribution may be especially critical if the relative proportion of important minerals varies from the finer to the coarser sized particles.

Factors that will determine the particle size distribution and the proportion of fines in a waste rock dump include:

- features of the blast;
- methods of materials handling, including deposition;
- the strength and competency of the rock; and
- weathering.

Compositional differences between particle size fractions will result from the following:

- skewed or selective release of different primary minerals, as a result of their strength, cohesion and distribution in the original rock, during initial mining and from later weathering of coarser particles;
- weathering effects causing the preferential removal of primary minerals and the accumulation of secondary minerals and surface coatings in finer particle size fractions; and
- grain size, which may provide a lower limit on the particle size in which a mineral may exist.

For example, a waste rock boulder may contain a much higher concentration of hard minerals like quartz and K-feldspar, while softer minerals like calcite, gypsum and phyllosilicates are concentrated in the finer size fractions. Phenocrysts like quartz and K-feldspar will be largely absent from the < 50  $\mu\text{m}$  size fraction, which will mainly consist of softer, silt size minerals like the phyllosilicates. In some cases it is the lack of cohesiveness between grains that causes their preferential occurrence in the finer particle size fractions. The effect of softness, grain size and spatial distribution in the original rock may play a significant role in the eventual location and consequent reactivity of different sulphide minerals.

*The effect of softness, grain size and spatial distribution in the original rock may play a significant role in the eventual location and consequent reactivity of different sulphide minerals.*

Particularly at metal mines, much of the waste rock remains isolated in competent, coarse fragments. Samples taken from existing waste dumps should be sieved to permit separate geochemical analysis of the fine fraction (Chapter 8).

Information on particle size distribution, particle surface area and the associated properties of structure and particle strength, can come from the following:

- records of the methods of deposition, the masses, and when and where different geological types and waste materials were placed; and
- observations of structural features, particle size distribution, segregation of different sized particles and particle strength, and the analysis of samples from the surface and test pits.

### 16.1.1 Methods of Analysis

Methods for measuring the particle size distribution and separating different particle size fractions for analysis include dry and wet sieving, differential liquid settling procedures, optical scanning and laser diffraction methods (Kroetsch and Wang, 2008). The proportion of small stone to silt sized particles can be measured by mechanical sieving, timed settling and optical scanning procedures. The surface area of the less than small stone size particles can be measured using gas absorption techniques such as BET, visually determined using a SEM, or estimated from the particle size distribution by making assumptions about the particle shape and using freely available computer programs.

Dry sieving can separate > 62.5  $\mu\text{m}$  particle size fractions. It can therefore be used to separate material into fractions, such as stones (> 12.7 mm), gravel (2 - 12.7 mm), soil (< 2 mm) and sand (> 2 mm - 62.5  $\mu\text{m}$ ) sized particles and then measure their % by weight. Stacks of sieves on a mechanical shaker can be used to divide samples into various size fractions. Many laboratories use the ASTM C136-06 Standard Test Method for Sieve Analysis of Fine and Coarse Aggregates.

Wet sieving is required to separate silt and clay (< 62.5  $\mu\text{m}$ ) sized particles from larger > 62.5  $\mu\text{m}$  particles. The ASTM procedure is ASTM C117-04 Standard Test Method for Materials Finer than 75  $\mu\text{m}$  (No. 200) Sieve in Mineral Aggregates by Washing.

Differential liquid settling procedures can use visible light or optical density to determine the particle size distribution, and to separate different < 62.5  $\mu\text{m}$  particle sizes fractions, such as silt

(2 - 62.5  $\mu\text{m}$ ) and clay (< 2  $\mu\text{m}$ ) sizes. Automated scanning with an electron microscope or laser diffraction methods can determine the particle size distribution of microscopic particles.

The procedure for particle size analysis should be chosen according to the particle size range and the proposed use of the data. Methodology (Sections 16.2 and 16.3) is provided in this Manual for the separation of:

- soil, gravel and stones; and
- sand from silt and clay.

In both procedures the particles are separated using a nest of sieves. The duration of sieving will depend, to a degree, on the sample size and the sensitivity of the particles to abrasion. Reducing the sample size is a preferred option to prolonged sieving. For similar weights, more sieving time may be required for smaller particles because of the progressive reduction in the percentage of open area as the aperture size decreases. According to Allen (1981), for routine control purposes, the cut-off for machine sieving is recommended to be 20 minutes or a 1% per minute rate fall. Standardization of the procedure is crucial if one is to get reproducible results.

Table 16.1 lists the size of the mesh openings for the U.S. Sieve Size and Tyler Mesh. The Tyler mesh size is a measure of the openings per linear inch in a sieve. The mesh opening is used to name sieves whose mesh opening is larger than those with Sieve Size and Tyler Mesh numbers (e.g. 12.7 mm or  $\frac{1}{2}$  in. sieve).

## 16.2 Separation of Soil, Gravel and Stone Size Fractions

### Materials

1. 250 g or more of air dried sample.
2. 12.7 mm ( $\frac{1}{2}$  in) and 2 mm sieves; all screens should be stainless steel as brass sieves can cause trace element contamination.

### Method

1. Ensure that all screens to be used for samples that will be chemically analyzed are clean and made of stainless steel.
2. Prior to starting separation, record the total weight of the sample and each of the screens.
3. Dry sieve for 5 to 20 minutes. Greater time periods may cause significant particle comminution and abrasion.
4. Record the resulting weights of each screen. Calculate the weights for each of the following size fractions:
  - > 12.7 mm ( $\frac{1}{2}$  in) stones
  - 2 – 12.7 mm gravel
  - < 2 mm soil

Table 16.1 Standard sieve mesh sizes<sup>1</sup>

U.S. Sieve Size	Tyler Mesh	Inches	Microns	Millimeters
	1 in.	1.0000	2540	25.400
	½ in.	0.5000	1270	12.700
	¼ in.	0.2500	6350	6.350
3		0.2650	6730	6.730
	3.5	0.2330	5660	5.660
4	4	0.1870	4760	4.760
5	5	0.1570	4000	4.000
6	6	0.1320	3360	3.360
7	7	0.1110	2830	2.830
8	8	0.0937	2380	2.380
10	9	0.0787	2000	2.000
12	10	0.0661	1680	1.680
14	12	0.0555	1410	1.410
16	14	0.0469	1190	1.190
18	16	0.0394	1000	1.000
20	20	0.0331	841	0.841
25	24	0.0280	707	0.707
30	28	0.0232	595	0.595
35	32	0.0197	500	0.500
40	35	0.0165	400	0.400
45	42	0.0138	354	0.354
50	48	0.0117	297	0.297
60	60	0.0098	250	0.250
70	65	0.0083	210	0.210
80	80	0.0070	177	0.177
100	100	0.0059	149	0.149
120	115	0.0049	125	0.125
140	150	0.0041	105	0.105
170	170	0.0035	88	0.088
200	200	0.0029	74	0.074
230	250	0.0024	63	0.063
270	270	0.0021	53	0.053
325	325	0.0017	44	0.044
400	400	0.0015	37	0.037

Adapted from

<sup>1</sup>[http://www.temp-foam.com/engineering/conversion\\_charts/conversion\\_chart\\_mesh\\_inches\\_microns\\_millimeters.htm](http://www.temp-foam.com/engineering/conversion_charts/conversion_chart_mesh_inches_microns_millimeters.htm)**Additional Notes**

In strongly oxidized, calcareous ore samples with a high organic content, smaller particles may be cemented or aggregated together. In these cases, a pretreatment will be required prior to sieving, at least for the soil and gravel fractions, to remove the cement (Kroetsch and Wang, 2008). However, it should be noted that chemical and/or physical pretreatment may alter the original sample by dissolution or destruction of some minerals.

*In strongly oxidized, calcareous ore samples with a high organic content, smaller particles may be cemented or aggregated together.*

The weight of sieved material depends on various factors including the particle size distribution and the width of the sieves. Screen blinding may occur with 500 g of some samples. Additional sieves may be added to avoid having excess material on the finer screens. Large coarse fragments, which are logistically difficult to handle, are typically omitted from the measurement of particle size distribution.

### 16.3 A More Refined Particle Size Separation for Surface Area Determinations

1. Ensure that all screens to be used for the test work are clean and made of stainless steel.
2. Prior to starting separation, record the total weight of the sample and each of the screens.
3. Wet screen the sample on a Tyler 250 mesh screen ( $< 63 \mu\text{m}$ ). If the sample is coarse, pass it through larger size screens first and report their screen or mesh sizes. Retain the grains passing through this fine screen for possible later sizing using an alternative method for silts and clays.
4. Filter and dry the two screen fractions. Flocculating the -250 mesh fraction will enhance the filtering. Note: Drying, especially above  $40^{\circ}\text{C}$ , can change the mineralogy.
5. Weigh and record the dry weight of the sands (+250 mesh) and silts and clay (-250 mesh) material.
6. Weigh and record the weight of each screen then assemble the nest of screens required for the test. The mesh size and number of screens will depend on the weight and coarseness of the sample. For example, a screen nest may start with the largest screen at 6 mesh or 8 mesh and the smallest screen at 250 mesh, with up to 10 or 12 screens in between. In addition to the sample size, weight and coarseness, the number of screens used will be determined by the type of shaking apparatus available (i.e. how large a screen nest will fit on the screening device).
7. Pour the sample onto the top screen and secure the lid. The sample size will be determined by the size of the sieve apparatus and the amount of the available sample/sub-sample.
8. Place the nest of screens onto the shaker and secure them to the machine. If some grains agglomerate (clump), add water periodically or continuously.
9. Set the timer to 20 minutes duration and turn on the machine.
10. At the end of the 20 minutes remove the screens. Weigh each of the screens and record the weights.
11. Subtract the original weight of that screen from the weight of each screen plus sample fraction (dry). Record each fraction weight on the screen analysis report. Particle size analyses are reported in tabular or graphical form.
12. Where assays or other analyses are required, each fraction should be prepared as needed. If no assays or analyses are required, the fractions can be recombined and stored as one sample or stored separately.

### 16.4 Calculation or Measurement of Particle Surface Area

Surface area of the less than small stone size particles can be measured from gas absorption techniques such as BET or visually using a SEM. More refined particle size separation can be used to calculate geometric surface areas for the entire sample based on the assumption that the surface area of each particle is proportional to its width as a cube or diameter as a sphere. Equations for calculating geometric surface area are found in textbooks addressing particle size

area or as free software such as Grain 3.0 (<http://www.mdag.com/grain30.html>) that provides automatic calculations upon entry of sieve data. Surface area dependent reaction rates for kinetic tests can then be calculated and scaled to fit other particle sizes. The normalization of rates to geometric surface areas can lessen the discrepancies among different sized kinetic tests (Day, 1994).

It should be noted that the use of geometric surface areas for calculation of surface area rates is prone to significant errors (Morin and Hutt, 1997). Since mineral grains are rarely cubes or spheres and do not necessarily have smooth surfaces and regular shapes, the actual surface area may be much higher than the calculated geometric surface area. Other, more direct methods such as nitrogen-adsorption BET, which is also prone to some errors, have shown that surface areas can be 100-1000 times higher than the geometric value, especially with the precipitation of secondary minerals onto primary minerals.

## 16.5 References

- Allen, T. 1981. Particle Size Measurement. 3rd Edition. Chapman and Hall, New York.
- Birkeland, P.W. 1974. Pedology, Weathering and Geomorphological Research. Oxford University Press. p. 285.
- Day, S. 1994. Long Term Acid Generation Studies: Cinola Project British Columbia. MEND Report 1.19.1.
- Kroetsch, D. and C. Wang. 2008. Chapter 55: Particle Size Distribution. In: M.R. Carter and E.G. Gregorich (eds.) Soil Sampling and Methods of Analysis (2nd ed.). Canadian Society of Soil Science / CRC Press. pp. 713-725.
- Morin, K.A. and N.M. Hutt. 1997. Environmental Geochemistry of Minesite Drainage: Practical Theory and Case Studies. MDAG Publishing. p. 333.

## 17.0 MINERALOGICAL PROPERTIES

### *Some Important Points in this Chapter*

*Mineralogical analyses measure properties of individual mineral phases and their contributions to geologic materials as a whole. Mineralogical information is an essential component of drainage chemistry prediction because mineralogical properties determine the physical and geochemical stability and relative weathering rates of geological materials under different weathering conditions. This is important for the selection, design, check of assumptions and interpretation of the results of other static and kinetic tests.*

*The mineralogical methods discussed in this chapter are: visual descriptions; petrographic analysis; X-ray Diffraction (XRD), preferably by the Rietveld Method; Scanning Electron Microscopy coupled with Energy Dispersive X-ray Spectroscopy (SEM/EDS); Electron Microprobe; laser ablation and other microbeam analyses; image analysis; and calculated mineralogy from solid phase elemental data. Each method has strengths and weaknesses. As a minimum, prediction programs generally should include visual descriptions, petrographic analysis and X-ray Diffraction analyses.*

### 17.1 Introduction

Mineralogical analyses measure properties of individual mineral phases and the contribution of each mineral phases to geologic materials as a whole. Mineral phases include crystalline minerals and amorphous material. Mineralogical information is an essential component of drainage chemistry prediction because mineralogical properties determine the physical and geochemical stability and relative weathering rates of geologic materials under different weathering conditions. Mineralogical properties also determine the concentration of potentially harmful, acid generating or acid neutralizing chemical species (Alpers et al., 2004; Thompson et al., 2005; Kwong and Ferguson, 1990).

*Mineralogical information is an essential component of drainage chemistry prediction.*

Important mineralogical information in drainage chemistry prediction typically includes:

- mineral sources of elements that are potentially harmful at high aqueous concentrations, including soluble mineral phases (Chapter 11);
- sulphide and sulphate minerals and other sulphur species and potential sources of acidity (Chapter 12);
- carbonate and aluminosilicate minerals and other potential sources of acid neutralization (Chapter 13), including mineral phases which contribute to laboratory measurements of acid neutralization but may not provide similar contributions in the field (e.g. siderite and ankerite);

- potential for reactive minerals (e.g. carbonates and sulphides) to preferentially occur in the finer particle size fraction, where they can contribute to drainage chemistry, as opposed to larger particles, where they would be encapsulated and inert (Chapters 8 and 16); and
- physical properties that will influence present and future rates of mineral weathering (Chapters 6 and 7).

The mineral phases and mineralogical properties influencing drainage chemistry and drainage chemistry prediction will depend on the mineralogy, materials handling, weathering conditions and the questions raised by other test work.

Mineralogical assessment encompasses a wide range of information requirements beyond the already challenging task of identifying and determining the relative mass or volume of different minerals. Properties of mineral phases potentially influencing weathering include:

*Mineralogical assessment encompasses a wide range of information requirements beyond the already challenging task of identifying and determining the relative mass or volume of different minerals.*

- identity;
- mode of formation;
- abundance;
- major element composition;
- concentration of elements occurring as impurities;
- size, frequency and chemistry of inclusions;
- size, frequency and chemistry of surface layers and coatings precipitated from the products of the previous weathering;
- grain size distribution;
- spatial distribution;
- mineral associations;
- exposed surface area; and
- crystal shapes and surface deformities.

Identification of mineral phases, including primary and secondary minerals and amorphous flocs and surface coatings, is needed to predict relative weathering rates under different weathering conditions. Measurement of mineral abundance (quantitative phase analysis) is needed to predict the total contribution of different mineral phases under different weathering conditions. The most common techniques to acquire mineral abundance data are petrographic point counting and Rietveld analysis of powder X-ray Diffraction (XRD) data and image analysis.

Mineral identity will, to a varying degree, indicate the concentration of elements that are a major part of the mineral composition. Measurement of crystal structural differences (e.g. by XRD) or the concentration of major chemical elements (e.g. by SEM or electron microprobe analysis) may be required to determine the concentration of potentially harmful, acid generating and acid neutralizing chemical elements in minerals that are part of a solid solution, such as dolomite ankerite series.



Not all of the elements are a major part of the mineral composition. Measurement is also required of the abundance and chemical composition of:

- minor or trace impurities or inclusions of mineral phases;
- weathered surface layers of mineral phases; and
- amorphous surface coatings or flocs.

Minor or trace impurities or inclusions in iron sulphide and sulphate minerals may be a major source of potentially harmful chemical species (Chapters 5, 11 and 12). Also, weathered surface layers and amorphous surface coatings or flocs may result in significant adsorption and co-precipitation of potentially harmful chemical species.

The rate of weathering and elemental release depends not only on the chemical composition, but also on the physical properties of minerals. Physical properties such as crystal deformities and a larger exposed mineral surface area will increase the rate of weathering. A smaller grain size may increase crystal deformities and the exposed mineral surface area per unit weight.

*The rate of weathering and element release depends not only on the chemical composition, but also on the physical properties of minerals.*

The spatial distribution of minerals, including the association with mechanically weaker minerals and structural features, may increase the exposed mineral surface area per unit weight when the bedrock is excavated. Mineral grains in, or adjacent to, veins and fractures and areas containing clay minerals that lack cohesion will preferentially report to surfaces and finer particles when bedrock is excavated. Mineral grains occurring in areas of strong, cohesive bedrock that preferentially reports to coarser fragments may remain relatively occluded and unweathered.

There may be differences in the composition between the stronger and weaker zones within bedrock. Stronger and weaker zones will likely disproportionately report to coarse and fine particles in waste rock, respectively. This may result in differences between the composition and corresponding predicted behaviour of the whole rock measured in the analysis of drill core and behavior of waste rock, which is likely to depend primarily on the composition of only the finer particles.

### **17.1.1 Use in Selection, Design and Interpretation of Other Analyses and Tests**

One of the most important uses of mineralogical analysis is in the selection, design, check of assumptions, and interpretation of the results of other static and kinetic tests (e.g. Chapters 12, 13 and 18).

The following is a list of examples of the use of mineralogical information in the selection and design of static geochemical analyses and kinetic tests.

- Mineral identity and concentration will indicate which minerals are likely to contribute to static test measurements, such as acid generating potential and acid neutralization potential, and the likelihood that they will contribute similar amounts in the field to the analytical results.

- The identity and concentration of potentially soluble mineral phases should be considered when selecting the leachate, the ratio of water to solid and other aspects of the analysis of soluble constituents.
- The mineral source for problematic weathering products, such as those that contain elements that are potentially harmful at high aqueous concentrations, may be needed to identify which weathering conditions will result in their release and should be included in kinetic tests designed to predict potential release rates.
- The concentration of contributing mineral phases in the test material before kinetic testing should be considered when selecting the ratio of water to solid and how long kinetic tests should be run to provide the required information necessary to evaluate likely sources for solutes measured in the leachate.
- The mineralogy of the test material after kinetic testing will provide a check on dissolution rates calculated from solutes measured in the leachate, and will indicate likely sources of solutes measured in the final leachate and if some weathering products were not removed.
- The spatial distribution of minerals should be considered when deciding on the sample location and size, methods of sample preparation, and the size fractions to analyze or test.
- The extent of previous weathering should be considered when selecting methods of sample preparation and in the interpretation of test results.

Static analyses and kinetic tests, such as the analyses of different sulphur species and forms of acid neutralizing potential, soluble constituent analysis and humidity cell tests, are not mineral specific. Information regarding the identity of minerals potentially contributing to the measured properties is required in the interpretation of their results. Mineralogical analyses that check assumptions regarding the contributing minerals are also needed to ensure that static tests and the subsequent calculations are conducted correctly.

The assumption that analytical results come from the most commonly found minerals is correct for some samples. However, this is not always the case. Major errors in the predicted drainage chemistry may result if significant deviations from the assumed mineralogy are not recognized.

The following are examples of how mineralogical information is used to interpret results of static tests, kinetic tests, field monitoring of drainage chemistry and other aspects of prediction.

- Petrographic and XRD analyses identify sulphide and sulphate minerals, as well as other sulphur species and potential sources of acidity.
- Electron microprobe analysis of the chemical composition of minerals will indicate the percentage of whole-rock or near-total trace element concentrations that occurs as sulphide and sulphate minerals. The composition of sulphide and sulphate minerals is used to predict which will generate the same amount of acidity as pyrite.
- SEM/EDS or electron microprobe analysis of the chemical composition of different minerals may be needed to identify mineral sources of potentially harmful elements.
- Electron microprobe analysis of the chemical composition of different minerals may be needed to check the assumption that all whole-rock or near-total elemental concentrations of Ba and Pb occur as acid insoluble sulphates. This information is used in the calculation of sulphide-S and acid potential (AP).

- XRD analysis of the mineral concentration and possibly electron microprobe analysis of the chemical composition of different carbonate minerals may be needed to estimate the proportion of carbonate-C that occurs as iron and manganese carbonates, and is thus not net neutralizing under aerobic conditions.
- Petrographic and XRD analyses are needed to identify potentially significant aluminosilicate acid neutralization sources at a near-neutral pH and any mineral phases which contribute to laboratory measurements of acid neutralization but may not provide similar contributions in the field (e.g. siderite and ankerite).
- Petrographic analysis of the relative distribution of acid generating and acid neutralizing minerals in fractures and veins versus that in the ground mass is important prior to mining to predict whether waste rock fines will have a different composition from the whole rock.
- Petrographic analysis of mineral associations is needed to check the potential for galvanic effects that may impact the sequence and timing of metal leaching or acid generation.

It is important to recognize that the use of mineralogical analysis in the selection and design of static and kinetic tests and interpretation of their results, can only happen if the mineralogical analysis is completed prior to these activities.

### 17.1.2 Limitations

Mineralogical analysis techniques differ in their capabilities, speed, accuracy and the mineral phases and grain sizes they can identify. Each technique has different weaknesses. Limitations of mineralogical analysis may result in an incomplete understanding of the contribution of different minerals to static analysis and kinetic test results or field weathering and drainage chemistry. Comprehensive, accurate and precise mineralogical information may be difficult to obtain. Some of the challenges associated with mineralogical analysis include the following:

*Mineralogical analysis techniques differ in their capabilities, speed, accuracy and the mineral phases and grain sizes they can identify.*

- many mineralogical analyses can only provide qualitative or semi-quantitative information, have relatively high detection limits and/or make measurements over a limited volume;
- minerals may deviate from the theoretical chemical formula (e.g. Fe-Mg substitution in the dolomite ankerite series);
- many minerals are solid solutions that vary significantly in their composition, weatherability and other properties which significantly impact their contribution to drainage chemistry. For example, the mineral “plagioclase” ranges in composition from the relatively rapid weathering calcic plagioclase to the much slower weathering sodic plagioclase. Detailed analysis of the chemical composition of solid solution minerals may be needed to determine key aspects of their performance;
- a significant proportion of the concentration of potentially important minor and trace elements may exist as impurities rather than major structural elements and detailed chemical analysis of mineral composition is needed to identify potential mineral sources; and
- important minerals such as calcite may occur in trace amounts making it difficult to detect them, and to measure their concentration and chemical composition.

### 17.1.3 Overview of Methods

Mineralogical analysis techniques differ in sample preparation, properties measured, accuracy and precision of assessment and detection limits. The most commonly used mineralogical analysis procedures are the following:

- visual description;
- petrographic analysis;
- X-ray Diffraction (XRD);
- Scanning Electron Microscopy with Energy Dispersive Spectrophotometer (SEM/EDS);
- electron microprobe;
- laser ablation and other microbeam techniques;
- image analysis; and
- calculated mineralogy from solid phase elemental data.

Mineral quantities may be determined by the Rietveld analysis of powder XRD data or point counting and image analysis during petrographic, SEM/EDS and electron microprobe analysis.

More specialized mineralogical techniques capable of providing extremely low detection limits, analysis of small depths or areas and/or information on different oxidation states, types of bonding and adsorption modes include: laser ablation ICPMS, proton induced X-ray emission (PIXE), secondary ion mass spectrometry (SIMS), X-ray Absorption Spectroscopy (EXAFS, XANES) and Micro-XRD (Flemming et al., 2005; Walker et. al., 2005).

## 17.2 Visual Description

Visual examination of sulphidic geologic material provides valuable mineralogical information and would be an important part of any prediction program. Visual properties may also be important in material management and mitigation. Visual descriptions should be made with the aid of a hand lens. Minerals may be identified from visual properties such as crystal habit, cleavage, fracture, luster, colour and simple field procedures, such as scratch tests for streak and mineral hardness and the hydrochloric fizz test for carbonate minerals. In addition to mineral identification, a visual description will provide information on mineral association, distribution, grain size, hydrothermal alteration and weathering features. A list of suggested information requirements is provided in Section 6.6.4.

Visual descriptions can provide information about large scale geological variability, structural features, such as fractures and veins, and mineral associations with other minerals and different geologic units. The information from large scale visual assessments will aid in the interpretation of mineralogical results from smaller scale measurements made on samples taken over short intervals and their application to project components, structural features and geological units as a whole.



**Figure 17.1 Visual descriptions of drill core provide valuable mineralogical information.**

Prior to excavation, visual mineralogical descriptions can be made of geologic materials exposed in rock outcrops, excavations in non-lithified materials, exploration adits, bulk samples and drill core (Figure 17.1). During mining, visual mineralogical descriptions for drainage chemistry prediction should be made as part of the geological descriptions by field geologists when sampling and logging blast hole drill chips. Where this information is lacking, visual mineralogical descriptions may be made as part of the geological mapping of underground mine workings, pits, mine wastes and other mine components at, or after, the mine closes.

Visual descriptions of weathered materials may provide valuable information on the mineral

*Visual descriptions of weathered materials may provide valuable information on the mineral exposure, weathering conditions, mineral reaction rates, relative mineral reactivity and secondary mineral formation under field conditions.*

exposure, weathering conditions, mineral reaction rates, relative mineral reactivity and secondary mineral formation under field conditions. Visual descriptions of weathered materials can also guide sampling for other mineralogical procedures.

Information on mineral exposure and weathering conditions will be important in the interpretation of results and their extrapolation to other geologic materials and project components. An important observation with regards to mineral weathering is whether secondary minerals have formed from the products of in-situ weathering or external weathering products transported by inflowing drainage.

Where possible, the examination of weathering features should include a measurement of rinse pH and colour changes (Section 8.10 and Chapter 11). The browning of carbonate minerals in the drill core in Figure 17.1 results from the oxidation of ferrous iron in carbonate minerals.

Criteria used for mineral identification and differentiation should be identified. Users of visual mineralogical descriptions should be aware of the limitations in mineral identification and the tendency for visual descriptions to include educated guesses, which may not be identified as such.

While it can provide a good start, the mineralogical information resulting from a visual assessment will not be sufficiently accurate for many aspects of drainage chemistry prediction. Mineral identification is often limited to large grains and the accuracy of identification depends in part on the practitioner and their experience and familiarity with the geology of the area. Weathering and other forms of alteration make correct mineral identification more difficult.

### 17.3 Petrographic Microscope

A petrographic or polarizing microscope allows identification of mineral phases and observation

*A petrographic or polarizing microscope allows identification of mineral phases and observation of the size, condition and arrangement of mineral grains.*

of the size, condition and arrangement of mineral grains, making this technique a valuable prediction tool. Petrographic microscopes use plane-polarized light to measure optical properties of minerals in polished thin sections. Light can be transmitted through thin sections of most minerals.

Reflected polarized light may be used to identify mineral phases that are opaque even in thin section and cannot be analyzed using transmitted light. Most sulphide minerals are opaque. Other opaque minerals include graphite, hematite and magnetite.

The information provided by petrographic analysis is useful for interpreting the results of other more destructive forms of chemical and mineralogical analysis. Measurement of mineral abundance by petrographic analysis provides a valuable check on visual and XRD results (Thompson et al., 2005). Jambor and Blowes (1998) suggested conducting SEM/EDS on polished thin sections, in addition to petrographic descriptions based on transmitted light and reflected light microscopy.

#### 17.3.1 Objectives

Reflected and transmitted light microscopy on thin sections can be used to:

- identify and measure the abundance of crystalline mineral phases;
- identify the presence of amorphous flocs and coatings;



- measure the grain size, shape, exposed surface area, crystal shapes, weathering features and surface deformities of different mineral phases; and
- measure the spatial distribution and associations of different mineral phases.

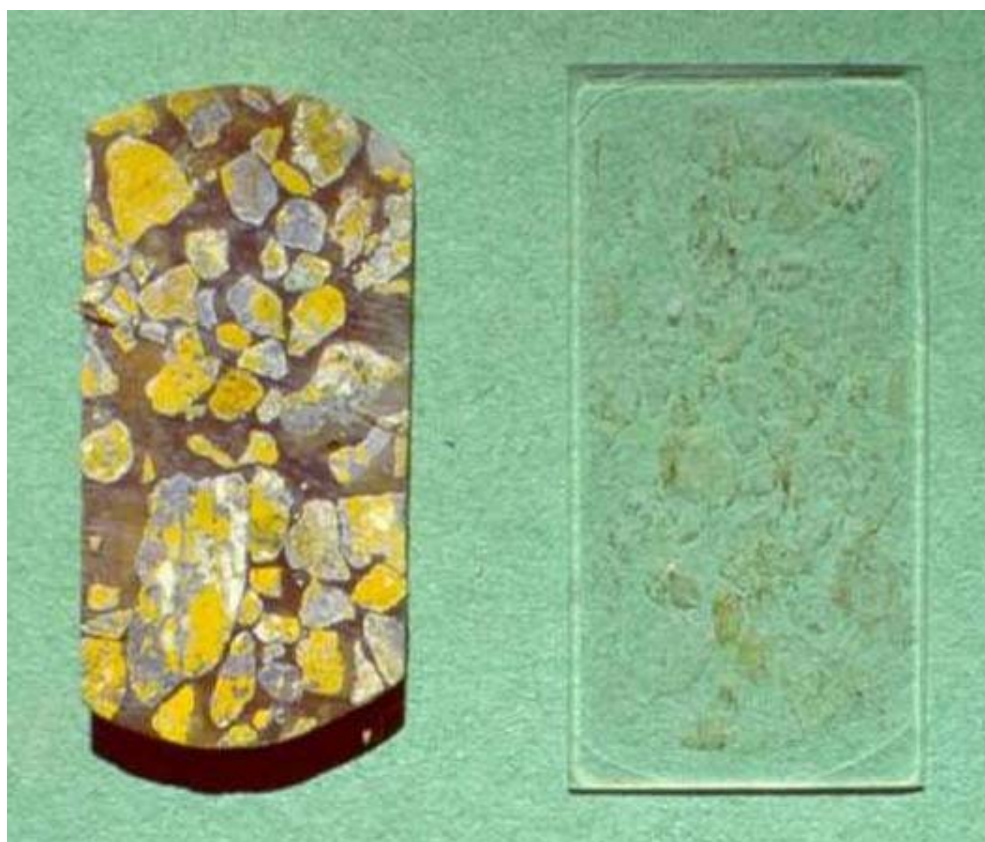
Preservation of individual grains and their spatial distribution and the larger field of vision than sub-microscopic techniques makes petrographic analysis particularly useful for identifying:

- alteration and weathering features, such as weathering rims and oxidation of sulphides;
- association of different minerals; and
- relative percentages of different minerals in, or adjacent to, areas of weakness, such as fractures and veins.

The relatively small grain size detection limit makes petrographic analysis especially useful for the detection of sulphide minerals.

### 17.3.2 Sample Preparation

A thin section consists of a thinly ground, translucent slice of material mounted on a 46 mm x 26 mm glass slide (Figure 17.2). Thin sections may be created from rock, chip and pulverized samples. Pulverized samples may provide some information on mineralogy, but due to problems identifying very small grains, this type of sample is the least helpful in petrography.



**Figure 17.2** A petrographic thin section cut from particles embedded in resin and stained with sodium cobaltinitrate to identify potassium feldspar.

Thin sections should be 30  $\mu\text{m}$  thick. Polished thin sections are recommended because in addition to observation under transmitted light, they can also be used for the identification of opaque minerals under reflected light and for SEM/EDS analysis.

Friable and fragile materials, such as secondary minerals, clays and other alteration and weathering products, require impregnation with resins prior to sectioning. The choice of resins will depend on the materials. For example, polyester resins are the most suitable for impregnating clay rich material, but they react with sulphate minerals and are unsuitable for use with ocean floor materials.

Wet or damp samples must be dried at low temperatures prior to impregnation. Drying should not occur at high temperatures because clay rich materials and certain sulphates (e.g. gypsum and anhydrite) react adversely to heat and water.

Other potential concerns are that loose grinding powder can become embedded in resin or soft clay rich material and that polishing techniques, such as the use of metal laps, can cause plucking, surface deformation and cracking of minerals.

### 17.3.3 Mineralogical Analysis

Mineral identification occurs through familiarity with diagnostic characteristic features and a process of elimination (Figure 17.3). Diagnostic optical properties of light transmitted through mineral thin sections that are used to identify mineral phases include: colour, birefringence, pleochroism, relative relief, crystal shape, cleavage, twinning and whether the mineral is isotropic or anisotropic (Hurlbut and Klein, 1985).

Opaque minerals may be distinguished under reflected light by their characteristic colours and crystal shape.

The use of stains that are calcium or potassium specific, after first etching the slide with hydrofluoric acid (HF), may be used to distinguish some calcic and potassium feldspar minerals. Staining with sodium cobaltinitrate is used to identify potassium feldspar (Figure 17.2). Staining with sodium barium chloride and potassium rhodizonate is used to identify calcium bearing plagioclase.

Measurement of mineral abundance by petrographic analysis can be done with either a general visual scan or more time consuming point counting procedures. A general scan of the slide can be relatively quick (30 minutes) and will provide useful information on the major and minor mineral phases, their shapes, grain size, spatial relationships and an estimate of their relative proportions. Point counting provides a more accurate and less subjective estimate of mineral percentages.

*Measurement of mineral abundance by petrographic analysis can be done with either a general visual scan or more time consuming point counting procedures.*

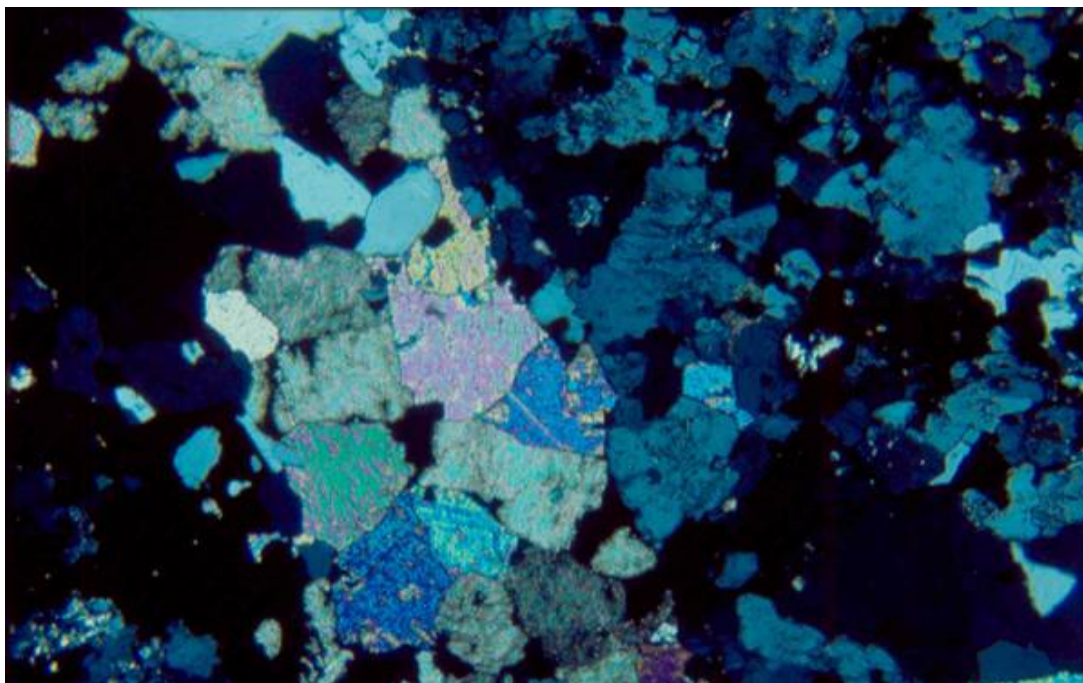
It is important that the reporting of petrographic analysis results note:

- size limitations in the identification of mineral grains;
- unidentified parts of the material;

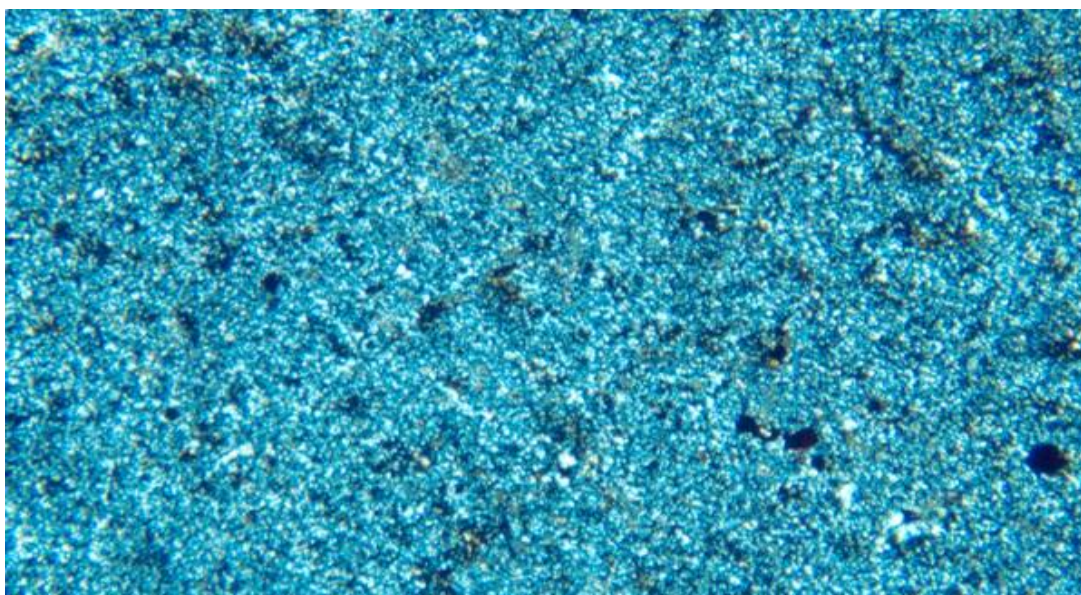


- limitations in the accuracy of mineral identification and estimates of mineral abundance and grain size; and
- potential losses of material during sectioning.

Other mineralogical techniques, such as SEM, Rietveld analysis of XRD data or other more specialized techniques are needed to confirm results and measure additional properties.



**Figure 17.3** A petrographic slide showing calcite grains (light coloured) in a fracture and feldspar and quartz (darker) grains in the surrounding groundmass.



**Figure 17.4** The mineral phase of grains less than 20 µm in diameter in this hornfels petrographic sample are difficult to identify.

### 17.3.4 Limitations

The dimensions of rock contained in a thin section are relatively small compared to the dimensions of other samples. Results from a single thin section will only apply to a relatively small volume of rock and are unlikely to be representative of the material as a whole. Therefore, a large number of thin sections would be required to accurately characterize heterogeneous materials.

Minerals present in amounts less than roughly 0.2-0.5 volume % will not normally be detected. Also, the minimum grain size for the detection of different minerals will depend on the quality of the microscope. Thus, petrographic analysis is unable to identify the mineral form of small silicate grains less than approximately 20  $\mu\text{m}$  (e.g. tailings slimes, Figure 17.4) and fracture coatings. Exceptions include sulphide minerals, which may be detectable as small as 5-10  $\mu\text{m}$ .

Petrographic analyses are limited in their ability to determine the site specific elemental composition of minerals that exist as solid solutions and whose composition can vary significantly. Therefore, petrographic methods cannot easily distinguish between some carbonate species. The best practice approach for identifying carbonate species and determining their chemical composition would include

*Petrographic analyses are limited in their ability to determine the site specific elemental composition of minerals that exist as solid solutions and whose composition can vary significantly.*

Rietveld analysis of XRD data, coupled with SEM/EDS or electron microprobe analysis.

Petrographic analysis may be unable to detect incipient hydrothermal alteration or weathering of primary minerals, which could lead to erroneous predictions of mineral quantities. An example is the hydrothermal alteration of plagioclase to calcite, which if underestimated will lead to an under estimation of the acid neutralization in a test sample.

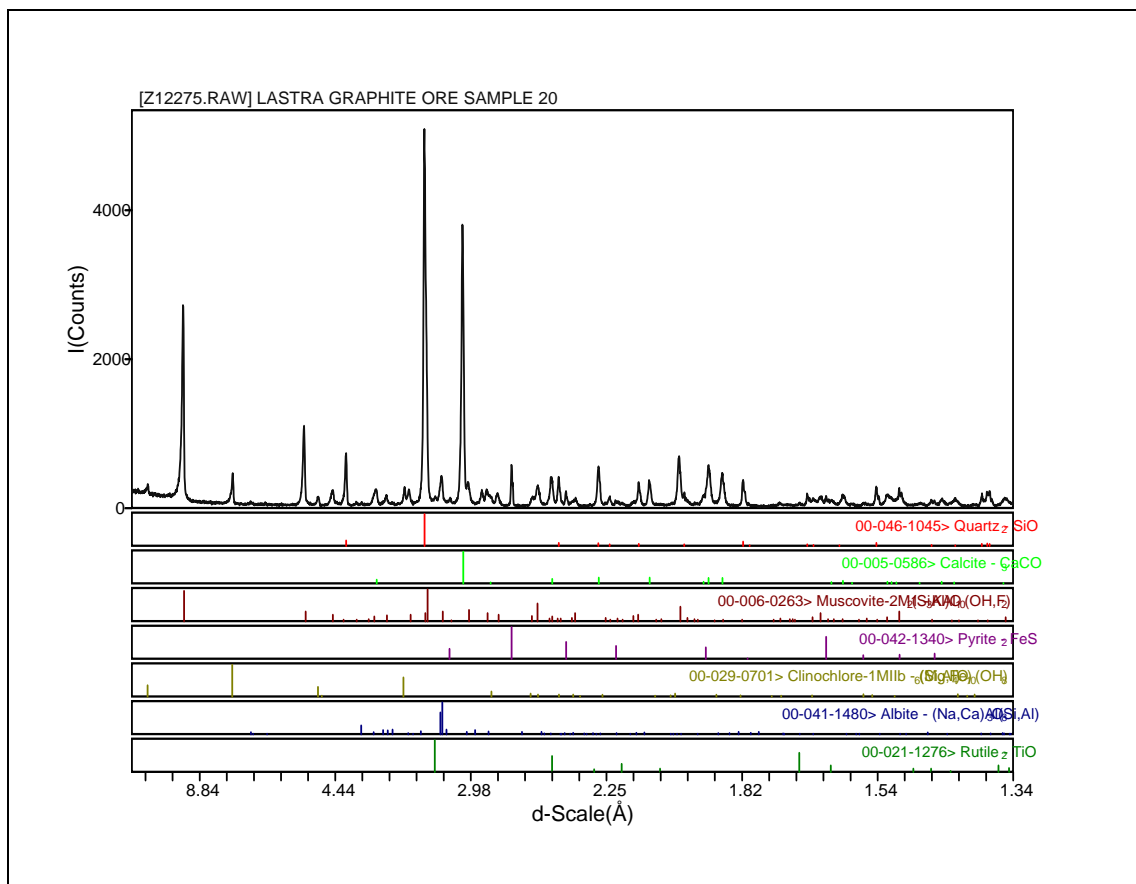
Quantitative analysis of mineral abundance is labour intensive and very time consuming and limited by the minimum grain size for the detection of different minerals. Given the potential limitations in mineral identification with petrographic analysis and the lack of automated procedures, in some cases point counting is better carried out using sub-microscopic techniques such as SEM/EDX and electron microprobe analysis.

Like other forms of mineralogical techniques, petrographic analysis is dependent on the skill of the operator. Care should be taken to base mineral identification on the optical evidence and not speculation about the expected composition or theories of mineral and rock formation.

## 17.4 X-ray Diffraction

X-ray Diffraction (XRD) is one of the most cost-effective procedures for the identification of different mineral phases and the semi-quantitative or quantitative (the Rietveld XRD method) estimation of mineral abundance.

X-ray Diffraction is not limited by grain size and is able to distinguish minerals with a similar chemical composition, such as pyrite and marcasite. XRD may be capable of measuring mineral phases that exist as intergrowth or altered phases that cannot be detected visually or by petrographic analysis.



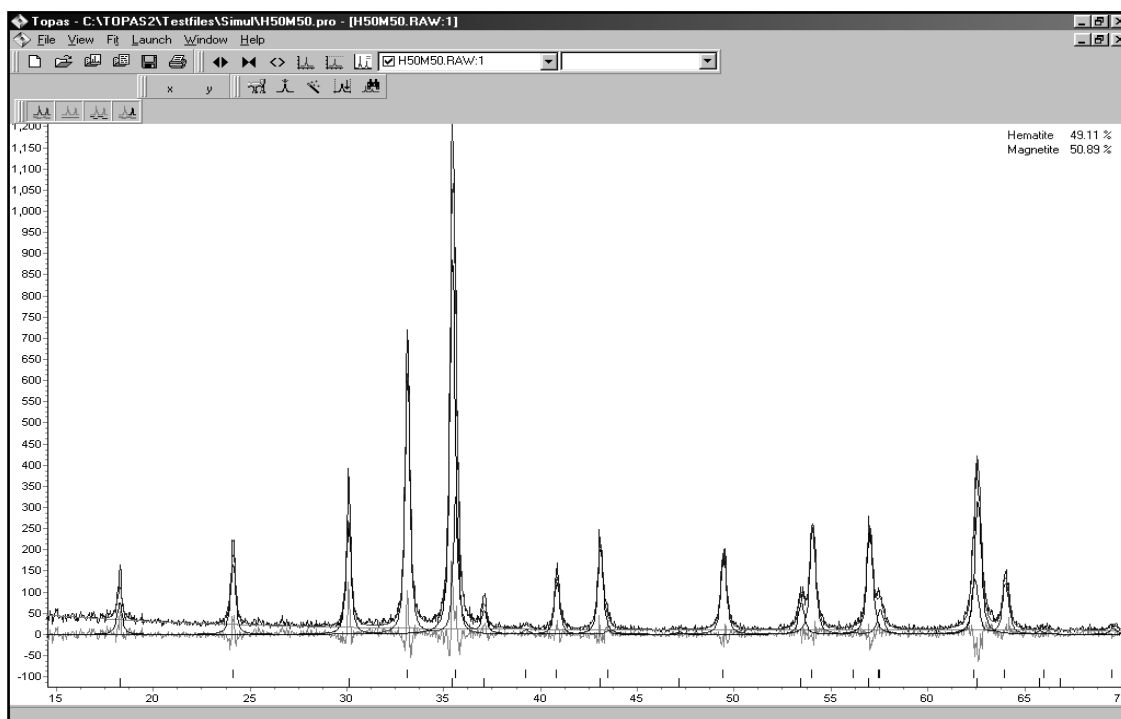
**Figure 17.5** An XRD pattern of a sample containing quartz, calcite, muscovite, pyrite, clinocllore and rutile.

#### 17.4.1 General Methodology for XRD

XRD is conducted on single crystals or more commonly with rock samples prepared for analysis by crushing and grinding to a powder. The powdered sample is randomly packed into a cavity in a holder. Powdered samples may also be smeared wet onto a glass slide for quick analysis. In both cases, a flat surface faces the X-ray beam.

Mineral phases are identified by comparison of the locations and intensities of the diffraction peak with those of mineral reference standards in a database such as the International Center for Diffraction Data (ICDD) PDF-4+ database.

Detection levels of mineral constituents may be as low as a few tenths of a percent using modern high speed detectors if the peaks of the phase of interest are not overlapped by peaks of other phases.



**Figure 17.6 Fitting the calculated diffraction pattern to the observed XRD pattern for a 1:1 mixture of hematite and magnetite (Raudsepp and Pani, 2001).**

#### 17.4.2 Rietveld Analysis of Powder XRD Data

Rietveld analysis of XRD data from a powder sample measures the concentration of all mineral phases. The low detection limits and quantitative nature of the data is of great benefit for drainage chemistry assessment and this procedure is highly recommended (Raudsepp and Pani, 2001 and 2003).

*The Rietveld analysis of powder XRD data is highly recommended.*

Rietveld analysis generates calculated diffraction patterns for each phase in a mixture and scales them to the whole observed powder diffraction pattern (Figure 17.6). Structural parameters of each mineral, such as atomic coordinates, site occupancies and displacement parameters and experimental parameters, such as peak shape and background, of the calculated diffraction data are refined using least squares procedures to minimize differences between the observed and calculated diffraction patterns.

The Rietveld method is described in Raudsepp and Pani (2003). The method requires that the sample be ground under alcohol to an average particle size of  $< 5 \mu\text{m}$ . Alcohol minimizes heat production during grinding, protects the crystal structures of delicate minerals such as micas from damage and disperses the sample, thereby preventing clumping. A particle size of  $< 5 \mu\text{m}$  minimizes micro-absorption and preferred orientation and improves the reproducibility of the diffraction pattern. Preferred orientation can be further minimized by gently back-pressing the powder against a ground glass slide in a standard aluminum holder. A long sample holder (e.g. 43 mm) will ensure the irradiated area is completely within the sample.

Strengths of the Rietveld analysis include:

- peaks are easily modeled and refined; and
- cell dimensions can be used to distinguish between different phases of minerals that exist as solid solutions, and to estimate the elemental content (e.g. Fe + Mn content in the dolomite ankerite series).

These features of Rietveld analysis allow quantitative measurement of the abundance of different minerals (Table 17.1). Despite much overlapping of carbonate peaks, these features allow quantitative measurement of co-existing carbonate phases, such as calcite, siderite and ankerite, even at low concentrations.

**Table 17.1 An example of Rietveld analysis results for rock samples containing a number of different carbonate minerals (from the Kemess mine).**

Sample	Calcite	Sid	Ank	Qtz	Alb	Ortho	Kao	Chl	Musc	Py	Ill	Hem	Bar	Total
B23381	0.3	5.9	7.1	42.8	5.9		32.0		5.2	1.0				100
B23820	1.1	5.5	4.3	72.8			4.9		1.7	0.8				100
C17317		5.3	6.0	72.9	1.0		11.9		2.0			0.5	0.5	100
B23224	7.2	4.5	1.5	63.8			16.4		5.4	0.8			0.5	100
B23373	5.3	0.7		37.4	18.3	3.4	3.3	18.1	11.5	1.1	1.0			100
C14822	4.7	0.5		44.4	15.8	5.3		29.3						100
C17310	0.4		9.6	68.6			12.0		7.0	2.1			0.3	100
C17214	5.2		2.9	79.8			5.4		4.9	1.4			0.5	100
C17295	1.2			8.3	1.1	3.5		3.6		1.3				100
B23125	9.6			57.1		2.7	1.8	14.1	12.7	2.0				100
B23934	8.2			54.4	3.6	2.2	1.3	11.5	15.0	1.2	2.6			100
B23883	7.0			8.1				4.3	5.3	2.1			1.2	100

Minerals abbreviated: Sid (Siderite), Ank (Ankerite), Qtz (Quartz), Alb (Albite), Ortho (Orthoclase), Kao (Kaolinite), Chl (Chlorite/Clinocllore), Musc (Muscovite), Py (Pyrite), Ill (Illite), Hem (Hematite) and Bar (Barite)

### 17.4.3 Limitations

Detection limits for mineral abundances measured with the Rietveld method depend on the:

- XRD instrument, particularly detector sensitivity;
- counting time per point and the frequency of analyzed points; and
- composition of material, particularly the degree of peak overlap.

Small errors may occur in statistically fitting peaks, overlapping peaks and from differences in micro-absorption of minerals.

Detection limits for different mineral phases using the Rietveld method may be as low as 0.1 to

*One potentially important overlap of XRD peaks in sulphidic geologic materials is that of the main peaks of chalcopyrite and calcite.*

0.2 wt% if there are no overlaps from peaks of other mineral phases. For example, small amounts of biotite may not be detected in XRD analyses because of overlapping peaks

of illite/muscovite. One potentially important overlap in sulphidic geologic materials is that of the main peaks of chalcopyrite and calcite.

Mineral identification is more difficult and estimation of mineral abundance is at best semi-quantitative for disordered minerals such as hydrated sulphates and disordered secondary phyllosilicate clay minerals, such as smectite and kaolinite. Phyllosilicate clay mineral species can be identified by the different changes to the interlayer spacing caused by K, Mg, heating and glycol pretreatments (Whittig, 1965). In addition, powder XRD is limited in its ability to determine the composition of minerals which are solid solutions.

Optical microscopy (Section 17.3) and bulk chemical analysis (Chapter 10) are recommended in addition to XRD to verify mineral identification and quantification and to provide information on the spatial distribution of different mineral phases within particles or geological strata. XRD is limited in its ability to determine the composition of solid solution minerals. Quantitative elemental compositions of solid solution minerals are best measured using electron microprobe analysis of a polished section.

Like other mineralogical techniques, XRD analysis is dependent on the skill and knowledge of

*Like other forms of mineralogical analysis, XRD analysis is dependent on the skill and knowledge of the operator.*

the operator. A major limitation of the Rietveld method is that the number of facilities presently

conducting Rietveld analysis are limited to a few universities (e.g. University of British Columbia, Department of Earth and Ocean Sciences), government agencies (e.g. CANMET-MMSL) and major mining companies (e.g. Teck and Phelps Dodge).

Conventional XRD is unable to detect amorphous mineral phases that lack regularly spaced planes of atoms, such as oxyhydroxides of iron, aluminum and aluminosilicates, which are commonly associated with the drainage from sulphidic geologic materials. The amount of amorphous material present can be determined using the Rietveld method by spiking samples with a known amount of a crystalline phase not present in a sample (Raudsepp and Pani, 2003). SEM/EDS (Section 17.5), electron microprobe (Section 17.6), laser ablation (Section 17.7) or selective dissolution procedures developed for use on soil samples (Pansu and Gautheyrou, 2006) can be used to determine the composition of amorphous mineral phases.

### 17.5 Scanning Electron Microscope and Energy Dispersive X-ray Spectrometer

A Scanning Electron Microscope (SEM) is used to identify minerals, to determine their grain size and arrangement of mineral grains, and to estimate their elemental composition.

Irradiation of the sample by an electron beam produces backscattered electrons, secondary electrons and characteristic X-rays. Analysis may be conducted on raw particles or polished sections created from sections of rock and polished thin sections of rock or particles mounted in polished resin blocks (Section 17.3). The sample needs to be coated with a thin conductive layer of carbon or gold for analysis in conventional high vacuum SEM. Coatings are not required for low vacuum SEM.

Minerals may be rapidly distinguished from the image produced from backscattered electrons by their shade of gray, which depends on their average atomic number. Silicate minerals have a lower average atomic number and appear dark gray, while sulphide minerals with relatively high average atomic numbers are lighter (Figure 17.7). The composition and mineralogy of grains can be determined with an Energy Dispersive X-ray Spectrometer (EDS) attached to the SEM.

The image produced from backscattered electrons from a polished surface can be used to identify structural deformities and weathering features and measure the size and arrangement of mineral grains (Figure 17.8). Under optimal detection conditions, the distribution of minor elements in a sulphide mineral may be identified from its impact on the average atomic number and the resulting differences in gray scale.

The secondary electron image produced from unpolished particles mounted on double sided sticky tape shows their topography and surface deformities.

Adding an Energy Dispersive X-ray Spectrometer (EDS) allows elemental analysis of mineral grains and other small areas of interest on the SEM image. EDS elemental analysis can be used to determine the mineral phase(s) associated with different shades of gray in the image produced from backscattered electrons. EDS analysis of rough surfaces can indicate the elements present. EDS major and minor element analysis of polished surfaces may be semi-quantitative or quantitative.

Digital image analysis using SEM/EDS can provide automated phase identification, elemental analysis and the relative determination of the grains. In addition, X-ray maps, in which colour intensity is correlated to increasing elemental concentrations, may show the relative concentrations of elements of interest in different minerals.

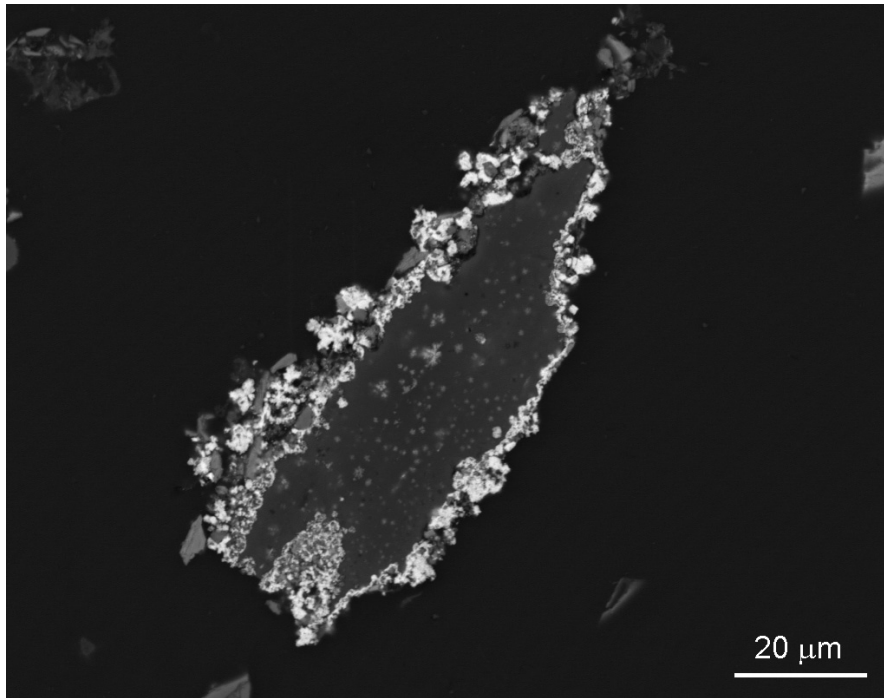
*Digital image analysis using SEM/EDS can provide automated phase identification, elemental analysis and determination of the relative distribution of different mineral phases.*

SEM can achieve a magnification roughly 100 times greater than that of an optical microscope. SEM/EDS is less expensive but has a detection limit approximately an order of magnitude higher than electron microprobe analysis (Petruk, 2000).

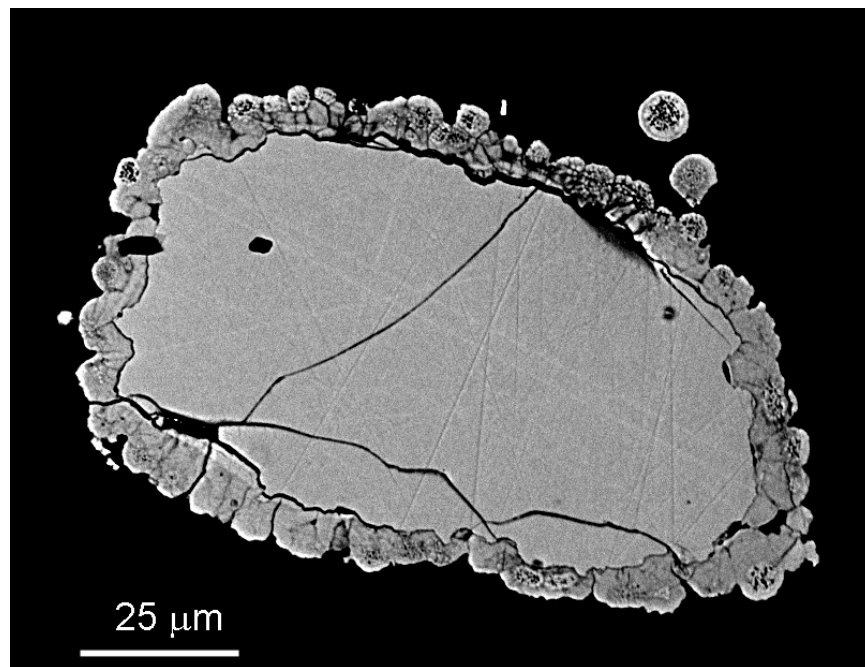
EDS detectors with beryllium windows are not capable of detecting elements lighter than sodium but modern detectors with ultrathin windows of organic film are capable of detecting boron, and some can detect beryllium.

SEM/EDS cannot distinguish minerals with the same composition but different crystal structures (polymorphs) such as pyrite and marcasite. Such minerals may be distinguished with XRD or in favourable cases by observing crystal habit with a petrographic microscope.





**Figure 17.7** Backscattered electron image of secondary chalcopyrite (light gray) deposited on carbon core (dark gray) (Jambor et al., 2005).



**Figure 17.8** Backscattered electron image of secondary pyrite (medium gray) as a rim on primary magnetite (light gray) (Jambor et al., 2005).



## 17.6 Electron Microprobe

Electron microprobe analysis is used for accurate and precise measurement of the elemental composition of mineral grains in polished sections of rocks or particles mounted in polished resin blocks. Wavelength Dispersion Spectrometry (WDS) is generally used in preference to EDS systems to measure characteristic X-rays produced from the surface of a sample. However, both WDS and EDS may be used together to optimize the acquisition of a large number of elements. WDS has superior peak resolution and more sensitivity to trace elements than EDS and therefore better precision and lower detection limits. The most cost-effective approach with an electron microprobe may be to use EDS to measure major elements and WDS to measure minor and trace elements.

*Electron microprobe analysis is used for accurate and precise measurement of the elemental composition of mineral grains in polished sections of rocks or particles mounted in resin blocks.*

As with SEM/EDS, the electron microprobe can produce characteristic X-ray maps of the elements in which colour intensity of the image is correlated to elemental concentrations. Electron microprobe X-ray maps show the relative concentrations of a particular element in different mineral grains and the relative distribution of the grains.

The detection limit for elemental analysis with an electron microprobe depends on the element, instrument, geologic material and operating conditions. A typical analysis of minor and trace elements takes 100 seconds with a detection limit of 200 to 500 ppm (Petruk, 2000). Trace element detection limits may be as low as 5 to 20 ppm using very high accelerating voltage, high beam current and long counting times (Robinson et al., 1998).

One of the most common uses of the electron microprobe for the prediction of drainage chemistry is the measurement of the elemental composition solid solution carbonate minerals, such as dolomite ankerite series, to determine their potential acid neutralization. An example of the electron microprobe analysis of the chemical composition of three different carbonate minerals is shown in Table 17.2. The chemical composition indicates the wt% and relative atoms per formula unit for net neutralizing  $Mg^{2+}$  and  $Ca^{2+}$  and not net neutralizing  $Mn^{2+}$  and  $Fe^{2+}$  in each carbonate mineral (Chapter 13).

Where the contribution of non-net neutralizing manganese and ferrous iron carbonates to NP results may lead to an erroneous drainage chemistry prediction, electron microprobe analysis of elemental concentrations of carbonate minerals (Table 17.2) and Rietveld analysis of the concentration of carbonate minerals (Table 17.1) can be used to calculate the relative proportion of net neutralizing magnesium and calcium and non-net neutralizing manganese and iron carbonates and to interpret the  $CO_3$ -NP and bulk-NP results (Table 17.3).

**Table 17.2 An example of electron microprobe analysis of the chemical composition of carbonate minerals (from the Kemess mine).**

Sample	Mineral	wt% oxide						# atoms / formula unit			
		MgO	CaO	MnO	FeO	CO <sub>2</sub>	Total	Mg <sup>2+</sup>	Ca <sup>2+</sup>	Mn <sup>2+</sup>	Fe <sup>2+</sup>
55-9	calcite	0.5	53.2	1.2	0.7	43.5	99.2	0.03	1.92	0.04	0.02
55-2	calcite	3.9	42.9	0.7	9.0	43.9	100.4	0.19	1.53	0.02	0.25
55-1	ankerite	11.7	20.9	0.4	22.0	42.9	97.8	0.59	0.77	0.01	0.63
55-8	ankerite	8.3	19.4	0.4	26.9	41.0	96.0	0.44	0.74	0.01	0.80
55-6	siderite	11.2	5.8	0.3	38.1	40.3	95.7	0.61	0.23	0.01	1.16
55-5	siderite	11.4	5.7	0.4	38.0	40.4	95.9	0.61	0.22	0.01	1.15
55-10	siderite	4.4	3.2	0.0	54.3	40.5	102.3	0.24	0.12	0.00	1.64

**Table 17.3 Electron microprobe and Rietveld analysis of XRD data can be used to interpret CO<sub>3</sub>-NP and Sobek-NP results (in kg CaCO<sub>3</sub>/tonne) (adapted from Frostad et al., 2003).**

Sample	Rietveld XRD (wt%)			XRD/microprobe NP		CO <sub>3</sub> -NP	Sobek-NP	
	Cal.	Ank.	Sid.	(CaMg)CO <sub>3</sub>	(FeMn)CO <sub>3</sub>		Fizz	NP
S1	0.3	7.1	5.9	47	74	138	Mod	102
S2		6.0	5.3	41	62	125	Slight	68
S3	7.2	1.5	4.5	83	42	130	Slight	86
S4	8.7	5.2	2.5	124	35	178	Mod	154
S5		6.4	2.4	42	40	108	Mod	95
S6	0.1	1.7	1.5	14	16	38	Slight	28
S7	12.9	4.7	1.1	160	21	173	Mod	168
S8	5.3		0.7	53	6	41	Slight	51

### 17.7 Laser Ablation and Other Microbeam Analyses

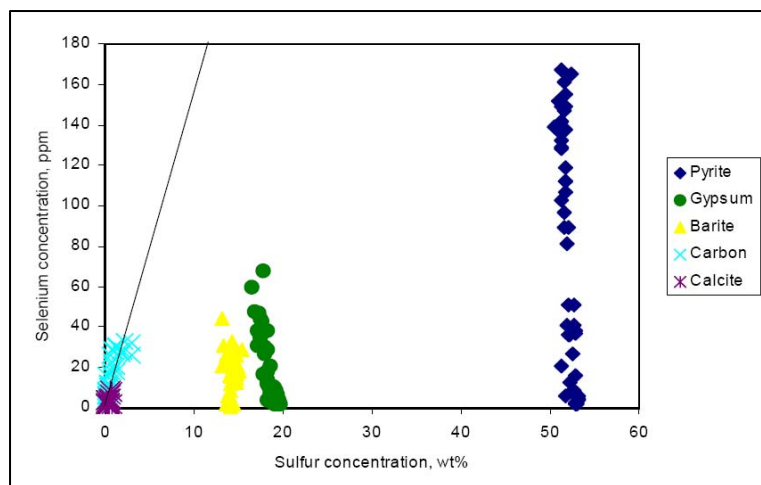
Laser ablation can be used to volatilize a small volume of a sample into constituents that are then analyzed by ICP-MS or some other system allowing measurement of the concentration of a large number of elements at low detection limits, as well as isotopes. There are no sample size limitations and little or no sample preparation requirements for direct solid chemical analysis using this technique. However, the ablation rate (quantity of mass ablated per laser pulse) varies with the sample matrix, and matrix matched standards are needed to account for potential fractionation of the ablated mass due to differences in thermal properties.

*In laser ablation, a laser beam volatilizes a volume of the sample into constituents that are then analyzed by ICP-MS or some other system allowing measurement of the concentration of a large number of elements at low detection limits.*

Laser ablation may be used for precise isotope analysis and the elemental analysis of thin layers of weathering and precipitated material or inclusions. Day and Sexsmith (2005) used laser

ablation to measure the concentration of selenium in reactive minerals at a coal mine experiencing elevated selenium in the drainage (Figure 17.9).

**Figure 17.9 Laser ablation measurements of selenium concentrations in reactive minerals (Day and Sexsmith, 2005).**



Proton Induced X-ray Emission (PIXE) is a microbeam method that provides quantitative multi-element analysis of polished sections and has a lower trace element detection limit than electron microprobe. Possible disadvantages are the greater area ( $> 50 \mu\text{m}$ ) required for analysis compared to the electron microprobe (Petruk, 2000).

Secondary Ion Mass Spectrometry (SIMS) of polished grains ( $> 40 \mu\text{m}$ ) also provides quantitative multi-element analysis and has a low trace element detection limit. A SIMS provides quantitative multi-element analysis for concentrations from approximately 10 ppb to 1% and can discriminate between isotopes of many elements (Petruk, 2000).

X-ray Absorption Spectroscopy (EXAFS, XANES) provides data on different oxidation states, types of bonding and adsorption modes (Warner et al., 2005). Analysis can be done on any state of matter, almost any sample (e.g. wet, dry, amorphous, etc.) and requires only minimal sample preparation (Henderson and Baker, 2002). Micro-XANES and synchrotron based Micro-XRD can provide information on oxidation state and identify finely intergrown phases (Walker et al., 2005).

## 17.8 Image Analysis

Image analysis using a Scanning Electron Microscope or electron microprobe can provide phase identification and quantification, elemental analysis and measurement of particle and grain size

*Image analysis using a Scanning Electron Microscope or an electron microprobe can provide phase identification and quantification, elemental analysis and measurement of particle and grain size distribution, mineral associations and the size and quality of inclusions.*

distribution, mineral associations and the size and number of inclusions. Image analysis may be performed as part of petrographic, SEM/EDS and electron microprobe analyses.

Mineral grains can be distinguished in SEM or electron microprobe backscattered electron images by their gray level, which is proportional to the average atomic number of the mineral. The gray levels may be assigned to the different mineral species and ambiguities can be resolved with EDS analysis.

Petrographic image analysis is uncommon because fewer minerals can be discriminated using this technique. Image analysis by SEM/EDS and electron microprobe also has the advantage of lower grain size detection limits, and the concomitant measurements of the elemental composition greatly improve mineral identification. Mineral grains  $> 1 \mu\text{m}$  can be distinguished at 400 times magnification (Petruk, 2000).

The steps in image analysis include image procurement and enhancement, mineral identification and measurement of the properties of interest. Automatic unattended mineral identification can occur once the gray level of different minerals is determined. Minerals can be discriminated based on their composition, rather than their gray scale, where minerals have the same average atomic number.

Characteristic X-ray element maps that show the presence of one or more elements or X-ray counts for different elements can be used to:

- identify minerals with different compositions;
- show the element distribution; and
- identify minerals containing minor or trace impurities of elements that potentially are problematic or have some analytical value (e.g. barium).

In the Quantitative Evaluation of Materials with the Scanning Electron Microscope (e.g. QEM-SEM and Mineral Liberation Analyzer), the backscattered electron image is used to determine the particle outline and EDS is used to identify the mineral. QEM-SEM and Mineral Liberation Analyzers are most commonly used for mineral identification in mineral processing (Lotter et al., 2002; Gu, 2003).

The general availability of SEM instrumentation makes point counting using SEM/EDS an increasingly attractive option, especially if it can be run automatically. Digital image analysis using SEM/EDS is limited by grain sizes smaller than the analytical volume of the electron microbeam (Raudsepp and Pani, 2003).

### 17.9 Calculation of Mineral Concentrations from Elemental Data

Calculation of the mineralogical composition from elemental data can range from the relatively

*Calculation of the mineralogical composition from elemental data can range from relatively simple to an entire mineral assemblage.*

simple calculation of the maximum potential concentrations of individual minerals from the concentrations of one or two elements, to the calculation of the concentrations of an entire mineral assemblage from the

elemental composition using normative computer programs. Elemental data can come from whole rock, near-total solid phase analysis or selective extraction of different fractions (Chapters 10 and 11).

While normative analysis is rapid and relatively inexpensive, large errors may result when:

- the mineralogy is unknown;
- elements occur in several minerals; and
- the elemental concentrations of some minerals are unknown.

For example, iron identified by whole-rock analysis may occur in acid generating pyrite, partially acid neutralizing calcium iron carbonate, silicate minerals and/or some form of iron oxide.

The ideal situation is where there is only one source for a particular element. For example, in un-oxidized sulphidic geologic materials, the lead concentration can be used to estimate the concentration of galena. Even simple assumptions should be made with caution as elements often occur as impurities in other common minerals.

The theoretical calculation in the software used to calculate normative mineral assemblages based on whole-rock geochemical data only applies to a limited number of mineral systems. The large number of potential permutations and combinations of mineral formation, alteration and composition will confound normative calculations for sulphidic geologic materials. Even with some ground truthing, accurate prediction of the entire mineral assemblage of sulphide rich systems based on normative analysis is not possible with our present level of technology.

### 17.10 Recommended Methods and Samples

Mineralogical analysis is generally recommended for a subset of samples representative of the range in the geochemical composition of the geologic units and project components (Chapters 6 and 7). Mineralogical analysis is also typically required for each kinetic test (Chapters 18 and 19), before and after testing. The number of samples will depend on variability in chemical and physical properties and the site specific prediction requirements (Chapter 8). As with other analytical procedures, selection of samples for analysis that are representative of the properties, materials and fractions of concern is critically important. Large differences in elemental concentrations (Chapter 10) will likely indicate large mineralogical differences.

The more lines of evidence available for consideration, the more accurate is the resulting mineral identification. Therefore it is preferable to conduct mineralogical analyses on samples for which other analyses and test data already exist, or will be produced. A visual mineralogical description and measurement of total and soluble elements, sulphur species and different forms of neutralizing potential will be needed for the selection of samples and interpretation of microscopic and sub-microscopic results.

Depending on the types of information and the required level of detail, different forms of mineralogical data may serve the purpose of an investigation. However, as a minimum, prediction programs generally should include visual descriptions, petrographic analysis and X-ray Diffraction analysis to identify and determine the abundance and spatial distribution of different minerals.

*As a minimum, prediction programs generally should include visual descriptions, petrographic analysis and X-ray Diffraction analysis.*

Mineralogical methods with lower elemental or areal detection limits, and the capacity to measure the elemental composition, such as SEM/EDS, electron microprobe and laser ablation, may be required to:

- identify mineralogy of grains too fine grained to be unambiguously identified by petrographic analysis;
- measure the elemental composition of amorphous mineral phases, mineral alteration features and solid solution minerals;
- identify mineral sources for potentially important elements; and
- measure the elemental concentration of impurities and inclusions.

Even more specialized analyses, such as proton induced laser ablation, Proton Induced X-ray emission (PIXE), Secondary Ion Mass Spectrometry (SIMS) and X-ray Absorption Spectroscopy (EXAFS, XANES), may be needed to provide extremely low detection limits or information on different oxidation states, types of bonding and modes of adsorption.

Mineral grain size, morphology, and textural relationships with other co-existing minerals are usually assessed by petrographic analysis or SEM. Image analysis is becoming a popular way to render the same information. SEM/EDS or electron microprobe image analysis may be used to measure properties of mineral grains, such as tailings fines, that are too small for petrographic analysis and to resolve discrepancies in the results of X-ray Diffraction and petrographic analysis.

Mineralogical analysis is a critical component of drainage chemistry prediction. Costs are approximately \$400-600 per sample for both Rietveld analysis of XRD data and petrographic analysis. These costs are similar to Acid Base Accounting analyses (Chapter 14), but are less than kinetic tests (Chapters 18 and 19). The cost of electron microprobe analysis to measure the relative magnitude of the calcium and magnesium portion of carbonate minerals costs approximately \$300 for six samples with five grains per sample. The opposing costs of inadequate mineralogical information may be prohibitive in terms of prediction errors, more expensive mitigation, delays in project approval and environmental risks.

### 17.11 Discussion

Accurate quantitative mineralogical data is both important and challenging to acquire. Careful

*Accurate quantitative mineralogical data is both important and challenging to acquire.*

planning is needed to obtain the required mineralogical information in a cost-effective and timely manner. There is no single, stand

alone mineralogical analysis. Each procedure has strengths and weaknesses and results should be checked using supplemental information provided by chemical analyses and other mineralogical procedures. For example, optical microscopy and bulk chemical analysis should be used to verify XRD mineral identification and quantification and to provide information on the spatial distribution of different mineral phases.

A review of the existing geological and mineralogical information in drill logs, exploration reports, metallurgical test work, geological surveys and research reports should be conducted

prior to selecting mineralogical procedures and samples. Mineralogical, along with geological and geochemical, data are collected during various stages of mineral exploration and in the metallurgical test work. As it becomes available, this information should be incorporated into the drainage chemistry prediction.

In most cases, information collected for other purposes will be inadequate and should be augmented with data from samples and microscopic and sub-microscopic analyses specifically selected for the prediction of drainage chemistry.

All forms of mineralogical analysis are dependent on the skill of the operator who runs the equipment and interprets the results. Geochemical, geologic and other relevant information provided in advance will help the mineralogists and petrographers to determine protocols for sample preparation and analysis and to interpret the results. Care should be taken to base mineral identification on firm evidence. The basis of educated guesses about aspects of mineral composition, such as previous analyses of other samples or theories of mineral and rock formation, should be identified.

Mineralogy is a specialized field of science. Laboratories with the equipment and persons with the knowledge to conduct the analyses and interpret the results may be in short supply.

Many of the more accurate and comprehensive mineralogical analyses are extremely time consuming and require expensive equipment. For example, quantifying the composition of solid solution minerals and the trace contaminants requires specialized sub-microscopic equipment. The available equipment and the time taken will determine the extent to which mineralogical analysis can be used in day-to-day operational material characterization prior to segregation.

## 17.12 References

Alpers, C.N., D.W. Blowes, D.K. Nordstrom and J.L. Jambor. 1994. Secondary Minerals and Acid-mine Water Chemistry. In: Environmental Geochemistry of Sulfide Mine Wastes. Mineralogical Association of Canada Short Course Series, Volume 22.

Day, S. and K. Sexsmith. 2005. Prediction of Selenium Leaching. In: Proceedings of 12th Annual British Columbia-MEND Metal Leaching/Acid Rock Drainage Workshop, Challenges in the Prediction of Drainage Chemistry. Vancouver, British Columbia, November 30-December 1.

Flemming, R.L., K.A. Salzsauler, B.L. Sherriff and N.V. Sidenko. 2005. Identification of Scorodite in Fine-grained, High-sulphide Arsenopyrite Mine-waste using Micro X-ray Diffraction ( $\mu$ XRD). Canadian Mineralogist. 43: 1243-1254.

Frostad, S., W.A. Price and H.G. Bent. 2003. Operational NP Determination – Accounting for Iron Manganese Carbonates and Developing a Site-Specific Fizz Rating. In: Proceedings of Sudbury 2003: Mining and the Environment Conference, Sudbury, Ontario, May 24-29.

Gu, Y. 2003. Automated Scanning Electron Microscope Based Mineral Liberation Analysis - An Introduction to JKMR/FEI Mineral Liberation Analyser. *Journal of Minerals & Materials Characterization & Engineering*. 2(1): 33-41.

Henderson, G.S. and D.R. Baker (eds.) 2002. *Synchrotron Radiation: Earth Environmental and Materials Sciences Applications*. Mineralogical Association of Canada Short Course Series, Volume 30.

Hurlbut, C.S. Jr., and C. Klein. 1985. *Manual of Mineralogy*. 21<sup>st</sup> Edition. John Wiley and Sons. p. 532.

Jambor, J.L. and D.W. Blowes. 1998. Theory and Applications of Mineralogy in Environmental Studies of Sulfide-bearing Mine Wastes. In: L. Cabri and D. Vaughn (eds.) *Modern Approaches to Ore and Environmental Mineralogy*. Mineralogical Association of Canada Short Course Series, Volume 27.

Jambor, J.L., M. Raudsepp and K. Mountjoy. 2005. Mineralogy of Permeable Reactive Barriers for the Attenuation of Subsurface Contaminants. *Can. Mineral*. 43: 2117-2140.

Kwong, Y.T.J. and K.D. Ferguson. 1990. Water Chemistry and Mineralogy at Mt. Washington: Implications to Acid Generation and Metal Leaching. In: *Acid Mine Drainage: Designing for Closure*. Proceedings of the GAC/MAC Joint Annual Meeting, Vancouver, British Columbia, May 16-18.

Lotter, N.O., P.J. Whittaker, L. Kormos, J.S. Stickling and G.J. Wilkie. 2002. The Development of Process Mineralogy at Falconbridge Limited, and Application to the Raglan Mill. In: *Proceedings of the 34<sup>th</sup> Annual Meeting of the Canadian Mineral Processors*, Ottawa, Ontario, January 22-24.

Pansu, M. and J. Gautheyrou. 2006. *Handbook of Soil Analysis Mineralogical, Organic and Inorganic Methods*. Springer Berlin Heidelberg.

Petruk, W. 2000. *Applied Mineralogy in the Mining Industry*. Elsevier. p. 268.

Raudsepp, M. and E. Pani. 2001. Quantitative Phase Analysis of Tailings and Waste Rock using the Rietveld Method and X-ray Powder Diffraction Data. In: *Proceedings of 8th Annual British Columbia Ministry of Energy and Mines - MEND Metal Leaching and ARD Workshop, New Developments, Different Aspects of Prediction and the Use of Water Covers as a Mitigation Strategy*. Vancouver, British Columbia, November 28-29.

Raudsepp, M. and E. Pani. 2003. Application of Rietveld Analysis to Environmental Mineralogy - Chapter 8. In: J.L. Jambor, D.W. Blowes and A.I.M. Ritchie (eds.) *Environmental Aspects of Mine Wastes*. Mineralogical Association of Canada Short Course Series, Volume 31.



Robinson, W., N.G. Ware and D.G.W. Smith. 1998. Modern Electron Microprobe Trace Element Analysis in Mineralogy. In: L.J. Cabri and D.J. Vaughan (eds.) Modern Approaches to Ore and Environmental Mineralogy. Mineralogical Association of Canada Short Course Series, Volume 27.

Thompson, A., W.A. Price, K. Dunne and J. Jambor. 2005. Guidelines for the Determination of Mineralogy and Mineralogical Properties. In: Proceedings of 12th British Columbia-MEND Metal Leaching/Acid Rock Drainage Workshop, Challenges in the Prediction of Drainage Chemistry. Vancouver, British Columbia, November 30 - December 1.

Walker, S.R., H.E. Jamieson, A. Lanzirotti, C.F. Andrade and G.E.M. Hall. 2005. The Speciation of Arsenic in Iron Oxides in Mine Wastes from the Giant Gold Mine, N.W.T.: Application of Synchrotron Micro-XRD and Micro-XANES at the Grain Scale. Canadian Mineralogist. 43: 1205-1224.

Warner, J.A., J. Olchoway, T. Kotzer and J.N. Cutler. 2005. Quantitative Analysis of Mixtures using Synchrotron XANES Spectroscopy. In: Proceedings of 12th British Columbia MEND Metal Leaching/Acid Rock Drainage Workshop, Challenges in the Prediction of Drainage Chemistry. Vancouver, British Columbia, November 30 - December 1.

Whittig, L.D. 1965. X-Ray Diffraction Techniques for Mineral Identification and Mineral Composition. In: C.A. Black (ed.) Methods of Soil Analysis, American Society of Agronomy. pp. 671-698.



## 18.0 HUMIDITY CELL PROCEDURES

### *Some Important Points in this Chapter*

*For sulphidic geologic materials, the decades old, well-flushed humidity cell with alternating dry and humid air is the recommended kinetic test for predicting primary reaction rates under aerobic weathering conditions. The resulting data provide primary rates of elemental release, acid generation and acid neutralization. This information can provide site specific NPR criteria for interpreting ABA data (Chapter 14) and, when combined with solid phase analyses, also provide depletion times for NP, sulphide and various elements. However, these cells do not usually simulate the precipitation and dissolution of secondary weathering products, which often determine drainage chemistry under field conditions. Cells should continue until rates have stabilized at relatively constant levels for at least five weeks. When a cell is terminated, the closedown procedure should be conducted for better interpretations and for post-test validation of cell results.*

### 18.1 Introduction

For sulphidic geologic materials, the well-flushed humidity cell is the recommended kinetic test

*The well-flushed humidity cell is the recommended kinetic test for predicting primary reaction rates under aerobic weathering conditions.*

for predicting primary reaction rates under aerobic weathering conditions. The resulting data provide a measure of the rates of elemental release, acid generation and acid neutralization under the geochemical conditions encountered in the test.

Measured rates can be used to estimate the time to mineral exhaustion. The balance between the rates of acid generation and acid neutralization can be used to predict future geochemical conditions like pH, one of the critical pieces of information needed for setting site specific waste disposal criteria. There are also conditions under which humidity cell results can directly predict drainage chemistry.

#### 18.1.1 Advantages of the Humidity Cell

Advantages of well-flushed humidity cells include:

- consistent reproducible test conditions of humidity cell testing permits the comparison with results from other sites; and
- weekly flushing permits measurement of the primary reaction rates.

The last advantage should be qualified. Flushing will only remove those weathering products that are water soluble. The assumption that base cations and sulphate, which are the parameters used to determine the rates of acid generation and neutralization, are water soluble should be checked as part of the test.

### 18.1.2 Simulated Weathering in a Humidity Cell versus Weathering in the Field

Compared to field conditions, humidity cells:

- are restricted to finer particles, typically < 10 mm in diameter, which are usually more reactive and expose all reactive grains (Chapters 8 and 16);
- are operated at room temperature with regular cycles of dry and humid air and regular rinsing with deionized or distilled water;
- have less heterogeneity in leaching;
- do not conserve heat generated by sulphide oxidation; and
- minimize accumulation of soluble secondary weathering products.

Because of the differences noted above, the well-flushed humidity cell procedure clearly does not usually simulate the precipitation and dissolution of secondary weathering products, which often determine drainage chemistry under field conditions.

*The well-flushed humidity cell procedure clearly does not usually simulate the precipitation and dissolution of secondary weathering products, which often determine drainage chemistry under field conditions.*

Laboratory conditions in tests like humidity cells may enhance or depress rates of sulphide oxidation, leaching rates and carbonate dissolution relative to field conditions. Some processes which can cause discrepancies between laboratory and field rates include:

- any accumulation of secondary minerals in cells may occur at a different rate;
- pretreatment grinding and crushing may damage mineral grains, exposing soluble base cations and hydroxides, making the minerals more susceptible to weathering and creating additional acid potential and/or neutralization potential compared to what may be operationally available;
- the portion able to contribute to drainage chemistry may be much larger in a crushed humidity cell sample than in the actual waste rock and pit walls; and
- pretreatment comminution does not discriminate between high and low strength portions of the rock and thus the fines in the test sample may include material that, due to its physical stability, would normally occur as coarse fragments or relatively unfractured mine walls.

## 18.2 Humidity Cell Procedure

The following description of the humidity cell procedure includes:

- a description of the apparatus;
- an outline of the general procedure;
- information on sample preparation; and
- detailed descriptions of start-up, operating and closedown procedures.

This information follows the original procedure of Sobek et al. (1978) with a minor modification to handle larger sample sizes.

### 18.2.1 Apparatus

The recommended humidity cell design is a plexiglass cylinder fitted with a base plate and equipped with a drain hole, a detachable lid and various other air and drainage ports (Figures 18.1 to 18.3). Approximately 2.5 cm (1 inch) from the bottom of the base plate is a removable perforated plate or screen which supports the sample. Filter materials, such as polypropylene landscape fabric, should be used to minimize the amount of fine particles passing through the perforated plate. Some fabrics have been shown to leach metals so an acid wash should be performed on all materials beforehand.

The size and shape of the humidity cell will depend on the particle size of the material being tested (e.g. waste rock versus tailings). If the sample consists of relatively porous material (i.e. predominantly sand and gravel sized particles) the humidity cell should be approximately 20 cm (8 inches) high and 10 cm (4 inches wide) (Figure 18.1). This tall slender humidity cell is typically used for waste rock samples, which are crushed to approximately -6 mm (-¼ inch). If the sample consists of tailings like material with finer particles (approximately 150 µm) and less permeability, a shorter, wider cell should be used in order to facilitate leaching and aeration (Figure 18.2).

### 18.2.2 General Outline of the Procedure

One critical requirement for humidity cell test work that should never be omitted is the pre-test and post-test characterization of the original sample and the resulting residue. Analyses should include expanded ABA, strong acid digestion multi-element analysis by ICP, mineralogy, whole-rock major element analysis and particle size (Chapters 10 to

*One critical requirement for humidity cell test work that should never be omitted is the pre-test and post-test characterization of the original sample and the resulting residue.*

17). Pre-test information is used to identify possible sources of element release and to calculate the rates and times to depletion for different minerals, elements, acidity and alkalinity sources. Post-test characterization can verify any large physical or geochemical changes in the sample during testing and can identify any accumulated weathering products.

Where some aspect of the pre-test composition suggests a significant weathering reaction may be masked during testing, pretreatment may be required to remove it. The most common example of this is where a sample contains an abundant, soluble sulphate mineral (e.g. gypsum) whose dissolution products cannot be distinguished from the sulphate released by sulphide oxidation and the calcium released from calcite.

After sample preparation and pre-test characterization, approximately 1 kg of the test sample (dry weight) is placed in the humidity cell and arranged so that the top surface is relatively flat. In the initial week (Week 0) the test sample is wetted and flushed/rinsed (Section 18.2.4). This is followed by a repetitious, weekly cycle of dry air, humid air and flushing (Section 18.2.5). For the air treatments, air is continuously pumped into and through the cell. A dry air manifold is required for the three day per week dry air treatment. A humidifier is required for the water saturated air treatment.

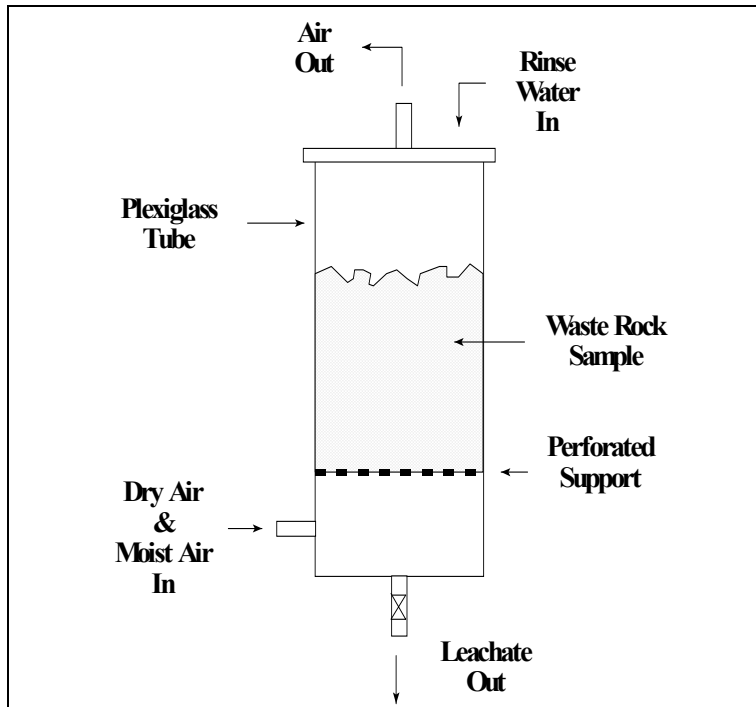


Figure 18.1 Humidity cell for waste rock.

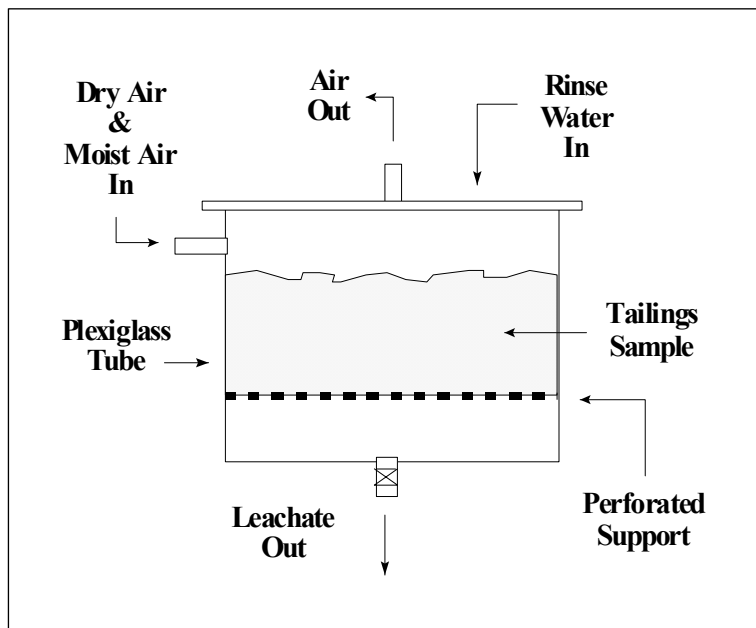


Figure 18.2 Humidity cell for tailings.



**Figure 18.3** Photograph of humidity cells being used for waste rock.

The pattern of air flow differs between the tailings and waste rock cells. This difference mirrors differences in field deposition and water retention characteristics. Tailings are typically fine materials with high moisture contents and are usually placed as a slurry into an impoundment. Usually the only “fresh” air in constant contact with the tailings is that which passes over the top of the tailings mass. Subsequent air movement into the tailings is through diffusion, a slow process that limits the downward movement of oxygen (Chapter 7). Waste rock, on the other hand, is usually coarser than tailings and is placed in piles or dumps. The larger particle size allows for better drainage, more contact between the waste rock and air, and greater air

circulation. As a result, air in a waste rock cell is introduced below the sample so that it can more freely circulate through it, while in a tailings cell air is passed over top of the sample.

One testing “cycle” takes place over seven days (Section 18.2.5). The first three days of the cycle is the dry portion during in which filtered laboratory air is passed over the tailings sample or through the waste rock sample. The next three day period is the wet portion of the testing cycle, when laboratory air is first pumped through a humidifier unit and then into a cell.

On the final day of the testing cycle, 500 mL of distilled/deionized water is added to the top of the cell and allowed to soak the sample for at least two hours to dissolve the weekly accumulated weathering products. Finer grained samples should be gently stirred to ensure particle surfaces are rinsed. The rinse water is then drained for analysis. The day after collecting the rinse/flush sample, another cycle is initiated with the introduction of dry air. A detailed description of the startup, operating and closedown procedures is presented below.

The weekly “leachate” or rinse water should be analyzed for pH, sulphate, conductivity, acidity, alkalinity, and multi-element ICP analysis. Water samples should be immediately filtered to provide dissolved concentrations. From the analyses, leaching rates can be calculated, typically in units of mg of parameter/kg of sample/week. Based on pre-test static tests such as ABA and multi-element ICP analysis, times to metal depletion can also be calculated.

The humidity cell test ends when the rates of sulphate generation and metal leaching have stabilized at relatively constant rates for at least five weeks. Experience shows that stabilization often takes 40 weeks, and can sometimes take over 60 weeks, and significant changes may take place even after several years. Therefore, the decision of whether to close down a cell depends on the site specific objectives and the degree of uncertainty in the predictions. Because of the uncertainty and associated risks, some mines have continued kinetic tests for more than a decade.

*The humidity cell test ends when the rates of sulphate generation and metal leaching have stabilized at relatively constant rates for at least five weeks.*

### 18.2.3 Sample Preparation

Sample preparation requirements depend on the specific material, site and depositional conditions. The main guideline is that the test material, particle size and mineral exposure should, to the extent possible, match the material that will react in the field. General recommendations for different materials are as follows:

- do not grind existing fine grained materials;
- for existing waste rock, use a particle size fraction representative of the reactive material (e.g. the < 2 mm fraction), which can be separated by sieving;
- for existing tailings use the entire sample;
- for bedrock or drill core samples of future waste rock, use an entire rock sample ground to 80% < 6 mm (< ¼ inch); and
- for bedrock or drill core samples of future ore, use the entire rock sample ground to 80% < 6 mm to simulate ore stockpiles or < 150 µm to simulate tailings.



### 18.2.4 Humidity Cell Startup Procedure

1. A minimum 2 kg of sample is required for humidity cell testing and pre-test characterization. Record sample information on a humidity cell pre-test sample information sheet (Figure 18.4).
2. The beginning of the humidity cell test program will be Week 0. Humidity cells are operated on a weekly cycle.
3. If the sample is rock, crush the sample as required above (Section 18.2.3). If the sample is fine tailings, crushing is not required and the sample is normally tested as received.
4. Split out sufficient representative portions of the sample and send it for the static tests discussed in Chapters 10 to 17. Record information on the pre-test sample information sheet. Label these results “pre-test data”.
5. Weigh 1000 g of sample, record the weight and carefully place it in the appropriate humidity cell, either for waste rock or tailings (Figures 18.1 and 18.2). If the sample is moist, determine its water content so a dry weight can be calculated. Ensure the sample has a relatively level surface in the cell.

#### 18.2.4.1 Procedures for Week 0

6. Clamp the drain hose at the bottom of the cell. Carefully add a known volume of demineralized/deionized water, approximately 750 mL, to the top of the humidity cell. Enough demineralized/deionized water should be added to the sample to thoroughly moisten the sample and allow for collection of at least 300-500 mL of leachate. Record the amount of water added on a weekly data sheet (Figure 18.5). Put a collection flask under the cell so that the hose drains into it. All of the sample must have good contact with the water, therefore gently agitate (i.e. gently stir so that the entire sample is in contact with water) fine samples for about one minute.
7. Allow rock samples to soak for approximately 2 hours and tailings samples to soak for approximately 4 hours, allowing dissolution reactions to occur and any suspended particles to settle. Disconnect the hose clamp and drain off the leachate into the collection flask. If the cell will not drain in a reasonable time (i.e. a few hours), check to see if the drainage hose is blocked. If the leachate still will not drain, carefully decant the leachate off the top of the sample. Record the volume of leachate collected (Figure 18.5).
8. Note: If excess solids flow from the humidity cell with the leachate, it may be necessary to recover the solids by filtering the leachate through coarse filter paper. Obtain the weight of a clean filter flask, then transfer as much of the solids as possible from the collection flask to the filter apparatus by swirling it before transferring it. Weigh the filtrate plus the filter flask; record the weight. Record the volume of the filtrate. Keep a record of all weights and calculations. Return as much of the solid material as possible back into the humidity cell (See Step 12).
9. Immediately filter the leachate through a 0.45  $\mu\text{m}$  filter into two sub-samples; a 500 mL polyethylene bottle (“raw”) and a 100 mL polyethylene bottle acidified with  $\text{HNO}_3$  to a pH < 1.5. Label the bottles with the project name, sample ID, cycle number and date. Record all data for this initial rinse as Week or Cycle 0. When filtering is very slow, the leachate can be centrifuged.
10. Place approximately 25 mL of the “raw” leachate in a 30 mL beaker and perform pH and conductivity measurements on the sample using calibrated instruments. Record all results.

For all analyses keep a record of the instruments used, all QA/QC procedures and any data resulting from calibration.

11. Submit the remaining “raw” leachate immediately for acidity, alkalinity and sulphate analysis. Submit the filtered, acidified sample for ICP element analysis. This suite of analyses will be done weekly. Additional work may be required according to the sample and the type of information needed (i.e. some samples may require additional analyses such as: low level arsenic and/or mercury, Cl, F, P, nitrate, nitrite, TDS, etc.).
12. Carefully scrape any residue in the filter apparatus back into the humidity cell, taking care not to introduce contamination into the humidity cell. When the filter paper and residue have dried return any solids back to the humidity cell.

<b>HUMIDITY CELL TESTING PROGRAM PRE-TEST DESCRIPTIVE SAMPLE INFORMATION SHEET</b>	
Company:	
Project:	
Sample ID:	
Sample Type (waste rock, tailings, etc.):	
Sample Submission Date:	
Submitted To:	
Submitted By:	
Sample Description (colour, smell, texture, size distribution, moisture content, etc.):	

**Figure 18.4 Pre-test sample description form for kinetic samples.**

## 18.2.4.2 QA/QC Procedures for Week 0

12. Take a sample of the demineralized water used as humidity cell rinse water and process it through a blank cell. Handle and filter the sample as was done with the humidity cell leachate. Measure the pH and conductivity of the sample. Label the sample "Method Blank" and submit it for analysis.
13. Take a sample of the demineralized/deionized water used for leaching the cells (do not process it in any way). Label it "Rinse Water" include the cycle/week number and date and submit it for analysis.

KINETIC TEST - WEEKLY DATA SHEET							
PROJECT: Mine A							
CELL NO.: A-4							
SAMPLE ID./DESCRIPTION: Sample 45964 (Dump #6 - Waste Rock)							
Week/ Cycle	Date	Leachate Volume Added (mL)	Leachate Volume Recovered (mL)	pH	Conductivity ( $\mu$ S/cm)	Humidifier Water Temp ( $^{\circ}$ C)	Comments /Analyst
0	12-Feb-96	750	430	6.68	425	30.5	Filtered solids returned to cell. Water drained well. <i>NH</i>
1	19-Feb-96	500	427	6.96	505	30.5	Filtered solids returned to cell. Water drained slowly. <i>KM</i>
2	26-Feb-96	500	471	7.21	311	30.5	Filtered solids returned to cell. <i>NH</i>

**Figure 18.5** An example of a weekly report form for humidity cell kinetic testing.

### 18.2.5 Humidity Cell Weekly Operating Procedure

This procedure generally adheres to the objectives of Sobek et al. (1978), but is modified in places to allow for larger samples.

1. For the first three days after the weekly rinse, dry air is pumped into the humidity cell. Connect the humidity cell to a dry air source, use a gentle flow rate to move the air through (waste rock) or over (tailings) the sample. Monitor the air flow rate to ensure that consistent air flow is maintained. If more than one humidity cell is running, splits can be taken from a main air line leading to each humidity cell. Use hose clamps to ensure that each cell receives roughly the same, constant rate of air flow. After 3 days of dry air, check that the cell contents appear dry.
2. On the morning of the fourth day, a three day wet air cycle begins. Switch the air supply from a dry source to a humid one. Disconnect each humidity cell from the main dry air supply line. Connect each cell to a nipple on the humidifier. The humidifier should be roughly half full of water and contain an immersion heater which is set to  $\sim 30^{\circ}\text{C}$ . The air

from the main dry air supply is switched to pass through the humidifier unit. This air passes through the humidifier and exits from an aquarium type diffuser. The air pressure is adjusted to provide an adequate air flow without causing rolling waves in the humidifier. Again, if more than one humidity cell is running, use hose clamps associated with each humidity cell to ensure that each cell receives roughly the same, constant air flow rate.

3. On the seventh day, the rinsing and sampling procedures begin. Shut off the main air supply. Disconnect the air supply hose from each of the humidity cells and clamp them shut. Note: The waste rock cells have the air inlet at the bottom and will allow leach water to drain back into the humidifier if it is not clamped. Disconnect the immersion heater and record the water temperature and the pH of each humidifier.
4. Ensure that the drain hose at the bottom of the cell is clamped. Place a clean 500 mL beaker under each cell with the hose draining into it. Carefully add 500 mL of demineralized/deionized water to the top of each humidity cell. Record the amount of water added. Since all of the samples must be in contact with the water, gently agitate finer samples for about one minute before and after the addition of water. Make note of how each cell is treated in the weekly records (Figure 18.5).
5. Allow rock samples to soak for approximately 2 hours and tailings samples to soak for approximately 4 hours to allow complete dissolution and any suspended particles to settle. Disconnect the hose clamp and drain off the leachate into the collection flask. If the cell will not drain in a reasonable time (i.e. a few hours), check to see if the drainage hose is blocked. If the leachate still will not drain, carefully decant the leachate off the top of the sample. Record the volume of the collected leachate.  
Note: If excess solids flow from the humidity cell with the leachate, it may be necessary to recover the solids by filtering the leachate through coarse filter paper. Obtain the weight of a clean filter flask, then transfer as much of the solids as possible from the collection flask to the filter apparatus by swirling it before transferring it. Weigh the filtrate plus the filter flask; record the weight. Record the volume of the filtrate. Keep a record of all weights and calculations. Return as much of the solid material as possible back into the humidity cell (See Step 9).
6. Immediately filter the leachate through a 0.45  $\mu\text{m}$  filter into two sub-samples; a 500 mL polyethylene bottle (“raw”) and a 100 mL polyethylene bottle acidified with  $\text{HNO}_3$  to a pH < 1.5. Label the bottles with the project name, sample ID, cycle number and date. Record all data for this initial rinse as Week or Cycle 0. When filtering is very slow, the leachate can be centrifuged.
7. Place approximately 25 mL of the “raw” leachate in a 30 mL beaker and perform pH and conductivity measurements on the sample using calibrated instruments. Record all results. For all analyses keep a record of the instruments used, all QA/QC procedures and any data resulting from calibration.
8. Submit the remaining “raw” leachate immediately for acidity, alkalinity and sulphate analysis. Submit the filtered, acidified sample for ICP element analysis. This suite of analyses should be done weekly. Additional assays may be required according to the sample and the type of information needed (i.e. some samples may require additional analyses such as: low level arsenic and/or mercury, Cl, F, P, nitrate, nitrite, TDS, etc.).
9. Carefully scrape any residue in the filter apparatus back into the humidity cell, taking care not to introduce contamination into the humidity cell. Place the filter paper on top of the humidity cell to dry it, ensuring it will not be disturbed. When the filter paper and residue have dried return any solids back to the humidity cell.

10. Record observations regarding low hydraulic conductivity, colour changes or any physical changes during operation of the test – this could be information used during the interpretation of the data.

#### 18.2.5.1 QA/QC Procedures for Weekly Operation

11. Take a sample of the demineralized/deionized water used as humidity cell rinse water and process it through the blank cell. Handle and filter it as was done with the humidity cell leachate. Measure the pH and conductivity in the resulting leachate sample. Label the sample “Method Blank” and send it for analysis.
12. Take a sample of the demineralized water used for leaching the cells (do not process it in any way). Label it “Rinse Water”, include the cycle/week number and date and submit it for analysis.
13. Humidifier maintenance: Humidifiers should be cleaned out every three months, or if the water appears turbid. Also, replace the tubing whenever necessary.
14. Interpretation of the results is discussed in Section 18.3.

#### 18.2.6 Humidity Cell Closedown Procedure

1. When the cell has stabilized geochemically or reached the selected geochemical end point, it can be terminated if desired. To allow a proper interpretation of the cell results, specific closedown sampling and analysis procedures should be carried out and included in data interpretation.  

*To allow a proper interpretation of the cell results, specific closedown sampling and analysis procedures should be carried out.*
2. After the last cycle, rinse and collect the leachate as per the humidity cell operational procedures (Section 18.2.5).  
Note: The rinse from the last cycle must be submitted for the full suite of analyses.
3. Remove the sample from the test cell and place it into a clean 4 L polyethylene rotary jar or other water-tight plastic container. To ensure that the test cell has been thoroughly cleaned and all of the sample and associated precipitates have been transferred to the rotary jar, use a known amount of demineralized/deionized water of known composition to wash the cell. Add enough additional demineralized/deionized water to the rotary jar so that a total of 3 L of demineralized/deionized water has been added.
4. Gently agitate the sample on a gyratory shaker or bottle roll device for a period of 24 hours. On completion of the 24 hour agitation, let the sample stand for a minimum of three hours allowing the suspended materials to settle.
5. Collect the supernatant, recording its volume. Handle and prepare the sample in the same manner as was done during the normal humidity cell operation. Label the sample “Final Leach” and submit it for leachate analysis.
6. Transfer the wet solids from the rotary jar to a pre-weighed drying tray, ensuring the entire sample has been moved. Record the weight of the wet sample.
7. Air dry the wet sample, or dry it in an oven on low heat (< 40°C) if necessary. Record the final weight of the dry sample. If sample was dried in an oven, cool it in a desiccator prior to weighing.

8. Take a representative split from the sample and label it “Final Residue”. Submit the split for comprehensive compositional analysis. These analyses will be known as “Post-Test Data”.
9. Package the remaining sample and label it “Final Residue”. Place it in cold storage for possible later examination.
10. Interpretation of the results is discussed in Section 18.3.

### 18.3 Interpretation of Humidity Cell Tests

The primary objectives of humidity cell tests are to:

- measure reaction rates under specific geochemical conditions; and
- to calculate depletion times for acid generating, acid neutralizing, and metal leaching minerals.

The first step in the interpretation of kinetic test results is the calculation of these values.

One of the major problems with humidity cell work in the past was the short duration of the tests.

*One of the major problems with humidity cell work in the past was the short duration of the tests.*

Kinetic tests should be operated until weekly rates become relatively stable. For humidity cells, this can require at least 40 weeks of testing and may require more than a year. In order to remove the effect of natural weekly variations, stable rates are arbitrarily defined as the average of the last five weeks of testing. Rates should be compiled into a table for ease of prediction and for reporting.

Calculations of the time to NP depletion and ARD onset include the inherent assumption that the measured “stable” rates will persist. This allows the results to be extrapolated into the future. Unfortunately, there is very little long term data to check this assumption.

Studies have indicated that stable rates from humidity cells can persist within a factor of two for at least five years (Day, 1994). Rates can not remain the same forever; however, if the mineralogical data shows the contributing minerals will not be exhausted, it can be assumed that the calculated rates, which will be used for predictions of drainage chemistry, will persist for decades. The accuracy of this assumption can be addressed by ongoing testing and monitoring.

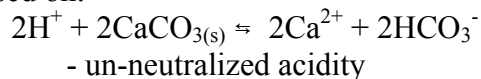
The calculation of rates and depletion times are best accomplished by entering all weekly data into spreadsheets that will allow data manipulation. Recommended equations for calculating derived parameters are listed in Table 18.1. The Acid Generation section includes calculations for the rates of total and measurable (remnant) acid generation by weight and surface area and the remaining amounts of acid generating sulphur. The Molar Ratio section lists two of the many possible ratios of NP:AP consumption based on the mineralogy of the NP minerals (Chapters 13 and 14). The rates for Acid Neutralization and NP Consumption vary according to the mineralogy of NP minerals and environmental conditions, particularly whether the system is opened or closed to CO<sub>2</sub>. Depletion equations for NP under various conditions are included. The final section of the table on Metal Leaching provides the basic equations for rate and depletion which should be applied to all elements. Where metal concentrations in mg/L are below detection, one-half of the detection limits can be used for rate calculations.

**Table 18.1 Recommended equations for interpreting laboratory kinetic tests.**

<p><b>Acid Generation</b></p> <p><u>Acidity Production Rate</u> (mg CaCO<sub>3</sub>/kg/wk) = Acidity (mg CaCO<sub>3</sub>/L) x Volume Leachate Collected (L) / Sample Weight (kg)</p> <p><u>Sulphate Production Rate</u> (mg/kg/wk) = Sulphate (mg/L) x Volume Leachate Collected (L) / Sample Weight (kg)</p> <p><u>Remaining total-S</u> (% of original) = {[Initial total-S (%) - ((Cumulative Sulphate Production Rate (mg/kg) x 32.06 / 96.06) / 10000)] / Initial total-S (%)} x 100%</p> <p><u>Remaining sulphide-S</u> (% of original) = {[Initial sulphide-S (%) - ((Cumulative Sulphate Production Rate (mg/kg) x 32.06 / 96.06) / 10000)] / Initial sulphide-S (%)} x 100%</p> <p><u>Sulphate Production Rate By Surface Area</u> (mg/m<sup>2</sup>/wk) = Sulphate Production Rate (mg/kg/wk) / Surface Area (m<sup>2</sup>/kg)</p>
<p><b>NP Molar Ratios</b></p> <p><u>Carbonate Molar Ratio</u> = [(Ca (mg/L)/40.08) + (Mg (mg/L)/24.31)] / (SO<sub>4</sub> (mg/L)/96.06)</p> <p>Other ratios may be used depending on the source of alkalinity, for example:</p> <p><u>Feldspar Molar Ratio</u> = [(Ca (mg/L)/40.08) + (K (mg/L)/2*39.1) + Na (mg/L)/(2* 22.99)] / (SO<sub>4</sub> (mg/L)/96.06)</p>
<p><b>Acid Neutralization and NP Consumption</b></p> <p><u>Carbonate Ratio NP Consumption</u> (mg CaCO<sub>3</sub>/kg/wk) = Carbonate Molar Ratio x Theoretical NP Consumption (mg/kg/wk);</p> <p>based on:</p> $2\text{H}^+ + \text{SO}_4^{2-} + (\text{Ca}_z\text{Mg}_{1-z})\text{CO}_3(\text{s}) \rightleftharpoons z\text{Ca}^{2+} + (1-z)\text{Mg}^{2+} + \text{SO}_4^{2-} + \text{H}_2\text{CO}_3^0$ $2\text{H}^+ + \text{SO}_4^{2-} + 2(\text{Ca}_z\text{Mg}_{1-z})\text{CO}_3(\text{s}) \rightleftharpoons 2z\text{Ca}^{2+} + (2-2z)\text{Mg}^{2+} + \text{SO}_4^{2-} + 2\text{HCO}_3^-$ <p><u>Theoretical NP Consumption at pH 6</u> (mg CaCO<sub>3</sub>/kg/wk) = Sulphate Production Rate (mg SO<sub>4</sub>/kg/wk) x 100.09 / 96.06;</p> <p>based on:</p> $2\text{H}^+ + \text{SO}_4^{2-} + \text{CaCO}_3(\text{s}) \rightleftharpoons \text{Ca}^{2+} + \text{SO}_4^{2-} + \text{H}_2\text{CO}_3^0$ <p><u>Empirical Open System NP Consumption around Neutral pH</u> (mg CaCO<sub>3</sub>/kg/wk) = Theoretical NP Consumption (mg/kg/wk) + Alkalinity Production Rate (mg/kg/wk) - Acidity Production Rate (mg/kg/wk);</p> <p>based on:</p> $2\text{H}^+ + \text{SO}_4^{2-} + \text{CaCO}_3(\text{s}) \rightleftharpoons \text{Ca}^{2+} + \text{SO}_4^{2-} + \text{H}_2\text{CO}_3^0$ <p>plus <math>\text{H}_2\text{CO}_3^0 + \text{CaCO}_3(\text{s}) \rightleftharpoons \text{Ca}^{2+} + 2\text{HCO}_3^-</math></p> <p>- un-neutralized acidity</p>

Theoretical Closed System NP Consumption above pH 6.5 (mg CaCO<sub>3</sub>/kg/wk) = [Theoretical NP Consumption (mg/kg/wk) x 2] - Acidity Production Rate (mg/kg/wk);

based on:



Remaining NP (% of original) = {[Initial NP (t CaCO<sub>3</sub>/1000 t) - (Cumulative NP Depletion Rate (mg/kg) / 1000)] / Initial NP (tonnes CaCO<sub>3</sub>/1000 tonnes)} x 100%

### **Metal Leaching**

Metal Leach Rates (mg/kg/wk) = Metal Concentration (mg/L) x Volume of Leachate Collected (L) / Sample Weight (kg)

Remaining Metal (% of original) = {[Initial Metal Content (mg/kg) - Cumulative Metal Leach Rate (mg/kg)] / Initial Metal Content (mg/kg)} x 100%

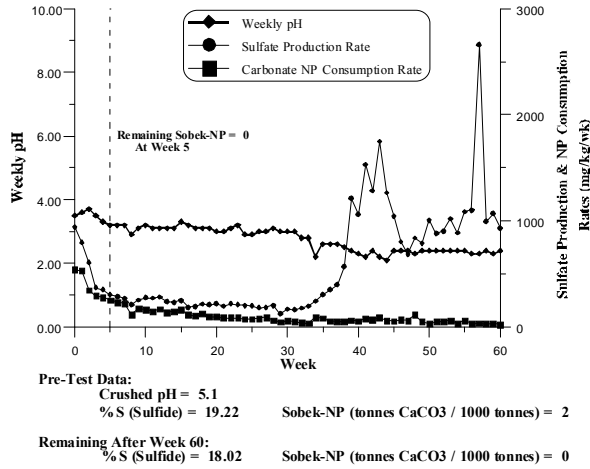
Note: At later stages of some humidity cell testing programs, analyses for sulphate, alkalinity and metals are not necessarily done on a weekly basis but may be decreased to monthly. In this circumstance, weekly values for rates can be calculated through interpolation of the preceding and subsequent measured values.

All humidity cell data should be compiled and evaluated periodically. The best way to show trends or the association between different parameters is to plot the results. Examples of plots of the humidity cell results for pH, rates of sulphate production (sulphide oxidation), NP consumption rates and metal leaching rates for British Columbia mine rock are shown in Figures 18.6 to 18.9. Discussions accompanying these figures illustrate the interpretation of humidity cell results.

*The best way to show trends or the association between different parameters is to plot the results.*

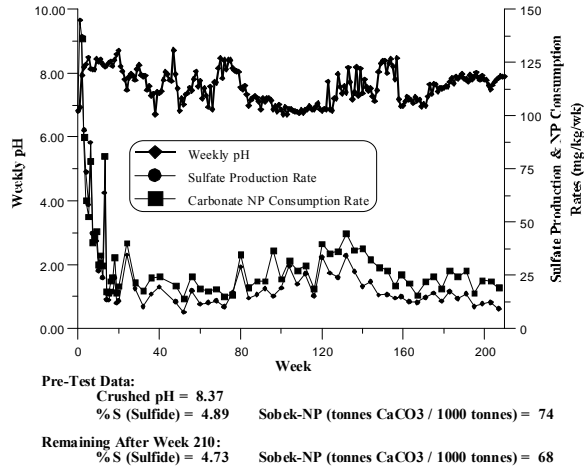


### Acidic pH Throughout Test



a) waste rock; NP non-existent from start; NP rate always less than sulphate rate during test; sulphate rate increasing and pH decreasing during test; late-term sulphate rate around 1000 mg/kg/wk

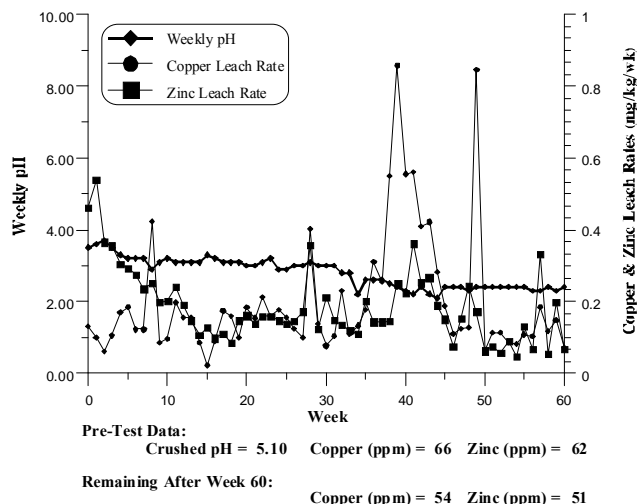
### Near-Neutral pH Throughout Test



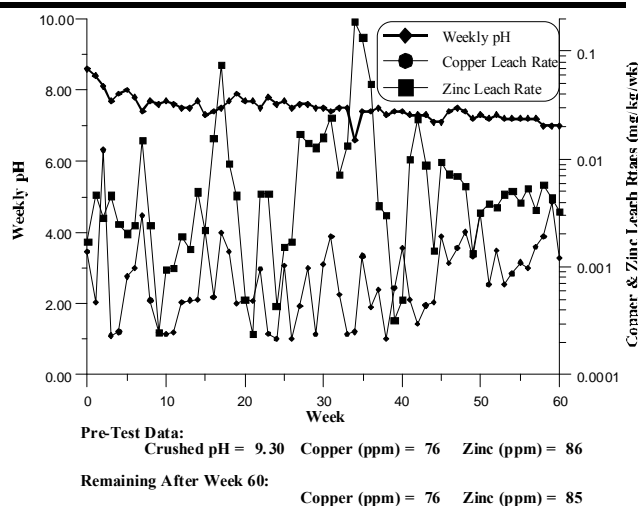
b) waste rock; NP rate about 50% higher than sulphate rate over 210 weeks; rates generally stable after Week 30 with gradual factor-of-two rise and fall around Week 130; abundant sulphide and NP remaining after 210 weeks

**Figure 18.6 Humidity cells that remained acidic or near neutral, showing leachate pH and rates of sulphate production (sulphide oxidation) and NP consumption.**

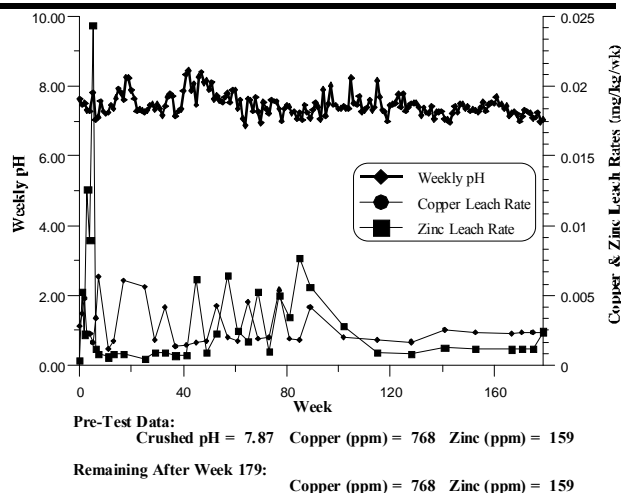
a) consistently acidic; peak copper and zinc rates around Week 40; rates generally steady after Week 50



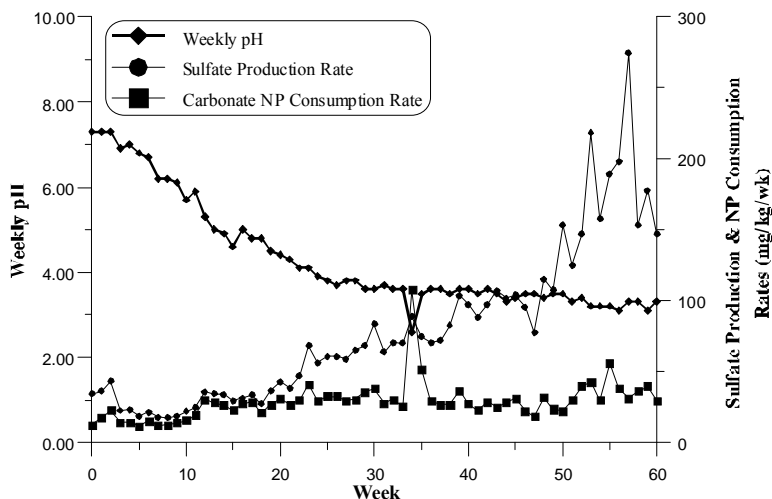
b) consistently near neutral pH; fluctuating copper and zinc rates generally within steady ranges throughout test



c) consistently near neutral pH; fluctuating copper and zinc rates generally within steady ranges throughout test except for peaks in early weeks suggesting rinsing of accumulated secondary minerals



**Figure 18.7 Humidity cells that remained acidic or near neutral, showing leachate pH and rates of copper and zinc leaching.**



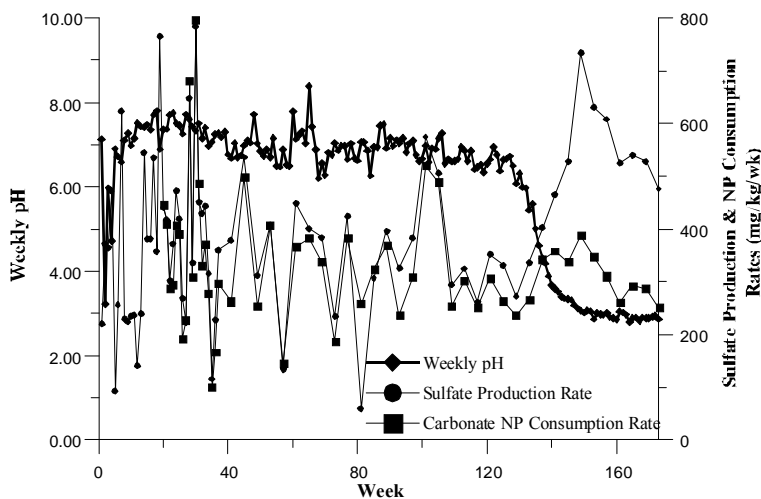
Pre-Test Data:

Crushed pH = 8.9 % S (Sulfide) = 3.13 Sobek-NP (tonnes CaCO<sub>3</sub> / 1000 tonnes) = 9

Remaining After Week 60:

% S (Sulfide) = 2.97 Sobek-NP (tonnes CaCO<sub>3</sub> / 1000 tonnes) = 7

- a) waste rock; sulphate rate exceeded NP rate from start; acidic conditions after Week 15; sulphate rate accelerated below pH 4; relatively constant NP rate of ~ 30 mg/kg/wk independent of pH; accidental addition of strong acid to cell at Week 34; unavailable NP ~ 8 t/1000 t



Pre-Test Data:

Crushed pH = 6.62 % S (Sulfide) = 12.20 Sobek-NP (tonnes CaCO<sub>3</sub> / 1000 tonnes) = 88

Remaining After Week 173:

% S (Sulfide) = 9.96 Sobek-NP (tonnes CaCO<sub>3</sub> / 1000 tonnes) = 26

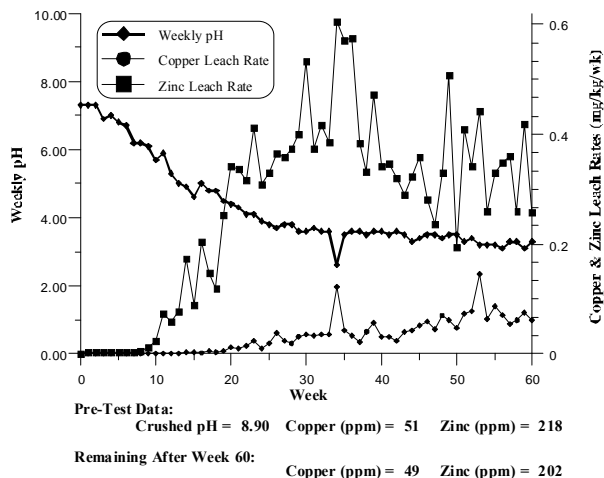
Post-Test Data:

% S (Sulfide) = 9.68 Sobek-NP (Tonnes CaCO<sub>3</sub> / 1000 tonnes) = 2

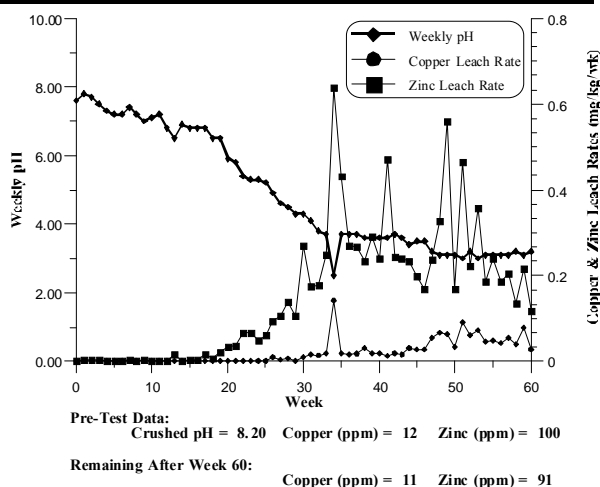
- b) tailings; pH initially acidic, then near neutral, then acidic around Week 135; sulphate and NP rates erratic but within defineable ranges; sulphate rate accelerated below pH 5; late NP rate steady despite onset of acidification; unavailable NP uncertain due to discrepancy between calculated remaining and post-test value, possibly attributable to erroneous pre-test analysis or neutralization by non-carbonate minerals

**Figure 18.8 Humidity cells that became acidic, showing leachate pH and rates of sulphate production (sulphide oxidation) and NP consumption.**

a) copper and zinc rates increase after Week 10 with pH<6; after Week 50, zinc generally steady within defineable range and copper increasing slightly; rates accelerated ~100x between start and end



b) copper and zinc rates increase after Week 20 with pH<6; after Week 55, copper and zinc generally steady within defineable ranges; rates accelerated ~50-100x between start and end



c) copper and zinc rates increase after Week 135 with pH<6 (note log scale for metal rates); copper and zinc decreasing at end; rates accelerated ~300-1000x between start and end

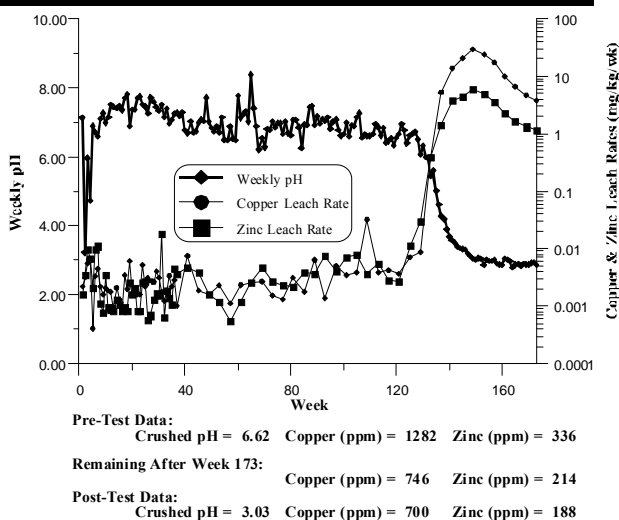


Figure 18.9 Humidity cells that became acidic, showing leachate pH and rates of copper and zinc leaching.

After a kinetic test is terminated, the closedown procedure (Section 18.2.6) should include a final rinse to determine the amount of accumulated soluble reaction products. Detectable retained weathering products can be redistributed evenly over all weeks of the test. This arbitrary practice is based on the assumption that the weekly amount of retained product was constant. As a result of this, all calculated weekly rates may increase after the termination of the test. If the weekly increase is significant, the sample was not properly prepared or was inadequately rinsed during the test (Section 18.2.5).

Humidity cell estimates of the relative rates of acidity production and NP consumption should be

*Humidity cell estimates of the relative rates of acidity production and NP consumption should be used to improve the ABA criteria for NPR.*

used to improve the estimates of the likelihood of ARD based on the ABA criteria for NPR (Chapter 14). For example, if kinetic tests produce a stable molar ratio of 1.75 NP:AP consumption at non-acidic

pH, then all samples with NPR values less than 1.75 should be considered net acid generating (Table 18.2). This assumption should include the qualifier “if the current rates and presently available NP persist”. However, the only way to reliably evaluate this assumption is to continue cell testing. For both preliminary and final interpretations, the percentage of rock units or mine components falling into each ARD category should be reported.

**Table 18.2 Final criteria for interpreting crushed/rinse pH and NPR**

Criteria	Prediction/Current Condition
<b>Crushed/Rinse pH</b>	
crushed/rinse pH < 6.0	currently acidic; future unknown
crushed/rinse pH = 6.0-8.0	currently near-neutral; future unknown
<b>x NPR</b>	
NPR < site specific criterion <sup>1</sup>	eventually acidic
NPR ≥ site specific criterion <sup>1</sup>	indefinitely near-neutral or alkaline
<sup>1</sup> “site-specific criterion” is the molar ratio of the rates of acid generation and acid neutralization for a unit or component obtained from laboratory and field kinetic tests which defines the minimum NPR value needed to maintain non-acidic conditions.	

#### 18.4 References

Day, S. 1994. Long-term Kinetic Acid Generation Studies: Cinola Project, British Columbia. Mine Environment Neutral Drainage Program. Report 1.19.1.

Sobek, A.A., W.A. Schuller, J.R. Freeman and R.M. Smith. 1978. Field and Laboratory Methods Applicable to Overburdens and Minesoils. Report EPA-600/2-78-054, U.S. National Technical Information Report PB-280 495.



## 19.0 KINETIC TESTS THAT MEASURE PRIMARY MINERAL WEATHERING AND SECONDARY MINERAL PRECIPITATION AND DISSOLUTION

### *Some Important Points in this Chapter*

*Drainage chemistry depends on both the primary mineral reactions (Chapter 18) and the precipitation and dissolution of the resulting secondary minerals. This chapter discusses several kinetic tests that examine both primary and secondary aspects at the same time and thus provide more direct predictions of drainage chemistry. These tests are: trickle leach columns (both subaerial and subaqueous types); field test cells, including leach pads and barrels; MEND wall washing stations; full-scale monitoring data; and previously weathered materials like outcrops or old rock piles. However, large disparities may exist among these tests and full-scale project components due to differences in sample preparation, site climatic conditions, sample size, scale and particle size. Even without these disparities, the equilibrium solubility processes and reaction product retention that play significant roles in determining drainage chemistry cannot always be reliably identified, even after decades of monitoring or testing.*

### 19.1 Introduction

Future drainage chemistry will depend on changes to the physical and chemical properties of the solid phase (e.g. mineral weathering) and drainage (e.g. decrease in pH) as a result of sulphide oxidation, other primary mineral reactions, and the precipitation and dissolution of the resulting secondary minerals (Figure 19.1). Some information on future changes to the solid phase and leachate can be derived solely from static test analyses of the existing composition (Chapters 10 to 17) or from primary mineral reaction rates (Chapter 18). However, the determination of the sometimes important effects of secondary minerals on drainage chemistry may require separate kinetic testing.

*Drainage chemistry depends on both the primary mineral reactions and the precipitation and dissolution of the resulting secondary minerals.*

Sulphides and Other Minerals  
 ↓ Oxidation, Other Weathering Reactions, Mineral Precipitation  
 Secondary Minerals  
 ↓ Leaching, Dissolution  
 Drainage Chemistry

**Figure 19.1 The relationship between sulphidic geologic materials, weathering over time and future drainage chemistry.**

### 19.1.1 Selection of Tests and Interpretation of the Results

Test selection should be based on the prediction questions, the predicted weathering and leaching conditions, and the properties being tested. Potential sources of kinetic data on the relationship between primary and secondary mineral weathering and dissolution include the following:

- laboratory trickle leach columns;
- wall washing stations;
- field test cells;
- full-scale project components; and
- natural non-lithified surficial material (e.g. talus) and outcrops, or other older disturbed materials.

Factors to consider in test selection and interpreting or reviewing the results include:

- whether the test occurs in the laboratory, at the mine site or at some other site. Site specific conditions may play an important role in many aspects of weathering and leaching;
- the scale of the test - full or reduced. A reduction in size may alter potentially influential factors such as the conservation of heat and the heterogeneity of drainage;
- differences in weathering and leaching conditions, and inputs and how this may alter weathering properties and processes; and
- whether the measurement objective is the drainage chemistry or the rate of primary mineral weathering. Measurement of primary mineral weathering requires an action to remove the solubility constraints. Usually this is accomplished with aggressive leaching or flushing that limits secondary mineral precipitation (Chapter 18). Measurement of drainage chemistry and primary mineral weathering are often mutually exclusive.

Large disparities may exist between laboratory kinetic tests and conditions of full-scale project components at a mine site due to differences in sample preparation, site climate conditions, sample size, scale and, in the case of waste rock, particle size. A synopsis of the test conditions for various common kinetic tests is shown in Table 9.3. A comparison of the different procedures is provided in the subsequent sections.

Under small-scale conditions, the recommended laboratory procedure for measuring drainage

*Under small-scale conditions, the recommended laboratory procedure is a trickle leach column.*

chemistry, contaminant loadings, changes in geochemical properties, and time to net acidic conditions is a trickle leach column.

Field based procedures for measuring drainage chemistry, contaminant loadings, changes in geochemical properties and time to net acidic conditions are field test cells, wall washing stations, and the monitoring of the actual dumps, pits, impoundments or underground workings.

### 19.1.2 Design of the Test

Design of the test, including the properties, frequency and locations to monitor, will depend on the:

- prediction objectives or questions;
- properties of the materials;
- existing information;



- timing of management actions and regulatory decisions;
- variability of the targeted properties and processes; and
- accuracy and precision required.

Information requirements in any kinetic test include the following:

- detailed pre-test characterization of the geologic materials and project components under investigation (Chapters 6 and 7);
- detailed pre-test characterization of the test material requiring comprehensive static testing (Chapters 10 to 17);
- operational monitoring during the test of drainage, weathering and leaching conditions, and reaction rates and changes in the test material; and
- post-test characterization of the test material, requiring comprehensive static testing (Chapters 10 to 17).

A more detailed discussion of each of the information requirements listed above is provided in Chapter 9.

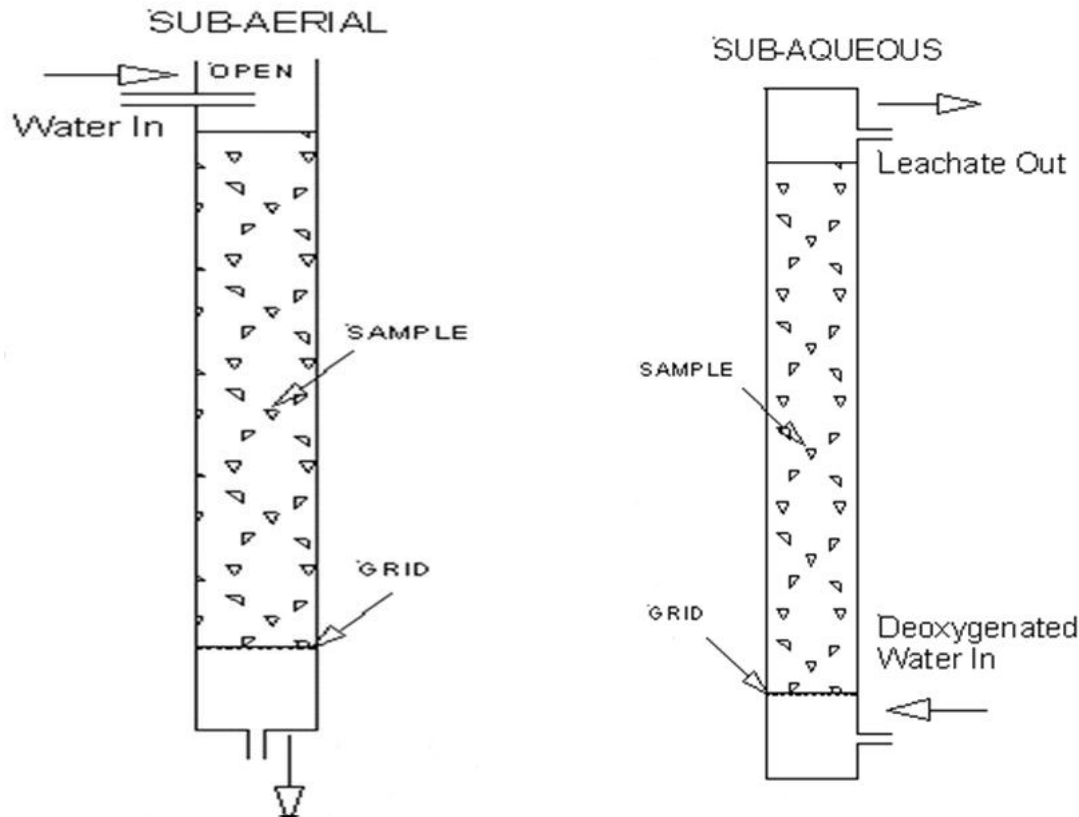
The monitoring objectives of kinetic tests that measure the net effect of both primary mineral weathering and secondary mineral precipitation and dissolution include measurement of:

- drainage chemistry of the discharge;
- flow, volume and location of the discharge;
- primary and secondary mineral weathering properties and processes;
- primary mineral depletion and secondary mineral precipitation; and
- site specific equilibrium mineral solubility limits.

## 19.2 Trickle Leach Columns

Trickle leach columns are laboratory procedures used to measure the impact of weathering and secondary mineral precipitation on drainage chemistry. One type, subaerial drip leach columns, can be used to predict the drainage chemistry from well drained materials (Figure 19.2a). Another type, subaqueous leach columns, can be used to predict drainage chemistry from materials that will be flooded (Figure 19.2b).

Where possible, column test procedures should match conditions in the field, such as drainage chemistry and rate of leaching (e.g. pH of leachate). This is important for both subaerial and subaqueous columns. One note of caution with regards to subaqueous columns is that high flow rates through flooded wastes may result in large inputs of dissolved oxygen. This can result in much higher rates of sulphide oxidation than those observed under field conditions where oxygen inputs are limited by diffusion from the overlying water cover.



**Figure 19.2a and 19.2b. Schematic diagrams of subaerial drip leach and subaqueous leach columns.**

Laboratory test results will be empowered where it can be shown that they are correlated with field rates, or that the test accurately simulates the rate and balances among important processes, such as oxidation, dissolution and entrainment. Where possible, the design of trickle leach tests should be modified to simulate key aspects of the weathering and leaching conditions, such as the redox potential, drainage pH and the leaching rate ( $\text{m}^3/\text{kg}/\text{yr}$ ) and residence time.

Space constraints that limit column size may result in a higher water:solid ratio than that of large dumps and impoundments. A higher water:solid ratio may reduce contaminant concentrations in drainage below the equilibrium solubility constraints that precipitate secondary minerals and control drainage chemistry and loadings in large scale mine components. Where reaching mineral equilibrium solubility constraints is a concern, drainage discharge from columns can be recirculated to effectively decrease the long-term water:solid ratio.

*Column effluent can be recirculated through a column several times, to effectively decrease the water:solid ratio and eventually attain equilibrium levels.*

The interpretation of the results of laboratory trickle leach columns should consider potential differences in weathering conditions between field and laboratory conditions. Significant differences in temperatures between the laboratory and the site may substantially change the rates of reactions such as sulphide oxidation. However, since sulphide oxidation is an exothermic reaction (produces heat), even in very cold climates, local temperatures at which the

geologic material oxidize may be far higher than the ambient air temperature. Local temperatures will depend on many factors, including rate of oxidation, heat loss and seasonal variation in ambient air temperatures.

It is important that the column design allows measurement of properties of interest. Analysis of drainage chemistry parameters should be sufficiently comprehensive to permit modeling (Chapter 20). It is also important to consider the timing of test results versus the timing of management or regulatory decisions. Geochemical changes can take decades and tests may need to run for a long time before conditions of interest occur.

Like other kinetic tests, column studies must include measurement of the composition of test material test prior to, and after, kinetic testing. Composition will indicate:

- whether samples are representative of the materials of concern;
- potential sources of solutes in drainage;
- time to desired performance (e.g. time to onset of acidic conditions); and
- which weathering products were not being leached.

Since the discharge drainage chemistry may not indicate internal weathering changes, columns

*Columns should be constructed from clear plastic tubing to allow weathering colour changes to be observed and include sampling ports to allow detection of internal changes in drainage chemistry.*

should be constructed from clear plastic tubing to allow weathering colour changes to be observed and include sampling ports to allow detection of internal changes in

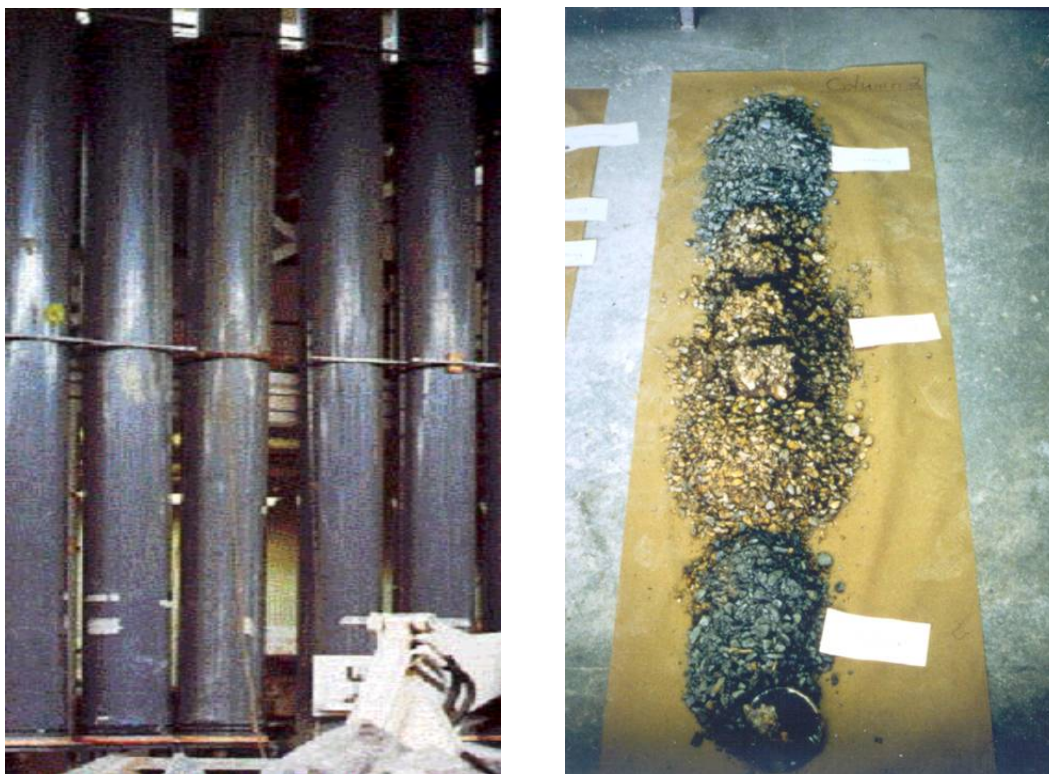
drainage chemistry (Figures 19.3a and 19.3b). Columns constructed from clear plastic should be run in a dark room, or covered up, to prevent algae growth.

The following column design (Figure 19.4) and much of the protocol came from Dr. Nand Davé of Natural Resources Canada (personal communication).

The protocol for various aspects of column start-up and operation is listed below.

#### Loading column with test material:

1. Place a circular disc of filter fabric with a diameter slightly larger than the inside diameter of the test column at the bottom of the column, ensuring there are no wrinkles or gaps between it and the column wall or bottom.
2. Gently place polypropylene filter beads on the bottom filter to a height of about 5 cm. Level the bead surface evenly.
3. Place a second filter disc on top of the filter-bead bed, smooth it out leaving no wrinkles or gaps between the filter and the column wall.
4. For each test column, prepare an equal mass of test material.
5. Gently place the test material in the column on top of the second filter disc, taking care to avoid disturbing the filter bed.
6. Close the bottom drain valve of the test column. Install a u-tube in the bottom drainage line to provide a water seal to prevent air entry from the bottom of the column.
7. Use appropriate sized spacers to provide a small aeration gap between the top of the column and its lid.



**Figure 19.3a and 19.3b. The chemistry of the column discharge may not indicate internal changes to weathering conditions.**

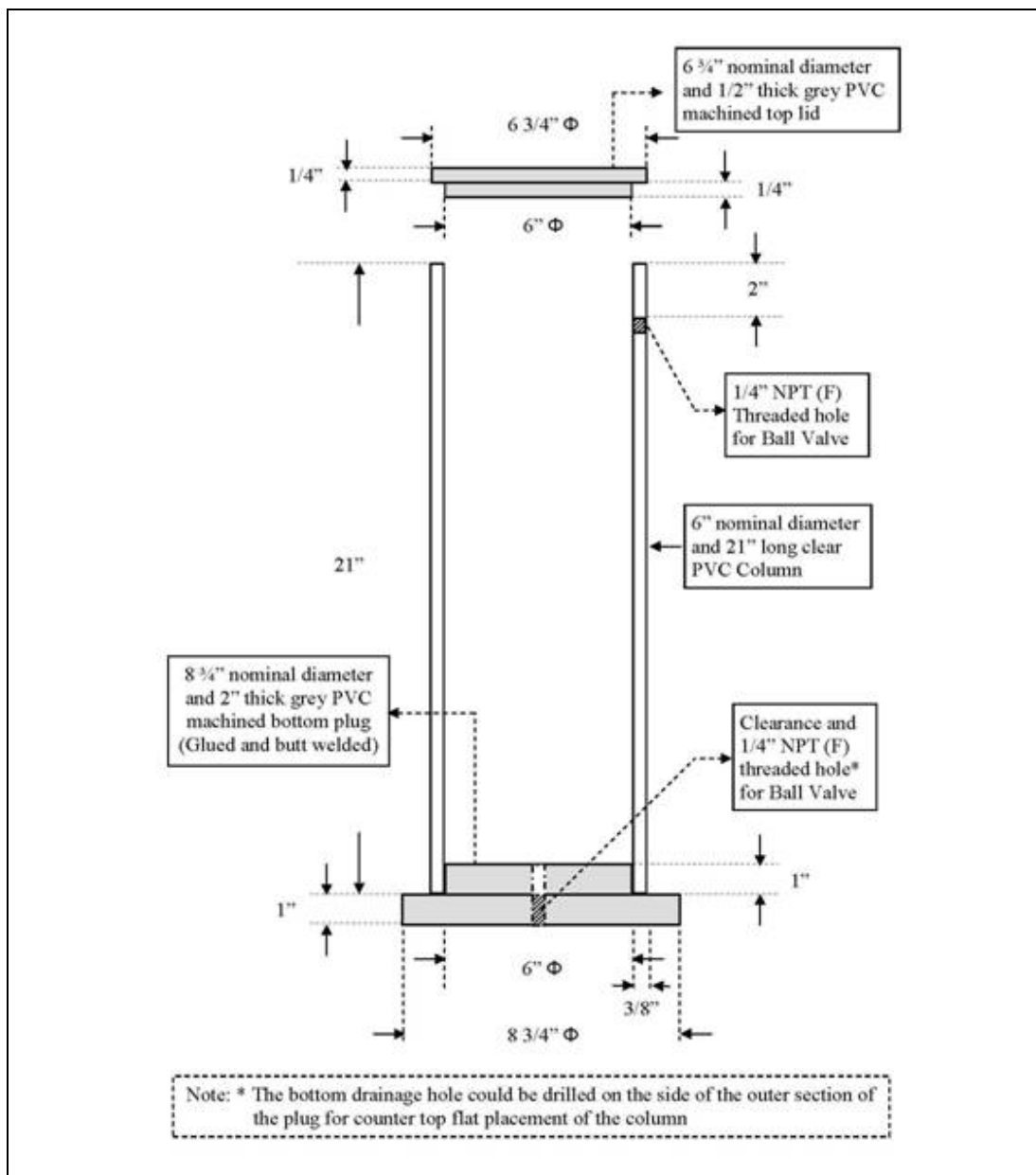
Preparation of drill core for use as the test material:

1. Crush the drill core to a nominal particle size of ~6 mm (1/4"). Homogenize the crushed waste rock sample and take appropriate head samples for analysis.
2. The mass of test material in each column will be determined by the smallest core sample available per duplicate column per waste rock group that is being tested.
3. Prior to loading, take a sub-sample of each test material for pre-test analysis of the composition of the < 2 mm and > 2 mm fractions.

Column operation and test procedures:

1. Drainage can be added by drip leaching, or by gently spraying the surface of the test material with site precipitation, simulated rain or deionized water. The rate, manner and frequency of drainage input should be based on site specific climate and hydrogeologic conditions.
2. Obtain regular samples of the input water for analysis of a control sample.
3. Obtain an in-line drainage sample to measure the following primary water quality parameters: dissolved oxygen (DO), temperature, pH, oxidation reduction potential (ORP or Eh) and electrical conductance (EC).
4. Measure the volume of the collected drainage effluent.
5. Filter the control and a composite sample of the collected drainage effluent with 0.45 µm membrane filters and analyze for water quality parameters.
6. Continue until termination of the experiment.

7. Upon termination of the experiment, obtain appropriate post-leaching samples from surface and sub-surface sections of the test material. This procedure may require freezing of the column and cutting of the frozen core to obtain appropriate sectional samples.



**Figure 19.4 An example of a column design.**  
(from Nand Davé, Natural Resources Canada)

## 19.3 Field Test Cells

### 19.3.1 Introduction

On-site field test cells are field tools for measuring primary mineral weathering and secondary mineral precipitation and dissolution. Operating mines should construct on-site field cells, and wall washing stations (Section 19.4) for each combination of project component and geologic material that is of importance with respect to drainage chemistry.

*On-site field test cells are field tools for measuring primary mineral weathering and secondary mineral precipitation and dissolution.*

Test design characteristics of field test cells include:

- measured mass, dimensions and lateral surface area;
- particle size distribution and particle surface area;
- measured physical and geochemical composition;
- isolation from inflowing runoff and groundwater where appropriate, with incident precipitation as the primary input;
- all discharge collected, with the rate and the volume recorded; and
- natural on-site climate conditions of temperature, humidity, and precipitation, whose values are measured and recorded on a regular basis.

Regular collection of drainage, and inspection and maintenance are important considerations to ensure that all drainage is collected. For example, after a significant rainfall and after flow from the test ceases, collect the drainage and, determine the water volume and process the water for chemical analysis (filter, preserve, etc.). Lateral area and rates of incident precipitation are needed to calculate the rate of water input for comparison to drainage collection. Mass and particle size are needed to estimate the particle surface area, a portion of which contributes to the chemistry of the collected drainage.

Some disadvantages of field test cells include:

- some potential heterogeneity in composition and flow paths;
- irregular, incomplete flushing which could allow accumulation of soluble secondary weathering products and thus permit measurement of resulting drainage chemistry while precluding measurement of primary reaction rates;
- irregular seepage which could affect sample collection; and
- edge effects, including limited conservation of heat generated by oxidation.

A smaller sized field test permits more detailed characterization than a full-scale project component. The smaller size and well-characterized test material will permit measurements of drainage chemistry to be made for a known composition and volume/mass of material. A heterogeneous waste rock dump cannot be characterized as accurately, and it is impossible to tell what portion of the composition contributes to the drainage chemistry of the discharge. However, drainage chemistry can sometimes be affected by scale, so smaller scale field test cells are not always representative of full-scale components.

The behaviour of field tests depends on the volume of rock and the amount of precipitation.

*The behaviour of field tests depends on the volume of rock and the amount of precipitation. With extremely high precipitation, field test cells can behave like humidity cells.*

With extremely high precipitation or artificial leaching, field test cells can behave like humidity cells where there is almost complete rinsing of relatively soluble reaction products (Chapter 18).

On the other hand, higher volumes of rock, or proportionally less precipitation, can lead to significant geochemical retention more typical of full-scale behaviour.

Field test cells may be constructed from various materials and with different designs. Examples include:

- piles of waste material placed on plastic pads (Figure 19.5) or in lined trenches; and
- waste material placed in clean, large containers that are open on top, and fitted with a basal drain hole (Figure 19.6).

The mass of material that could be used includes plastic 220-L barrels capable of holding about 500 kg, portable drilling mud tanks that could hold about 2 tonnes, V-shaped trenches lined with geotextile capable of holding 20 t and above ground wooden cribs capable of holding over 100 t.

Interpretation of the results is discussed in Section 19.6.

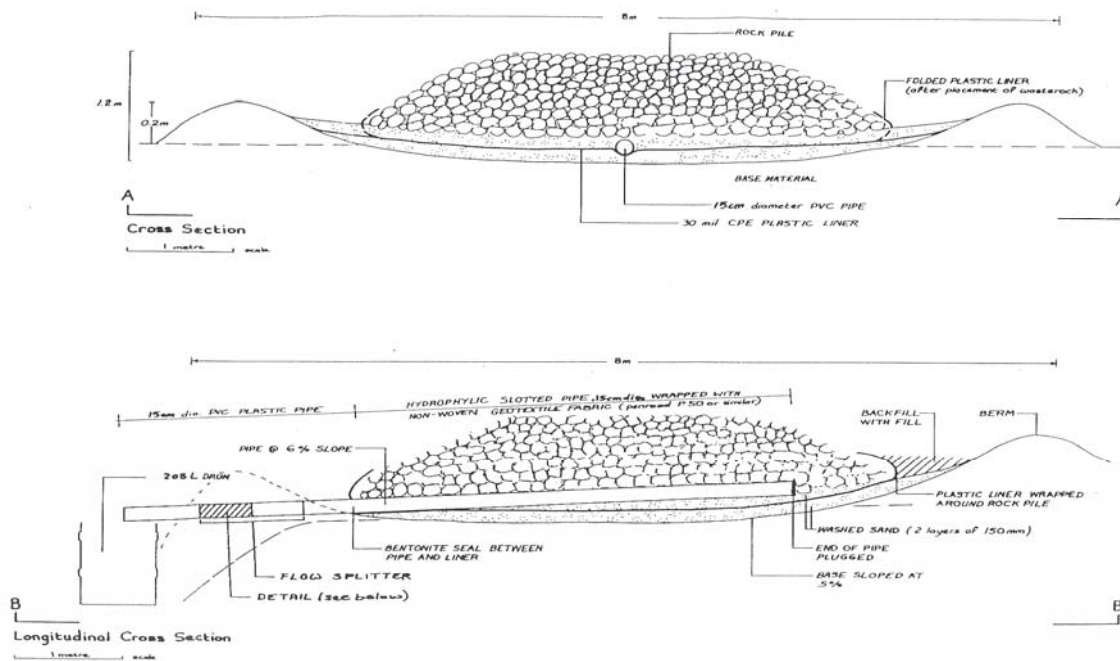


Figure 19.5 Field test pads built on a plastic liner (Day, 1994).





**Figure 19.6** Field test pads built in a lined wooden box.

### **19.3.2 Procedure for On-Site Kinetic Tests using Barrels or “Cubes”**

One design and operating protocol involves 220 L plastic barrels or 1 m<sup>3</sup> metal bar reinforced plastic “cubes” with basal drainage assemblies (K. Morin, personal communication).

#### Construction and Assembly

1. Deliver to the site the required number of 220 L plastic drums (barrels) or 1 m<sup>3</sup> plastic “cubes” with metal cage supports. If the tops are sealed on, or are continuous with the sides, cut the tops off.
2. Along the side, near the base but not at the very bottom, drill or cut a 5 cm (2-inch) diameter hole; this is easily done with a 5 cm (2-inch) diameter door knob drill bit. Note: The space left above the bottom allows some water to remain in the barrel or cube that serves as a supply of humidity, and makes installation of the flange easier.
3. Install a threaded flange through the 5 cm (2-inch) hole. Seal the inside and outside rims with pure silicon sealant as the two pieces of the flange are screwed together. The outside of the flange must end with a female coupling for 5 cm (2inch) diameter pipe (ABS or PVC) and must be the same type of plastic as the pipe.
4. Cover the inside opening of the flange with a steel screen, with openings of approximately 1.3 cm (1/2 inch) square. Secure the screen to the inside lip of the flange by bending the screen around the flange or by using tape or sealant. Place some fill around and over the screen and flange, to protect it during the filling process.
5. Fill the barrel or cube, periodically collecting representative sub-samples of material for solid phase analyses, such as Acid Base Accounting.



6. Glue 5 cm (2inch) diameter pipe (ABS or PVC) to the outer opening of the flange.
7. Cut a vertical slot from the top of the collection bucket. Cut down about 7.5 cm (3 inches) and about 7.5 cm (3 inches) wide and remove the resulting plastic strip from the bucket.
8. Create a base for the bucket from soil, lumber, etc., so that the bucket can be slid laterally onto and off the pipe without disturbing the pipe; this simplifies periodic collection of water.
9. Place the lid on the collection bucket and secure it, so that wind and other disturbances will not move the lid or bucket.
10. Calculate and record the volume of material added, as well as the lateral cross sectional area of the open top.

#### Periodic Collection of Water Samples

1. Gently slide the bucket laterally away from the drainage pipe.
2. Gently remove the lid.
3. Record the volume of water in the bucket, and note if the bucket was full. (Comment: This information will be required in a later step.)
4. Collect water quality samples according to standard protocols.
5. Empty the bucket; gently slide laterally so that the end of the drainage pipe is inside the vertical slot in the bucket.

#### On Site Field Data Form

1. Project
2. Leach Pad ID
3. Date / Time / Weather
4. Sampling personnel
5. Diameter of bucket (1st time only)
6. Lateral area of pad (1st time only)

#### Field Measurements

1. Volume of water in bucket
2. Water overtopped bucket? Yes / No
3. pH, conductivity and temperature

#### Sample Collection

1. General parameters (analyze for TDS, TSS, pH, conductivity, alkalinity, acidity, nitrate, nitrite, ammonia, anions)
2. Total Metals
3. Dissolved Metals Field Filtered? Yes / No

#### Maintenance

1. Depth of sediment in bucket (cm)
2. Bucket emptied and rinsed with dilute HNO<sub>3</sub> and/or distilled water
3. Bucket covered (but not sealed)

Note: Make observations concerning the test, including any change in the colour of the rock.

## 19.4 Wall Washing Stations

The MEND Minewall Procedure for using wall washing stations was developed in British Columbia for the B.C. AMD Task Force and the Canadian MEND Program (Morwijk Enterprises, 1995; Morin and Hutt, 2006). It has been used in British Columbia at Bell Mine, Island Copper Mine, Equity Silver Mine, Mt. Washington, the Tulsequah Chief Project, as well as at sites in Mexico, the USA, Indonesia and the Caribbean. Limitations of the procedure include the difficulties of setting up wall washing stations on fractured rock, especially in active mines, and in estimating the source area contribution of unseen fractures that cannot be sealed or avoided. Practitioners must therefore determine whether the sampling sites are representative of the weathering conditions in locations which cannot be tested.

*The MEND Minewall Procedure for wall washing stations, based on studies from the 1960's, has been used in Canada, Mexico, the USA, Indonesia and the Caribbean.*

Small fractures may be sealed to prevent water loss or ingress, but highly broken or non-lithified walls may not be suitable for this technique. One possible means for collecting information from highly fractured and non-lithified walls is with complementary humidity cell testing of rock chips (Chapter 18). Alternatively, an approximate surface area correction may be applied to humidity cell results (Morin and Hutt, 2006).

Further details on the wall washing stations and the procedure for data analysis and interpretation may be obtained from the Minewall documentation (Morwijk, 1995). This procedure provides information that may not be obtained from other kinetic tests. As with any procedure, its strengths and weaknesses will become clearer with time. Presently, as with most kinetic tests, this one provides a useful order of magnitude calculation of the contributions from possible contaminant sources.

### Equipment (for each station)

1. 3 m of 90°-bent, flexible plastic bathtub edging.
2. 2 tubes of pure silicon bathroom sealant (must be pure silicon).
3. 1 sheet of clear plastic ~1 m by 1 m.
4. 8 black metal clasps (often used for holding unbound reports).
5. 1 L of distilled water in a squeeze bottle which allows the direction and pressure of the water to be controlled.

### Installation Procedure (see Figure 19.7)

1. Select a relatively flat surface of rock, preferably with no surface fractures, and measuring no larger than 1 m by 1 m.
2. Mark the intended perimeter of the station on the surface with a pencil, with three, four, or five limbs.
3. The lowest, or bottom limb, must slope downwards from horizontal so that all water caught on it will drain in one direction for collection and later analysis.
4. Cut the plastic edging to the length required for each limb.
5. Install each limb, using pure silicon sealant as the glue.
6. Ensure the silicon sealant fills all open spaces between the edging and the rock surface so that no water can pass through.

7. Ensure that each limb overlaps, so that no gaps exist at any junction.
8. Ensure that the upper limb(s) will divert water around the sides of the station so that wall runoff will not flow over the isolated area of the station.
9. With 1 L of distilled water, wash the entire isolated surface within the edging, rinsing out any loose rock/dust and ensuring all water is caught by the edging and directed to the bottom limb where the water can then be caught in a bottle.
10. Cut the clear plastic sheet to extend 2 cm over each limb, then loosely attach the plastic sheet with the metal clasps, ensuring the plastic sheet does not touch the rock surface but prevents all precipitation and runoff from reaching the isolated rock surface.

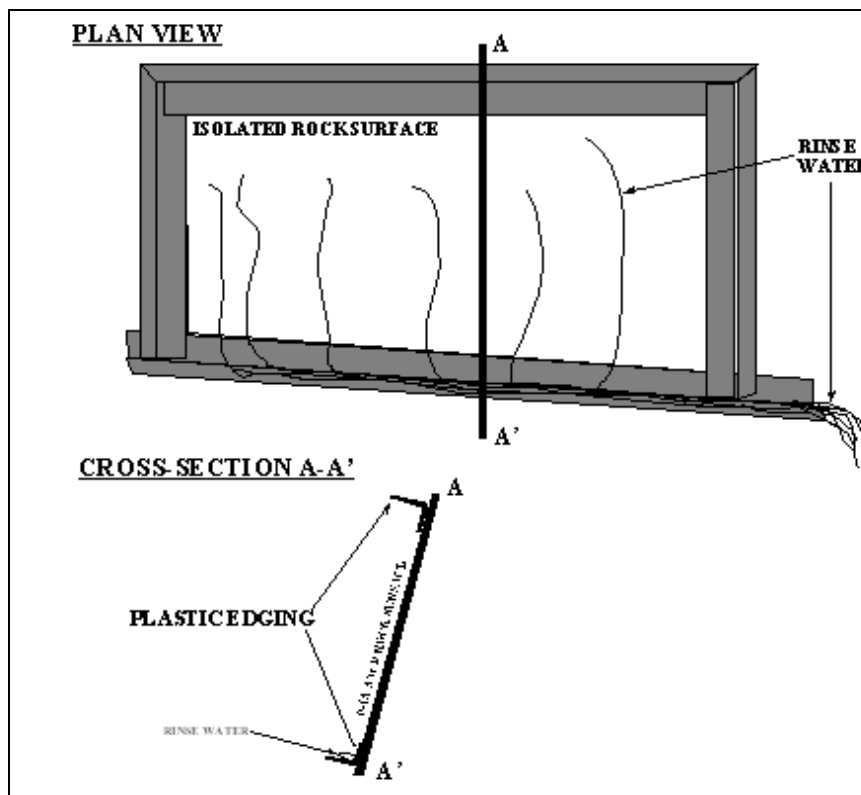


Figure 19.7 Diagram of Minewall station assembly.

### Regular Sampling

1. Carefully remove the plastic sheet and place it in a clean and dry location.
2. Inspect the station for loose edging and broken seals against the rock; repair any problems AFTER sampling (below), but avoid losing rinse water through any broken seals.
3. Record a note if there is any condensation, and if any water may have condensed and trickled out of the station between sampling events.
4. Place a calibrated collection bottle at the downstream (outflow) end of the lower limb (trough) to catch all subsequent rinse water.
5. With a calibrated squeeze bottle, spray at least 200 mL onto the isolated rock surface to rinse the entire area thoroughly; use as little water as possible; it is important to catch all

- rinse water in the collection bottle but not to overly dilute the rinsed reaction products; record the volume of water sprayed on the rock.
6. Record the amount of water recovered in the collection bottle.
  7. Analyze the water in the collection bottle like any other water sample. Measurement should include pH, acidity, alkalinity, sulphate, dissolved metals and total metals as desired.
  8. As a quality assurance procedure, for one round of sampling also filter a similar volume of the distilled water through a 0.45  $\mu\text{m}$  filter, then analyze as is done with other water samples.

Interpretations of mine wall stations parallel those of humidity cells (Chapter 18), but rates are reported as  $\text{mg}/\text{m}^2/\text{wk}$ , rather than  $\text{mg}/\text{kg}/\text{wk}$ .

### 19.5 On-Site Monitoring of Mine Components and the Resulting Drainage

On-site monitoring (Figure 19.8) can provide very useful predictive information about:

- the range of weathering;
- drainage chemistry under different geochemical conditions;
- trends in metal leaching over time;
- solubility constraints;
- fine particle replenishment; and
- the correlation of contaminants with diagnostic drainage parameters.

Accumulated operational drainage monitoring data collected over the life of a mine is often one of the main sources of prediction data consulted in the review of closure plans. Analysis of the pore water and drainage discharged from project components may provide valuable site specific measurements of leachable constituents, the resulting drainage chemistry and solubility limits. Comprehensive monitoring of the pore water and drainage may be conducted to check previous predictions and to track changes in drainage chemistry.

*Accumulated operational drainage monitoring data, another type of field kinetic test, is often one of the main sources of prediction data consulted in the review of closure plans.*

The main advantage in field monitoring is that the measurements are of “real” weathering and drainage, whereas pilot scale and smaller testing may preclude potentially significant factors such as the:

- conservation of heat generated by oxidation in acidic dumps;
- insulation from external temperature variations;
- particle size segregation; and
- drainage heterogeneity.



**Figure 19.8 On-site monitoring can provide very useful prediction information.**

The primary disadvantages in field monitoring are that:

- the data are not available in advance of the project construction;
- the diagnostic ability is usually limited to the existing geochemical conditions;
- the source of drainage may be too large to accurately characterize and it is often difficult to determine what portion of the whole has contributed to, or is represented by, the results;
- separating additional uncontrolled factors, such as the contribution of off-site groundwater discharge which can distort the results, may not be possible; and
- natural conditions, such as the wide particle size distribution of waste rock and the irregularity of natural weather conditions, air temperature, humidity, precipitation rate and quality, introduce variability that may be very costly to remove or impossible to account for.

There are several important features to consider in analysis of field monitoring results.

- There may be more than one source of drainage, sometimes resulting in variable waste flushing and irregular dilution. Although, all drainage sources should be identified prior to analysis, some uncertainty may remain.
- One of the most difficult tasks in waste analysis is estimating what portion of the whole a particular sample or analytical result represents. Given the complexity, the contributing materials will rarely be completely characterized.
- Flow paths through mine wastes are uncertain. Therefore, there is some uncertainty regarding which portion of the whole contributed to the drainage chemistry.
- Irregular, incomplete flushing will result in the irregular accumulation of soluble secondary weathering products.
- Irregular leaching may impede drainage collection.

Several valuable observations on the range in contaminant concentration, the regularity of annual chemical cycles, and the application of humidity cells for predictions have been gained from the drainage monitoring at Bell and Island Copper Mines in British Columbia with up to 25 years of drainage monitoring results (Morin et. al. 1995a, 1995b; Morin, 1994; Morin and Hutt, 1993). All drainage chemistry data should be regularly compiled into spreadsheets and periodically examined for trends and revisions of predictions.

In addition to drainage monitoring, periodic sampling and analysis is required to characterize the form and rate of weathering in the solid phase of tailings, waste rock and mine walls. This ongoing analysis of the solid phase verifies pre-mining predictions of the form and rate of weathering. When the composition is similar to that of wastes from new mines, field evidence from historic mine sites may provide a prognostic tool for new mining developments.

*Periodic sampling and analysis is required to characterize the form and rate of weathering in the solid phase of tailings, waste rock and mine walls.*

Due to complexities and confounding features such as geochemical retention, various drainage sources and material heterogeneity (Chapters 5, 6 and 7), site monitoring results should be interpreted with caution, and with the assistance of data from smaller scale tests on more completely characterized materials (Chapter 18 and Section 19.2). Field monitoring and humidity cell results have been shown to be similar at several sites once weathering product retention is taken into account (Morin and Hutt, 1997).

## 19.6 Interpretation Results from On-Site Kinetic Data

Excavated mine wastes, exposed walls and field test pads are intermittently and incompletely leached, resulting in at least some retention of the products of primary mineral weathering. As a result, equilibrium solubility processes and reaction product retention (e.g. Table 19.1) will play significant roles in determining the chemistry of drainage from full-scale components and smaller scale on-site kinetic tests.

*Equilibrium solubility processes and reaction-product retention will play significant roles in determining the chemistry of drainage from full-scale components and smaller scale on-site kinetic tests.*

Scatterplots showing changes in the data over time, and geochemical speciation models such as MINTeq (Chapter 20), can be used to identify trends and to assist in identifying equilibrium conditions (e.g. Table 19.2). While it is often a powerful tool, speciation modeling will not always be capable of explaining the observed mine site geochemistry.

Studies have shown evidence of equilibrium processes that operated for decades, while modeling of the data failed to identify the mineral causing equilibrium (Morin and Hutt, 1997 and 2007). Modeling predictions regarding equilibrium solubility conditions should be interpreted with caution, and wherever possible the conclusions should be supported by long term monitoring of water chemistry.

*Studies have shown evidence of equilibrium processes which operated for decades, while modeling of the data failed to identify the mineral causing equilibrium.*

**Table 19.1 A comparison between humidity cell and field test pad results can indicate the proportional retention of weathering products.**

Parameter	Acidic Conditions			pH-Neutral Conditions		
	Cell Rate <sup>1</sup>	Field Rate <sup>2</sup>	Retention <sup>3</sup>	Cell Rate <sup>1</sup>	Field Rate <sup>2</sup>	Retention <sup>3</sup>
pH <sup>4</sup>	2.90	2.6-4.5		7.08	6.3-7.5	
Acidity	231	0.318	99.86	0.92	0.00811	99.12
SO <sub>4</sub>	575	1.74	99.70	12.2	0.188	98.46
Ca	8.81	0.144	98.37	5.0	0.0919	98.16
Cd	0.00134	0.000169	94.62	9.60e-05	7.65e-07	99.20
Cu	0.0793	0.00894	88.73	1.90e-03	1.31e-05	99.31
Ni	0.0161	0.000300	98.14	7.20e-04	8.23e-07	99.89
Pb	0.0127	0.000143	98.87	8.70e-04	5.14e-07	99.94
Zn	0.214	0.0351	83.60	4.50e-03	4.33e-05	99.04

<sup>1</sup> From humidity cells (mg/kg/wk)  
<sup>2</sup> Average rates calculated from field test concentrations, water recovered, and weight (mg/kg/wk)  
<sup>3</sup> Retention Factor = {[Cell Rate - Field Rate]/Cell Rate}x100%  
<sup>4</sup> pH is presented in pH units and not as a rate

**Table 19.2 A comparison between drainage chemistry measured for a field test pad and the equilibrium limitation predicted with an empirical model at the Tulsequah Chief Project in British Columbia.**

Parameter	Acidic Range			pH Neutral Range		
	Field kinetic range <sup>1</sup>	Model value <sup>2</sup>	Control <sup>3</sup>	Field kinetic range <sup>1</sup>	Model value <sup>2</sup>	Control <sup>3</sup>
pH	2.6-4.5	2.7		6.2-7.5	7.0	
Acidity	420-965	1175		7-11	17	
SO <sub>4</sub>	1120-8800	2000	CaSO <sub>4</sub> ·2H <sub>2</sub> O; AlOHSO <sub>4</sub> (+0.5); jarosites?	130-250	225	KAl <sub>3</sub> (SO <sub>4</sub> ) <sub>2</sub> (OH) <sub>6</sub> (+0.4)
Ca	131-286	255	CaSO <sub>4</sub> ·2H <sub>2</sub> O	62-114	0.36	
Cd	0.11-0.80	0.58	mineral unidentified	0.0005-0.0011	<0.0001	CdCO <sub>3</sub> (-1.3)
Cu	4.0-5.2	27	mineral unidentified	0.0083-0.016	<0.0001	
Ni	0.069-0.74	1.58	mineral unidentified	0.00025-0.0018	<0.00001	
Pb	0.07-0.41	0.4	PbSO <sub>4</sub> (-1.5)	<0.0001-0.0016	0.004	PbAl <sub>3</sub> (PO <sub>4</sub> ) <sub>2</sub> (OH) <sub>5</sub> ·6H <sub>2</sub> O
Zn	23-162	78	mineral unidentified	0.008-0.050	<0.0001	

<sup>1</sup> From humidity cells (mg/kg/wk)  
<sup>2</sup> Average rates calculated from field test concentrations, water recovered, and weight (mg/kg/wk)  
<sup>3</sup> From MINTEQ results; values in parentheses reflect adjustments to general solubility values in MINTEQ

Two of the best examples of long term drainage monitoring are at the Island Copper Mine and Bell Mine in British Columbia. Compilations of water chemistry data from both sites have shown that, year after year, the elemental concentrations vary within definable ranges, for a particular range of pH (Chapter 20). This behaviour is consistent with equilibrium conditions. MINTEQA2 identified possible mineral equilibrium for cadmium and copper, but not for zinc, despite its equilibrium-like behaviour. The lack of an identified mineral for zinc probably reflects site specific factors and/or weaknesses in MINTEQA2 and other related programs.

### 19.7 Examining Previously Weathered Materials

In addition to formal kinetic tests, valuable information about site specific weathering conditions and how weathering will progress in mine wastes and walls can be obtained by examining previously weathered materials with similar geologic and geochemical properties and weathering and leaching conditions.

Previously weathered materials with similar geologic and geochemical properties and weathering and leaching conditions to mine wastes and walls may include:

- natural non-lithified surficial material;
- natural outcrops; and
- materials excavated during exploration or previous projects.

Materials excavated previously may provide information about a much longer period of

*Materials excavated previously may provide information about a much longer period of weathering than kinetic tests initiated in the current prediction program.*

weathering than kinetic tests initiated in the current prediction program. Prior to project development, previously weathered materials may be the only source

of site specific information about longer term weathering and leaching, and the resulting drainage chemistry. For example, weathering in piles of waste rock from an exploration adit may indicate the rate of depletion of carbonate minerals and whether net acidic conditions will develop within the period of exposure of the excavated rock types.

Difficulties encountered in using previously weathered materials to predict the drainage chemistry of new project components include:

- uncertainty regarding their initial composition;
- uncertainty regarding earlier drainage chemistry and stages of weathering; and
- differences in physical, atmospheric, drainage and geochemical properties, and processes.

A lack of information about the initial composition of the previously weathered material will

*A lack of information about the initial composition of the previously weathered material will make it difficult or impossible to calculate previous rates of mineral depletion.*

make it difficult or impossible to calculate previous rates of mineral depletion and to extrapolate measurements to materials with potentially different surface areas or concentrations of minerals.



The stage of weathering may have a large effect on drainage chemistry. The depletion of more reactive materials may reduce reaction rates and contaminant concentrations in very old natural outcrops and non-lithified surficial material compared to the maximum rates and concentrations from recently exposed mine wastes. Conversely, despite many years, even decades, of exposure, contaminant concentrations from materials excavated during exploration or previous projects may not yet have reached their maximum contaminant concentrations. Detailed characterization is required to assess whether contaminant release has past its peak. Even with detailed characterization, caution is also required when extrapolating results from a limited portion of the geology and areas proposed for mining to the entire range of geologic materials and site conditions.

Differences in physical and drainage conditions may result in different weathering rates and drainage chemistries for natural outcrops or non-lithified materials than for waste materials or walls with similar geochemical compositions. For example, the lower permeability in a rock outcrop may reduce the rate of sulphide oxidation sufficiently for drainage alkalinity or less reactive minerals to neutralize much or all of the acidity that is produced. Lower rates of sulphide exposure in naturally produced materials may result in lower rates of sulphide oxidation and contaminant release.

## 19.8 References

Day, S. 1994. Long-term Kinetic Acid Generation Studies: Cinola Project, British Columbia. Mine Environment Neutral Drainage Program. MEND Report 1.19.1.

Morin, K.A. 1994. Prediction of Water Chemistry in Open Pits during Operation and After Closure. In: Proceedings of the Eighteenth Annual British Columbia Mine Reclamation Symposium, Vernon, British Columbia, April 11-14.

Morin, K.A. and N.M. Hutt. 1993. The Use of Routine Monitoring Data for Assessment and Prediction of Water Chemistry. In: Proceedings of the 17th Annual British Columbia Mine Reclamation Symposium, Port Hardy, British Columbia, May 4-7. pp. 191-201.

Morin, K.A. and N.M. Hutt. 1997. Environmental Geochemistry of Minesite Drainage: Practical Theory and Case Studies. MDAG Publishing, Vancouver, British Columbia, Canada.

Morin, K.A. and N.M. Hutt. 2006. The MEND Minewall Technique: Overview and Details. In: Proceedings of 13<sup>th</sup> Annual British Columbia - MEND Metal Leaching/Acid Rock Drainage Workshop, Challenges with Open Pits and Underground Workings. Vancouver, British Columbia, November 29-30.

Morin, K.A. and N.M. Hutt. 2007. Scaling and Equilibrium Concentrations in Minesite-Drainage Chemistry. MDAG Internet Case Study #26, [www.mdag.com/case\\_studies/cs26.html](http://www.mdag.com/case_studies/cs26.html).

Morin, K.A., N.M. Hutt and I.A. Horne. 1995a. Prediction of Future Water Chemistry from Island Copper Mine's On-Land Dumps. In: Proceedings of the 19th Annual British Columbia Mine Reclamation Symposium, Dawson Creek, British Columbia, June 19-23. pp. 224-233.

Morin, K.A., N.M. Hutt and R. McArthur. 1995b. Statistical Assessment of Past Water Chemistry to Predict Future Chemistry at Noranda Minerals' Bell Mine. In: Proceedings of Sudbury 1995: Mining and the Environment Conference, Sudbury, Ontario, May 28 - June 1, Volume 3.

Morwijk Enterprises Ltd. 1995. MINEWALL 2.0. Series of four reports (User's Manual, Literature Review, Application of MINEWALL 2.0 to Three Minesites, and Programmer's Notes and Source Code). MEND Report 1.15.2.

## 20.0 MODELING DRAINAGE CHEMISTRY

### *Some Important Points in this Chapter*

*Drainage chemistry modeling can assist with the interpretation of test work and monitoring results and may improve the prediction of drainage chemistry and loadings. However, modeling cannot substitute for good site specific monitoring and understanding. Modeling predictions need to be tested before they can be accepted.*

*Brief overviews of three basic categories of drainage chemistry modeling are presented in this chapter: empirical modeling, speciation and mineral equilibrium modeling and complex models. If a minimum of hundreds of water analyses are available for a particular site, then these analyses can be compiled into a statistical “empirical drainage chemistry model” (EDCM). The speciation and mineral equilibrium model applies pre-selected chemical reactions, equilibrium constants and mineral solubilities to a particular water analysis to estimate aqueous concentrations of all pertinent chemical species and determine whether minerals are close to saturation. Complex models simulate more than just chemistry and can include water and gas-phase movement across an entire mine site.*

Water quality modeling using empirical, geochemical or complex models can assist with the interpretation of test work and monitoring results and may improve the prediction of drainage chemistry and loadings (Martin et al., 2005). Models may assist in the:

- comprehension of connections among project components, particularly the movement of sulphidic geologic materials and drainage;
- organization of data and calculation of derived parameters;
- speciation of dissolved and precipitated reaction products;
- prediction of mineral equilibrium solubility limits; and
- evaluation of different scenarios.

Potential weaknesses of models include assumptions regarding input parameters, a lack of site

*Models are tools to assist with the prediction of drainage chemistry and loadings, but cannot substitute for good, site specific measurements and understanding.*

specific data, and limited verification. Models are tools to assist with the prediction of drainage chemistry and loadings, but cannot substitute for good, site specific measurements and understanding. Modeling

predictions need to be validated before they can be accepted.

Where possible, modeling techniques and programs that are widely used and tested should be employed. Custom-made or in-house models that are unpublished, or are not widely released, require thorough explanation and justification and should be used with caution.

## 20.1 Empirical Modeling

Empirical modeling uses long term site specific monitoring data to predict future annual average and seasonally variable drainage chemistry.

Morin and Hutt (1993), Morin (1994) and Morin et al. (1995a; 1995b) reported that annual

*Empirical modeling uses long term site specific monitoring data to predict future annual average and seasonally variable drainage chemistry. At least hundreds of water analyses are needed to do this reliably.*

means and standard deviations of drainage chemistry at the Island Copper and Bell Mines were relatively constant provided pH remained at a similar value (Figure 20.1). Because the rate of sulphide oxidation at these sites generally exceeds the rate of product dissolution, the precipitation and

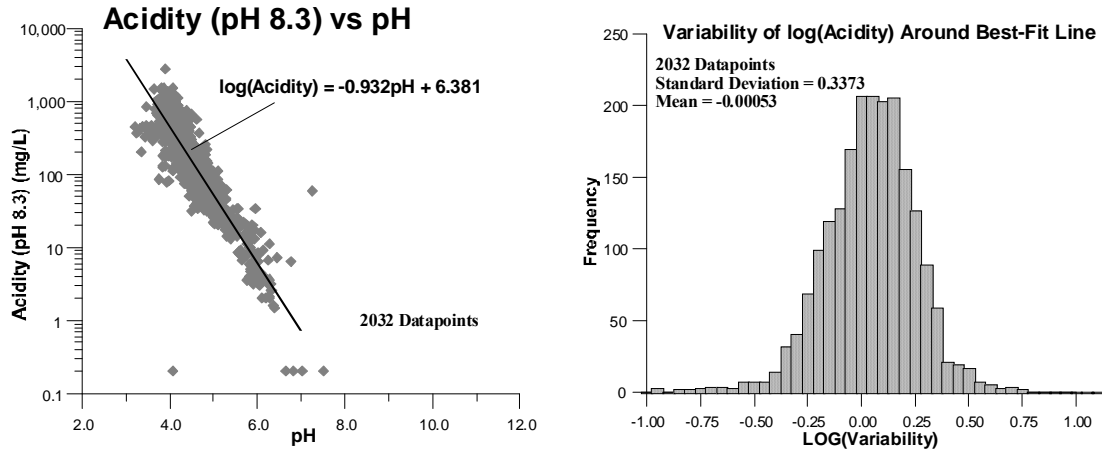
dissolution of many secondary minerals can be equilibrium controlled. Consequently, a relatively narrow range of concentrations at a particular pH can often be observed annually over years of monitoring and these concentrations are predictable. The prediction of the concentration ranges does not require the identification of the secondary minerals, although such identification may be possible (Section 20.2).

A compilation of best fit lines relating pH or another parameter to aqueous concentrations and the corresponding standard deviations is known as an “empirical drainage chemistry model” (EDCM, Table 20.1). It is important to note that this table shows that some parameters do not correlate well with pH. Instead, they can be relatively constant across the observed range of pH or correlate better with another parameter such as sulphate. Under the assumption that past processes that created the correlation with pH in the different pH ranges will continue, the empirical drainage chemistry model becomes a predictive tool.

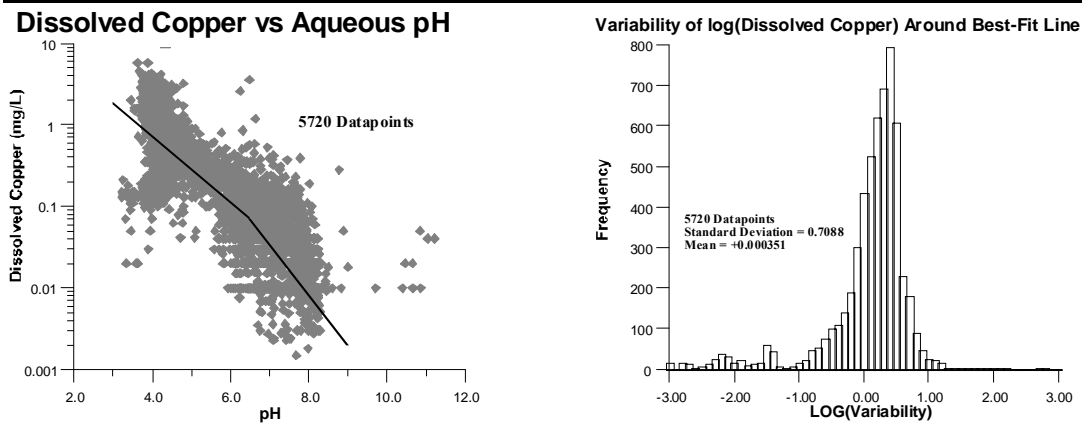
A review by Norecol, Dames and Moore (1996) concluded that empirical drainage chemistry modeling may not be statistically valid for mine sites with less than a few hundred data points. However, with adequate caution regarding statistical parameters, empirical drainage chemistry modeling with relatively small data sets can be useful in prediction (Day and Rees, 2006). Another note of caution is that previously developed empirical drainage chemistry models may not apply to the present drainage if activities, such as reclamation, result in changes in flow paths or the materials through which the water moves. More detailed instructions and discussions of empirical drainage chemistry models can be found in Morin and Hutt (1993 and 1997) and Morin et al. (1995a and b).

**Table 20.1 Example of an Empirical Drainage Chemistry Model including an open pit, several waste rock dumps and a tailings impoundment at a mine in British Columbia. (adapted from Morin et al., 1995b)**

Parameter	pH Range	Best Fit Equation	Log (Std. Dev.)
Acidity	pH < 3.5	$\log(\text{Acid}) = -0.932\text{pH} + 5.864$	0.345
	pH > 3.5	$\log(\text{Acid}) = -0.360\text{pH} + 3.862$	
Alkalinity	pH > 4.5	$\log(\text{Alk}) = +0.698\text{pH} - 3.141$	0.654
Diss. Aluminum	pH < 6.0	$\log(\text{Al}) = -0.925\text{pH} + 4.851$	0.429
	pH > 6.0	Al = 0.2 mg/L	
Diss. Arsenic		< 0.2 mg/L	0
Diss. Cadmium	pH < 3.0	Cd = 0.07 mg/L	0
	pH > 3.0	Cd = 0.015 mg/L	
Diss. Calcium		$\log(\text{Ca}) = +0.619\log(\text{SO}_4) + 0.524$	0.375
Diss. Copper	pH < 3.4	$\log(\text{Cu}) = -1.485\text{pH} + 6.605$	0.692
	3.4 < pH < 5.4	$\log(\text{Cu}) = -0.327\text{pH} + 2.666$	
	pH > 5.4	$\log(\text{Cu}) = -1.001\text{pH} + 6.307$	
Total Copper		$\log(\text{Cu-T}) = +0.962\log(\text{Cu-D}) + 0.180$	0.230
Diss. Iron	pH < 4.4	$\log(\text{Fe}) = -1.429\text{pH} + 6.286$	0.807
	pH > 4.4	$\log(\text{Fe}) = -0.455\text{pH} + 2.000$	
Total Iron		If diss Fe > 1.0, total Fe = diss Fe	0
Diss. Lead		Pb = 0.05 mg/L	0
Diss. Nickel		$\log(\text{Ni}) = -0.317\text{pH} + 0.853$	0.607
Diss. Selenium		Se = 0.2 mg/L	
Diss. Silver		Ag = 0.015 mg/L	
Diss. Zinc		$\log(\text{Zn}) = -0.441\text{pH} + 1.838$	0.667
Total Zinc		total Zn = diss Zn	0.144

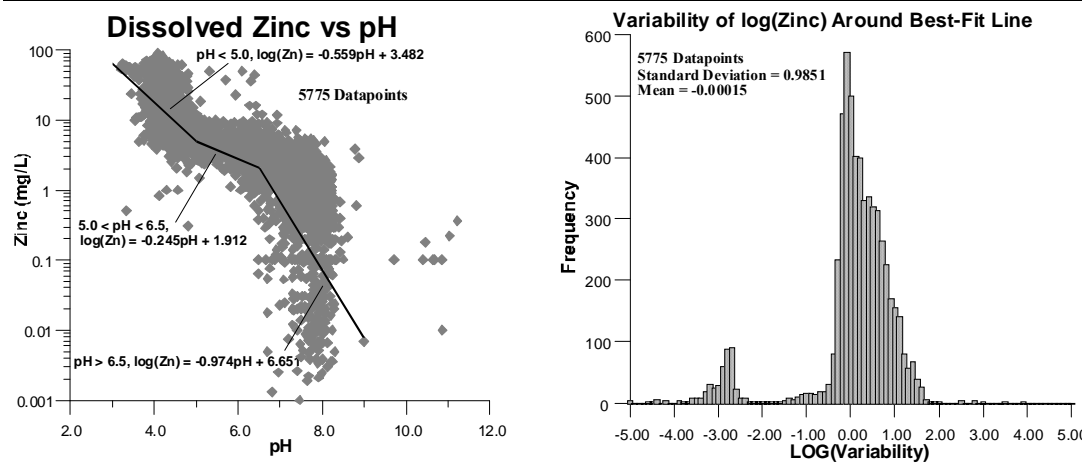


a) the empirical relationship of acidity to pH at Island Copper Mine



Best Fit: If  $\text{pH} < 6.5$ ,  $\log(\text{Cu}) = -0.406\text{pH} + 1.486$ ;  
 If  $\text{pH} > 6.5$ ,  $\log(\text{Cu}) = -0.640\text{pH} + 3.006$

b) the empirical relationship of copper to pH at Island Copper Mine



$\text{pH} < 5.0$ ,  $\log(\text{Zn}) = -0.559\text{pH} + 3.482$   
 $5.0 < \text{pH} < 6.5$ ,  $\log(\text{Zn}) = -0.245\text{pH} + 1.912$   
 $\text{pH} > 6.5$ ,  $\log(\text{Zn}) = -0.974\text{pH} + 6.651$

c) the empirical relationship of zinc to pH at Island Copper Mine

Figure 20.1 Empirical drainage chemistry correlations with pH (adapted from Morin et al., 1995a).

Strengths of empirical drainage chemistry models include that they are site specific and based on

*EDCMs do not depend on having the correct chemical equations or details of mineralogy which are difficult, or impossible to measure. A weakness is that the past processes causing the observed drainage chemistry are not necessarily*

years to decades of monitoring at many locations around a mine site. EDCMs do not depend on having the correct chemical equations or details of mineralogy which are difficult, or impossible, to measure. A weakness is that the processes causing the observed drainage chemistry are not necessarily identified

and future changes in these unknown processes can lead to a different drainage chemistry. Nevertheless, these processes can sometimes be identified (Section 20.2).

Therefore, EDCMs apply to previously monitored ranges in properties and processes. They should not be used to predict drainage chemistry outside the range of conditions associated with the previous monitoring.

## 20.2 Speciation and Mineral Equilibrium Modeling

There are many geochemical modeling programs in wide distribution that calculate chemical

*There are many geochemical modeling programs in wide distribution that calculate chemical speciation and mineral saturation indices, indicating which minerals may be dissolving or precipitating.*

speciation and mineral saturation indices, indicating which minerals may be dissolving or precipitating and hence impacting the drainage chemistry. Two of the most widely used programs are MINTEQ (U.S. EPA) and PHREEQE (U.S. Geological Survey). These programs are continually being revised to

improve their accuracy, expand their functions and make them easier to use (e.g. Visual MINTEQ and PHREEQCI Interactive). MINTEQ is available free of charge; not copyrighted and thus the program and its input/output can be freely distributed and discussed. This model is maintained and occasionally expanded by the U.S. EPA and others and MINTEQ training courses are given on a regular basis. PHREEQE has benefits similar to MINTEQ, with the additional benefit that as a research level tool, it includes geochemical simulations not possible with MINTEQ.

Comprehensive drainage chemistry analyses, including all significant dissolved cations and anions and parameters like pH, are required as a minimum to provide the data to run MINTEQ and PHREEQC simulations of speciation and mineral saturation. The interpretation of MINTEQ and PHREEQC outputs requires a good knowledge of aqueous complexation and mineral precipitation dissolution and consideration of whether assumptions in the model simulations apply to the site specific conditions of the project components.

Also, erroneous results may occur if mineral solubility deviates from that of the model or the model uses the wrong mineral. For example, the chemical compositions of minerals, especially the high concentrations of minor and trace element incorporated in minerals at a mine site, and their solubilities may vary from those in the database of a specific model. Therefore, equilibrium modeling should be used with caution and with consideration for site specific mineral composition, and solubility and kinetically controlled reactions.

Another challenge is that the capacity of geochemical equilibrium models to predict metal speciation in waters containing natural organic matter is limited. Even with more elaborated models, only the humic fractions of natural organic matter are generally considered, although other organic ligands with higher affinities might be more important (Langmuir et al., 2004).

*Minerals may not be at chemical equilibrium if the pertinent reactions are kinetically controlled. Also, erroneous results may occur if mineral solubility deviates from that used in a model or a wrong mineral is considered.*

Solubility limits are a powerful tool when matched with field evidence of the composition of drainage chemistry (Chapter 19) and secondary minerals (Chapters 11 and 17). Analysis of site drainage chemistry and precipitating secondary minerals phases should always be conducted to check that the results from geochemical modeling programs match field observations.

### 20.3 More Complex Models

There are many other complex models available around the world to simulate and predict one or more aspects of drainage chemistry. One example is WATAIL, a physical chemical program developed for the Canadian MEND Program. This program simulates some aspects of acid generation and neutralization in tailings, as well as physical movement of groundwater through a tailings area. WATAIL and other similar models were described and reviewed in detail by Perkins et al. (1995).

More recently, an old physico-chemical model developed for the National Uranium Tailings Program (NUTP) and Reactive Acid Tailings Stabilization (RATS) Program, predecessors of the MEND Program, has been updated and expanded (Martin et al., 2005). This new model, Rockstar, is a multi-nodal model that can simulate up to 20 interconnected “compartments”, including tailings, waste rock, and open pit and underground mines. As with all models, the underlying assumptions must apply to the particular site conditions or the model results could be misleading. For example, if the model simulates copper performance using the sulphide minerals, chalcopyrite and chalcocite and some secondary carbonate-hydroxide minerals, it might not provide valid predictions if copper sulphate minerals are important at the site. This illustrates the need to conduct comprehensive mineralogical and geochemical analysis, kinetic tests and geochemical speciation modeling (Section 20.2) before selecting and using such complex models.

The more complex is a model, the more intensive site specific studies and data it often needs.

*The more complex is a model, the more intensive site specific studies and data it often needs.*

Collection of the required data to sufficient accuracy can be difficult and expensive. In many cases, the enormous amount of data is impossible to collect.

Like all forms of models, it is important to keep in mind that complex models are tools to assist with the prediction of drainage chemistry and loadings, but cannot substitute for good site specific measurements and understanding and that modeling predictions are hypotheses that need to be tested before they can be accepted.



## 20.4 References

- Day, S. and B. Rees. 2006. Geochemical Controls on Waste-rock Dump Seepage at Several Porphyry Mines in the Canadian Cordilleran. In: R.I. Barnhisel (ed.) Proceedings of the 7th International Conference on Acid Rock Drainage (ICARD), St. Louis, Missouri, March 26-30.
- Langmuir, D., P. Chrostowski, B. Vigneault and R. Chaney. 2004. Issue Paper on the Environmental Chemistry of Metals. Report to U.S. Environmental Protection Agency Risk Assessment Forum. p. 114.
- Martin, J., G. Wiatzka, J. Scharer and B. Halbert. 2005. Case Studies that Illustrate the Benefits, Limitations and Information Requirements of Geochemical Modeling. In: Proceedings of the 12th Annual British Columbia - MEND Metal Leaching/Acid Rock Drainage Workshop, Challenges in the Prediction of Drainage Chemistry. Vancouver, British Columbia, November 30 - December 1.
- Morin, K.A. 1994. Prediction of Water Chemistry in Open Pits during Operation and After Closure. In: Proceedings of the 18th Annual British Columbia Mine Reclamation Symposium, Vernon, British Columbia, April 11-14.
- Morin, K.A. and N.M. Hutt. 1993. The Use of Routine Monitoring Data for Assessment and Prediction of Water Chemistry. In: Proceedings of the 17th Annual British Columbia Mine Reclamation Symposium, Port Hardy, British Columbia, May 4-7.
- Morin, K.A. and N.M. Hutt. 1997. Environmental Geochemistry of Minesite Drainage: Practical Theory and Case Studies. MDAG Publishing, Surrey, British Columbia. p. 333.
- Morin, K.A., N.M. Hutt and I.A. Horne. 1995a. Prediction of Future Water Chemistry from Island Copper Mine's On-Land Dumps. In: Proceedings of the 19th Annual British Columbia Mine Reclamation Symposium, Dawson Creek, British Columbia, June 19-23.
- Morin, K.A., N.M. Hutt and R. McArthur. 1995b. Statistical Assessment of Past Water Chemistry to Predict Future Chemistry at Noranda Minerals' Bell Mine. In: Proceedings of the Conference on Mining and the Environment, Sudbury, Ontario, May 28 - June 1, Volume 3.
- Norecol, Dames, and Moore. 1996. Guide for Predicting Water Chemistry. Canadian Mine Environment Neutral Drainage (MEND) Report 1.27.1a.
- Perkins, E.H., H.W. Nesbitt, W.D. Gunter, L.C. St-Arnaud and J.R. Mycroft. 1995. Critical Review of Geochemical Processes and Geochemical Models Adaptable for the Prediction of Acidic Drainage from Waste Rock. MEND Report 1.42.1.



## 21.0 CHECKLIST OF IMPORTANT INFORMATION FOR THE PREDICTION OF DRAINAGE CHEMISTRY

### *Some Important Points in this Chapter*

*This chapter provides a detailed checklist of potentially important information for predicting drainage chemistry from sulphidic materials. This list is intended to make the technical specialist aware of general issues and the generalist practitioner aware of detailed information requirements. Every mine site has unique combinations of environmental, geological and operational conditions. For any particular site, some properties and processes within this list may not be relevant. Similarly, there will be instances where there are additional factors to consider. Minimizing environmental risks and liability includes consideration of near-neutral and alkaline conditions, as well as acidic drainages and the reduction of water and/or oxygen entering a project component. At each stage of prediction, one should consider the purpose of the test work and whether the results will impact site management, liability or the risk to the environment. In some cases, the provision of contingency mitigation measures coupled with operational testing during mining will be more effective than additional pre-mining prediction test work, which could be inconclusive or of limited significance to the overall mine plan. In all cases, there is never complete understanding, so a critical part of any drainage chemistry prediction is identifying and dealing with uncertainty.*

### 21.1 Introduction

The depth and breadth of information and experience required in the prediction of drainage chemistry and of metal leaching and acid rock drainage (ML-ARD) produced by sulphidic geologic materials, can sometimes be overwhelming. As a result, it is possible to overlook critical pieces of information. In addition, many properties and processes are difficult to measure and there is a tendency to focus on the most familiar or easily measured factors.

*The depth and breadth of information and experience required in the prediction of drainage chemistry can sometimes be overwhelming.*

The objective of this chapter is to provide a detailed checklist of potentially important properties and processes. This list is intended to make the technical specialist aware of general issues and the generalist practitioner aware of detailed information requirements.

While the checklist will help ensure relevant issues are considered, it is only intended as a starting point. Every mine site has unique combinations of environmental, geological and operational conditions. Best management practices for drainage chemistry are the tools and procedures needed to develop a site specific understanding of the natural environment, the mine site, the materials involved, the environmental protection requirements and the resulting opportunities and constraints. For any particular site, some properties and processes within this

list may not be relevant. Similarly, there will be instances where there are additional factors to consider.

When developing or reviewing mining plans, this chapter can be used to identify outstanding

*This chapter can be used to identify outstanding and information requirements that are not applicable. The preceding chapters on specific aspects of prediction should be consulted for more detailed information.*

information requirements and information that is not applicable. The preceding chapters on specific aspects of prediction should be consulted for more detailed information on their various properties, processes, analyses and tests.

Where no work or no further work is required on a particular aspect of prediction, it is important to explain why. Various factors can influence practices and it is very useful to document the rationale for decision making; for example where mitigation decisions are made based on material characterization and vice versa.

## 21.2 General Information Requirements

There are a large number of objectives in the prediction of drainage chemistry from sulphidic

*There are a large number of objectives in the prediction of drainage chemistry from sulphidic geologic materials.*

geologic materials. The primary objectives are to minimize environmental risks and liability, which include the risk of unacceptable water quality and the implementation of cost-effective mitigation. Important general site information for the prediction of drainage

chemistry (Chapter 6) typically includes:

- general site information, including location, access, topography, climate and ecology;
- site history, including an overview of mine development, mining and processing, waste materials and site components;
- geology and mineralogy, including identity and description of all geological materials excavated, exposed or otherwise disturbed by present and past mining activities;
- site hydrology and hydrogeology;
- soils and other geotechnical aspects of the site;
- environmental and reclamation objectives, including species sensitivity, distribution and potential mechanisms of exposure, regulatory history and current conditions, end land use objectives, discharge limits and receiving environment objectives;
- information sources, including literature reviewed; and
- figures (site plan and maps of location, topography and drainage) and tables.

These general site items should include information that pertains to the entire site. The more detailed information items, such as for specific waste materials or site components, are discussed in the following sections.

### 21.3 Material Characterization and Drainage Chemistry Prediction

The current composition and prediction of future drainage chemistry would be useful to determine for each geological material (e.g. rock type and surficial material), project component and waste type (Chapter 7). The selection and collection of samples (Chapter 8), sample preparation, assays, test procedures (Chapters 9 to 19) and data interpretation (Chapter 20) should be based on the availability of representative materials, project needs and other site specific requirements, such as probable weathering environment and geological make-up. Available analytical procedures may be limited in some parts of the world.

*The current composition and prediction of future drainage chemistry would be useful to determine for each geological material, project component and waste type.*

The assessment of materials should show the statistical distribution and variability of key geochemical parameters (such as Acid Base Accounting results and metal concentrations in solids or drainages), potential discrepancies between results and reality (e.g. laboratory determined AP and NP versus effective AP and NP available under field conditions) and where applicable, the timing of significant geochemical events, such as the onset of ARD or significant metal leaching. Depending on the phase of project development and the available information, the assessment should show pre-mining, operational, post-mining and future results and predictions, including loadings and resulting environmental impacts.

It is important to remember that the primary purpose for the geochemical assessment is to guide management decisions. The significance of contaminant release and inaccuracies in prediction will depend on loadings, available dilution/attenuation and the sensitivity of the receiving environment. At each stage of the test program, one should consider the purpose of the test work and whether the results will impact site management, liability or the risk to the environment. In some cases, the provision of contingency mitigation measures coupled with operational testing during mining will be more effective than additional pre-mining prediction test work, which could be inconclusive or of limited significance to the overall mine plan.

*It is important to remember that the primary purpose for the geochemical assessment is to guide management decisions.*

The following sections contain a listing of generally recommended information and analytical needs and procedures for the presentation and interpretation of the results.

### 21.4 Geology and Mineralogy

#### 21.4.1 Geological Properties

Geological properties potentially influencing weathering and drainage chemistry include:

- types of rock and non-lithified surficial materials;
- mineralization and the effects of hydrothermal alteration and surficial weathering processes;
- descriptions of different geological units, including visual properties and their spatial distribution; and
- rock strength (e.g. slaking in water).

Plan views and cross sections of the site should be used to show the spatial relationship between the various rock units, different forms of mineral alteration, outline of underground workings and/or pit and ore versus waste.

#### 21.4.2 Mineralogy

Properties of mineral phases potentially influencing weathering and drainage chemistry include:

- identity;
- mode of formation;
- abundance;
- concentration of major elements;
- concentration of elements occurring as impurities;
- size, frequency and chemistry of inclusions;
- size, frequency and chemistry of weathered surface layers and coatings precipitated from the products of the previous weathering;
- grain size distribution;
- spatial distribution;
- mineral associations;
- exposed surface area; and
- crystal shapes and surface deformities.

Identification of mineral phases is used to predict relative weathering rates under different weathering conditions. Measurement of mineral abundance (quantitative phase analysis) is used to predict the total contribution of different mineral phases under different weathering conditions.

The most commonly used mineralogical analysis procedures are the following:

- visual description;
- petrographic analysis; and
- X-ray Diffraction (XRD).

Additional mineralogical information may be provided by:

- Scanning Electron Microscopy with an Energy Dispersive Spectrophotometer (SEM/EDS);
- electron microprobe;
- laser ablation and other microbeam techniques; and
- image analysis.

The most common techniques to acquire mineral abundance data are petrographic point counting, X-ray Diffraction (XRD) analysis and microscopic image analysis. Mineral identity will, to a varying degree, indicate the concentration of elements that are a major part of the mineral composition. Scanning Electron Microprobe (SEM or electron microprobe analysis) may be required to determine the composition of minerals not readily identified by optical methods or XRD, including the composition of carbonate and other solid solution minerals, and to identify the mineral source for potential contaminants and whether elemental composition can be used to estimate quantitative mineralogy (e.g. use of Ba to estimate % barite).

## 21.5 Sample Selection, Storage and Preparation

Some considerations to keep in mind when planning sampling campaigns include:

- type of samples to collect (e.g. drill core, drill cuttings and < 2 cm fraction of post-blast material);
- dimensions and weight of samples to collect;
- where, when and how often to sample (e.g. number of samples collected from each geological unit and amount of material purportedly characterized by each sample);
- sampling procedure (e.g. composites of grab samples taken every meter along a transect or cross section of drill cuttings);
- sample description (e.g. exposure of test material to weathering prior to sampling);
- sample storage (e.g. storage in an oxygen free environment); and
- sample preparation prior to analysis and test work (e.g. drying, sieving, crushing and grinding).

Sampling requirements will depend on the:

- prediction objectives;
- geological materials, waste materials, excavations and project components;
- stage of project development;
- stage of prediction;
- timing of management actions and regulatory decisions;
- phase being sampled (e.g. solid, drainage or gas);
- subsequent analyses and test work to be performed on the samples and the properties and processes they will measure (e.g. < 2 mm size fraction of waste rock, or dissolved portion of the total drainage concentrations);
- accessibility of the representative material;
- ability to collect and prepare samples without changing the targeted properties and processes;
- variability of the targeted properties and processes; and
- accuracy and precision required of the prediction.

Plan views and cross sections of the site are typically needed to show the spatial distribution of samples within rock units, different forms of mineral alteration and variability in key properties and processes. Diagrams should outline the underground mine and/or open pit and the boundary between the ore and the waste.

## 21.6 Static Tests: Measurement of Material Composition

Static tests measure chemical, physical and mineralogical composition of a sample.

### 21.6.1 Elemental Analysis

Elemental analysis includes measurement of the whole-rock or near-total and soluble solid phase constituents.

#### a) Whole-Rock or Near-Total Solid Phase Concentration

Whole-rock or near-total solid phase elemental analyses measure the concentration of elements of potential concern with regards to future drainage chemistry. Analytical methods and their results may vary due to differences in the methods for sample digestion and for the subsequent analysis of the digested sample.

Comparison with crustal variability or regional background may be used to identify elements occurring in relatively high concentrations. Depending on the mineral phase, weathering and leaching conditions, these elements may be of no environmental concern.

#### b) Water Soluble Solid Phase Concentration

The source, dissolution rate and total mass of soluble constituents and the resulting drainage chemistry, are a function of the:

- solubility of the solid phase constituents;
- chemistry of the drainage;
- solubility limits;
- ratio of water to solid; and
- residence time.

Analytical methods and their results may vary due to differences in the methods for:

- sample pretreatment;
- ratio of water to solid;
- type of extractant;
- time of leaching;
- number of repetitions; and
- degree of agitation.

Interpretation of results may include:

- predicted loadings;
- geochemical modeling of solubility constraints; and
- identification of potentially problematic weathering or leaching conditions.

Potential solubility concerns include changes in drainage chemistry (e.g. changes in redox potential), unusual mineralogy or previous oxidation and/or leaching due to natural weathering (e.g. supergene processes) or delays in mitigation.



### 21.6.2 Acid Base Accounting

Acid Base Accounting (ABA) consists of a series of compositional analyses and calculations used to estimate the potential for mineral weathering to produce acidic drainage if the sampled sulphidic material is exposed to oxygen and water.

- a) Sulphur Analyses (total-S, sulphate-S, organic-S and sulphide-S) and Acid Potential (AP)
  - Corresponding mineralogical information.
  - Analytical methods and calculations, including how sulphide-S was measured and AP calculated.
  - Concentration of sulphide-S in minerals potentially generating a different amount of acidity per unit S than pyrite.
  - Presence of coal, mudstone, peat or plant material, indicating the presence of organic sulphur.
  - Concentrations of acid leachable and non-acid leachable sulphate and whether they are a significant portion of total sulphur and can affect the calculation of AP; non-acid leachable sulphate species include barite (Ba) and anglesite (Pb).
  - Concentration of acid sulphates (e.g. jarosite and alunite).
  - Potential for sulphide occlusion from oxygen or drainage.
  - Potential for galvanic control on sulphide oxidation.
  
- b) Bulk or Acid Titratable Neutralization Potential (Bulk NP)
  - Supporting mineralogical information (carbonate composition and types of silicates).
  - Analytical methods.
  - If some variation on the Sobek or Modified procedure was used, the fizz rating and how the acid addition compared with the resulting NP and the estimated calcium and magnesium carbonate content.
  - Potential contribution to NP from calcium and magnesium carbonate, net non-neutralizing ferrous iron and manganese carbonate and reactive silicate minerals.
  - NP measured in samples with an acidic pH.
  
- c) Carbonate Neutralization Potential (CO<sub>3</sub>-NP)
  - Relevant mineralogical information.
  - Analytical methods.
  - Concentration of calcium and magnesium carbonate versus net non-neutralizing ferrous iron and manganese carbonate.
  
- d) pH
  - Sample preparation and its influence on pH measurement.
  - Analytical methods, including sample pretreatment that may mix weathered surfaces with fresh material and the ratio of water to solid.
  - Results of rinse versus crushed/paste pH.
  - Whether materials are already acidic.

See Section 21.9 for an outline of how to identify potentially ARD generating materials and non-potentially ARD generating materials.

### 21.7 Kinetic Tests: Measurement of Reaction Rates and Drainage Chemistry

Kinetic tests are experimental designs that allow the ongoing measurement of weathering and leaching rates and conditions of the sample and/or the sample's drainage chemistry. The information from kinetic testing includes:

- rates of acid generation and neutralization;
- changes in geochemical properties, such as solid phase depletion of a soluble element;
- time to net acidic conditions; and
- drainage chemistry and contaminant loadings.

Generic information requirements that should be addressed where possible in any kinetic tests are:

- detailed pre-test characterization of the geological materials and project components under investigation;
- detailed pre-test static characterization of the test material;
- monitoring of drainage, weathering and leaching conditions and reaction rates and changes in the test material; and
- post-test characterization of the test material, again requiring detailed static testing.

Monitoring of drainage includes measurement of:

- drainage chemistry (pH, redox potential, alkalinity, acidity, hardness,  $\text{SO}_4$ , Fe, Al, Mn, Ca, Mg, K, Na, other base cations,  $(\text{Ca}+\text{Mg})/\text{SO}_4$  and trace elements);
- flow rates;
- loadings; and
- solubility constraints (results of geochemical modeling).

Pre- and post-test characterization of the test material is needed to:

- identify the properties and processes of concern;
- determine the prediction questions that kinetic testing needs to answer;
- select the appropriate kinetic tests, test conditions and experimental designs;
- identify mineral sources for different chemical species in the drainage;
- determine the portion of the project component that is a concern and select samples of that material to use as test materials; and
- estimate the duration or time to onset of key weathering and leaching conditions and predict how long the kinetic test should be run to answer the prediction questions.

Factors to consider in test selection and the interpretation of results include the following:

- whether the test occurs in the laboratory, at the mine site or at some other suitable field site;
- the scale of the test - full or reduced;
- comparison between test materials and the materials they represent;
- test procedure, including preparation of test materials and rate of leaching;
- differences among the tests and between tests and field conditions in weathering and leaching conditions and inputs and how this may alter weathering properties and processes;

- whether the measurement objective is the drainage chemistry or the rate of primary mineral weathering. Measurement of primary mineral weathering requires an action to eliminate solubility constraints. Usually this is accomplished with aggressive leaching or flushing that limits secondary mineral precipitation. Measurement of drainage chemistry and primary mineral weathering are often mutually exclusive; and
- duration of test and changes observed.

Potential sources of kinetic data include the following:

- natural non-lithified surficial material (e.g. talus) and outcrops from materials with a geological and geochemical composition similar to the material of concern, and that have been exposed to similar weathering and leaching conditions;
- other site materials with a similar geological and geochemical composition and weathering and leaching conditions;
- laboratory humidity cell tests;
- laboratory trickle leach columns;
- wall washing stations;
- field test pads; and
- full-scale project components.

### 21.7.1 Humidity Cell

The humidity cell is the recommended kinetic test for predicting primary reaction rates under aerobic weathering conditions. The resulting data provides a measure of the rates of elemental release, acid generation and acid neutralization under the geochemical conditions encountered in the test.

Properties and processes which can cause discrepancies between humidity cell and field rates include:

- any precipitation of weathering products;
- pretreatment grinding and crushing may damage mineral grains, exposing soluble base cations and hydroxides, making the minerals more susceptible to weathering and creating additional acid potential and/or neutralization potential compared to that which would be expected under normal operational conditions;
- the portion able to contribute to drainage chemistry may be much larger in a crushed humidity cell sample than in the actual waste rock and pit walls; and
- reduction in particle size by crushing used to produce material that will fit in laboratory test does not discriminate between high and low strength portions of the rock and thus the fines in the test sample may include material that due to its physical stability would normally occur as coarse fragments or relatively unfractured mine walls.

It should be kept in mind that humidity cell procedures do not simulate the precipitation and dissolution of secondary weathering products very well. Both of these processes often determine drainage chemistry under field conditions.

### 21.7.2 Kinetic Tests that Measure Primary Mineral Weathering and Secondary Mineral Precipitation and Dissolution

Drainage chemistry depends on both the primary mineral reactions and the precipitation and dissolution of the resulting secondary minerals. Under small-scale conditions, the recommended laboratory procedure for measuring drainage chemistry, contaminant loadings, changes in geochemical properties and time to net acidic conditions is a trickle leach column. Field based procedures for measuring drainage chemistry, contaminant loadings, changes in geochemical properties and time to net acidic conditions are:

- field test cells;
- wall washing stations; and
- monitoring of the actual dumps, pits, impoundments or underground workings.

Field information may also be obtained from natural non-lithified surficial material (e.g. talus) and outcrops or other older disturbed materials.

Properties and processes which can cause discrepancies between tests and field rates for large scale mine components include:

- temperature changes or air entry may be far greater if the test material is smaller or has a higher ratio of edge to mass;
- pretreatment grinding and crushing may damage mineral grains, exposing soluble base cations and hydroxides, making the minerals more susceptible to weathering and creating additional acid potential and/or neutralization potential compared to that which is normally available in operations;
- the portion able to contribute to drainage chemistry may be much larger in a crushed humidity cell sample than in the actual waste rock and pit walls; and
- reduction in particle size by crushing used to produce material that will fit in a laboratory test does not discriminate between high and low strength portions of the rock and thus the fines in the test sample may include material that due to its physical stability would normally occur as coarse fragments or relatively unfractured mine walls.

The location of monitoring sites (e.g. seeps, mine drainage locations and pits) and mine components contributing to the drainage are important considerations in the monitoring of the actual dumps, pits, impoundments or underground workings. Climate data is an important part of all field based procedures.

## 21.8 Assessment of Different Waste Materials and Site Components

Where possible, one should outline volumes and approximate mining sequences for different materials and how and where they will be, are or were handled and disposed. Factors to consider will vary depending on the waste material and site component or depositional environment. For example, the break down of larger particles and their subsequent mixing with the underlying material are potential issues when waste rock is used to surface roads. Potential waste materials include: waste rock, tailings, various by-products such as cycloned sand produced from tailings, low grade ore, treatment wastes and construction materials. Site components from present and

past mining activities include: waste rock dumps, impoundments, mine workings (open pits and underground workings), temporary stockpiles and roads. Some factors to consider in the assessment of these components are provided in the next three sub-sections.

### 21.8.1 Waste Rock and Waste Rock Dumps

- Pre-mining prediction
  - Pre-mining prediction is usually based on an analysis of exploration drill core.
  - One question to consider is, how representative is the analysis of drill core or cuttings (whole rock) of the composition of different areas of the mine workings or particle size fractions of the resulting waste rock and tailings?
  - Exploration usually focusses on ore and there may be no drill core available to predict the composition of waste rock at the edge of the ore zone, where there is potential for features such as a distal pyrite halo.
  - Composition of the particle size determining drainage chemistry. The finer sized, reactive portion of the waste rock may be different from the whole rock.
- Results during mining from sampling of pre-blast drill cuttings.
- Results during mining from post-blast sampling prior to removal of waste rock from pit or after placement on dumps, including relative mass and concentration of AP and NP in fines versus coarser particles.
- Post-disposal weathering, including changes in pH, carbonate content, soluble weathering products and oxygen concentration.
- Thermal properties and pore gas composition of waste rock dumps, such as temperature and oxygen concentration.

Obtaining good representative samples is often far more difficult after the waste has left the pit.

### 21.8.2 Tailings

- Prior to mining, results from an analysis of drill cores intersecting ore, and bench scale and pilot scale metallurgical test work.
- During mining, results from the analysis of ore, whole tailings and different potential tailings fractions including cleaner and rougher tailings, cycloned tailings sand used for underground backfill or dam construction, and desulphurized tailings.
- Amendments added during processing.
- Potential segregation during deposition resulting in differences in the composition of tailings beach and slimes.
- Post-disposal weathering, such as changes in pH, carbonate content, soluble weathering products and oxygen consumption.
- Depth of the water table and oxygen depletion and consequent constraints on sulphide oxidation.
- Production of thiosalts.

There is a great deal of value in testing ore, intermediate tailings and final tailings in both metallurgical test work and subsequent processing operations. Oxygen content is often estimated from the water content in the field and from the soil water characteristic curve.

The production of thiosalts during milling and subsequent ARD production in tailings effluent is an issue with some high sulphide ores at a number of mines in Eastern Canada and at least one mine in British Columbia. It would therefore be prudent to check high sulphide ores for thiosalts during the metallurgical test work.

*The production of thiosalts during milling and subsequent ARD production in tailings effluent is an issue with some high sulphide ores at a number of mines in Eastern Canada and at least one mine in British Columbia.*

### 21.8.3 Mine Workings – Open Pits and Underground Mine

- Composition of mine walls and degree of fracturing.
- Composition, mass and location of backfill, fractured bedrock (e.g. ore broken apart by blasting but not removed) and talus.
- Hydrology and hydrogeology, including location and rates of flow, height of the water table, and timing and location of discharge.
- Weathering, drainage chemistry and loadings at different locations.

Typically, backfill and talus contribute significantly more reactive surface area, and are thus more important determinants of drainage chemistry than mine walls and fractures.

## 21.9 Interpretation of Geochemical Results

### 21.9.1 General Considerations

A common concern is how much information to provide. “The devil is often in the details” and therefore a comprehensive explanation of details is generally required (e.g. how samples were collected and whether analyzed samples are representative of the overall population). Only a small portion of the material may be sufficient to produce significant ARD or metal leaching. Consequently, variability and distribution of parameters such as NPR (NP/AP) and metal concentrations are typically more important than central tendency or average compositions. Descriptive statistics such as the 10th and 90th percentile and the median are a useful way to describe the variability, in addition to plots showing the distribution of data. Non-parametric statistics may be more useful than those that assume a normal distribution. Sensitivity analysis can be used to determine whether additional information is required. Spatial variability is important in determining when geochemically different materials are mined and whether segregation is possible.

*A common concern is how much information to provide.*

Plan views, cross sections, block models and bench plans of the site are typically used to show the spatial relationship of variability in drainage chemistry properties and their correlation with rock units and different forms of mineral alteration. Diagrams should show sampling locations, the outline of the underground workings and/or pit and the location of the ore versus waste materials.

### 21.9.2 Identifying Potentially ARD Generating Materials

It is important to recognize that the primary source of harmful effects is often metals and that unacceptably high metal leaching may occur with neutral pH drainage. At other sites, water quality is only a concern if the wastes generate ARD. However, even where the drainage is neutral, the higher metal solubility and weathering rates in localized regions with acidic weathering may be a major source of metals and therefore the identification of ARD generating materials is important.

*The primary source of harmful effects is often metals and unacceptably high metal leaching may occur with neutral pH.*

In drainage chemistry test work, the first step in assessing whether the neutralizing minerals in a sample are sufficiently plentiful and reactive to neutralize the acidity generated from the oxidation of sulphide minerals is normally to calculate the acid potential (AP) and neutralizing potential (NP). The ARD potential is then predicted from the NP:AP ratio (NPR). Assuming the AP and NP are accurate and there is exposure to air and leaching, ARD is judged likely if the NPR is < 1, uncertain if the NPR is 1 to 2 and of low probability if the NPR is > 2.

A key part of the assessment of potentially ARD generating materials is the way in which AP and

*A key part of the assessment of potentially ARD generating materials is the way in which AP and NP are measured and the discrepancies with acid generation and neutralization in the materials under the mine site conditions.*

NP are measured and the discrepancies with acid generation and neutralization in the materials under the mine site conditions. In order to be quick and repeatable, procedures used to measure AP and NP provide a relatively fast approximation of the large number of factors and processes

that contribute to effective acid generation and neutralization in the field. Consequently, corrections may be required to take into account site specific conditions and divergence from the assumptions regarding mineralogy. Corrections or safety factors may also be used to account for sampling limitations, the heterogeneity of key properties and the composition of the sample (e.g. drill cuttings created from whole rock) versus actual reactive portion of the material (e.g. dump fines).

### 21.9.3 Identifying Non-Potentially ARD Generating Materials

The decision about how to handle non-PAG material will depend on whether neutral or alkaline pH leaching is a concern. The effect of neutral or alkaline pH leaching will depend on the mineral source and concentration of metals, weathering rates, loadings and the sensitivity of the receiving environment. Reasons for identifying non-potentially ARD generating (non-PAG) material where metal leaching is not a concern include limiting costs and risks associated with unnecessary mitigation (e.g. size of the dam if the material must be flooded) and its use as a construction material. Tasks include setting criteria for what is PAG versus non-PAG for each different geological material and determining whether the non-PAG material can be separated. PAG versus non-PAG criteria are typically based on NPR and require an assessment of the mineral sources for measured AP and NP. Criteria should consider differences in monitored versus actual reactive wastes (e.g. composition

*The decision about how to handle non-PAG material will depend on whether neutral or alkaline pH leaching is a concern.*

of waste rock fines versus drill core whole rock results) and how to operationally measure the parameters used in the criteria (e.g. sampling procedure and frequency, analysis procedures and whether corrections should be made to calculated NP, AP or the NPR).

In addition to the resulting drainage chemistry, use of non-PAG material also depends on whether non-PAG material can be segregated from PAG. This requires an assessment of the spatial distribution of non-PAG and how to operationally distinguish and segregate it from PAG material (e.g. how to operationally estimate the NPR). Block models are often valuable tools in assessing the spatial distribution of waste materials with different geochemistries.

*Use of non-PAG material also depends on whether non-PAG material can be segregated from PAG.*

#### 21.9.4 Predicted Drainage Chemistry and Metal Loading

Predicted drainage chemistry and metal loadings depend on:

- weathering environment (see waste rock and tailings);
- surface area effects (e.g. relative proportions and composition of fine and coarser particles);
- rate of leaching and drainage discharge from wastes and mine workings, including impact of rebound in the water table following mining;
- predicted ML-ARD potential, the proportion and spatial distribution of materials judged likely to produce ARD and/or significant metal leaching and if potentially acid generating (PAG), the predicted time until ARD onset; and
- predicted metal release and solubility constraints, including supporting results of various kinetic tests and geochemical modeling.

Downstream alkalinity, dilution and metal attenuation may affect downstream drainage chemistry and its impact.

Environmental impacts depend on species sensitivity, distribution and duration and form of exposure. Pre-mining metal loading may be important in determining receiving environment and reclamation objectives. Metal loadings from adjacent areas are required to determine cumulative stresses on the system, another potentially important factor in determining receiving environment and reclamation objectives.

*Environmental impacts depend on species sensitivity, distribution and duration and form of exposure.*

#### 21.9.5 Time to Onset of ARD

The objectives in determining the time to onset of ARD are to set criteria for minimum time prior to flooding or implementing other remedial measures (such as processing of low grade ore or placement of engineered covers) to prevent significant additional weathering and/or to assess the impact of delays. This requires an estimation of the rate of sulphide oxidation (mg SO<sub>4</sub>/kg/unit time), the amount of acid produced, the subsequent decline in NP and the resulting time to NP depletion. The relevance of ARD onset for different rock units will depend on their impact on the net drainage chemistry and overall metal loadings to the environment.



## 21.10 Prediction Information Requirements for Mitigation Measures

General factors to be considered in planning mitigation measures include:

- design objectives, including contaminant loadings and the extent to which contaminant loadings are or will be reduced; and
- areas of significant uncertainty regarding drainage chemistry, including potential changes, their management implications, contingency plans and studies aimed at reducing uncertainty and guiding or improving future management.

Prediction data will play a major role in the selection of mitigation measures and their design.

*Prediction data will play a major role in the selection of mitigation measures and their design.*

Dealing with future changes in site hydrology and waste geochemistry is an important aspect of proactive mitigation. Where sulphidic wastes will become increasingly more oxidized or changes in site hydrology may increase leaching, potential increases in metals and acidity and the possible need for additional environmental protection measures should be assessed.

## 21.11 Flooding of Mine Wastes and Workings

The following sections describe the requirements to keep in mind when considering flooding of mine wastes as a mitigation measure.

### 21.11.1 Flooded Wastes

- Waste types (e.g. waste rock, tailings and treatment products), quantities, handling and disposal locations.
- Waste characterization, including potential for ARD or significant metal leaching if left exposed.
- Concentration of potentially soluble contaminant species with present drainage chemistry and predicted changes in factors such as pH, redox potential or leaching.
- Short term (one time) load of soluble chemicals versus the ongoing leaching that can occur in submerged waste, because they can have different implications for assessment and mitigation.

This information can be used to determine what material requires flooding, the required storage

*This information can be used to determine what material requires flooding, required storage capacity, maximum exposure prior to flooding and need for supplemental remediation measures.*

capacity, maximum exposure prior to flooding and the need for supplemental remediation measures. Potentially soluble species include products of pre- and post-excavation weathering and precipitates created when wastes or drainage are added to the impoundment.

### 21.11.2 Delay in Flooding

The information below can be used to determine flushing of oxidized wastes, maximum permissible exposure prior to flooding, whether there is a need for supplemental measures prior to flooding and triggers for their use:

- amount of aerial exposure prior to flooding;
- predicted time to ARD and build-up of significant soluble acidity and metals; and
- impact on chemistry of water cover and potential for future contaminant discharge.

### 21.11.3 Incomplete Flooding

Factors to consider for the case of incomplete flooding include:

- location of water table and water content in the vadose zone and the extent of flooding (e.g. exposed mine walls or tailings beach adjacent to dams); and
- resulting impact of aerial weathering on flooded drainage chemistry.

### 21.11.4 Chemistry of Water Cover and Impoundment Discharge

The following are expected to influence the chemistry of the water cover and thus the composition of the discharge from the impoundment:

- composition of waste and rates of waste disposal;
- composition and rates of drainage inputs, such as process water, pore water (e.g. through consolidation of wastes), runoff from other wastes, groundwater, precipitation and discharge of other water sources (e.g. sewage);
- previous or predicted changes within wastes and the water cover (e.g. development of reducing conditions in oxidized wastes or decreasing pH as a result of acid inputs from precipitation, nitrification of ammonium or unflooded materials); and
- previous or predicted contaminant attenuation within wastes (e.g. precipitation of trace metals as sulphides by sulphate reducing bacteria or by co-precipitation with iron hydroxides) and the water cover (e.g. uptake or adsorption by biota).

Solute release into an overlying water cover and discharge from an impoundment will depend on the composition of wastes and the drainage. Solute release is determined by the composition of particle surfaces and pore water. In unweathered finer materials, the composition of the particle surfaces is often similar to the interior of the particles. For pore water, unweathered waste rock and tailings often have relatively high alkalinity (created by blasting and handling in the case of waste rock and crushing and grinding in the case of tailings). Thus, the rinse pH of unweathered waste rock will be similar to the paste pH and the abrasion pH of the exposed minerals. The initial pH of tailings is usually similar to that of process water, rather than the abrasion pH because process additives can have large impact on the water chemistry.

Weathering of materials prior to their deposition can alter the composition of particle surfaces and pore water and the resulting chemistry of the water cover. After waste deposition in an impoundment ceases, alkalinity of

*Weathering of materials prior to their deposition can alter the composition of particle surfaces and pore water and the resulting chemistry of the water cover.*

the water cover may decrease due to the decreased flushing of wastes, lower pH of precipitation and runoff and reaction of materials in the impoundment (e.g. acid produced by oxidation of ammonium to nitrate). Long term metal release from flooded wastes will depend on a large number of site specific and mineral specific factors. For example, reduced sulphur species containing minerals such as sulphide minerals are generally stable in anoxic or low redox potential environments and secondary mineral products of oxidation are more stable in oxic or more oxidizing environments.

## **21.12 Measures to Reduce Infiltration of Drainage and/or Entry of Oxygen**

The prediction concerns are with the composition, discharge from and weathering of sulphidic materials subjected to measures to reduce infiltration of drainage and entry of oxygen. Measures to reduce drainage infiltration and oxygen entry include dry covers and other measures, such as ditches which are designed to divert drainage inputs.

### **21.12.1 Overall Mitigation Objectives for Drainage Chemistry**

Mitigation objectives include the following:

- performance targets (e.g. to limit drainage inputs and subsequent leaching); and
- required reductions in contaminant loadings (e.g. 100 times reduction in zinc loadings)

### **21.12.2 Resulting Performance of Contaminant Source**

- Total contaminated drainage and individual seep chemistry.
- Rates and locations of flow and loadings from the underlying waste.
- Changes in the composition of the waste and pore water (weathering).
- Variation in the height of water table, thermal properties and composition of the gas.

The assessment needs to consider the issue of timing and the lag times that will be associated with weathering processes and the typically slower flow of water in the subsurface.

## **21.13 Drainage Treatment**

Prediction concerns are related to the composition, discharge from and weathering of sulphidic materials that are contaminated water sources and treatment waste products. Drainage treatment includes all forms, for example: lime treatment, anoxic limestone drains, wetlands, pit lake fertilization. Another important concern is the duration of treatment that may be required.

### Contaminated Water Sources

- Potential contaminated drainage sources.
- Discharge locations.
- Predicted and measured seasonal, annual and long term variability of flow, chemistry and acid and metal loadings.

### Disposal of Treatment Waste Products

- Predicted and subsequent quality and quantity of any secondary wastes.

### 21.14 Addition of NP during Waste Production and Deposition

The prediction concerns are with the composition, discharge from and weathering of the resulting composite or amended sulphidic materials. These include sulphidic materials produced from the mixing or blending of PAG with non-PAG wastes and lime/limestone additions to PAG wastes. Often these measures are used in conjunction with measures to reduce leaching. Some of the factors that will influence how and if these measures are implemented are:

- material characterization, including results of physical, chemical and mineralogical test work on proposed materials, composition and magnitude of the reactive fractions of blended wastes and acceptability of neutral pH drainage chemistry; and
- pre- and post-deposition material characterization, including sampling, sample preparation, analysis, communication of results and time taken.

### 21.15 Desulphurization of Tailings

The prediction concerns are with the composition of the initial feed and the composition, discharge from and weathering of the resulting desulphurized tailings materials. The following information would be useful in evaluating this mitigative strategy:

- characterization of ore and whole tailings, including results of physical, chemical and mineralogical test work;
- requirements of desulphurized material, including disposal objectives, criteria to prevent ARD and significant leaching, and data used to set criteria; and
- test work, including methodology and results of bench, pilot and field-scale test work, and effects of differences in ore on the composition of desulphurized material.

### 21.16 Dealing with Uncertainty and Sufficiency of Information

Management decisions are based on available information regarding pertinent conditions, objectives, costs and societal needs. There is never complete understanding and perfect prediction and thus a critical part of any drainage chemistry prediction program is identifying and dealing with uncertainty. For this reason, it is important to consider all reasonably possible outcomes or reasonable interpretations of monitoring and material characterization, not just the presently most probable or manageable hypothesis. Similarly, when developing mitigation plans, it is important to document the uncertainties and show how they will be monitored and managed through measures such as further test work, adaptive management and contingency plans.

*There is never complete understanding and perfect prediction, and thus a critical part of any drainage chemistry prediction program is identifying and dealing with uncertainty.*

It would be useful to conduct sensitivity analysis and risk assessment at each stage of a drainage chemistry prediction program to determine the sufficiency of available information and the impact of possible inaccuracies on the overall environmental risk and liability. Some issues to be evaluated include: potential impacts on predicted waste volumes, the capacity for waste segregation and storage, availability of construction materials, expected drainage chemistry and the ability to meet discharge limits and receiving environment objectives. The results of the sensitivity analyses and risk assessment can be used to determine operational monitoring requirements and to establish where additional safety factors or contingency protection measures may be necessary.

**GLOSSARY OF TERMS USED IN PREDICTION OF DRAINAGE CHEMISTRY FROM  
SULPHIDIC GEOLOGIC MATERIALS**

## Introduction

Drainage chemistry prediction, like any environmental inquiry, requires thorough characterization of the materials and a good understanding of the contributing biological, chemical and physical properties and processes, possible environmental impacts and the investigation methods. Accurate, clearly defined terminology must be used to ensure that results are not misinterpreted. The use of consistent test procedures and terminology will allow comparisons to be made among sites or with previously collected data.

Clearly understood definitions and accepted meanings are critical to the development of any field of scientific inquiry. Clear definitions allow unambiguous testing of the existing concepts and theories and provide the foundation for future development. Properties and processes may be defined according to their composition, form of action or contextually according to their relative properties or performance.

Clear definitions are especially critical in drainage chemistry prediction due to the public and international nature of the work. Drainage chemistry prediction is now being conducted by mines throughout the world and many jurisdictions and organizations are sponsoring research programs. Effective communication will enable the review of methods, theories and data. Presently, there is little consistency in terminology even between practitioners within the same jurisdiction. Even larger variations exist between different geographical areas. This glossary will serve to enable better communication among practitioners and reviewers within and between jurisdictions.

A number of problems must be overcome in order to develop consistent, well defined terminology. The large amount of detail and the technical nature of drainage chemistry prediction pose major challenges for those attempting to communicate the results of their work. Other obstacles to effective communication include: the lack of standard definitions for much of the terminology; the multidisciplinary nature of the subject; the complexity of concepts such as neutralization potential; the large amount of jargon and acronyms; the difficulty in measuring key parameters such as mineralogy; and the common use of vague or misleading terms such as paste pH.

This glossary borrows heavily from and/or adapts terms from various fields of study, a reflection of the multidisciplinary nature of drainage chemistry prediction. Readers should note that the objective here is not to produce a dictionary. Wherever possible, only one definition is given. Where there is more than one definition, practitioners and reviewers should clearly specify which definition is being used.

Part of the reason for the large number of definitions ascribed to the terms used in drainage chemistry prediction has been the lack of clarity regarding many of the key concepts. More accurate and precise terminology requires distinction between:

- different phenomena (e.g. the distinction between *acid generation* and *net acidic drainage*);
- measurements made after different types of sample preparation (e.g. paste pH versus rinse pH) or different laboratory procedures (e.g. the various forms of *acid potential*); and
- laboratory measurements and the phenomena in the field that they may or may not be used to predict.

An example of this is the provision of separate terms and definitions for *effective neutralization potential*, *unavailable neutralization potential* and the various laboratory measurements of *neutralization potential*. A disadvantage of increased precision in terminology is the proliferation of cumbersome prefixes and acronyms. This is an unavoidable consequence of increased understanding and recognition of the large number of contributing factors. Possible measures to reduce the length of terms include the use of acronyms such as NP and ARD and the creation of new terms. Common acronyms and units of measure are outlined at the start of this glossary.

A good example of an entity for which various disciplines have different names and slightly different definitions is “the unconsolidated inorganic and organic matrices produced by *weathering*, *sediment* deposition, biological accumulation, human or volcanic activity and occurring on the planet earth's surface.” Existing terms include: Quaternary *sediments*, *surficial materials* and *unconsolidated materials* (geology), *soil* and *earth* (engineering) and *overburden* (soil science). The term selected for the glossary was *non-lithified surficial material*. The term *surficial material* was not selected because it emphasizes position rather than composition, creating possible confusion regarding the classification of *bedrock* outcrops and exposed mine walls. The term *overburden* creates similar confusion and is used in coal mining to describe both *bedrock* and *non-lithified surficial materials* overlying a coal seam. The term *sediment* has a depositional component to its definition, and is used in the glossary as a subset of *non-lithified materials*. A wide range of definitions are possible for the term *soil*. In the glossary, the term *soil* is given its *soil science* definition rather than the definition used in *geotechnical engineering*.

Where possible, definitions should include criteria that distinguish the term from other similar terms. This is especially important where categories exist along a continuum. While a number of definitions include quantitative criteria and boundary conditions (e.g. *water table*: the elevation at which the fluid pressure is equal to atmospheric pressure in an unconfined aquifer with horizontal flow), many do not. From their definitions, it is difficult to draw a line between *bedrock* and *non-lithified surficial material*. At present, there are no quantifiable distinguishing criteria. *Bedrock* includes porous, *clay* rich materials lacking strength and hardness and readily *slaking* in water. *Non-lithified material* includes compact, strongly cemented, fluvial materials which resist slaking and are both strong and hard.

The problem of where to set boundaries is also encountered in defining various forms of hydrothermal alteration. Traditional qualitative definitions are provided for prefixes such as phyllic and propylitic in a separate hydrothermal alteration section at the end of the glossary. However, the glossary supports the recommendations of Thompson and Thompson (1996) that hydrothermal *alteration* should be primarily defined by the mineral assemblage. Any description of mineralogy such as hydrothermal alteration should include an outline of the methods used in mineral identification.

Where no standard definition was available, with the assistance of our technical advisors, one was created from the accepted meaning and common practice.

## References

Thompson, A.J.B. and J.F.H. Thompson (eds.) 1996. Atlas of Alteration: a Field and Petrographic Guide to Hydrothermal Alteration Minerals. GAC Mineral Deposits Division. p. 119.

### Units of Measure - Symbols

Celsius	°C
Centimeter	cm
Cubic meter	m <sup>3</sup>
Gram	g
Grams per liter	g/L
Grams per tonne	g/t
Greater than	>
Kilo-tonne	kt
Kilogram	kg
Kilograms per tonne	kg/t
Less than	<
Litre	L
Meter	m
Metric tonne	t
Microgram	µg
Micrometer (micron)	µm
Milligrams per litre	mg/L
Millimeter	mm
Nephelometric Turbidity Units	NTU
Not applicable	n/a
Ounce	oz
Ounce per tonne	oz/t
Parts per billion	ppb
Parts per million	ppm
Parts per thousand	ppt
Percent	%
Plus or minus	±
Pounds per square inch	psi
Second	s
Ton (imperial)	ton
Tonne (metric)	t
Year (annum)	yr, a



**Acronyms**

ABA	Acid Base Accounting
AD	Acidic Drainage
AG	(Presently) Net Acidic or ARD Generating
AMD	Acid Mine Drainage
AP	Acid Potential or Acid Generation Potential
ARD	Acid Rock Drainage
MEND	Mine Environment Neutral Drainage
ML/ARD	Metal Leaching / Acid Rock Drainage
NNP	Net Neutralization Potential
NP	Neutralization Potential or Acid Neutralization Potential
Non-PAG	Not-Potentially Net Acidic or Not-Potentially ARD Generating
PAG	Potentially Net Acidic or Potentially ARD Generating
PWQO	Provincial Water Quality Objectives

Parenthetical notation can also be used to indicate the measurement from which the parameter was derived. Standard strong acid static bulk NP procedures can be indicated as NP(Sobek), NP(Modified) and NP(BCR), for the Sobek, Modified and BC Research methods, respectively. NP values calculated from the weak acid addition required to reach a prescribed pH can be indicated by the pH endpoint, e.g. NP(pH6).

Another example is the provision of parenthetical notation to indicate whether data is from the field or laboratory. NP data derived from humidity cells that became acidic can be reported as NP(hc), with NP(field test) for data from field test piles.

## Terms Pertaining to Drainage Chemistry and Weathering of Sulphidic Geologic Materials

**Abiotic Factors** - Environmental influences that arise from non-living entities, such as climate.

**Absorption** - The uptake of a gas by a solid or a liquid, or a liquid by a solid. Absorption differs from *adsorption* in that the absorbed substance permeates the bulk of the absorbing substance. Also used to describe uptake by plants and animals.

**Acid** - A substance that can donate a hydrogen ion to another substance. See also *base*.

**Acid Generation Potential (AP)** - See *acid potential*.

**Acid Generation** - Production of *acid*, irrespective of its later fate; the resulting *pH* of the pore water or whether the material is *net acidic* or *neutral*. The generated *acid* may dissolve, be *neutralized* or form acid salts that dissolve at a later time. The primary sources of *acid generation* in sulphidic geologic materials are *sulphide oxidation*, any associated metal *hydrolysis* and the *dissolution* of the *acidic* products of previous *sulphide oxidation*. Other *oxidation* reactions that may generate *acid* include the decomposition of organic matter and the *oxidation* of ammonium from blasting powder and cyanide decomposition. *Acid generation* should not be confused with the generation of *acidity* or generation of *acidic drainage* or *ARD*. The generation of *acidic drainage* additionally requires drainage and for *acid generation* to exceed *acid neutralization*. See *ARD generation*.

**Acid Mine Drainage (AMD)** - See *acid rock drainage*.

**Acid Neutralization** - Increasing the *pH* of *acidic drainage* to *near-neutral* levels or consuming *acidity* through reactions in which the hydrogen ion of an acid and the hydroxyl ion of a base combine to form water, the other product being a salt. Note that consumption of *acidity* may not necessarily raise the *pH* to *near-neutral* levels. See also *neutralization*, *buffering capacity* and *acid neutralization potential*.

**Acid Potential (AP)** - The total *acid* a material is capable of generating, including *acid* that dissolves, is *neutralized* and forms acid salts. Estimation of the AP and its use to estimate the potential future net drainage pH is an integral part of *Acid Base Accounting* (Chapter 14). Accurate data interpretation requires an understanding of the physical and geochemical conditions, potential limitations of the analytical procedures, the identity, location and reactivity of the contributing minerals and external *acid* and *acidity* inputs (Chapter 12). Unless otherwise specified, the assumption is that all geologic constituents are exposed to oxidizing weathering conditions and there is sufficient time for complete oxidation of the sulphide minerals. The procedures used to derive AP should be clearly identified. Analyses of sulphur species are used to estimate the acid potential (AP) from the oxidation of sulphide minerals and the *dissolution* of the *acidic* sulphate products of previous *sulphide oxidation*. AP is typically reported in units of kg CaCO<sub>3</sub> equivalent/tonne. The AP of sulphide minerals whose oxidation will generate the same acid per unit sulphur as pyrite is calculated by multiplying their % *sulphide-sulphur*, or another more accurate or equivalent % sulphur fraction, by 31.25.

Correction of the AP calculated in this manner may be required where there are significant concentrations of sulphide minerals that differ in their AP per unit sulphur or if there significant contributions of other non-acid generating forms of sulphur. Sulphur *mineralogy*, *sulphide mineral chemistry* and the concentration of common *sulphide* trace elements, such as As, Cu, Mo, Pb and Zn, can be used to estimate the concentration of iron and non-iron *sulphide-sulphur* and other forms of *sulphide-sulphur*. The AP from the *dissolution* of the acidic products of previous *sulphide oxidation* can be estimated from the *acidity* dissolved in *rinse tests* with a water to solid ratio that exceeds the solubility limits of the acid salts (Chapter 11). Solute drainage chemistry (especially *rinse pH*) can be used to identify the presence of acid salts. Sample mineralogy (Chapter 17) can be used to identify and estimate the concentration of residual acidic secondary minerals, such as the acid sulphates jarosite and alunite. In samples where a *near-neutral* pH indicates an absence of the *acidic* products of previous *sulphide oxidation*, the *sulphide-sulphur* plus *del %S* provides a conservative measure of AP, while avoiding large errors as a result of the inclusion of basic *sulphates* and organic sulphur. *Del %S* (unidentifiable sulphur forms) should be included in the AP calculation to ensure *acid generating* elemental or thiosulphate sulphur are included. *Total sulphur* may be substituted for *sulphide-sulphur* if there is no *sulphate* and *organic sulphur*. See *acid generating potential* and *effective, insufficiently reactive* and *unavailable acid potential*.

**Acid Rock Drainage (ARD)** - Acidic *pH drainage* derived from materials with an insufficient capacity to neutralize the acidic products of *sulphide* and elemental sulphur *oxidation* and the dissolution products of acidic minerals and amorphous materials. ARD is produced when the *NP* is no longer capable of maintaining *neutral pH* conditions in a measurable volume of drainage. In the context of mining, may be referred to as *acid mine drainage* (AMD). See also *acid generation*, *ARD onset* and *effective neutralization potential*.

**Acid Base Accounting (ABA)** - A series of chemical analyses and calculated values (Chapter 14) used to estimate the magnitude of the *acid generation potential* (AP, Chapter 12) and *acid neutralization potential* (NP, Chapter 13) of a *sample* and its present and potential future net drainage pH. ABA includes the most common *static tests* used in the prediction of *acid rock drainage*. Uses of ABA data include: 1) an initial coarse estimation of the present and potential future net drainage pH; 2) part of the information used in a more refined, site specific prediction of the present and potential future net drainage pH; and 3) operational characterization of the present and potential future net drainage pH of excavated material and exposed surfaces, based on refined, site specific prediction in 2 above. *Kinetic tests*, *mineral* identification and detailed elemental analysis are required for more refined, site-specific prediction. Accurate prediction of the potential future net drainage pH from the ABA data requires an understanding of the analytical procedures, the future physical and geochemical conditions, external inputs and the identity, location and reactivity of the contributing minerals. The analytical procedures, the number of tests and the interpretation of the analytical data should all be clearly identified since there is considerable variation in sample preparation. See also *acid generation*, *neutralization potential* and *static NP procedures*.

**Acid Leachable Sulphate-Sulphur** - A measure of *sulphate-sulphur* in a sample, except that which occurs as *barite*. Assumed to be non-acid generating in neutral pH samples. Acid pH samples may include acidic sulphate species such as jarosite and alunite. One of a series of sulphur analyses that are a part of *Acid Base Accounting*, expressed as % S. See also *total sulphate-sulphur* and *barium sulphate-sulphur*.

**Acid Neutralization Potential (NP)** - The total acid a material is capable of *neutralizing*. Estimation of the NP and its use to estimate the potential future net drainage pH is an integral part of *Acid Base Accounting* (Chapter 14). Accurate estimation of the acid neutralization potential requires an understanding of the physical and geochemical conditions, external inputs, potential limitations of the analytical procedures and the identity, location and reactivity of the contributing minerals (Chapter 13). Unless otherwise specified, the assumption is that all geologic constituents are exposed to oxidizing weathering conditions and there is sufficient time for complete oxidation of the sulphide minerals. Analyses used to estimate the acid neutralization potential (NP) include: *bulk NP* procedures using strong acid (Sobek, Modified Sobek) and weak acid (Lapakko method) and carbon analyses used to calculate the *carbonate-NP*. Measurement of *bulk-NP* and *carbonate-NP* are standard ABA analysis requirements in British Columbia. The procedures used to derive NP should be clearly identified. NP is typically reported in units of kg CaCO<sub>3</sub> equivalent/tonne. See also *neutralization*, *buffering capacity* and *acid neutralization*.

**Acidic Drainage (AD)** - A general term applied to any *drainage* with an *acidic pH* or excess *acidity*. Note that depending on the redox or pH end point for the acidity titration, drainage with a *near-neutral* pH could contain excess acidity (e.g. elevated concentrations of Fe<sup>2+</sup> or Zn<sup>2+</sup>). However, once the ferrous iron oxidizes and precipitates or the zinc ions precipitate, the pH will decrease. See *pH*, *acidic pH* and *acid rock drainage*.

**Acidic pH** - By a strict chemical definition, any pH < 7 is considered acidic. This glossary defines a *near-neutral pH* as between 6.0 to 8.0 and an acidic pH as less than 6. The point of concern regarding a decrease in pH is the site specific pH value at which there is a significant increase in the weathering or solubility of the contaminant(s) of concern. See also *net-neutral* and *alkaline pH*.

**Acidic** - See *acidic pH* and *acidic drainage*.

**Acidity** - A measure of the capacity of a solution to *neutralize* a strong base. A measure of excess hydrogen ions, plus dissolved species, such as trivalent aluminum and hydroxyaluminum complexes, capable of producing excess hydrogen ions. Analytically determined by *titration*. The analytical value will depend on the pH end point for the *titration*. The *acidity* of a solution generally increases as its *pH* decreases. However, solutions with similar pH values may have very different acidities. See also *alkalinity*.

**Active Chemical Treatment** - Processes in which chemicals or natural compounds are added to contaminated *drainage* to improve water quality. This can vary from relatively simple batch treatment to a sophisticated computerized treatment plant with multiple additives and detailed process monitoring and control. Improvements in water quality usually result from the *acid neutralization* and the precipitation or co-precipitation of the *deleterious contaminants*. See also *treatment sludge*.

**Acute Toxicity** - Lethal effects. See also *chronic toxicity*.

**Acute Toxicity Tests** - Measure of whether an organism can survive exposure to the test solution for a specified period of time. See also *acute toxicity*, *bioassay* and *chronic toxicity*.

**Adit** - Horizontal or near horizontal passage driven from the surface into the side of a mountain or hill to access workings or *dewater* the *mine*. See also *drift*, *crosscut*, *level* and *portal*.

**Adsorption** - Process by which atoms, molecules or ions are retained on the surfaces of solids by chemical or physical binding. See also *absorption*.

**Aerial** - In the presence of the *earth's* atmosphere. See also *aerobic* and *sub-aerial*.

**Aerobic** - In the presence of oxygen. See also *aerial* and *anaerobic*.

**Alkaline Drainage** - A general term applied to any *drainage* with an *alkaline pH* or excess *alkalinity*.

**Alkaline** - See *Alkaline pH* and *alkaline drainage*.

**Alkaline pH** - By a strict chemical definition, any  $\text{pH} > 7$  is considered alkaline. This glossary defines a *near-neutral* as  $\text{pH} 6.0$  to  $8.0$  and an alkaline  $\text{pH}$  as  $> 8.0$ . Depending on government guidelines, contaminant availability and solubility, and intended usage of the water, the maximum permitted  $\text{pH}$  values in water courses receiving mine discharge varies between  $8.5$  and  $9.5$ . See also *acidic*, *basic* and *alkaline pH*.

**Alkalinity** - A measure of the capacity of a solution to *neutralize* a strong acid. Analytically determined by *titration*. The analytical value will depend on the  $\text{pH}$  end point for the *titration*. A measure of excess bicarbonate/*carbonate* and/or hydroxide in solution or of a solid material's ability to produce an excess. The *alkalinity* of a solution generally decreases as *pH* decreases. However, solutions with similar  $\text{pH}$  values may have very different alkalinities. See also *acidity*.

**Alkalinity Amendment** - Material that dissolves in water to give bicarbonate/*carbonate* and/or hydroxide ions and *neutralizes* some or all of the *acidity* present in *acidic drainage*.

**Alteration** - Changes in the chemical or mineralogical composition of a *rock*, generally produced by *weathering* or *hydrothermal* solutions.

**Aluminosilicates** - Compounds containing silica, aluminum and oxygen as main constituents. See also *silicates*.

**Amorphous** - Substances lacking detectable crystal structure or order. Common occurrences include coatings and flocs of iron and aluminum oxyhydroxides and organic matter. Lime treatment of acidic drainage often produces amorphous iron oxyhydroxides flocs. See also *mineral*.

**Amphoteric** - A substance that can react as either an *acid* or *base*.

**Anaerobic (Anoxic)** - An *environment* without free oxygen. See also *aerobic*.

**Anhydrous** - To exist in a dehydrated state. See also *hydration*.

**Anomaly** - Any departure from the norm which may indicate the presence of mineralization in the underlying *bedrock*. In geophysics and *geochemistry*, an area where the property being measured is significantly higher or lower than the larger, surrounding area.

**Anoxic Limestone Drain** - A *limestone* bed designed to receive and *neutralize acidic drainage* with an oxygen consuming or relatively impervious cover to minimize oxygen entry. The incorporation of *anaerobic* conditions is to prevent iron precipitation and the resultant armouring or “blinding” of the *limestone*.

**Anthropogenic** - Formed by man.

**AP** - See *acid potential*.

**Aqua regia** - A mixture of two concentrated acids, 1 part nitric (HNO<sub>3</sub>) to 3 parts hydrochloric (HCl) acids.

**ARD Onset** - The first appearance of *acidic pH* values in *drainage*. Detection sensitivity will depend on the monitoring locations and frequency. Zones of pervasive acid *weathering*, with significant *ARD generation*, may occur locally or internally within a particular *mine component* prior to *ARD* detection or persistent *acidic pH* values occurring at the monitoring point.

**Assay** - To determine the size or composition (Verb). The mass of a *metal* contained within a *sample* of *rock* (Noun). Assay results are determined by chemical and analytical analyses and are usually expressed in one of the following units: ppm, ppb, g/t or oz/t.

**Attenuate** - Reduce in magnitude. Reductions in *loading* result from processes like precipitation, *absorption* and *adsorption*. Reductions in concentration also result from *dilution*.

**Autogenous Grinding** - A method of *grinding rock (ore)* into a fine powder using large pieces or pebbles of the *ore* being ground as a grinding media instead of conventional steel balls or rods. See also *ball mill* and *semi-autogenous grinding*.

**Backfill** - Material used to fill voids created by mining an *ore body* or coal deposit. Due to the expanded volume, only a portion of the originally excavated material can be used as *backfill*. See also *hydraulic backfill*.

**Ball Mill** - A cylindrically or conical shaped steel container which is partially filled with steel balls and crushed *ore* and which rotates about its own axis. The rotation causes the balls to cascade, which in turn grinds the *ore*. See also *autogenous* and *semi-autogenous grinding*.

**Base** - A substance that can donate a hydroxide ion to another substance.

**Base Metal** - A general term applied to relatively less expensive *metals*, such as copper, zinc, nickel, lead, tin, iron and aluminum, which based on cost can be distinguished from *precious metals* (gold, silver, platinum and palladium) and the alkali and alkali earth metals. Costs vary according to supply and demand. In the past, molybdenum has been more expensive than silver. Base metals are the source of most metal contamination problems. See also *heavy metal*.

**Baseline Information** - Information gathered prior to disturbance. Used to define pre-mining conditions.

**Bedrock** - A general term for solid masses of *rock*. *Bedrock* can be exposed at the surface or buried beneath *non-lithified materials*.

**Bench** - A relatively flat, horizontal surface, elevated within an *open pit* or a *waste rock dump* or natural formation. Commonly referred to by its elevation or depth.

**Bench Height** - The vertical distance between adjacent benches in an *open pit* or *dump*. Measured from the *toe* of one *bench* to the crest of the connecting slope.

**Bioleaching** - A process in which the *metals* are dissolved with the aid of bacteria. Used for recovering *metals* from refractory or *low grade ores*. See also *heap leach*.

**Bioaccumulation** - A process of concentration or accumulation within an organism. May take place at the cellular, body organ or whole organism level. Pathways include simple diffusion into cells or tissues from the water column or substrate, or through food consumption. Usually used with reference to *contaminant metals* which may bioaccumulate, including mercury, cadmium and lead. See also *absorption*, *adsorption* and *bioavailability*.

**Bioavailability** - A property of a substance which makes it accessible and potentially able to affect an organism's health. Depends on site specific conditions.

**Blast hole** - A hole drilled for the placement of explosives. The usual purpose of the blast is to break apart bedrock, permitting its excavation.

**Blending** - In the context of sulphidic drainage chemistry, *mitigation blending* refers to the co-deposition of potentially net acid (PAG) and net neutral mine wastes (Non-PAG). The objective in *blending* is generally to create a composite material in which the acid produced by the PAG waste material is neutralized by Non-PAG materials, with a consequent precipitation of the majority of the released *metals* as *secondary minerals*.

**Buffering Capacity** - The ability of a substance to resist an increase or decrease in *pH*. See also *neutralization*.

**Bulk Neutralization Potential** - *Static* laboratory measurement of the capability of a *sample* to neutralize applied acid. Determined by means of relatively simple chemical tests. The resulting data does not consider the mineralogical and elemental sources or other factors that might reduce the field effectiveness of the measured NP. Test procedures vary according to the strength and volume of acid and the value to which the pH is lowered. In the Sobek test, a fizz test is used to determine the strength and volume of acid. In other tests, acid is added incrementally until a specified acidic pH value is reached and maintained. In some cases, the NP is determined by the amount of acid required to reach the designated pH (e.g. BC Research and Lapakko weak acid tests). In the Sobek and the Modified Sobek procedures, the NP (the amount of acid neutralized by the sample) is established by titrating the reacted solution with a strong base to determine the amount of acid remaining. Both bulk and *carbonate NP* measurements are required for *Acid Base Accounting* in British Columbia. The most commonly used bulk NP tests are the BC Research, Sobek or Modified Sobek procedures, tests in which strong acid is added. See also the *discussion of acronyms*.

**Bulk Sample** - A large *sample* of mineralized rock, frequently hundreds or thousands of tonnes and selected in such a manner as to be representative of the critical properties of the potential *ore body*. Bulk samples are used to verify *ore grades* and determine *metallurgical* characteristics.

**Bulkhead** - A tight partition of wood, *rock* or concrete used to prevent the movement of *backfill*, gas, fire and/or water in *underground workings*.

**Carbonate** - A compound or mineral containing the  $\text{CO}_3^{2-}$  ion. The most important carbonate minerals from the perspective of ML/ARD are the hexagonal carbonates *calcite* ( $\text{CaCO}_3$ ), *dolomite* [ $\text{Ca,Mg}(\text{CO}_3)_2$ ], *magnesite* ( $\text{MgCO}_3$ ), *ankerite* [ $\text{Ca}(\text{Mg,Fe})(\text{CO}_3)_2$ ], *siderite* ( $\text{FeCO}_3$ ), *rhodocrosite* ( $\text{MnCO}_3$ ) and *smithsonite* ( $\text{ZnCO}_3$ ), between which there is extensive solid solution and the basic carbonates *malachite* [ $\text{CuCO}_3\text{Cu}(\text{OH})_2$ ] and *azurite* ( $2\text{CuCO}_3\text{Cu}(\text{OH})_2$ ). Carbonate minerals are important in ARD neutralization. The trace metal carbonate minerals are important sources and sinks of soluble metals. Note that calcium and magnesium carbonates are very effective in neutralizing acidity. Iron and manganese provide no net neutralization under oxidizing conditions.



**Carbonate Neutralization Potential** - The maximum *neutralization* capacity that would be available if all the *carbonate* minerals in the sample reacted like *calcite*. Determined by means of relatively simple carbon [NP(CO<sub>3</sub>-C)] or carbon dioxide [NP(CO<sub>3</sub>-CO<sub>2</sub>)] assays. Unless it is corrected, the data does not consider the differences in carbonate mineralogy or any other factors that might reduce the effectiveness of this NP measurement. An important correction is for the contribution of non-acid neutralizing Fe and Mn carbonates to the measured carbon or carbon dioxide, i.e. [NP(CaMgCO<sub>3</sub>-CO<sub>2</sub>)]. Measurements of both *carbonate NP* and bulk NP are analytical requirements of *Acid Base Accounting* in British Columbia. The simplest analytical procedure is an *assay* for total carbon if inorganic carbonate is the dominant form of carbon. In materials containing organic matter, like coal, an *assay* of total inorganic carbon is required (NP[CO<sub>3</sub>-TIC]). The percentage of carbon is multiplied by 83.4 to obtain the kg CaCO<sub>3</sub> equivalent/tonne. XRD and/or sub-microscopic procedures can be important to determine the contribution of Fe and Mn carbonates to the measured carbon or carbon dioxide. See also *static NP procedures*.

**Catchment Area** - A recharge area or *drainage* basin and all areas that contribute water to it. The area that contributes water to a particular watercourse; a watershed.

**Categories of drainage chemistry** - Commonly based on *pH*. See also *acidic drainage*, *near-neutral mine drainage* and *alkaline drainage*.

**Chemical Equilibrium** - A chemical condition in which the rates of forward and reverse reactions are equal and the concentrations of reactants and products do not change with time. One of two major chemical conditions affecting drainage chemistry. See also *kinetic effect*.

**Chip Sample** - A series of small pieces of *rock* taken in a continuous line across a *rock* exposure or at uniformly distributed intervals. May also refer to a *sample* taken from the *rock* fragments created in drilling.

**Chronic Toxicity** - A reduction in growth, reproduction and/or development or the mutation of an exposed organism. Chronic toxicity is also referred to as sub-lethal. See also *acute toxicity*.

**Chronic Toxicity Tests** - A measure of reduction in growth, reproduction and/or development, or the mutation of an organism exposed to a test solution over a specified time period. See *acute toxicity tests*.

**Classifier** - Mineral processing equipment which separates *minerals* according to size and density, including grizzlies, screens, cyclones and other mechanical devices.

**Clay Mineral** - Phyllosilicate *mineral*, such as biotite, muscovite, smectite and kaolinite.

**Clay Sized** - *Particles* < 2 mm in diameter. See also *soil sized*.

**Cleaner Stage** - A term applied to measures used to upgrade the *concentrate* produced in the rougher and scavenger circuits. The term cleaning may also be used for the processes used to reduce the ARD potential of rougher *tailings*. Processes may include regrinding and selective flotation of waste iron *sulphides*. See also *flotation circuit* and *rougher* and *scavenger stages*.

**Cleaner Tailings** - *Tailings* generated in the cleaner stage(s) of mill *processing*, from either upgrading the concentrate or measures to reduce the ARD potential of the main *tailings* mass. Cleaner *tailings* often have a high ARD potential.

**Coarse Fragment** - *Particles* > 2 mm in diameter including gravel, stones, cobbles and boulders. See also *soil sized*.

**Coarse Refuse** - Coarse waste product of coal *wash plant*. See also *fine refuse*.

**Colluvium** - Materials that reached their present positions as a result of direct, gravity induced movement involving no agent of transportation such as water or ice, although the moving material may have contained water or ice. Generally consist of *massive* to moderately well stratified, non-sorted to poorly sorted *sediments* with any range of *particle* sizes from clay to boulders and blocks. The character of a colluvial deposit depends upon the nature of the material from which it was derived and the specific process whereby it was deposited. See also *talus slope*.

**Comminution** - Reduction in particle size. See also *crush* and *grind*.

**Compaction** - A process resulting in a reduction in volume. The change typically results from externally applied loads, creating tighter packing of the solid particles. In fine soils in particular, this requires an egress of pore water. Greater compaction often results in increased *consolidation*.

**Composite Sample** - A *sample* created by combining different fractions (sub-samples). Sub-samples can be collected at different times or from different locations.

**Concentrate** - The product of the milling process, enriched in the valuable *metal* or *mineral* relative to the *ore*; typically a fine powder. The waste product of the concentration process is typically discarded as *tailings*.

**Concentrator** - A milling plant that produces a *concentrate* of the valuable *minerals* or *metals* using processes such as *cyanidation* and *flotation*. Further treatment is required to recover the pure *metal*. See also *mill*.

**Conductance** - The ease with which a material transmits an electric current. A high conductivity indicates a solution with a high charged ion content, a property sometimes used to detect ARD.

**Consolidation** - A process by which loose, soft or liquid *non-lithified* materials become firm and coherent. Consolidation typically results from tighter packing with greater inter-particle cohesion or friction and less pore water holding particles apart. See also *compaction*.

**Contaminant** - Introduced *species* or materials which were either not previously present or were present in lesser amounts. The introduction of contaminants may be beneficial or make something harmful or otherwise unfit for use. The most important contaminants species in *metal leaching* and *acid rock drainage* are *metal* and *metalloid* elements which are often present in large enough amounts to have a deleterious effect on flora and fauna. Below certain amounts *contaminant species* (for example, nutrients) may be desirable constituents. Synonymous with the term pollutant. See also *deleterious contaminants*.

**Core** - The long cylindrical piece of rock, about 5-10 cm or more in diameter, recovered by diamond drilling.

**Country Rock** - A term applied to *rocks* intruded by an *igneous intrusion* or surrounding a *mineral deposit*.

**Cross section** - A profile or vertical section used to illustrate geologic information, often obtained from diamond drilling. See also *plan view*.

**Crush** - Reduce in particle size by squeezing or forcing under pressure. See *crusher* and *grind*.

**Crusher** - Equipment for reducing the *particle* size of *rock* or other materials; includes gyratory, jaw, roll and cone *crushers*. Commonly the first step in milling. See also *crush* and *grind*.

**Cumulative Effect** - The consequence of simultaneous or successive impacts and additions occurring within a defined area or from a prescribed set of activities. The cumulative effects of a *mine* are the combined effects of all *mine* components and from all mining activities.

**Cut-Off Grade** - The lowest *grade* of mineralized material in a given deposit that qualifies as *ore*. Used in the calculation of *ore reserves*.

**Cyanidation** - A method of extracting exposed gold or silver grains from crushed or ground *ore* by dissolving it in a weak solution of sodium or calcium cyanide. Also known as cyanide *leaching*. May be carried out in tanks inside a mill or in heaps of *ore* outdoors. See also *heap leach*.

**Decline** - Downward sloping *underground working*. Includes *adits* and passages connecting different *levels* (ramps).

**Deionized Water** - Chemically or electrochemically purified water used in chemical analysis to avoid contamination of the materials being tested.

**del %S** - *Total sulphur* minus all other measured sulphur species such as *sulphide-sulphur*, *total sulphate-sulphur*, and *organic-sulphur*. The portion of *total sulphur* not identified by the more specific sulphur analyses carried out in *Acid Base Accounting*. Reported in units of % S. Represents errors and omissions in measurements of sulphur species. This might include thiosulphates or elemental sulphur. In the absence of further characterization, this fraction should be conservatively assumed to be acid generating *sulphide-sulphur*.

**Deleterious Contaminant** - Contaminant species which potentially can cause a reduction in quality or performance. Deleterious contaminants above certain concentrations or loadings may make a substance harmful or otherwise unfit for use. The most important contaminants in *metal leaching* and *acid rock drainage* are *metal* and *metalloid* elements which are often present in large enough amounts to have a deleterious effect on flora and fauna. See also *chronic* and *acutely toxicity tests*.

**Desulphurized** - Material (commonly *tailings*) that has had sulphur removed.

**Development** - Work carried out for the purpose of opening up or exposing a *mineral* deposit. Includes the removal of *non-lithified material*, *rock overburden*, sinking a *shaft*, crosscutting, drifting, ramping and raising.

**Dewatering** - The process of removing water from an underground *mine* or *open pit*, or from the surrounding *rock* or *non-lithified materials*. The term is also commonly used for the reduction of water content in concentrates, tailings and treatment sludges.

**Diamond Drill** - A rotary type of rock drill in which cutting is done by abrasion rather than percussion. The cutting bit is set with diamonds and is attached to the end of long hollow rods through which water is pumped to the cutting face. The drill cuts a core of rock that is recovered in long cylindrical sections, two centimeters or more in diameter.

**Digestion** - The process of dissolving and breaking down chemical compounds and *minerals* into an aqueous solution. See *aqua regia*.

**Dilution** - To diminish the concentration by mixing one mass with another. For example, the mixing of one flow of water with another flow to obtain a flow with an intermediate aqueous concentration. This process is used to reduce the concentration of *metals* or other potentially *deleterious contaminants* in the more concentrated flow. Dilution may take place by diffusion and dispersion. Dispersion mechanisms include turbulent flow in a river or creek, or currents and wind generated mixing in lakes.

**Discharge Limits** - The maximum allowable concentrations of *contaminants* and/or volumes of discharge. Conditions under which discharges may take place.

**Dissolution** - The process whereby solid matter dissolves in a liquid. For example, the dissolving of limestone (calcium *carbonate*) in rain and *groundwater*. See also *solubility*.

**Diversion Ditch** - A channel used to divert clean water away from a mine component. An important part of water management at most *mines*. See also *collection ditch*.

**Drainage Chemistry** - The concentrations of dissolved components in drainage, including element concentrations, chemical species and other aqueous chemical parameters.

**Drainage** - The manner in which the waters of an area exist and move, including surface streams and *groundwater* pathways. A collective term for all concentrated and diffused water flow.

**Drift** - Horizontal or near horizontal *underground working* or *adit*, in or parallel to *ore*. Follows along the length of a *rock* formation, as opposed to a *crosscut*, which crosses the *rock* formation.

**Drill Core** - See *core*.

**Dump** - A man made pile, heap or accumulation of broken *ore*, *rock* or *non-lithified material*. Term commonly used for piles of *waste rock*.

**Dyke (Dike)** - **1.** An *earth*-filled embankment or dam. **2.** A tabular body of *igneous rock* that cuts across the *rock structure* or cuts *massive rocks*.

**Earth** - **1.** Inorganic *non-lithified material*. **2.** The planet we live on.

**Ecology** - The study of relationships between organisms and their *environment*. Ecological developments include the introduction, growth and change in plant and animal inhabitants. See also *ecosystem*.

**Ecosystem** - A community of organisms and their immediate physical, chemical and biological *environment*.

**Effective Acid Potential** - The fraction of the AP that is physically available and sufficiently *acid generating*. Depends on the *drainage chemistry*, especially the *pH*, *minerals* contributing to the measured *acid potential* (AP) and their elemental composition, physical occlusion and reaction rate. See also *unavailable acid potential* and *insufficiently reactive acid potential*.

**Effective Neutralization Potential** - The fraction of the NP that will neutralize internal and external acid inputs maintaining a *drainage pH* of 6.0 or above. Depends on various factors including the type of material (e.g. tailings, waste rock or mine wall), environmental conditions (e.g. atmospheric CO<sub>2</sub> content, *drainage chemistry*, leaching rate and temperature), scale (e.g. whether the material is part of a *mine component*, a test pad or a humidity cell), the *minerals* with *neutralization potential* (NP), the rate of in situ *acid generation* and/or external acid inputs in *drainage*, the *weathering* rate of the potentially neutralizing *minerals*, the physical occlusion of *minerals* in *coarse fragments* or *rock walls* and the fact that the dissolution of some *carbonate minerals* might produce excess *alkalinity* in drainage. See also *bulk*, *carbonate* and *unavailable neutralization potential*.

**Effluent** - Water discharged into the *environment* from a man made structure. For example, the *drainage* products from a water treatment plant.

**Eh** - An electrical potential which is a measure of the redox or *oxidation/reduction* potentials. Reported in units of millivolts (mV) relative to the standard hydrogen electrode. See also *pe*.

**Environment** - The interrelated physical, chemical, biological, social, spiritual and cultural components that affect the growth and development of living organisms. See also *minesite environment*.

**Equilibrium** - See *chemical equilibrium*.

**Erosion** - The detachment and subsequent removal of either *rock* or surface material by wind, rain, wave action, freezing, thawing and other processes. See also *mass wasting* and *gully erosion*.

**Euhedral** - Term used to describe a crystal displaying well formed and regularly developed crystal faces.

**Evaporation** - The physical process by which a liquid is changed into a gas. See also *evapotranspiration*.

**Evapotranspiration** - The loss of moisture to the atmosphere due to *evaporation* and *transpiration* by vegetation.

**Fabric** - **1.** The spatial and geometrical configuration of all those components that make up a *rock* including texture, *structure* and preferred orientation. **2.** The spatial arrangement of solid *particles* and voids in *unconsolidated non-lithified materials* (for example, *till*).

**Face** - Any surface on which mining operations are active. The site of progressive excavation or deposition, commonly vertical or steeply sloping. The end of an active *drift*, crosscut or slope in an underground mine. The working face in an *open pit*. A *dump* slope that is being pushed out as a *waste rock dump* expands. See also *bench*.

**Facies** - A *rock* unit or group of *rock* units that exhibit lithological, mineralogical, sedimentological and paleontological characteristics which enable them to be classified as distinct from another *rock* unit or group. Usually reflecting its mode of origin.

**Fault** - A *fracture* or fracture zone in *rock* strata resulting from strain and with observable displacement.

**Feasible** - Capable of being done, used or dealt with successfully. In order to be feasible, a method must be compatible with the mitigation objectives and site specific mining and environmental constraints and must not entail excessive costs.

**Field Test Pads** - Tests run to show progress of *weathering* and resulting *drainage chemistry* in *mine* materials under the actual *minesite* conditions. Testing allows the evaluation of different *rock* types with varying *ABA* conditions. There is no standard design. See also *wall washing* stations.

**Filter Cake** - Solid residue remaining on a filter after filtering a fluid. See also *filtrate*.

**Filtrate** - Fluid that has passed through a filter. See also *filter cake*.

**Financial Security** - Funds provided through various financial instruments, which may be used by a regulatory authority to offset closure costs. See also *liability*.

**Fine Refuse** - *Tailings* like, waste product of coal *wash plant*. See also *coarse refuse*.

**Flocculant** - A substance that causes suspended *particles* to aggregate or clump together. The higher mass causes the aggregated clumps to settle. Flocculants are used to reduce high concentrations of fine *silt size* and *clay size* suspended *sediment*, particles whose slow settling rate makes them otherwise very difficult to remove. See also *suspension* and *sediment/settling pond*.

**Flotation** - A *milling* process using surface active chemicals to selectively modify some *mineral* surfaces causing them to become attached to air bubbles and float, while others do not and sink. This process allows the selective *concentration* and *recovery* of the valuable *minerals*. Pretreatments include *grinding* and addition of reagents.

**Flotation Circuit** - System of flotation cells and auxiliary equipment arranged to yield optimum *concentration* and *recovery*. The circuit may be divided into *rougher*, *scavenger* and *cleaner stages*.

**Flow Rate** - Amount (volume) of discharge per unit time (e.g. mL/s).

**Fluvial Materials** - *Non-lithified materials* transported and deposited by streams and rivers; synonymous with alluvial. Deposits generally consist of gravel and/or sand and/or silt (rarely, clay). Gravels are typically rounded and contain interstitial sand. Fluvial *sediments* are commonly moderately to well sorted and display *stratification*, although *massive*, non-sorted fluvial deposits do occur.

**Footwall** - The wall *rock* beneath an inclined vein, *ore deposit* or *fault* structure. See also *hanging wall*.

**Fracture** - **1.** A crack, joint, *fault* or other break in *rocks*. **2.** The breaking of a *mineral* other than along planes of cleavage.

**Framboidal** - A type of crystal structure characterized by clusters of tiny *pyrite* crystals (octahedrons), often in spheroidal aggregates resembling raspberry seeds.

**Geochemistry** - Study of the distribution and abundance of elements in *minerals, rocks, soils, water and the atmosphere.*

**Geology** - The study of the *earth*, its history and the changes that have occurred or are occurring and the *rocks and non-lithified materials* of which it is composed and their mode of formation and transformation.

**Geomorphology** - The study of landforms, their classification, description, nature, origin and development, their relationships to underlying *structures* and the history of geologic changes as recorded by these surface features.

**Geotechnical Engineering** - The application of scientific principles and engineering practices to materials of the *earth's crust* for the solution of engineering problems. It includes the study of *soil and rock mechanics*, and aspects of *geology, geophysics, hydrology* and related sciences.

**Glory Hole** - Surface depression created by an underground excavation which continues to or removes the crown pillar supporting the surface. Ore is removed through the underground workings. The connection to the surface may significantly increase air and water movement and alter drainage conditions, increasing metal leaching, reducing or preventing flooding and resulting in unstable geotechnical conditions.

**Gossan** - The rust coloured oxidized capping or staining of a *mineral deposit*, generally formed by the oxidation or *alteration* of iron *sulphides*.

**Grade** - Amount or weight of *metal or mineral* present in the host *rock*. Commonly expressed as %, ppm, ppb, g/t or oz/t.

**Grain** - Crystals or multi-crystal fragments within a *lithified matrix*. For example, sand grains in sandstone and quartz grains in sand sized particles.

**Grain Size** - The size range of fragments or crystals in consolidated materials. A description of the textural coarseness of a *rock*.

**Grind** - Reduce *particle size* into a fine powder through the impact or attrition. On a large scale typically achieved in a rotating cylinder. Includes rod and *ball mills* and *autogenous* and *semi-autogenous grinding*.

**Groundmass** - Finer grained material occurring between *phenocrysts* in porphyritic *igneous rock*. See also *matrix*.

**Groundwater** - The part of sub-surface water in the zone of saturation. Distinct from surface water. See also *phreatic*.

**Hanging Wall** - The wall or *rock* on the upper side of a vein, *ore deposit* or *fault* structure. See also *footwall*.



**Heap Leach** - An extraction process in which stockpiled *ore* is leached to remove target *metals*. *Leaching* solutions, generally weak *acids* or *alkaline* cyanide, are percolated through heaps of *ore*. *Leachate* is collected and *metals* contained in the *leachate* are extracted chemically or electrochemically. Typically, the *particle size* of the *ore* to be leached is reduced to increase surface exposure of metal containing minerals. Despite the reduced *particle size*, after *leaching* ceases, the heap typically has many properties in common with a *waste rock dump*. See also *bioleaching* and *cyanidation*.

**Heavy Metal** - A general term applied to *base metals* such as copper, lead and zinc that commonly occur in urban and industrial pollution. See also *precious metals*.

**Humidity Cell Test** - A *kinetic test* procedure used primarily to measure rates of *acid generation* and *neutralization* in *sulphide* bearing *rock*. Critical test conditions include detailed pre- and post-test sample characterization, running the test for sufficient duration, aerobic weathering conditions, the use of excess drainage to fully dissolve the soluble products of primary *mineral weathering* and conducting the necessary analyses on the drainage to model *mineral* solubility. The accuracy of the subsequent prediction will depend on the test procedures, the *sample* composition, the validity of the various assumptions and the manner in which the analytical data is interpreted. Details of the test protocols are critical to the interpretation and must be included with the results. The standard methodology is to place a *sample* of *rock* (about 1 kg) into an enclosed vertical plexiglass column and expose the *sulphides* within the *rock* to 3 days each of humid and dry air. On the seventh day, the test material is flushed and resultant *leachate sample* is collected and analyzed to determine its chemical composition. Results from the chemical analyses of the leachate are used to calculate primary mineral reaction rates. See also *humidified aeration*.

**Hydrated Lime** - Calcium hydroxide [Ca(OH)<sub>2</sub>]. Produced from calcium oxide (CaO) or *quick lime*. Used as a neutralizing agent. See also *lime*.

**Hydration** - The incorporation or presence of water within the chemical structure. See also *anhydrous*.

**Hydraulic Backfill** - Slurry *backfill* material, typically consisting of cycloned *tailings* sands, pumped and/or fed by gravity to the disposal site. Transportation as a slurry allows the solid fraction to be moved relatively cheaply to the *backfill* location. The post-deposition strength of the *backfill* is provided by inter-particle friction after the slurry drains. To enable the material to drain in a timely manner and create sufficient inter-particle friction, the solid fraction must be relatively free of fine sized *particles*. See also *paste backfill*.

**Hydraulic Conductivity** - A measure of the ability of a fluid to move through the interconnected void spaces in a sediment or rock. Flow through a porous medium in response to a unit potential gradient. Hydraulic conductivity depends upon both *permeability* and properties of the fluid such as viscosity and density. *Permeability* is a property of the *rock* or *non-lithified material*.

**Hydrogeology** - The study of *groundwater*. A branch of *hydrology*.

**Hydrology** - The study of all waters in and upon the earth, including groundwater, surface water and precipitation. When used in conjunction with the term *hydrogeology*, hydrology is more restrictively defined as the study of precipitation and surface waters.

**Hydrolysis** - A chemical reaction of a compound or ion with water in which water is split into  $H^+$  and  $OH^-$ .

**Hydrothermal** - Heated aqueous rich solutions and the processes (hydrothermal alteration) in which they are involved.

**Igneous Rock** - *Rock* formed by the solidification of molten or partially molten magma.

**Impoundment** - A structure or location used for confined storage. Impoundments are used to retain drainage, materials that must be flooded and materials that are physically unstable such as tailings and treatment sludge. Lakes or other natural depressions may serve as natural impoundments. Dams or *dykes* are used to construct artificial impoundments.

**Incongruent Weathering** - Different components or locations of a *particle, rock* or *mineral* wear down and change through climatic processes at different rates. Typically, some components remain relatively unaltered. An example is the selective removal of inter-layer potassium ions from muscovite (the silicon tetrahedron and aluminum octahedron layers remain relatively intact), producing illite if potassium is replaced by hydrogen or smectite if potassium is replaced by calcium.

**Infiltration** - The entry of water into a porous substance. See also *percolation* and *leaching*.

**Insufficiently Reactive Acid Potential** - The portion of the *acid potential* whose *weathering* rate is so slow that the rate of *acid generation* is negligible. Depends on the reaction rate of *minerals* contributing to the measured *acid potential* (AP) under the site specific environmental conditions (e.g. atmospheric  $O_2$  content, *drainage chemistry* and leaching rate). See also *unavailable* and *effective acid potential*.

**Insufficiently Reactive Neutralization Potential** - The portion of a laboratory *neutralization potential* measurement that is unable to neutralize *acidity* and maintain a *near-neutral drainage pH* because the *weathering* rate is insignificant relative to the rate of *acid* inputs. Insufficiently reactive and *unavailable NP* can be predicted from the NP measured in materials that are just about to and have just gone acid. See also *unavailable* and *effective neutralization potential*.

**Intrusion** - A body of *igneous rock* that invades older, pre-existing *rock*.

**Kinetic Effects** - The results of dynamic physical or chemical processes. Dynamic processes include the rates of chemical reactions and the physical changes which determine

properties like *particle size*, surface area, *metal loadings* and *drainage chemistry*. To a large degree, the dynamic ML/ARD processes result from the *weathering* processes that occur when *bedrock minerals* are exposed to oxygen and water. Kinetic chemical effects are described through reaction rates in which concentrations will continue to increase or decrease through time until the system reaches *chemical equilibrium*, the other major chemical condition affecting *drainage chemistry*.

**Kinetic Test** - A procedure used to measure the magnitude and/or effects of dynamic processes, including rates of reaction, material *alteration* and *drainage chemistry* and loadings that result from *weathering*. Unlike *static tests*, kinetic tests measure the performance of a *sample* over a prolonged period of time. Material composition and/or environmental conditions are often simplified or controlled to permit measurement of the physical, chemical, or biological characteristics, processes or relationships which are of interest. Kinetic tests have many different forms and locations, including *lysimeters*, field test pads, *leach columns* and *humidity cells*. In ML/ARD studies, the most common form of kinetic tests are laboratory procedures designed to determine the quality of water and rates of reaction resulting from the interaction of water and the mine material. Tests can be divided into two categories, those designed to simulate *drainage chemistry* (e.g. *leach columns*) and those designed to measure primary reaction rates (e.g. *humidity cell test*).

**Labile** - *Rocks* and *minerals* that easily decompose.

**Leach** - The extraction of soluble constituents by percolating a solvent through it. A natural or induced process. See *metal leaching*, *kinetic test* and *dissolution*.

**Leachability** - A quantitative or qualitative term used to describe the degree of reaction with a *leaching* agent. Leachability can be reported for the whole or a portion of a *sample* or mine component and is determined by the solubility of the reactant and the type, relative volume and *percolation* rate of solvent.

**Leachate** - Solution obtained from a *leaching* process.

**Leach Column** - A *kinetic test* designed to simulate the *leaching* and secondary *mineral* precipitation and dissolution that determine *drainage chemistry*. In a leach column, the test material is placed in some form of tube and subjected to natural *leaching* in a field test or an artificial *leaching* regime in a laboratory study. Columns are most commonly set up in the laboratory. Laboratory studies attempt to simulate the important aspects of field *weathering* conditions. Secondary *mineral* precipitation and dissolution in the areas of *leaching* may be detected through changes in *leachate* composition. Columns may be constructed of plexiglass to allow the observation of changes in colour or other physical properties. Post-test analysis of the test materials may be used to evaluate changes in the solid phase, spatial variability and/or the *mineral* factors controlling *drainage chemistry*. The accuracy of the subsequent prediction will depend on the test procedures, the *sample* composition, the validity of the various assumptions and the manner in which the analytical data is interpreted. Details of the test protocols are critical to the interpretation and must be included with the results.

**Liability** - All outstanding work requirements or equivalent monetary requirements. See also *financial security*.

**Lime** - Calcium oxide (CaO). Also referred to as *quick lime*. Produced by heating *limestone* (CaCO<sub>3</sub>) above 550°C in a kiln. Used to make calcium hydroxide [Ca(OH)<sub>2</sub>] or *hydrated lime*, a cheap neutralizing agent and to produce a slag from the impurities in *metal ores*.

**Limestone** - A sedimentary *rock* consisting largely of calcite (CaCO<sub>3</sub>). Dolomite, chert and clay are common impurities.

**Limestone Drain** - *Limestone* placed in a *drainage* channel or trench constructed to collect and neutralize acidic drainage. See also *anoxic limestone drain*.

**Lithology** - **1.** The description of *rocks*, especially in hand specimens and *outcrops*, generally determined megascopically or with the aid of a low power magnifier. **2.** A *rock* type defined by a distinct set of physical and mineralogical characteristics.

**Littoral** - Belonging to, inhabiting or taking place on or near the shore.

**Loading** - Aqueous concentration multiplied by flow, providing a mass per unit of time flowing through or from a *mine component*.

**Low Grade Ore** - *Ore* that is relatively deficient in the target *metals/minerals*. A term usually used for materials that could be *ore* under favourable economic conditions. See also *waste rock*.

**Low Grade Ore Stockpile** - A *mined rock pile* containing *low grade ore* segregated to permit milling at some later date when economic conditions become more favourable. See also *ore stockpile*.

**Major Element** - Those elements that commonly occur in relatively large concentrations. Elements that commonly occur in geologic materials at concentrations of more than 1 wt%. Usually includes aluminum, calcium, iron, magnesium, potassium, silica and sodium.

**Marine Materials** - *Sediments* deposited in salt or brackish water bodies by settling from *suspension* and submarine gravity flows or *sediments* that have accumulated in the *littoral* zone through shoreline processes such as wave action and longshore drift. Marine *sediments* deposited offshore generally consist of clay, silt and sand that is well to moderately well sorted and well stratified to *massive*. *Littoral* marine *sediments* consist of well sorted and well rounded gravels and *sand*. Both *littoral* and offshore marine *sediments* may contain shells and the remains of other marine organisms.

**Mass Wasting** - A general term used for processes by which large masses of *non-lithified material* are moved by gravity, either slowly or quickly, from one place to another.

**Massive** - A homogeneous *structure*, without *stratification*, flow banding, foliation or bedding.

**Material Handling** - A term used to describe the combined processes of *waste rock* and *ore* excavation, transportation and deposition, including any temporary stockpiling, rehandling and secondary treatment.

**Matrix** - The *groundmass* of an *igneous rock* or the finer grained material enclosing the larger grains in *non-lithified materials*, a *sediment* or sedimentary *rock*.

**Metal** - A class of chemical elements generally characterized by ductility, malleability, luster and conductivity of heat and electricity including alkali, alkali earth, *base*, *heavy* and *precious metals*. See also *metalloid*.

**Metal Leaching** - The extraction of soluble *metals* by percolating solvents. *Leaching* may be natural or induced. Primary *mineral weathering* commonly accelerates *metal dissolution* and removal in *minesite drainage*.

**Metalloid** - A class of elements chemically intermediate in properties between *metals* and non-*metals* including boron, silicon, germanium, arsenic and tellurium. Electrical semi-conductors and their oxides are *amphoteric*. Also called semi-metals. See also *sulphosalt*.

**Metallurgy** - Study of metals and their properties and structure, the *concentration* and refining of *ore*, the production of alloys and the shaping and treatment of *metals* by heat and rolling.

**Mill** - 1. *Milling plant*. 2. A piece of grinding equipment using a revolving drum. Examples include rod and *ball mills*. See also *autogenous* and *semi-autogenous grinding*.

**Milling Plant** - A plant in which *ore* is treated for the recovery and/or *concentration* of valuable *minerals* prior to shipment to a smelter or refinery. Milling processes include *crushing*, *grinding*, *screening*, *concentration* and dewatering. At a coal mine, the mill is referred to as a wash plant, tippie or cleaner. Some processes are divided into *rougher*, *scavenger* and *cleaner stages* of recovery and/or *concentration*.

**Mine** - A mine includes: a) a place where mechanical disturbance of the ground or any excavation is made to explore for or produce coal, metallic *ore*, *industrial minerals* or placer minerals; b) all cleared areas, machinery and equipment for use in servicing a mine or for use in connection with a mine and buildings other than bunk-houses, cook houses and related residential facilities, c) excavation and any associated activities including exploratory drilling, processing, *concentrating*, waste disposal and site *reclamation*, and d) closed and abandoned *minesites*. See also *mine component*, *minesite*, *open pit* and *underground workings*.

**Mine Component** - A physically distinct portion of a *mine* such as a *tailings impoundment*, *waste rock dump*, *ore stockpile*, *open pit*, *underground workings*, a building foundation or a road.

**Mine Site Drainage** - Water that runs off or flows through a *minesite*, including surface and sub-surface (*groundwater*) flow. See also *acid mine drainage*, *near-neutral pH*, *alkaline drainage* and *drainage chemistry*.

**Mine Site Environment** - In the context of *metal leaching* and *acid rock drainage*, the additive and interactive physical, chemical, biological and *anthropogenic* conditions at a *minesite*.

**Mined Rock Piles** - A general term for the accumulation of excavated *rock* at a *mine*, including *waste rock dumps*, *ore* and *low grade ore stockpiles*. Used for roads, *heap leach* piles and building foundations.

**Mineral** - A naturally occurring inorganic element or compound having an orderly internal structure and characteristic chemical composition, crystal form and physical properties.

**Mineral Deposit** - A naturally occurring mass of economically valuable metallic or non-metallic *minerals* that are not necessarily economically recoverable. See also *ore*.

**Mineralogy** - Study of *minerals* including their formation, occurrence, properties, composition and classification.

**Minesite** - The location of a mining project, including the area or areas of excavation and adjoining areas or nearby facilities for *materials handling*, processing and waste disposal. See also *mine* and *mine component*.

**Minor Element** - Those elements that commonly occur in geologic materials at concentrations of 0.1 to 1 wt%. Usually includes manganese, phosphorous and titanium.

**Mitigation** - An activity aimed at avoiding, controlling or reducing the severity of adverse physical, chemical, biological and/or socioeconomic impacts of a project activity.

**Model** - A formalized expression of a theory, event, object, process or system used for prediction or control; an experimental design based on a causal situation that generates observed data. A model can be viewed as a selective approximation which by the elimination of incidental detail, allows some fundamental, relevant or interesting aspect of the real world to appear in a generalized form.

**Muck** - *Ore* or *waste rock* that has been broken apart, usually by blasting.

**Near-Neutral** - See *near-neutral pH* and *near-neutral drainage*.

**Near-Neutral Drainage** - A general term applied to any *drainage* with a *near-neutral pH* without large excesses of *acidity* or *alkalinity*.

**Near-Neutral pH** - A *near-neutral pH* is defined as a value between 6.0 and 8.0. See also *acidic*, *basic* and *alkaline pH*.

**Net Acidic** - Material that if leached will presently produce *acidic drainage*. *Acidic drainage* results from a higher *acidity* addition than *neutralization*. An *acidic rinse pH* is evidence that a *sample* is presently net acidic. Although a *mine* component or *sample* as a whole is net acidic, some portion of the *surface* of *particles* or fracture surfaces (micro-sites) and the interior of *particles* may produce *alkaline* or *near-neutral* pH drainage. NP measured in a *net acidic mine component* or *sample* is either physically *unavailable* (e.g. occluded within particles and not exposed to air or drainage) or *insufficiently reactive* to produce net *near-neutral* pH or *alkaline drainage*. See also *net drainage pH*, *acid* and *acidity*.

**Net Alkaline** - Material that if leached will presently produce *alkaline pH drainage*. *Near-neutral* pH drainage results from a higher rate of *acid neutralization* than acidity addition. An *alkaline rinse pH* is evidence that the *sample* is presently *net neutral*. Although a *mine* component or *sample* is predominantly *alkaline*, some parts, *grains* or fracture surfaces may produce *alkaline* or *acidic drainage*. AP measured in a presently neutralized *mine* component or *sample* is (1) insufficiently large, or (2) insufficiently physically available (e.g. partially occluded within *particles* and not exposed to air or drainage) or (3) *insufficiently reactive* to produce *acidic drainage*.

**Net Drainage pH** - The pH of the overall *drainage* for a specified material, at present or at some time in the future and some assumed future geochemical conditions. The procedures used to measure or predict the net drainage pH should be clearly identified. All geologic constituents are assumed to be exposed to oxidizing *weathering* conditions and there is sufficient time for complete oxidation of the sulphide *minerals*, unless otherwise specified. The net drainage pH will depend on the cumulative rates of *acid* and base addition from all contributing internal and external sources. External sources may include: dust, precipitation and *groundwater*. Internal sources include: *mineral weathering* and the reactions of dissolved and amorphous species. Differences in the cumulative rates of *acid* and *base* addition and *acid neutralization* and the *drainage pH* may occur at the micro-scale level (e.g. pore water), in different *rock* types and locations in *mine* component (e.g. surface, sub-surface and laterally), in areas with different *weathering* conditions (e.g. aerobic or flooded locations) and with different times of exposure (e.g. present or sometime in the future). If possible, significant differences in the rates of *acid* and *base* addition and *acid neutralization* and the *drainage pH* at different scales, locations, times and under different *weathering* conditions should be indicated (e.g. *net acidic drainage* at the surface of *tailings* in the future).

**Net Neutral** - Material that if leached will presently produce *near-neutral pH drainage*. *Near-neutral* pH drainage results from a higher rate of *acid neutralization* than acidity addition. A *near-neutral rinse pH* is evidence that the *sample* is presently net neutral. Although a *mine* component or *sample* is predominantly *near-neutral*, some parts, *grains* or *fracture* surfaces may produce *acidic drainage*. AP measured in a presently neutralized *mine* component or *sample* is (1) insufficiently large, or (2) insufficiently physically available (e.g. partially occluded within *particles* and not exposed to air or drainage) or (3) *insufficiently reactive* to produce *acidic* or *alkaline drainage*.

**Net Neutralization Potential (NNP)** - *Effective neutralization potential minus acid potential* (NP minus AP). Calculated as part of Acid Base Accounting. Expressed in units of kilograms of CaCO<sub>3</sub> equivalent per metric *tonne* of *sample* (kg CaCO<sub>3</sub>/t), t CaCO<sub>3</sub> equivalent/1000 t, parts per thousand (ppt) CaCO<sub>3</sub> equivalent [all are equal], mg CaCO<sub>3</sub>/g or g CaCO<sub>3</sub>/kg. The methods used to determine effective NP and AP should be clearly identified.

**Neutralization** - Raising the *pH* of *acidic* materials or the lowering the *pH* of *alkaline* materials to *near-neutral pH* values through a reaction in which the hydrogen ion of an acid and the hydroxyl ion of a *base* combine to form water, the other product being a salt. See also *buffering capacity*.

**Neutralization Potential (NP)** - See *acid neutralization potential*.

**Neutralization Potential Ratio (NPR)** - *Effective neutralization potential divided by acid potential* (NP divided by AP). Calculated as part of Acid Base Accounting. The methods used to determine NP and AP should be clearly identified.

**Neutralize** - Carrying out *neutralization*.

**Non-Lithified Surficial Material** - Inorganic and organic matrices consisting of *particles* produced by *weathering*, *sediment* deposition, biological accumulation, human or volcanic activity and occurring on the planet earth's surface. Natural *non-lithified materials* include *particles* created from the in-situ *weathering* of *rock*, transported and deposited by water, wind, ice or gravity, chemically precipitated from solution, secreted by organisms or any combination of these agents. Anthropogenic *non-lithified materials* include *waste rock* and *tailings*. Terms with similar meanings include “Quaternary *sediments*” “*surficial materials*” and “*unconsolidated materials*” (*geology*), “*soil*” and “*earth*” (*engineering*), and “*overburden*” (*soil scientist*). Non-lithified materials are classified according to their mode of formation, in addition to their physical properties (e.g. *waste rock* and *tailings*). Differences in the processes of formation, such as *erosion*, transportation, deposition, *mass wasting* and *weathering*, produce materials with differing physical characteristics.

**Not-Potentially Net Acidic or Not-Potentially ARD Generating (Non-PAG)** - *Net-neutral* or *alkaline* material predicted to continue produce *near-neutral* or *alkaline pH drainage* in the future. Unless otherwise specified, it is assumed that all geologic constituents are exposed to oxidizing *weathering* conditions and there is sufficient time for complete oxidation of the *sulphide* minerals. The procedures used to predict the future *net drainage pH* should be clearly identified. Materials will continue to be *net neutral* or *alkaline* if the rate of *acid neutralization* keeps up with the *acidity* additions and sources of acidity are exhausted prior the sources of *acid neutralization*. *Acidity* and *acid neutralization* may come from external sources (e.g. precipitation and groundwater), in addition to in-situ *weathering reactions*. Although a mine component or sample is predominantly *alkaline* or *near-neutral*, some parts, *grains* or *fracture* surfaces may produce *acidic drainage*.



**Occlude** - To obstruct, cover or otherwise block an opening.

**Open Pit or Open Cut** - A surface depression created by the excavation of near surface metallic *ore*, *industrial minerals*, placer minerals or coal. In *open pit* mining, *overburden* covering the deposit is removed, exposed *ore* is blasted and moved to a *mill*, and *waste rock* is placed in one or more *waste rock dumps*. Referred to as an open cast *mine* or quarry in some places. An alternative to *underground workings*.

**Ore Deposit or Body** - A continuous well defined mass of material containing sufficient quantities of the valuable material to make extraction economical.

**Ore Reserves** - The calculated tonnage and grade of *ore* which can be extracted profitably. *Ore* reserves can be classified according to the level of confidence that can be placed in the data.

**Ore** - *Rock*, *sediments*, or *non-lithified materials* that contain economically recoverable levels of coal, *metals* or *minerals*. See *cut-off grade*, *low grade ore stockpile*, *tailings* and *waste rock*.

**Organic Sulphur** - Sulphur bound to organic compounds. Potentially a significant portion of *total sulphur* in coal deposits, black shales and materials that now or in the past supported plant growth.

**Outcrop** - A surface exposure of *bedrock*, not covered with *non-lithified material* or water.

**Overburden** - At *metal mines*, the term *overburden* refers to naturally *non-lithified materials*. At coal *mines*, the term *overburden* is also used for the *bedrock* on top of the coal seams.

**Oxidant (Oxidizing Agent)** - A compound capable of receiving electrons and being itself reduced while bringing about the *oxidation* of other compounds.

**Oxidation** - **1.** The removal of one or more electrons from an ion or atom. **2.** A process of decomposition in which electrons that hold matter together are transferred to another compound called an *oxidant*. **3.** Process of combining with oxygen.

**Parent Material** - The material from which it is derived.

**Particle** - Separate fragments in an unconsolidated *matrix*. For example, the particle of various sizes in *waste rock* and *till*. To avoid confusion, it is recommended that use of the term *grain* be limited to crystals or multi-crystal fragments within a consolidated *matrix*. For example, sand grains in sandstone.

**Particle Size** - The dimension of *particles*. Commonly measured by sieving, settling velocities and image analysis. Particle sizes include the various types of coarse fragments (> 2 mm), such as boulders, stones and gravel, and the different *soil-sizes* (< 2 mm), *sand* (2 mm - 62.5 µm), *silt* (2 µm - 62.5 µm) and *clay* (< 2 µm).

**Paste** - A mixture of solids and water that when left to stand idle adhere together. See also *paste backfill*.

**Paste Backfill** - Slurry *backfill* material, pumped and/or fed by gravity to the disposal site. Transportation as a *slurry* allows the solid fraction to be moved relatively cheaply to the *backfill* location. Paste backfill is created with whole *tailings* as opposed to the cycloned sands used in *hydraulic backfill*. In cemented paste backfill, cementing agents like hydrated *lime* and fly ash may be used to increase strength and accelerate curing. Experience has shown that materials where at least 15% of the *particles* are less than 20 mm are likely to exhibit *paste* properties.

**Paste pH Analysis** - The *pH* of the solution created when a pulverized *sample* is mixed with distilled/*deionized water*. Carried out as part of Acid Base Accounting. Important variables include the solid:water ratio and the relative magnitude of weathered surfaces and the unweathered interior of *particles*. See also *rinse pH*.

**pe** - The negative logarithm to the base 10 of the hypothetical activity of the free electrons in solution. Calculated from the *Eh*.

**Percolation** - Downward flow of water within an unsaturated porous medium.

**Permeability** - The capacity of a *rock* or *non-lithified material* to transmit fluid. See also *hydraulic conductivity*.

**Petrography** - The branch of *geology* dealing with the description and systematic classification of *rocks*, especially by means of microscopic examination of thin sections. More limited in scope than *petrology*.

**Petrology** - The branch of *geology* dealing with the origin, occurrence, history and structure of *rocks* as determined from *petrography* and *geochemistry*. See also *lithology*.

**pH** - The negative logarithm to the base 10 of the hydrogen ion activity  $[H^+]$  in solution.

**Phenocryst** - A relatively large crystal within the finer grained *matrix* of an *igneous rock*. See also *porphyry* and *groundmass*.

**Pillar** - A block of solid *ore* or rock left in place to structurally support the *shaft*, walls or roof in a *mine*.

**Pit** - See *open pit*.

**Plan View** - A horizontal section. Used to illustrate features at the surface or a specific depth.

**Plant Site** - The location of the *process plant*.

**Pollutant** - See *contaminant*.

**Pore Water** - Water that fills the voids between the grains of sediment.

**Porphyry** - An *igneous rock* of any composition that contains conspicuous *phenocrysts* in a finer grained *matrix*.

**Porphyry Deposit** - A large tonnage, low grade *mineral deposit* with relatively uniform grade, which may be mined by *open pit* methods if it occurs in close proximity to surface.

**Portal** - Surface entrance to an *adit, level, incline* or *decline*.

**Potentially Net Acidic or Potentially ARD Generating (PAG)** - *Net-neutral* or *alkaline* material predicted to become *net acidic* in the future. Unless otherwise specified, it is assumed that all geologic constituents are exposed to oxidizing *weathering* conditions and there is sufficient time for complete *oxidation* of the *sulphide minerals*. The procedures used to predict the future *net drainage pH* should be clearly identified. Materials that are presently *net neutral* or *alkaline* will become *net acidic* in the future if the rate of *acid neutralization* is unable to keep up with the addition of *acidity*, either due to a decrease in the rate of acid neutralization or an increase in the rate of addition of *acidity*. The rate of *acid neutralization* will be reduced and materials will become *acidic* in the future if the sources of *acid neutralization* are exhausted prior to internal acid generation and external sources of acidity. Changes in the rates of *acid generation* and *neutralization* may result from changes in surface exposure of the reactants and changes in *weathering* conditions (e.g. increased physical exposure or reduced height of the water table). *Mitigation* measures, such as flooding that reduce the rate of *acid generation*, may prevent potentially net acidic materials from becoming *acidic* in the future. Materials whose future net drainage is uncertain may be classified as *potentially acidic in the future*. See also *net drainage pH, acid* and *acidity*.

**Precious Metal** - A general term applied to relatively more expensive metals, such as gold, silver and platinum, which based on cost can be distinguished from *base* and the alkali and alkali earth metals. Sometimes called the noble metals. Costs vary according to supply and demand. In the past, silver has been less expensive than the so called non-precious (*base*) metal molybdenum.

**Primary Mineral** - A *mineral* that came into existence at the time the *rock* was formed and that retains its original composition and form. Includes *minerals* formed by *igneous, hydrothermal* or *pneumatolytic* processes. See also *secondary mineral*.

**Process Plant** - See *milling plant*.

**Process Water** - Water used in the *milling* process.

**Proponent** - An individual, organization, company or institution operating or planning to initiate a project.

**Pulp** - **1.** Pulverize or grind to powder. The term can refer to both the action and the product. **2.** In a *mill*, the term refers to any *slurry* of solid *particles* and water.

**Pyrolysis** - Chemical change brought about by heat.

**Quality Assurance/Quality Control (QA/QC)** - Methods used to assure the quality of information in the planning/testing stages (QA) and to check the quality of the resulting information from the execution stage (QC).

**Raise** - A vertical or inclined *underground working* excavated upwards. See also *adit*.

**Receiving Environment Objectives** - Target conditions protective of water uses. The receiving environment objectives, which can be generic or site specific, provide a quantifiable means of determining whether environmental protection measures are effective (goal posts). Due to the relative ease of measurement and the sensitivity of the environment, the most common receiving environment objectives are *metal* concentrations in *drainage*. Other important aquatic parameters include physical and chemical attributes of water and *sediment* and *species* diversity, abundance and toxicity. See *water quality criteria* and *water quality objectives*.

**Reclamation** - An activity aimed at rehabilitating a disturbed site to a higher level of productivity.

**Recovery** - The percentage of valuable *metal* in the *ore* that is recovered from the host *rock* by metallurgical treatment.

**Redox Conditions** - A measure of the theoretical electron activity of an *environment*. A high redox potential indicates *aerobic* conditions. A low redox potential indicates oxygen poor or reducing conditions. See *Eh*.

**Relative Density** - Ratio of the density of a solid or liquid to the density of water at a specified temperature. See also *specific gravity*.

**Residual Effects** - Effects that persist after processes have finished or measures have been applied.

**Retained Weathering Products** - The portion of a material altered by *weathering* not removed by *leaching*. Affected by physical factors such as the quantity of *drainage* and geochemical processes like the precipitation and *dissolution* of *secondary minerals*. See also *incongruent weathering*.

**Rinse pH** - The *pH* of the solution created when a non-pulverized *sample* is mixed with distilled/*deionized water*. Pulverizing is avoided to ensure only the weathered surfaces contribute to the measured pH. This procedure should be substituted for *paste pH* in Acid Base Accounting for *weathered samples*. Testing is usually carried out on fine sized materials or the finer fraction (for example, < 2 mm) of coarse materials. Rinse pH can provide an estimate of *drainage pH*. Important variables include the solid:water ratio.

**Risk** - The probability and consequences of failure.

**Rock** - Naturally formed, solid mass of one or more *mineral*, *amorphous* inorganic matter or organic matter. See also *lithify*.

**Rougher Stage** - A term applied to the initial phase of *concentration* and *recovery*. This term is most commonly used in the processing of metallic *ores*. The feed may include recycled scavenger *concentrate* or cleaner tailings in addition to the initial *mill* feed. The rougher *concentrate* may be upgraded by further processing (*cleaner stages*). Typically, most of the *tailings* mass is produced in the rougher stage. *Rougher tailings* may also be treated further (cleaned) to reduce the ARD potential of the main *tailings* mass. The ARD potential is typically reduced by removing *sulphides*. See also *flotation circuit* and *scavenger* and *cleaner stages*.

**Rougher Tailings** - *Tailings* generated in *mill processing* in the initial stage(s) of *ore* concentration. The distinction of rougher tailings suggests that further, more refined processing is carried out resulting in other *tailings* and/or a higher *grade concentrate* being produced. Typically, most of the *tailings* mass occurs in this fraction. A *sulphide rich cleaner tailings* may be produced where *sulphide flotation* is used to reduce the ARD potential of the rougher *tailings*.

**Runoff** - That part of precipitation and snowmelt that does not infiltrate but moves as overland flow. See also *minesite drainage*, *evapotranspiration* and *infiltration*.

**Sample** - A representative fraction, usually relatively small, collected for analysis or description. See also *composite sample*.

**Sand Sized** - *Particles* 62.5  $\mu\text{m}$  to 2 mm in diameter.

**Saprolite** - *Bedrock* decomposed in-situ by chemical *weathering*.

**Scatterplot** - A graphical plot showing the distribution of data points between two axes.

**Scavenger Stage** - A term commonly used in the processing of metallic *ores* for the last phase of *recovery* of the valuable material from tailings. Scavenging may occur at the latter part of the rougher or cleaner circuits or separately with a separate feed box. The feed in a scavenger circuit is *tailings* from the previous circuit. Scavenger concentrate may be added to the *concentrate*, recycled to the previous circuit or treated separately, with or without regrinding. See also *flotation circuit* and *scavenger* and *cleaner stages*.

**Scope** - The definition of what has been or needs to be done in a study program.

**Secondary Mineral** - A *mineral* formed by surface processes, usually at the expense of an earlier formed *primary mineral*. The result of *alteration*, *dissolution* or precipitation. See also *primary mineral*.

**Security** - See *financial security*.

**Sediment** - Solid fragmental materials, both inorganic and organic, that have been deposited after being transported by air, water, or ice, chemically precipitated from solution or secreted by organisms.

**Semi-Autogenous Grinding (SAG)** - A method of *grinding rock (ore)* into a fine powder using a grinding media which includes both the larger chunks of the *ore* itself and steel balls. See also *autogenous grinding* and *ball mill*.

**Shaft** - Vertical or inclined *underground working* excavated downwards. Commonly used for hoist based transportation of workers and/or *ore* and *waste rock*. See also *incline* and *raise*.

**Silicates** - Compounds containing silica and oxygen as the main constituents. See also *aluminosilicates*.

**Silt Sized** - *Particles* 2 µm to 62.5 µm in diameter.

**Skarn** - *Metasomatic* rocks formed by the introduction of fluids containing large amounts of silicon, aluminum, iron and magnesium into nearly pure *limestone* or dolomite *country rocks*. Composed mostly of lime bearing *silicates*.

**Slaking** - The crumbling and disintegration of materials upon exposure to air and moisture. See also *weathering*.

**Slurry** - A thick suspension of solids in a liquid.

**Snow Pack** - Residual accumulated snow and ice. In many parts of Canada, the snow pack contributes a major part of the site *drainage (freshet)*.

**Soil** - The upper portion of *non-lithified materials* that has been altered over a period of time, as a result of plant growth, climate (including moisture and temperature effects), *drainage*, macro- and microorganism activity or topographical position, producing a product – *soil* – that differs from the *parent material* (regolith) in many physical, chemical, biological processes and morphological properties. Soil can develop from both natural or *anthropogenic parent materials*. Soil either serves or has the potential to serve as a medium for the growth of terrestrial or *wetland* plants.

**Soil Science** - The study of the non-lithified portion of the earth, its *alteration* as a result of time, plant growth, climate (including moisture and temperature effects), *drainage*, macro- and microorganism activity or topographical position, the resulting physical, chemical, biological and morphological properties and processes and their effect on soil use and other resources.

**Soil Separate** - One of the individual groups of inorganic *soil sized particles*: *sand*, *silt* and *clay*.

**Soil Texture** - The relative proportions of *sand sized* (62.5 µm-2 mm), *silt sized* (2 µm-62.5 µm) and *clay-sized* (< 2 µm) *particles* in the *soil sized* (< 2 mm) fraction.

**Soil Sized** - *Particles* < 2 mm in diameter.

**Solubility** - The quantity of solute that dissolves in a given volume and type of solvent, at a given temperature and pressure, to form a saturated solution. The degree to which compounds are soluble depends on their ability and that of the other dissolved *species*, to form ions and aqueous complexes in a particular *drainage chemistry*.

**Sorting** - The variation of *particle* sizes within a sedimentary unit. Statistically, measurements include the spread of the *particle* size distribution on either side of the mean. Materials consisting of *particles* of nearly uniform size are said to be well sorted. Non-sorted materials like *till* tend to have a wide variation of *particle* sizes.

**Speciation** - The chemical form in which an element is present or the process whereby various states or forms of an element become differentiated into ions.

**Species** - A chemical entity such as an ion, atom or molecule.

**Specific Gravity** - See *relative density*.

**Spoils** - See *waste rock*.

**Static Test** - A procedure for characterizing the physical, chemical or biological status of a *sample* at one point in time. Includes measurements of the *mineral* and chemical composition and the analyses required in *Acid Base Accounting*.

**Stockpile** - A pile of excavated *rock* or naturally *non-lithified material* placed in anticipation of later use or re-handling. See also *low grade ore* and *ore*.

**Stratification** - A horizontal or inclined *structure* in a sedimentary unit that results from its mode of deposition; includes beds, laminae, abrupt and gradational textural changes and orientation of *particles*.

**Strip Mine** - A general term for an *open pit mine*, usually used for coal mines. The term strip may refer to the removal of the surface or that mining occurs in long, linear strips. In the later case, coal may be mined by removing *overburden*, excavating the coal seam and filling the excavation with *overburden* removed from the adjacent strip.

**Stripping Ratio** - The ratio of non-*ore* or non-coal material (*lithified* or *non-lithified*) that must be excavated to extract a given amount of *ore* or coal. A measure of the amount of material that must be excavated in order to remove the coal or *ore grade* material. See also *ultimate pit*.

**Structure - 1.** The general disposition, attitude, arrangement or relative positions of *rock* masses in a region, including bedding, *stratification*, laminations, *faults*, *fractures* and folds. **2.** The physical arrangement of *particles* within natural or *anthropogenic non-lithified materials*, including bedding, *stratification*, aggregation and *bulk density*.

**Sub-aerial** - Occurring on the land surface. See also *subaqueous* and *aerial*.

**Subaqueous** - Occurring under water. See also *sub-aerial*.

**Sulphate** - A *mineral*, compound or ion containing the  $\text{SO}_4^{2-}$  functional group in which sulphur is in the +6 oxidation state.

**Sulphide** - A *mineral*, compound or ion containing the  $\text{S}_2^{2-}$  or  $\text{S}^{2-}$  functional group in which sulphur is in the -1 or -2 oxidation state. Sulphide minerals also contain *metals* (e.g., pyrite,  $\text{FeS}_2$ , galena,  $\text{PbS}$  or or chalcopyrite,  $\text{CuFeS}_2$ ) or *metalloids* (e.g. arsenopyrite,  $\text{FeAsS}$ ).

**Sulphide Oxidation** - Exothermic *oxidation* of chemically reduced *sulphide* ( $\text{S}_2^{2-}$  or  $\text{S}^{2-}$ ) to a partially or fully oxidized form, such as *sulphate* ( $\text{SO}_4^{2-}$ ). One indication of *sulphide oxidation* is elevated *sulphate* concentrations in *drainage*.

**Sulphide-Sulphur** - Sulphur occurring in the *sulphide* oxidation state. The analysis for sulphide-sulphur is one in a series of sulphur analyses that are a part of Acid Base Accounting. Expressed as % S.

**Sulphidic geologic materials** - Geologic materials containing sulphide minerals and/or the sulphur products of weathering, processing or hydrothermal alteration. Drainage chemistry depends on the reactivity of the geologic materials as a whole, not just the sulphur-containing *minerals*.

**Sulphosalt** - A *sulphide mineral* in which a *metal* and a *metalloid* are present (e.g. arsenopyrite,  $\text{FeAsS}$ ).

**Sump** - An excavation or natural depression where water accumulates allowing it to be pumped to an alternative location.

**Surficial Materials** - See *non-lithified material*.

**Suspension** - A mixture of solid *particles* and liquid in which the fluid dynamic forces (e.g. upward currents in turbulent flow) exceed gravitational forces and the *particles* are unable to settle. See also *flocculent* and *settling pond*.

**Tailings** - The ground *rock* waste product from a *mill* or *process plant*, the materials remaining after the economically valuable elements are removed from the *ore*. To remove the valuable elements, blasted *rock* typically goes through several steps of crushing and extraction or washing. The *tailings* usually leave the *mill* as a *slurry* of *sand sized* and/or *silt sized particles* in water. *Tailings* are commonly stored in a surface *impoundment* but can also be placed sub-aqueously in natural water bodies or backfilled into *underground workings*.

**Tailings Impoundment or Tailings Pond** - A *tailings* disposal area in which *tailings* are confined by the natural topography or by one or more engineered *dykes* or dams. See also *impoundment*.



**Talus (Scree) Slope** - An accumulation of sharp angular *rock* fragments at the base of a cliff. Produced by frost action and other processes acting on the exposed *bedrock* slope. See also *colluvium*.

***Thiobacillus ferrooxidans*** - A naturally occurring bacteria that can derive energy from the oxidation of *sulphide* to *sulphate* and ferrous to ferric iron. Thought to accelerate the oxidation of *sulphides*. Genus recently renamed to *Acidithiobacillus*.

**Till** - *Non-lithified material* deposited directly by glacial ice without modification by any other agent of transportation. *Till* can be transported beneath, beside, on, within and in front of a glacier. The mineralogical, textural, structural and topographic characteristics of *till* deposits are highly variable and depend upon the original source and the mode of deposition. In general, *till* consists of well compacted to non-compacted material that is non-stratified and contains a heterogeneous mixture of *coarse fragments* in a *matrix* of *sand, silt* and *clay*.

**Titration** - Determining the amount of one substance by adding standardized increments of another. Often performed with an indicator to identify the endpoint.

**Toe** - The bottom of a slope.

**Tonne** - Metric weight measurement equal to 1,000 kg (2,204 lbs).

**Total Sulphate-Sulphur** - All sulphur occurring as *sulphate*. One in a series of sulphur analyses that are a part of Acid Base Accounting. Expressed as % S. See *acid-leachable sulphate-sulphur*.

**Total Sulphur** - All the sulphur in a *sample*. One in a series of analyses that are a part of Acid Base Accounting. Expressed as % S. See also *sulphide-sulphur, acid leachable sulphate-sulphur, total sulphate-sulphur, organic-sulphur, del % S*.

**Trace Elements** - Those elements that commonly occur in relatively small concentrations, such as boron, cadmium, and cobalt. Elements that commonly occur in geologic materials at concentrations of less than 0.1 wt% or in water at concentrations less than 1 mg/L. Includes all *precious metals* and *base metals*, with the exception of aluminum and iron. See also *major elements* and *minor elements*.

**Transpiration** - Process by which plants release water vapour to the atmosphere. See also *evapotranspiration*.

**Treatment Sludge** - Precipitated solid matter produced by a treatment process. See also *active chemical treatment*.

**Trench** - A narrow surface excavation dug. Blasting may be required in *bedrock*.

**Ultimate Pit** - The maximum expected extent of an *open pit*. A design that maximizes the amount of *ore* recovered while minimizing the amount of *waste rock* material and ensuring operational pit wall stability. See also *stripping ratio*.

**Unavailable Acid Potential** - The portion of the *acid potential* that is unable to generate *acid* because it is physically occluded. Occlusion may result from the precipitation of surface coatings or a *mineral's* occurrence within a larger *mineral*, in the interior of a *particle* or beneath the surface of *mine* walls. Depends on various factors, including the type of material (e.g. *tailings*, *waste rock* or *mine* wall) and the degree to which *minerals* contributing to the measured *acid potential* (AP) are physically occluded in *coarse fragments* or *rock* walls. Physical occlusion could be temporary and therefore the *unavailable AP* may vary with time. See also *effective acid potential* and *insufficiently reactive acid potential*.

**Unavailable Neutralization Potential** - The portion of the *neutralization potential* that is unable to neutralize acidity and maintain a *near-neutral drainage pH* because it is physically occluded. Occlusion may result from the precipitation of surface coatings or a *mineral's* occurrence within a larger mineral, in the interior of a *particle* or beneath the surface of minewalls. Unavailable or *insufficiently reactive NP* can be predicted from the NP measured in materials that are just about to and have just gone *acid*. See also *effective and insufficiently reactive neutralization potential*.

**Uncertain Future Net Drainage pH** - *Net-neutral* or *alkaline* material with uncertainty whether future *pH* of *drainage* will be net *acidic*, due to inadequate test work or geochemical conditions, such as an NPR between 1 and 2, where even extensive test work is unable to resolve whether *acidic drainage* will occur in the future.

**Unconsolidated Surficial Material** - See *non-lithified materials*.

**Underground Workings** - Any *anthropogenic* underground excavation, including *adits*, *crosscuts*, *declines*, *drifts*, *inclines*, *levels*, *portals*, *raises* and *shafts*. Also referred to as galleries in some countries. An alternative to *open pit mines*.

**Volatilization** - The change of a solid or liquid to a gas or vapour.

**Wall Washing** - Generic term for in-field *kinetic test* involving periodic rinsing of *mine* walls by water. Standardized in Canada as the MEND Minewall Technique.

**Wash Plant** - Coal preparation facility where saleable coal is separated from impurities using *comminution* and *specific gravity* differences (for example, breakers, heavy media separation and sieving). After cleaning, the coal is typically dried. Waste byproducts include *coarse* and *fine (tailings) refuse*.

**Waste Handling** - See *material handling*.

**Waste Rock** - Rock with insufficient amounts of economically valuable elements to warrant its extraction, but which has to be removed to allow physical access to the *ore*. *Waste rock* is typically blasted into smaller *particles* to allow its removal by truck and shovel. Disposal occurs in *sub-aerial* or *subaqueous* surface *dumps* or *backfill* to *open pits* or *underground workings*. In *heap leaching*, spent *ore* is sometimes referred to as *waste*

*rock*. In coal mining, *waste rock* may be referred to as “*spoils*”, “*gob*”, or “*rejects*”, terms which can also apply to waste materials from the density separation and the *wash plant*. See also *coarse refuse*, *fine refuse* and *mined-rock piles*.

**Waste Rock Dump** - A *mined rock pile* containing *waste rock*.

**Water Balance** - A term used in the context of mining to describe an inventory of *drainage* inputs and outputs, water volumes and the rate of flow. The water balance should be provided for each *mine component* that is an *ML/ARD* concern and for the site as a whole, at selected periods throughout the *mine*'s history.

**Water Quality** - Chemical and physical properties defined by measurable attributes of water, *sediment* and aquatic life, compared to a standard or criterion. See also *drainage chemistry* and *receiving environment objectives*.

**Water Quality Criteria** - Maximum or minimum values of physical, chemical or biological characteristics of water, biota or *sediment* whose exceedance under specified conditions may result in detrimental effects to a water use. Include numerical concentration or narrative statement established by the province for both organic and inorganic *contaminants* for a variety of water uses. See also *water quality objective*.

**Water Quality Objective** - A numerical concentration or narrative statement established to support and protect the designated uses of water at a specified site. Established based on site specific physical, chemical and biological conditions, with an adequate degree of safety and taking local circumstances into account. Often *water quality criteria* are adapted to protect the most sensitive designated water use at a specified location. See also *water quality criteria*.

**Water Table** - The elevation at which the fluid pressure is equal to atmospheric pressure in an unconfined aquifer with horizontal flow. The surface separating the vadose zone (where water is held under tension) from the saturated zone (where fluid pressures are greater than zero). The level to which water will rise in a well, just penetrating the saturated zone.

**Weathering** - The processes by which *particles*, *rocks* and *minerals* are altered on exposure to surface temperature and pressure and atmospheric agents such as air, water and biological activity.

**Wetlands** - Land where *soils* are water saturated for a sufficiently prolonged period of time such that excess water and resulting low *soil* oxygen levels are the principle determinants of vegetation and *soil* development.

**Whole-Rock Elemental Analysis** - *Assays* which measure the total concentration of cations in the solid phase. Common procedures include XRF and wet chemical digestion methods. Concerns include accuracy, detection limits and, for wet chemical digestion, the potential for incomplete digestion.