

TRANSPORTATION RESEARCH

CIRCULAR

Number E-C126

June 2008

Surface Transportation Weather *and* Snow Removal and Ice Control Technology

*Fourth National Conference on
Surface Transportation Weather*

*Seventh International
Symposium on Snow Removal
and Ice Control Technology*

June 16–19, 2008

TRANSPORTATION RESEARCH BOARD
OF THE NATIONAL ACADEMIES

**TRANSPORTATION RESEARCH BOARD
2008 EXECUTIVE COMMITTEE OFFICERS**

Chair: Debra L. Miller, Secretary, Kansas Department of Transportation, Topeka
Vice Chair: Adib K. Kanafani, Cahill Professor of Civil Engineering, University of California, Berkeley
Division Chair for NRC Oversight: C. Michael Walton, Ernest H. Cockrell Centennial Chair in Engineering, University of Texas, Austin
Executive Director: Robert E. Skinner, Jr., Transportation Research Board

**TRANSPORTATION RESEARCH BOARD
2008–2009 TECHNICAL ACTIVITIES COUNCIL**

Chair: Robert C. Johns, Director, Center for Transportation Studies, University of Minnesota, Minneapolis
Technical Activities Director: Mark R. Norman, Transportation Research Board

Paul H. Bingham, Principal, Global Insight, Inc., Washington, D.C., *Freight Systems Group Chair*
Shelly R. Brown, Principal, Shelly Brown Associates, Seattle, Washington, *Legal Resources Group Chair*
Cindy Burbank, National Planning and Environment Practice Leader, PB, Washington, D.C., *Policy and Organization Group Chair*
James M. Crites, Executive Vice President, Operations, Dallas–Fort Worth International Airport, Texas, *Aviation Group Chair*
Leanna Depue, Director, Highway Safety Division, Missouri Department of Transportation, Jefferson City, *System Users Group Chair*
Arlene L. Dietz, C&A Dietz, LLC, Salem, Oregon, *Marine Group Chair*
Robert M. Dorer, Deputy Director, Office of Surface Transportation Programs, Volpe National Transportation Systems Center, Research and Innovative Technology Administration, Cambridge, Massachusetts, *Rail Group Chair*
Karla H. Karash, Vice President, TranSystems Corporation, Medford, Massachusetts, *Public Transportation Group Chair*
Mary Lou Ralls, Principal, Ralls Newman, LLC, Austin, Texas, *Design and Construction Group Chair*
Katherine F. Turnbull, Associate Director, Texas Transportation Institute, Texas A&M University, College Station, *Planning and Environment Group Chair*
Daniel S. Turner, Professor, University of Alabama, and Director, University Transportation Center for Alabama, Tuscaloosa, *Operations and Maintenance Group Chair*

TRANSPORTATION RESEARCH CIRCULAR E-C126

Surface Transportation Weather *and* Snow Removal and Ice Control Technology

**Fourth National Conference on
Surface Transportation Weather**

**Seventh International Symposium on
Snow Removal and Ice Control Technology**

June 16–19, 2008

Indianapolis, Indiana

Sponsored by

Transportation Research Board of the National Academies

In Cooperation with

Indiana Department of Transportation

American Association of State Highway and Transportation Officials

Federal Highway Administration

June 2008

Transportation Research Board

500 Fifth Street, NW

Washington, DC 20001

www.TRB.org

TRANSPORTATION RESEARCH CIRCULAR E-C126

ISSN 0097-8515

The **Transportation Research Board** is one of six major divisions of the National Research Council, which serves as an independent adviser to the federal government and others on scientific and technical questions of national importance. The National Research Council is jointly administered by the National Academy of Sciences, the National Academy of Engineering, and the Institute of Medicine. The mission of the Transportation Research Board is to provide leadership in transportation innovation and progress through research and information exchange, conducted within a setting that is objective, interdisciplinary, and multimodal.

The **Transportation Research Board** is distributing this Circular to make the information contained herein available for use by individual practitioners in state and local transportation agencies, researchers in academic institutions, and other members of the transportation research community. The information in this Circular was taken directly from the submission of the authors. This document is not a report of the National Research Council or of the National Academy of Sciences.

Surface Transportation Weather Task Force

Wilfrid A. Nixon, *Chair*

Richard J. Nelson and Richard Wagoner, *Vice Chairs*

Roemer Alfelore	Christopher Flanigan	Peter P. Neilley	Joseph Perrin, Jr.
Roya Amjadi	Tina Greenfield	Jim O'Sullivan	Panos D. Prevedouros
William M. Browder	Arthur L. Handman	Jan Olander	Adel W. Sadek
James D. Colyar	Keishi Ishimoto	Leon F. Osborne, Jr.	Kathy Strebe
Frank L. Estis	Sandra Q. Larson	Max S. Perchanok	

Surface Transportation Weather Program Subcommittee

Wilfrid A. Nixon	Roemer Alfelore	Peter P. Neilley	Leon F. Osborne, Jr.
------------------	-----------------	------------------	----------------------

Winter Maintenance Committee

John P. Burkhardt, *Chair*

Joseph Brett Althouse	Charles C. Goodhart	L. David Minsk	Sean M. Riley
Roya Amjadi	Richard L. Hanneman	Tony Myhra	Noriyuki Sato
Richard M. Balgowan	Yasuhiko Kajiya	Richard J. Nelson	Xianming Shi
Lisa Ballard	Patrick Kennedy	Wilfrid A. Nixon	Leland D. Smithson
Dennis W. Belter	Dennis A. Kroeger	Jan Olander	Gregory E. Thompson
Pete F. Costello	David A. Kuemmel	Max S. Perchanok	Torgeir Vaa
Tim Croze	Chan-young Lee	Thomas E. Pericak	Donald M. Walker
Rand Decker	Mikko Malmivuo	Lin Qiu	Yetkin Yildirim

Snow Removal and Ice Control Technology Program Subcommittee

John P. Burkhardt	Richard L. Hanneman	William Mahoney
Dennis W. Belter		Wilfrid A. Nixon

Frank N. Lisle, *TRB Staff Representative*

Transportation Research Board

500 Fifth Street, NW
Washington, DC 20001

www.TRB.org

Ann E. Petty, Production Editor; Jennifer Corro, Proofreader and Layout; Jennifer J. Weeks, Manuscript Preparation; Mary McLaughlin, Jennifer Merrill Thompson, and Deborah Uffelman, Proofreaders

Preface

The 4th National Conference on Surface Transportation Weather was held on June 16–17, 2008, and the 7th International Symposium on Snow and Ice Control on June 17–19, 2008, in Indianapolis, Indiana. The conference was conducted by the Transportation Research Board (TRB) Task Force on Surface Transportation Weather, and the symposium, by the Winter Maintenance Committee, in cooperation with Indiana Department of Transportation, AASHTO, and FHWA. This conference and symposium included papers and presentations on the application of weather information in transportation agencies; snowplow operations; maintenance decision support systems; modeling and forecasting weather in surface transportation; data collection and assessing technologies; impact of weather on traffic operations; weather information for drivers; environmental stewardship; blowing snow; pavement surface temperature; surface friction measurement; and characteristics of materials. Maintenance managers, engineers, and researchers from the following countries presented their papers: Canada, Denmark, France, Germany, Japan, Norway, Sweden, Switzerland, and the United States. The papers were not subjected to the TRB peer review process.

Contents

NATIONAL PERSPECTIVES AND ASSESSING TECHNOLOGIES

A New Paradigm in Observing the Near Surface and Pavement: *Clarus* and Vehicle Infrastructure Integration (Weather08-012)3
Paul A. Pisano, Patrick J. Kennedy, and Andrew D. Stern

Winter Operations in View of Vision Zero (Snow08-041).....16
Torgeir Vaa and Åge Sivertsen

Proposed Test Bed for Surface Transportation Weather Technologies (Weather08-025)27
Mark A. Askelson and Leon F. Osborne, Jr.

MODELING AND FORECASTING TEMPERATURE IN SURFACE TRANSPORTATION

Modeling Rail Temperature with Real-Time Weather Data (Weather08-001)37
Yu-Jiang Zhang and Sung Lee

The Road Temperature Forecast Tool (Weather08-009)49
Daniel Bättig

Spatial and Temporal Mapping of Pavement Temperatures for Optimal Winter Road Maintenance Operations (Snow08-035A).....57
L. Fu, B. Hashemloo, F. Feng, and Max S. Perchanok

Night Icing Potential Demonstration Project (Snow08-045).....58
Paul J. DeLannoy, Shawn Allan, Terry M. Bullock, John D. McClintock, Greg Moffatt, David Robbins, Robert Sayer, Philip Woodhams, Paul Richard, and Bernie MacDonald

CHARACTERISTICS OF MATERIALS

Eutectic Depressants: Relationship of Eutectic, Freezing Point, and Ice Melting Capacity in Liquid Deicers (Snow08-008)73
Scott Koefod

The Amount of Salt on Road Surfaces After Salt Application: A Discussion of Mechanisms and Parameters (Snow08-013).....85
Kai Rune Lysbakken and Harald Norem

**Wet Dust Sampler: Technological Innovation for Sampling
Particles and Salt on Road Surface** (Snow08-028).....102
Per Jonsson, Göran Blomqvist, and Mats Gustafsson

**Numerical Evolution of Deicer Amount on Pavement Surface:
Traffic and Weather Influences** (Snow08-046).....112
*Mario Marchetti, Rodolphe Duval, Jean Livet, Maurice François,
Philippe Pecquenard, and Pierre Guillevic*

USING WEATHER INFORMATION TO IMPROVE TRAFFIC SAFETY

**Comprehensive Winter Maintenance Management System to
Increase Road Safety and Traffic Flow** (Snow08-052)127
Thorsten Cypra

Advanced Road Safety and Weather Warning System (Weather08-007)140
Paul G. Knight, Jonathan Agüero-Valverde, and Paul P. Jovanis

Improving Traffic Safety Under Adverse Weather Conditions (Weather08-018A).....155
Charla Gaskins, Nathan Huynh, and Emmanuel U. Nzewi

ENVIRONMENTAL STEWARDSHIP

**Winter Model: Roadside Salt Exposure Under
Different Weather Conditions** (Snow08-026)159
Göran Blomqvist and Mats Gustafsson

Impacts of Magnesium Chloride-Based Deicers on Roadside Vegetation (Snow08-050)....171
Nicole A. Trahan and Curt M. Peterson

Road Dust and Air Quality in Sweden (Snow08-027).....187
Mats Gustafsson, Göran Blomqvist, and Per Jonsson

MAINTENANCE DECISION SUPPORT SYSTEMS

**Providing Winter Road Maintenance Guidance: An Update of the
Federal Highway Administration Maintenance Decision Support System** (Snow08-019)..199
*Kevin R. Petty, William P. Mahoney III, James R. Cowie, Arnaud P. Dumont, and
William L. Myers*

Development of Winter Maintenance Support System: Overview and Status (Snow08-022)	215
<i>Naoto Takahashi, Roberto A. Tokunaga, and Motoki Asano</i>	

An Overview of Implementation and Deployment of the Pooled Fund Study Maintenance Decision Support System (Snow08-038)	229
<i>Robert D. Hart, John J. Mewes, Benjamin W. Hershey, Leon F. Osborne, Jr., and David L. Huft</i>	

Maintenance Decision Support System Is Not Just for State Departments of Transportation (Snow08-029)	240
<i>William (Pat) Kennedy</i>	

SNOWPLOW OPERATIONS AND EQUIPMENT

The High-Speed–Environmental Snowplow (Snow08-025)	253
<i>Pontus Gruhs</i>	

Plowing Wider and Faster on 21st-Century Highways by Using 14-ft Front Plows and Trailer Plows Effectively (Snow08-003)	261
<i>Robert Glenn Lannert</i>	

Global Positioning System–Controlled Salt Spreading: From Idea to Implementation (Snow08-030)	267
<i>Freddy Knudsen and Bo Sommer</i>	

Tools to Gain Faster Snow and Ice Response While Ensuring Preservation of Equipment: Especially with Part-Time or Seasonal Snowplow Operators (Snow08-009)	273
<i>Larry E. Nelson</i>	

APPLICATION OF WEATHER INFORMATION IN TRANSPORTATION AGENCIES

Guidance for Creating and Maintaining Written Snow and Ice Control Plan and Policy Documents (Snow08-001)	287
<i>Duane E. Amsler, Sr.</i>	

Follow-Up Study of Winter Standard as a Research and Development Project (Snow08-042)	304
<i>Torgeir Vaa and Ivar Hol</i>	

Integrating Weather into Transportation Operations: A Utah Department of Transportation Case Study (Weather08-005)	318
<i>Christopher K. Strong and Xianming Shi</i>	

ROLE OF SURFACE FRICTION IN WINTER MAINTENANCE

An Approach to Terrain Classification to Improve Road Condition Forecasts of Maintenance Decision Support Systems Forecasts (Snow08-039)	337
<i>Max S. Perchanok</i>	

A Probabilistic Model for Discriminating Road Surface Conditions Based on Friction Measurement (Snow08-033A)	351
<i>L. Fu, F. Feng, and Max S. Perchanok</i>	

A Feasibility Study on Friction for Winter Road Management (Snow08-020)	352
<i>Roberto A. Tokunaga, Makoto Funahashi, Naoto Takahashi, and Motoki Asano</i>	

Measurements of Pavement Condition and Road Weather Environment Within North Dakota Using a Tow-Hitch Mount Road Grip Tester (Snow08-016)	364
<i>Jeffrey S. Tilley, Scott S. Kroeber, Jennifer Green, Diana Clonch, and Don Halliday</i>	

BLOWING AND DRIFTING SNOW

The Physical Nature and Prediction of Blowing Snow Within the Roadway Environment (Snow08-018)	381
<i>Benjamin W. Hershey and Leon F. Osborne, Jr.</i>	

Geospatial Variability of Roadway Vegetation and Blowing Snow (Snow08-031)	393
<i>Scott S. Kroeber, Damon M. Grabow, and Leon F. Osborne, Jr.</i>	

Spatial Modeling for Evaluation and Remediation of Snow Drifting on Ontario Highways (Snow08-036A)	403
<i>Max S. Perchanok, Steve McArdle, Patrick Grover, and Aleksey Naumov</i>	

WEATHER SENSORS AND DATA COLLECTION

Noninvasive Road Weather Sensors (Weather08-002)	407
<i>Paul Bridge</i>	

Using the Probe Vehicle to Gather Information on Visibility in Snowstorms (Snow08-006)	416
<i>Masaru Matsuzawa, Yasuhiko Kajiya, Yuma Matsuyama, Takashi Nishida, and Yasuhiro Nagata</i>	

Operational Considerations in the Integration of Technologies for Automated Vehicle Location and Mobile Data Collection into Decision Support Systems for Maintenance and Operations (Snow08-037)	429
<i>John J. Mewes, Robert D. Hart, Benjamin W. Hershey, Leon F. Osborne, Jr., and David L. Huft</i>	

RELATIONSHIPS BETWEEN WEATHER EVENTS AND TRAFFIC OPERATIONS

Toward Weather-Responsive Traffic Management on French Motorways (Weather08-014)	443
<i>Nour-Eddin El Faouzi, Olivier de Mouzon, and Romain Billot</i>	

Long-Term Analysis of Reductions in Traffic Volume Across New Hampshire During Winter Storms (Weather08-011)	457
<i>Melissa Grace Wellman, Samuel Miller, Stephen Gray, and Joseph Zabransky</i>	

Impact of Snow on Video Detection Systems at Signalized Intersections (Weather08-013)	469
<i>Juan C. Medina, Madhav V. Chitturi, and Rahim F. Benekohal</i>	

RELATIONSHIPS BETWEEN WINTER SERVICE AND WEATHER

Modeling Winter Maintenance Activities Using Classification Trees (Weather08-010)	483
<i>Jean Andrey, Alexander Brenning, Denis Kirchhoff, Brian Mills, and Max S. Perchanok</i>	

The Possibility of Implementing the Management Cycle of Winter Maintenance by Performance Measurement (Snow08-007)	499
<i>Motoki Asano and Roberto A. Tokunaga</i>	

Winter Model: Road Condition Submodel (Snow08-011)	512
<i>Staffan Möller</i>	

Estimating the Relationship Between Snow and Ice Maintenance Performance and Current Weather Conditions (Snow08-053)	519
<i>Thomas H. Maze, Massiel A. Orellana, Alicia Carriquiry, and Chris Albrecht</i>	

WEATHER AND PAVEMENTS

- Physical Processes That Affect Runway Surface Conditions During Winter Time: A Conceptual Model** (Snow08-014)537
Alex Klein-Paste
- The Pavement Precipitation Accumulation Estimation System** (Snow08-017).....544
Mark A. Askelson
- Temperature and Precipitation Sensitivity Analysis on Pavement Performance** (Weather08-019).....558
James T. Smith, Susan L. Tighe, Jean Andrey, and Brian Mills
- SafeLane Overlay Performance Testing: Winter 2005–2006** (Snow08-004)572
Wilfrid A. Nixon

PROVIDING WEATHER INFORMATION TO IMPROVE DRIVER DECISIONS

- Personal Weather Advisor: Providing Drivers with In-Vehicle, Real-Time Weather Awareness** (Weather08-008A)585
Daniel R. Gallagher, Bob Baron, Bob Dreisewerd, John McHenry, and Don Olerud
- A Study on the Expression of Winter Road Information and Its Effects on Drivers' Travel Decision Making** (Snow08-021).....586
Yasuhiko Kajiya, Yasuaki Matsuda, and Tetsuro Matsushima
- Driving Decisions Related to the Colorado Front Range Winter Storm, December 20–21, 2006** (Weather08-023).....597
Sheldon Drobot

WINTER EVENTS, FOG, AND PERFORMANCE MEASURES

- The Role of Risk, Reliability, and Probability in the Interaction of Weather and Surface Transportation** (Weather08-016A)611
Wilfrid A. Nixon
- Fog Forecast Provision Experiment for a Mountain Pass** (Snow08-024)612
Yuma Matsuyama, Tatsuo Miyoshi, Matsuda Yasuaki, Masaru Matsuzawa, and Yasuhiko Kajiya
- Performance Measures for Snow and Ice Control Operations** (Snow08-051)625
Thomas H. Maze, Chris Albrecht, and Dennis A. Kroeger

BENEFITS AND COSTS OF WINTER MAINTENANCE

**Benefits and Costs Associated with
Maintenance Decision Support Systems (Weather08-004A)**.....641
Christopher K. Strong and David L. Huft

**A Snow Removal Cost Estimation Model Using the Snow
Removal Unit Cost Curve (Snow08-044)**642
Shigeyuki Nakamae, Junichi Oshima, Takahiro Okawado, Fumihiro Hara, and Shin-ei Takano

APPENDIX: Author Contact Information.....655

National Perspectives and Assessing Technologies

NATIONAL PERSPECTIVES AND ASSESSING TECHNOLOGIES

A New Paradigm in Observing the Near Surface and Pavement *Clarus and Vehicle Infrastructure Integration*

PAUL A. PISANO

PATRICK J. KENNEDY

Federal Highway Administration

ANDREW D. STERN

Noblis, Inc.

The nation's weather enterprise generally relies on a network of a couple thousand automated weather observing stations to sense and report on the state of the lower atmosphere. These stations are typically situated in pristine fields adjoining airport runways. And while these stations fulfill the requirements for airport ground operations, they do little to report accurately on pavement and near surface conditions on the nation's roads. The FHWA is doing something about this data coverage gap through two initiatives: *Clarus* and Vehicle Infrastructure Integration (VII). First, the *Clarus* Initiative seeks to maximize the utility of road weather observations by running quality checks on the data and then disseminating the observations to the weather and transportation communities. The *Clarus* Initiative involves the creation of an advanced data management system that will be able to assimilate all environmental sensor station observations across North America and provide quality-checked road weather observations for any user. The second initiative involves utilizing passenger vehicles as mobile weather probes. The VII Initiative is based on having automobile manufacturers equip cars with onboard units and transceivers that are capable of collecting snapshots of dozens of onboard systems (e.g., windshield wiper state or outside air temperature) and transmitting these data to a national communications infrastructure. Successful deployment of such a national system could result in the generation of millions of new vehicle-based observations that could reveal new details about the state of the atmosphere at the driver's level and conditions on the pavement surface. This paper provides details on the progress of both the *Clarus* and VII Initiatives, which have the potential to change the way that the nation observes and manages surface weather data.

The National Oceanic and Atmospheric Administration (NOAA) National Weather Service (NWS) tracks and categorizes the number of fatalities that are attributed to adverse weather each year (1). Figure 1 shows that on average, for the 10-year period ending in 2006, 650 people are killed in adverse weather. Many of these deaths are associated with major weather events, such as a landfalling hurricane or a major winter storm, that may have a national impact.

A much less discussed statistic is the number of people killed in automobile crashes during adverse weather each year. Many deaths occur as single-incident fatalities and often receive little press. The NHTSA has shown that during the 11-year period from 1995 to 2005, 1.57 million weather-related crashes each year, there are 690,000 injuries and 7,400 fatalities (2). This last value is more than 10 times larger than all of the weather-related fatalities tracked by the NWS combined.

The FHWA Road Weather Management (RWM) program believes that these statistics are unacceptable and has initiated numerous programs to reduce fatalities and to promote safety

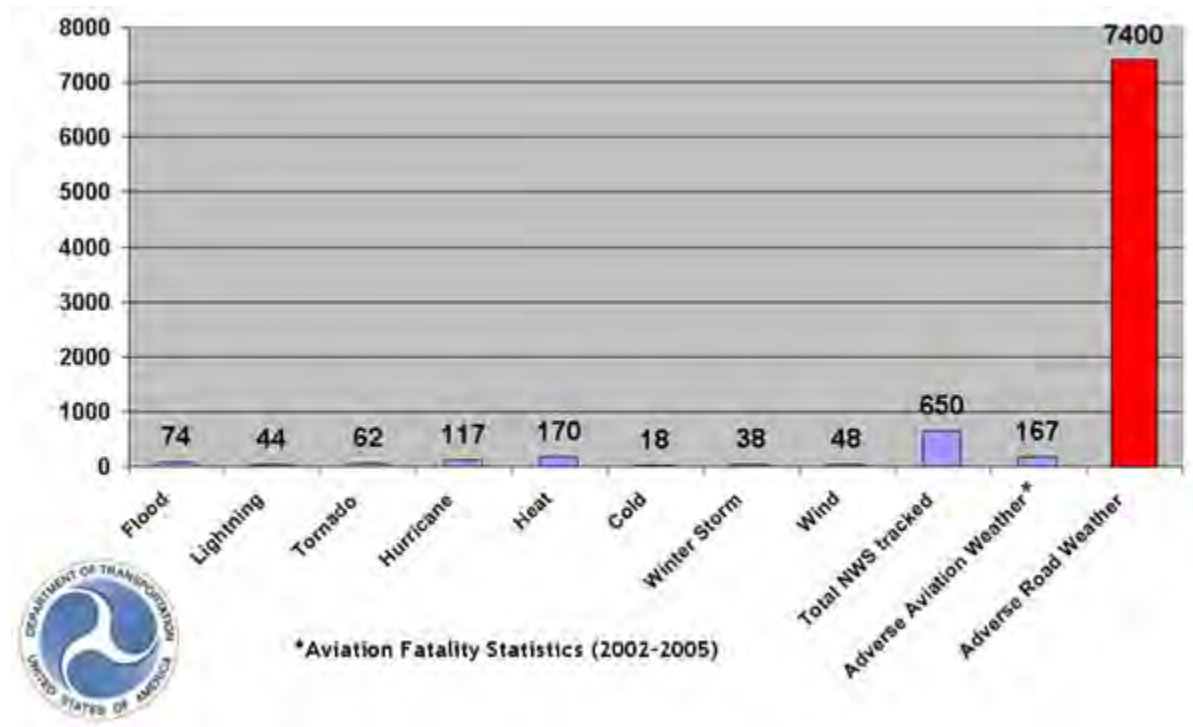

FIGURE 1 Average annual weather-related fatalities for the United States. Statistics for weather categories (from “Total NWS Tracked” and to the left are from the National Weather Service U.S. Natural Hazards Statistics web page) are for the 10-year period ending in 2006. Aviation fatality statistics are from the FAA for the 2-year period ending in 2005. Road weather fatality statistics are from NHTSA for the 11-year period ending in 2005.

on the nation’s roadways. Two initiatives, *Clarus* and Vehicle Infrastructure Integration (VII), will be discussed.

THE CLARUS INITIATIVE

For the past several decades, environmental observing networks have grown in number, sophistication, and level of detail. However, rather than concentrating on surface conditions, most observational networks focus their instrumentation, observations, and resulting products in the atmospheric (aboveground) domain. Well-established research initiatives (such as the FAA’s Aviation Weather Research Program) have contributed to a significant reduction in weather-related plane crashes, and the increased meteorological knowledge has resulted in better aviation forecasts and warnings.

In contrast, the efforts to invest in observations and products focused on the near surface, pavement surface, and subsurface have been inconsistent, less organized, and only modestly funded, mostly via limited state resources. Federal administration of surface observation programs focused on the aviation community and the deployment of runway (ground) sensors at some airports. As a result, state departments of transportation (DOTs) had to invest in

environmental sensor stations (ESS) to obtain weather and pavement conditions along their road networks. Most ESS are field components of Road Weather Information Systems (RWIS). These ESS are deployed along roadways and other transportation facilities to provide their agencies with observations on surface conditions to improve safety and mobility on the nation's roads.

The current challenge is that the available sources of RWIS data are not managed to develop a comprehensive and coherent picture of conditions in the surface transportation domain. Other stakeholder communities outside transportation, such as agriculture, water management, and power utilities, have made similar investments to compensate for their lack of surface observations and data management capabilities. The end result is a mosaic of discrete observation points owned by various public and private entities without interaction with the greater community.

In 2003, the FHWA approached the National Academy of Sciences (NAS) and described the problems and challenges. In 2004, it responded with its landmark report, "Where the Weather Meets the Road: A Research Agenda for Improving Road Weather Services" (3). In the report, NAS acknowledged the troubling statistics associated with weather-related vehicle fatalities and recommended that the nation invest in a robust, integrated road weather observational network and database management system. This visionary idea was the impetus for the *Clarus* Initiative.

The *Clarus* System

Clarus, which means "clear" in Latin, is a data management system for the collection, quality checking, and dissemination of surface transportation-related observations from North America. Figure 2 shows a timeline of the *Clarus* system development process. From 2004 into 2006, the *Clarus* system progressed through a rigorous systems engineering process that extended from concept of operations development and requirements gathering to design and implementation. All engineering documents can be found at the *Clarus* Initiative website, www.Clarusinitiative.org.

One of the most important developmental activities associated with *Clarus* was the creation of a group of interested practitioners who would be used as a resource throughout the Initiative. Coined as the Initiative Coordinating Committee (ICC), this multidisciplinary group of stakeholders from the public, private, and academic communities across the transportation and weather sectors participated in the requirements gathering process and served as evaluators of design documents and as members of subject-specific task forces. These task forces dealt with a number of issues ranging from reviewing the foundational concept of operations documentation to metadata collection and data dissemination policies.

Once the *Clarus* system was built and operating, a proof-of-concept (PoC) demonstration was held during the fall of 2006 in three states: Alaska, Minnesota, and Utah. The PoC showed that state DOTs could provide both data files and station metadata to the *Clarus* system. The demonstration also showed that each of the processing modules functioned properly, allowing for the parsing, caching, and quality checking of hundreds of observational fields.

By the end of 2006, initial development and testing of the *Clarus* system was successfully completed. Its internal memory and database was designed to cache millions of observations for a period of 1 week. The next steps were to create a web portal to make interacting with the system easier and to begin populating the database with ESS observations from across the continent.

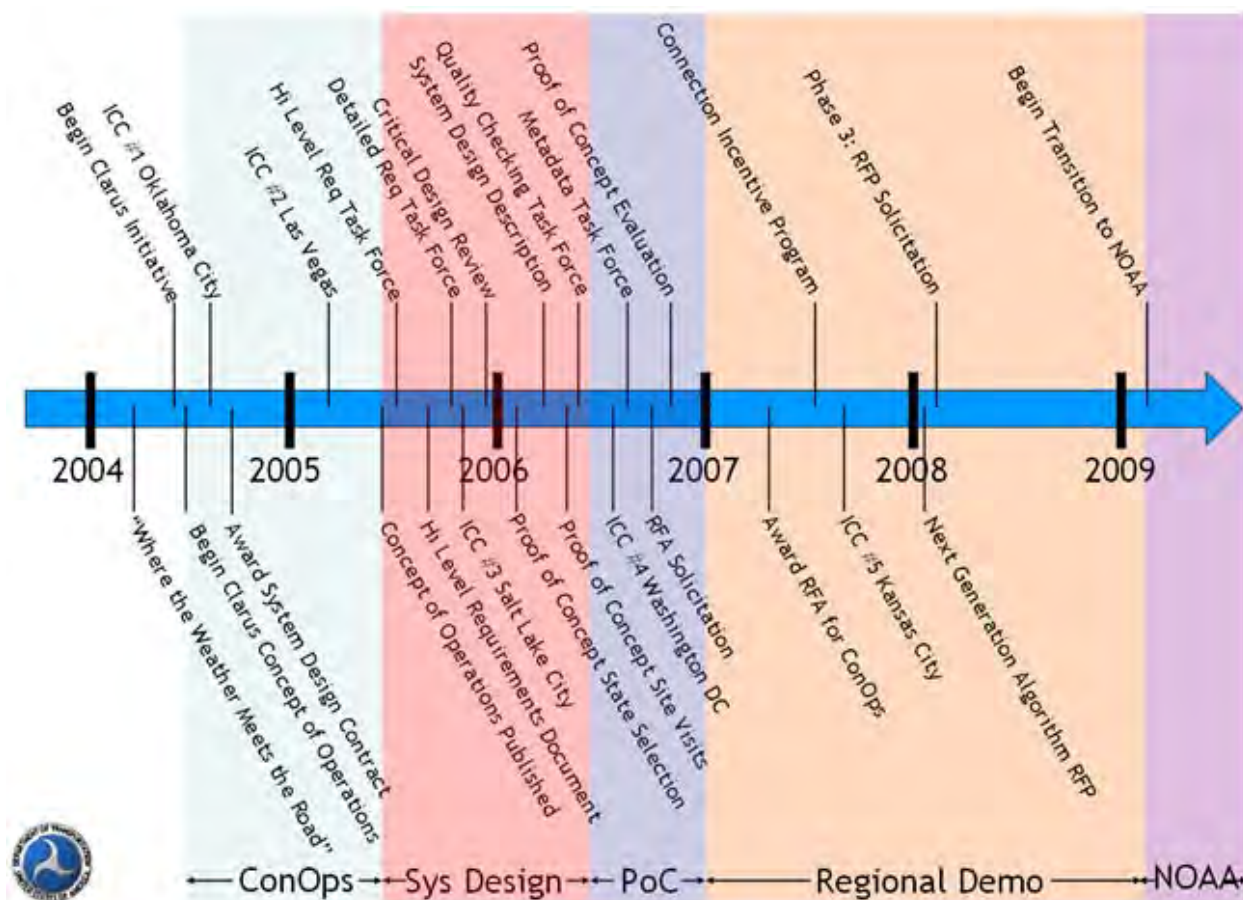

FIGURE 2 Timeline of the *Clarus* Initiative extending from the vision for the project (from the NAS study) to the eventual transition to operations. The transition to NOAA may take through 2011 to complete.

The *Clarus* Graphical User Interface

To facilitate use of the *Clarus* system and to promote data exploration, a simple graphical user interface (GUI) was developed. The GUI, which can be accessed on the web at Clarus.mixonhill.com, provided an easy way to retrieve and visualize the ESS data. The home page for *Clarus*, shown in Figure 3, provides access to state DOT ESS data through links. A series of menu-driven queries allows users to access observations from individual stations or entire states from one point in time to a large time window.

The GUI provides for easy spatial visualization of the ESS data by using Google Maps geonavigation tools. As an example, Figure 4 displays air temperature data from ESS sites in Minnesota. The purple “thumb tacks” indicate that current data are available in the system. Gray thumb tacks show where the current receipt of data has been interrupted or stopped. This may be an indication of sensor failure or a communications problem.



FIGURE 3 Home page for the *Clarus* system can be found at clarus.mixonhill.com before the transition to NOAA. This web portal allows access to the Google Maps-based GUI and to the cache for data exploration.

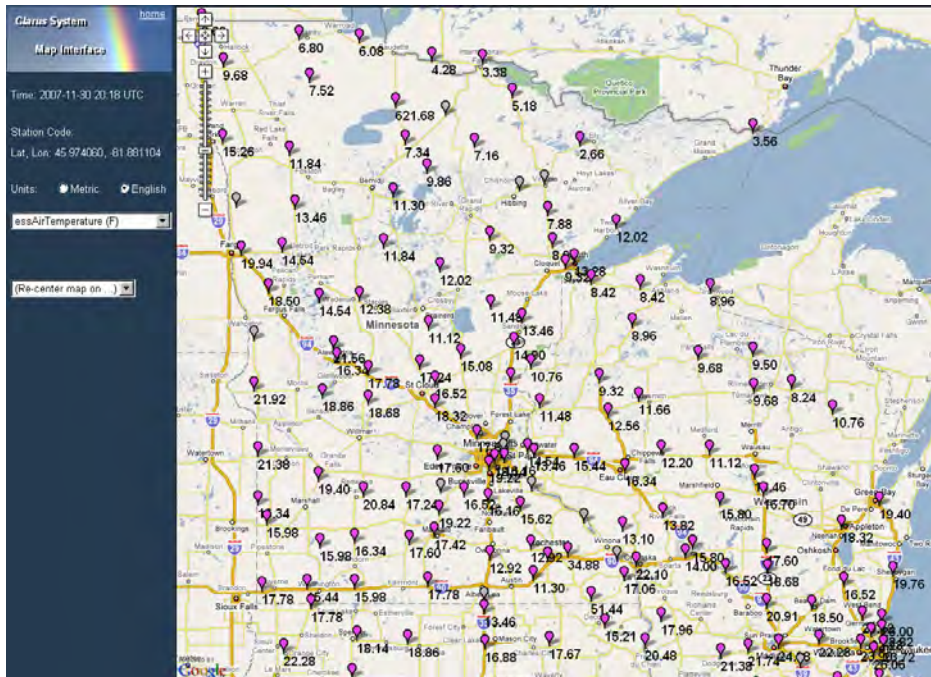

FIGURE 4 A *Clarus* display using Google Maps as the display tool. In this example, air temperature data from Minnesota DOT and Wisconsin DOT ESS are shown in degrees Fahrenheit.

Quality checking output and location-specific metadata can be easily displayed from the GUI. Figure 5 shows the result of clicking on a purple thumb tack. All of the observation fields are shown in a table. Quality checking algorithm titles can be seen along the top. Within the table matrix, green circles represent a quality checking test that passed. A red X indicates that the results of the quality checking test were beyond thresholds set within the metadata. Receipt of a failure icon does not necessarily mean that the data or sensors are bad. It does, however, provide an easy way for state DOT ESS administrators or even end users to spot sites that may require additional investigation.

The *Clarus* system also allows for the creation of subscriptions through the GUI. A subscription is a convenience process that can be used primarily with automated data retrieval systems. Once a subscription has been invoked, a selected group of observations will be placed into a protected directory at a known time interval. Hence, an external data collection system would be able to retrieve only the most recent observations for a specific time period from one constant web address.

The GUI is for demonstration and familiarity purposes only. The portal does not provide any value-added information or content. It is expected that external interests in the weather enterprise will eventually construct a much more sophisticated Web portal. In fact, the FHWA is even aiding in this process through a project called the *Clarus* multistate regional demonstration.

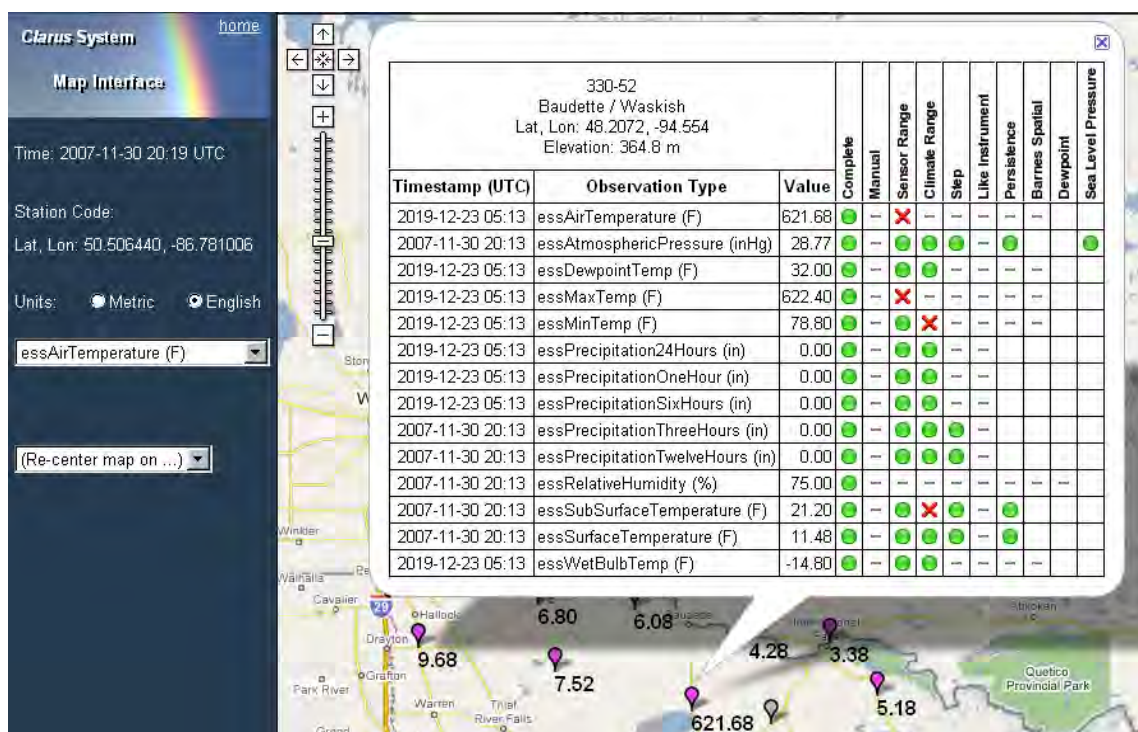

FIGURE 5 The GUI allows users of the *Clarus* system to monitor the results of the quality checking tests. In this example, the test names are shown vertically along the top of the displayed table. Test results are shown as green circles (passed), red X's (failed), and dashes (not scheduled to run for this sensor). A failed result may mean that a sensor is bad, or it could mean that there are metadata threshold problems or communications issues.

***Clarus* Multistate Regional Demonstrations**

During the second half of 2006, as the *Clarus* system was undergoing its PoC demonstration and evaluation, the FHWA introduced to the stakeholder community a series of activities which are called the *Clarus* multistate regional demonstrations. Through the demonstrations, FHWA aims to achieve the following objectives:

1. Demonstrate that the *Clarus* system functions as designed by incentivizing a large number of state and local agencies to contribute data from their ESS networks;
2. Enable proactive transportation system management through utilization of the *Clarus* System; and
3. Provide an environment so that the private sector and academic organizations can innovate and create new and improved products that will benefit the public, academia, and the entire weather enterprise.

The *Clarus* multistate regional demonstrations contained three distinct phases. The phases were

- Phase 1. Concept of operation (ConOps) development,
- Phase 2. Connection Incentive Program (CIP), and
- Phase 3. Application development and deployment.

Phase 1. Concept of Operations Development

The first phase of the regional demonstrations contained two parts. In the first part, teams of state DOTs (or provincial transportation ministries) were to form teams along a common corridor (such as an interstate highway). The teams would need to develop a ConOps of business-to-government solutions which were enabled by utilization of the *Clarus* system. The ConOps could describe any number of innovative new products, services, algorithms, or systems that would improve surface transportation safety, mobility, or productivity. The second part of the first phase of the regional demonstration promoted the population of the *Clarus* database with transportation agency ESS data.

During late 2006, the FHWA issued a request for applications (RFA) from public transportation agencies. In early 2007, three groups of transportation agencies were selected for participation in the regional demonstrations. These groups were

Group 1. Northwest Passage. This team consisted of state DOTs along the I-90/I-94 corridor extending from Wisconsin through Minnesota, North Dakota, South Dakota, Wyoming, Montana, and Idaho to Washington State.

Group 2. ALCAN (Alaska–Canada). This team consisted of Alaska DOT, the provincial transportation ministries in Yukon, British Columbia, and Alberta and Environment Canada.

Group 3. Aurora Consortium. This team consisted of Aurora members along the I-80 corridor extending from Iowa to Illinois, Indiana, and Ohio.

ConOps documents from each of the groups were delivered to FHWA in January 2008. The use and disposition of the ConOps is explained below in the third phase of the regional demonstrations.

Phase 2. Connection Incentive Program

The second phase of the *Clarus* multistate regional demonstrations is the CIP. The objectives of the CIP are to both incentivize public transportation agencies into providing their ESS data (observations and metadata) to the *Clarus* System and to provide financial assistance to agencies to help offset some of the expenses associated with connecting to the *Clarus* system.

Funding has been set up to be streamlined in the form of federal grants to state DOTs. Funding can be used to offset travel expenses to each ESS for the purpose of collecting and organizing site and sensor metadata. To contribute ESS data to *Clarus*, a certain amount of metadata must be obtained and entered into the system. Specifics about required and optional metadata fields can be found on the *Clarus* Initiative website at www.Clarusinitiative.org/documents.htm under “Metadata Dictionary.”

Grant funds can also be used to procure hardware such as handheld Global Positioning System (GPS) units or digital cameras to aid in collecting and documenting site metadata. Funding can also be used to acquire a consultant to compile climate metadata or to have software developed to put ESS observations into a standard format (such as comma delimited text or XML).

Under the streamlined application process, transportation agencies need only create a technical plan and a financial plan. The technical plan affirms the agency’s eligibility to receive the funds and provides details about its ESS network. The financial plan provides expenditure details and includes information about the required 20% state match. Funds cannot be used to purchase new ESS sensors. The CIP will be available through the end of fiscal year 2008.

Phase 3. Application Development and Deployment

The third phase of the *Clarus* multistate regional demonstrations involves implementation of innovations that were included in Phase 1 ConOps documents. Each ConOps will undergo an internal evaluation at FHWA. Each concept within a ConOps will be evaluated based on

- Strengths and weaknesses,
- Similarities (with other proposals),
- The probability of successful completion, and
- The potential business model.

At the time this paper was written, the plan was to post a request for proposals (RFP) in late winter–early spring of 2008 for members of the weather enterprise to implement selected “concepts” within the ConOps documents. The companies will be given 24 months to work on implementation details, which include utilization of a full systems engineering process. Once a concept has been implemented, the new product or service will become the property of the participant company.

In addition to implementation activities, participants in Phase 3 will take part in an independent evaluation of the *Clarus* system.

Clarus Transition to Operations

NWS has been interested in the *Clarus* Initiative since its inception. It is working on creating a new operational processing system that collects, quality checks, and disseminates observations from a diverse set of platforms ranging from space-based (satellite data) to remotely sensed data (e.g., from radar, sounders, balloons, aircraft).

Observations from the surface, which includes airport automated systems and transportation ESS, are also planned for implementation. The transition from *Clarus* to the NWS operational system is expected to take place in 2011.

VII PROGRAM

All relatively new passenger vehicles on the road today contain small computers to monitor and control various systems such as engine combustion, antilock braking, and air bag deployment. What if the status of many onboard systems could be collected onboard and periodically transmitted to a roadside receiver? What if near real-time information could then be sent back to the originating vehicle to provide advice about weather or road conditions, traffic, and collision avoidance? These concepts are the basis for U.S. DOT's VII program.

Overview

The long-term objective of the VII program is to create an enabling communication infrastructure to support both vehicle-to-vehicle and vehicle-to-infrastructure communications in support of both safety and mobility applications. Safety applications will increasingly have an emphasis on developing a crash avoidance capability. Mobility will include obtaining better information (in both quality and in density) for roadway system management and operations. This includes the potential to observe and infer both driver-level weather and pavement conditions.

Current plans for VII are to use wireless communications based on the Federal Communication Commission's (FCC) allocation of 5.9 GHz radio frequency for implementing direct short-range communications (DSRC) (4). Use of this frequency would allow low-latency, reliable, and secure communications between vehicles and the roadside within approximately ½ mi of each roadside unit. A consortium of eight automobile manufacturers is working on common data and transmission formats. Inclusion of DSRC transponders in some new vehicles may begin as soon as the 2012 model year. There is, however, still a question of how many roadside units will be installed when VII-enabled vehicles hit the showroom floor. A sizable number of challenges face the VII program, including funding, private-sector participation, and privacy. All these challenges are being addressed by the managers of the VII program. The RWM program is focusing on the intersection of VII and weather.

Potential Data Elements

All VII-enabled cars will have a few capabilities in common:

- Each vehicle will have a transceiver to both transmit and receive data.

- Each vehicle must have a GPS capability to be able to report its location and heading.
- While not all vehicles will have the same type or amount of equipment onboard, a common, minimum set of data should be available for V2I communications (such as vehicle speed, windshield wiper state, and headlight state).
 - It will be up to the automobile manufacturers to design and implement a communications interface in the vehicle cabin to convey information with minimal distraction to the driver.

In addition to the basic elements listed above, [Figure 6](#) shows a potential list of all available vehicle-based data elements. Elements such as antilock braking system, vehicle stability control, and vehicle traction control could be used to infer pavement conditions and a friction index. Windshield wiper state and headlight state could infer the occurrence of precipitation. The windshield wiper rate and vehicle speed could infer precipitation rate. Exterior air temperature could infer precipitation type. These elements could easily be integrated with existing data sets (such as Doppler weather radar) to create more complete vehicle-based road weather observations (5).

According to current plans, data elements and status fields will be collected on the vehicle by a processor that polls each system during specific intervals. The polling intervals are controlled by certain events. Periodic collection of data elements will occur solely on the basis of the movement of the vehicle as an inverse function of its speed (6). A vehicle traveling at Interstate speeds may collect snapshots every 30 s while a vehicle traveling on a secondary arterial at a slower speed may collect data every 10 s. Snapshot generation can also be invoked if an event is noted in one of the vehicle systems. An event would be a change in state of

Potential Vehicle-based Elements

- | | |
|--------------------------------|---------------------------|
| •Hours of operation | •Impact sensor |
| •Elevation | •Barometric pressure |
| •Accelerometer data | •Fog lights |
| •Vehicle speed | •Headlights |
| •Heading/GPS Location | •Relative humidity |
| •Steering wheel rate of change | •Anti-lock braking system |
| •Exterior temperature | •Traction control |
| •Windshield wiper rate | •Stability control |
| •Rain sensor | •Pavement temperature |
| •Sun sensor | •Brake boost |
| •Adaptive cruise control radar | •Wiper status |

FIGURE 6 The list shows many different types of in-vehicle systems that could be polled during VII demonstrations.

a system, such as turning the vehicle traction control from off to on or from activation of a safety system such as the antilock braking system. Finally, snapshots can be generated when a vehicle begins moving and stays above a certain speed (e.g., 10 mph) or when it comes to a stop. A maximum of 30 snapshots can be stored in the vehicle before older or less priority data is overwritten.

Field Operational Tests

FHWA is working with a number of contractors to hold one or more field operational tests during 2008. Roadside units and communications have already been installed in test beds near Detroit, Michigan, and Palo Alto, California. A number of other communities have indicated interest in setting up similar capabilities.

Data Analysis

The initial emphasis during the field demonstration will be to capture data from vehicles during as many different types of weather and traffic conditions as possible. This includes daytime and nighttime data runs, along with attempting to capture liquid, freezing and frozen precipitation events.

It is envisioned that data analyses will include

- Comparison of vehicle-based data to in situ observations (ESS and nearby automated airport observations);
- Determination if there are biases, quality errors, or outliers within the vehicle data set; and
- Estimation of the minimum number of data samples that would be required that would result in a quality observation for a specific segment of road.

Once the vehicle-based data are assessed and considered to be of good quality, a second analysis utilizing other weather data sets will occur. For example, a correlation study will be performed to compare Doppler weather radar reflectivity data with vehicle wiper status and wiper rate. This study may show that vehicle-based data can be a tool to define better where radar echoes actually produce precipitation that reaches the ground.

A second study may entail correlating antilock braking system, vehicle traction control, or vehicle stability control activation events with slippery road surfaces (e.g., road surface friction) and with observed external air temperatures.

Roadway Segmentation and Data Aggregation

Once sufficient data are collected and analyzed for quality, an additional study may commence to determine how vehicle-based probe data can best be aggregated for use by the weather enterprise and the transportation community. Currently, thousands of airport-based weather observations are available across the country. However, within a decade of the introduction of VII-enabled vehicles and its supporting communications network, there could be millions of vehicle-based probe messages available each day. What is the best way to process this fire hose of data?

One possible solution could be to collect, process, and analyze vehicle-based data by road segments. A segment could be defined as a fixed length of Interstate from one mile marker to the next. Or if it is determined that fixed segmentation is not reasonable because of microclimates, terrain, or infrastructure differences, then the segments could be variable and correlated to the local features. For example, a segment may be better defined as along a span of a bridge or a road surface along the bottom of a canyon. Most important, each road segment could have its own set of localized metadata which would be able to describe its location and unique features.

Once segmentation issues have been considered, the next step will be to analyze how much data are required to generate a statistically sound (e.g., free of bias or outliers) observation. Should data be collected for 10 min for each segment and then processed for data quality? Are there a minimum number of data samples below which a statistically sound observation cannot be generated? If the numbers of data samples are low during nonpeak periods but much higher during peak periods, should observation timing be different? These are just some of the questions that will be explored during this phase of research.

SUMMARY

The RWM program of the FHWA has been working on several projects that will benefit both the surface transportation and the weather communities. The objectives of both projects include improving mobility, safety, and productivity on the nation's roadways.

This paper described two ongoing initiatives. The first is *Clarus*, which is a data management system for all public transportation agency surface transportation-related weather observations. The *Clarus* system has been designed and implemented and is currently being populated through the use of regional demonstrations and incentivizing programs. The latest documentation on the *Clarus* Initiative can be found on the program website, www.Clarusinitiative.org.

The second initiative described within this paper is VII. It has been shown that different systems on passenger vehicles can be used to observe directly or infer weather and pavement conditions. The VII Initiative aims to partner with automobile manufacturers to create an infrastructure that allows for two-way communications between the vehicle and the roadside. The long-term objective of the VII program is to create an enabling communication infrastructure to support both vehicle-to-vehicle and vehicle-to-infrastructure communications in support of both safety and mobility applications.

The Initiative has evolved to the point where test beds are being set up in several locations around the country. U.S. DOT plans on holding at least one field operational demonstration during 2008 to test communications and to study the quality of the data. Several studies are planned to determine how best to process the potentially large amounts of data for the benefit of the surface transportation community and the weather enterprise.

REFERENCES

1. NOAA/National Weather Service, U.S. Natural Hazards Statistics web page: www.nws.noaa.gov/om/hazstats.shtml. Accessed November 30, 2007.

2. Pisano, P. A., L. C. Goodwin, and M. A. Rossetti. *U.S. Highway Crashes in Adverse Road Weather Conditions*. Paper 8.1. 87th Annual Meeting of the American Meteorological Society, New Orleans, La., January 2008.
3. National Research Council. *Where the Weather Meets the Road: A Research Agenda for Improving Road Weather Services*. The National Academies Press, Washington, D.C. www.nap.edu/catalog/10893.html, 2004.
4. Petty, K. R., and W. P. Mahoney III. Enhancing Road Weather Information Through Vehicle Infrastructure Integration. In *Transportation Research Record: Journal of the Transportation Research Board*, No. 2015, Transportation Research Board of the National Academies, Washington, D.C., 2007, pp. 132–140.
5. Petty, K. R., and W. M. Mahoney III. *Weather Applications and Products Enabled Through Vehicle Infrastructure Integration (VII): Feasibility and Concept Development Study*. National Center for Atmospheric Research, Boulder, Colo., January 2007.
6. *Vehicle Infrastructure Integration (VII): VII Architecture and Functional Requirements Version 1.1*, USDOT, ITS Joint Program Office, Washington, D.C., July 20, 2005.

NATIONAL PERSPECTIVES AND ASSESSING TECHNOLOGIES

Winter Operations in View of Vision Zero**TORGEIR VAA***SINTEF Roads and Transport***ÅGE SIVERTSEN***Centre for Road and Traffic Technology in Trondheim**Norwegian Public Roads Administration*

The project Winter Operations is one of several actions and subprojects in the Norwegian national demonstration project for Vision Zero Traffic Safety Lillehammer. The background for giving priority to winter operations was the many serious winter accidents on National Road E6 in the Lillehammer area in the period 1995–2002. The purpose with the project has been to test possibilities for improvements in the winter operations by looking into the choice of strategy, operational methods, and level of effort and also systems for decision support. To improve the general terms for safer roads there was also reconstruction of E6 with different measures. E6 is a trunk road passing through the study area and most of the measures have been concentrated to this road. The winter operation part of the Vision Zero project has given important knowledge regarding local operation of the Vision Zero road network, but has also lightened up situations of national importance. The more general experience is especially valid for the importance of good mechanical cleaning of the roadway to reduce the salt consumption. The “theory” of using a winter road strategy when it is too cold to use salt has been confirmed to be an effective alternative to a bare road strategy.

The project Winter Operations is one of several actions and subprojects in the Norwegian national demonstration project for Vision Zero Traffic Safety Lillehammer. The background for giving priority to winter operations was the many serious winter accidents on E6 in the Lillehammer area in the period 1995–2002 (1).

OBJECTIVE

The objective of the project Winter Operations–TS Lillehammer is formulated like this:

The purpose with the project is to test possibilities for improvements in the winter operations by looking into the choice of strategy, operational methods, and level of effort and also systems for decision support. The project will illustrate the consequences with regards to effects on driving conditions and traffic safety. The effect of different measures will be assessed in relation to costs by a change in the winter operations. One important goal for the project is that the results in addition to having a local significance will lead to knowledge transfer and found a basis for assessment of measures and initiatives in the future from a Vision Zero point of view.

WHAT HAS HAPPENED IN THE PROJECT PERIOD?

The following measures have been carried out in the project period:

- New climate station established at Fåberg in autumn 2004.
- New winter strategy (almost bare roads) in autumn 2005.
- Reconstruction of E6 with different measures; visual central reserve partly with rumble strips, two-lane road with crash barriers on central reserve, narrow four-lane road. The reconstruction was completed in autumn 2005.
 - Testing alternative sanding methods.
 - Change in the contractor's operational routines autumn 2005 for adaptation to the physical changes on E6.

Figure 1 shows a road section with visual central reserve and rumble strips. Another example of physical measures is shown in Figure 2 with a picture of a road section with crash barriers on central reserve.

WINTER STRATEGY

New Strategy

The new salting strategy is summarized in Table 1. The main difference compared to the former salt policy was that the new requirements allow for anti-icing actions and that the temperature limit for salting in connection with snowfall was removed. There was however still a presumption that salting could only be carried out when snowfall was confirmed.



FIGURE 1 Visual central reserve with rumble strips.



FIGURE 2 Two-lane road with crash barriers on central reserve.

TABLE 1 Strategy for Almost Bare Roads

Measures	Measures and time to actions at different AADT		
	Under 3,000	3,001–5,000	5001 and above
Anti-icing	Carried into effect when friction can be expected to fall below 0.30		
Deicing after snowfall, bare in tracks within	6 h	4 h	2 h

The definition of the surface condition bare in tracks is that between the edge lines not less than 2/3 of the roadway should be free for snow and ice. For E6 the annual average daily traffic (AADT) is 10,000, i.e., the roadway should be bare in tracks within 2 h after the snowfall has ended. Compared to a full salting practice which requires bare road between the edges lines within the same time limits, this allows for a longer period to regain bare road condition after a snowfall.

RESULTS

Experiences with Changed Strategy

Viewed in relation to the salt consumption the strategy “almost bare roads” must be said to have been successful (see [Figure 3](#)).

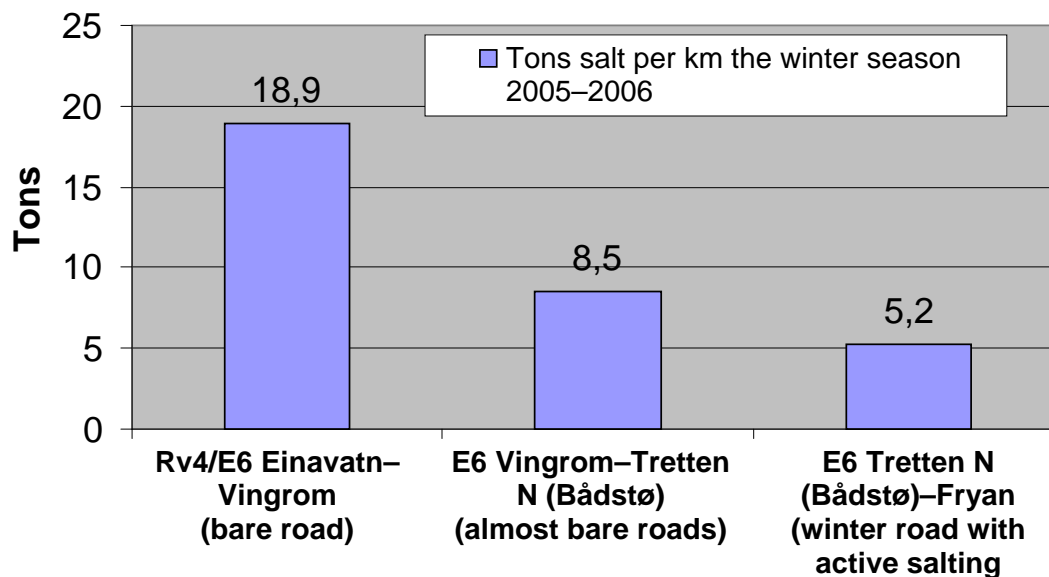

FIGURE 3 Salt consumption the winter season 2005–2006 on roads with different salting strategies.

In relation to previous practice with a kind of active salting, the increase in salt usage has been moderate. The difference in salt consumption between “almost bare road” and “bare road” is considerable when comparing E6 Vingrom–Tretten with almost bare roads standard and NR 4/E6 Einavatn–Vingrom with bare road standard. Following the intention with the reduced requirements in the “almost bare roads” strategy, this will imply that the requirements are linked to bare in tracks and not bare road between the edge lines, which follows from the bare roads strategy. The requirements for preventive salting actions are in practice the same, i.e., the salt is not spared in the beginning but at the end of the precipitation period. The discursive point here is how easy it is to gain real bare road in the wheel tracks, or whether the new strategy leads to an increase in the time with slippery road in tracks compared to a bare road strategy. The results from the winter season 2005–2006 indicate that this is the case.

A greater amount of the time with slippery road in tracks will imply increased risk for traffic accidents, but it is not possible on the basis of the experiences from only one winter season to conclude that there in fact is a higher risk with the almost bare roads strategy compared to the bare road strategy. Several of the physical measures carried out on E6 will probably also counteract the consequences of a greater proportion of the condition slippery in tracks.

Trials with the fixed sand method (mixing hot water and sand) have shown that this sanding method is an effective alternative when the temperature is too low to use salt (sodium chloride), i.e., when the road is operated according to a winter road strategy (2). Figure 4 shows an example with use of fixed sand on E6 on the four-lane road section. Results from friction measurements before and after spreading warm wetted sand are shown in Figure 5.



FIGURE 4 Fixed sand (warm wetted sand) spreading on E6, January 3, 2006.

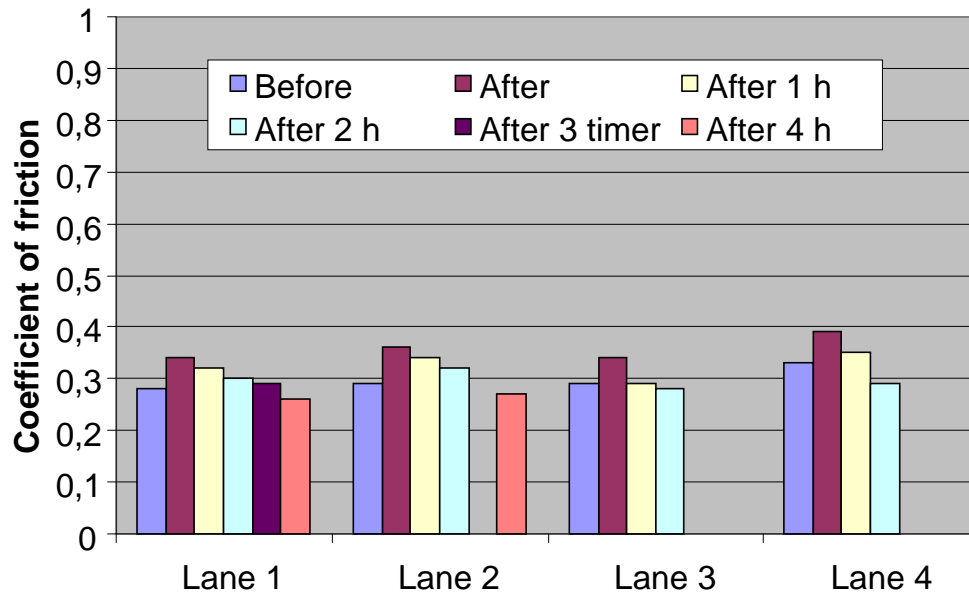

FIGURE 5 Results from friction measurements after fixed sand spreading on E6 road section with four lanes, January 3, 2006.

Even on a high traffic road such as E6, it seems that a fixed sand measure has so long duration that it is sufficient with 1–4 measures per day. To gain more experience with the fixed sand method on roads like E6 around Lillehammer, it would be desirable to study more periods with cold weather with fixed sand used as an ordinary measure.

The main impression is that during a snowfall it is difficult to keep the friction standard requirements on the four-lane road at Hunder on the lanes with least traffic, i.e., the lanes nearest the central reserve. It also seems to be difficult to maintain good driving conditions during greater snowfall in spite of relatively extensive salting.

In general the strewing actions seem to be carried out in accordance with the contract regulations, including in the cases when the road is operated using a winter road strategy. It would however have been of interest to follow up new precipitation cases to look more thoroughly into the extent of salting during snowfall with regards to both dosage and frequency of salting actions.

Decision Support and Follow-Up System

The contractor has access to several sources for road weather information as a support for their decisions, in terms of both prognosis and actual situation:

- Weather forecast (Meteogram) (prognosis),
- Weather radar (actual situation), and
- Climate stations, roadway weather information system (RWIS) (actual situation).

Figure 6 show an example of how the 3-day weather forecast looks like. The comparisons made between the weather forecast for Øyer and the RWIS station at Fåberg, show that there are some divergences (see Figure 7).

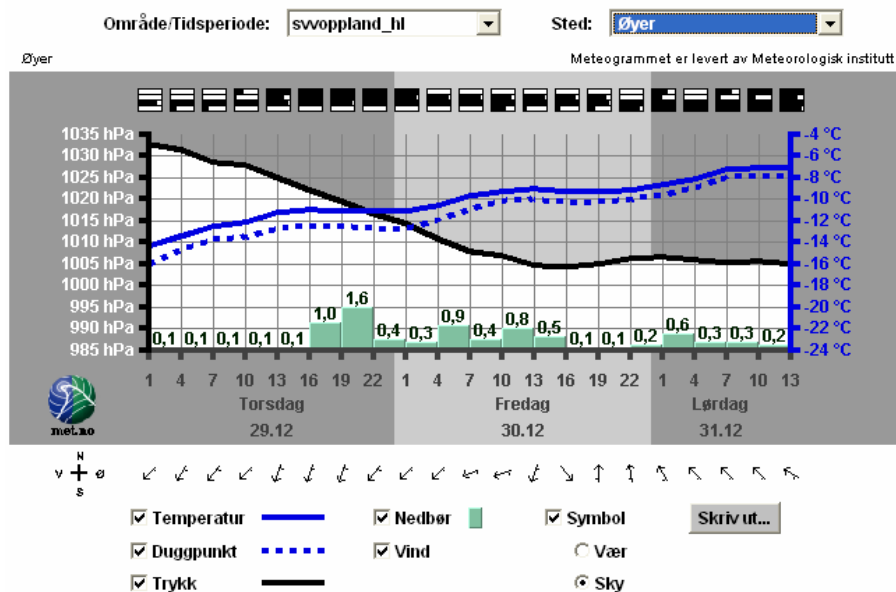

FIGURE 6 Three-day weather forecast.

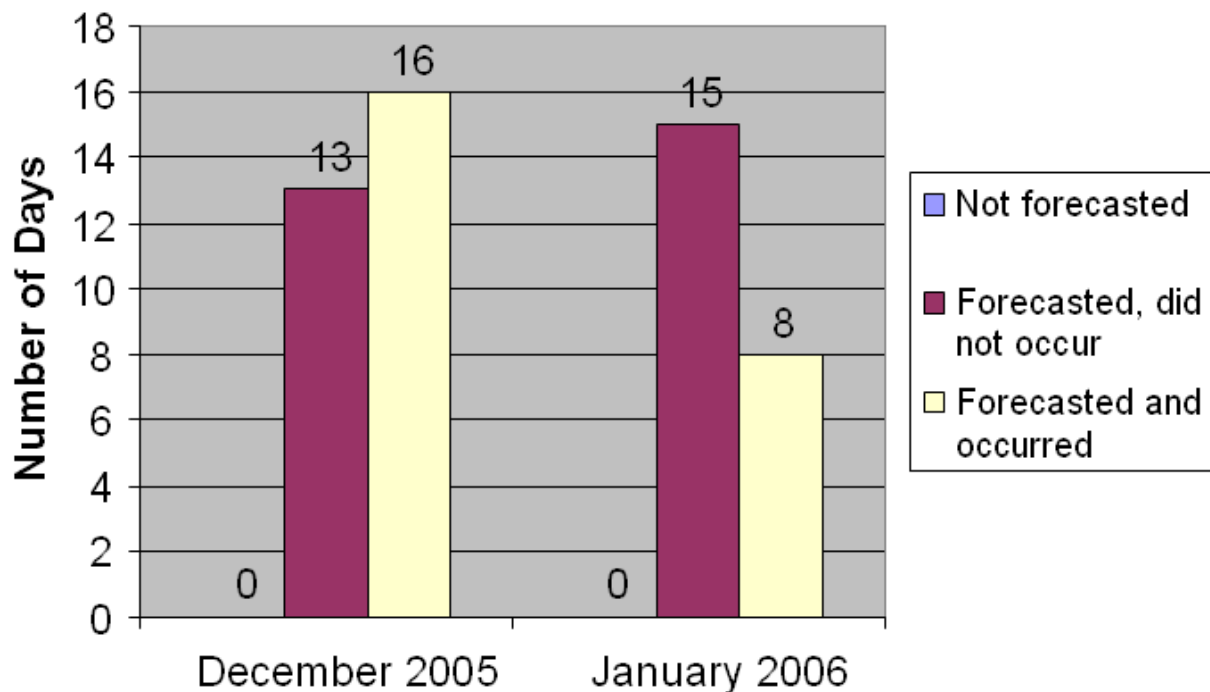

FIGURE 7 Number of days with precipitation in the Lillehammer area in December 2005 and January 2006.

For example, in December 2005 it was predicted there would be precipitation in 29 days, while precipitation was registered only in 16 days with a Tipping Bucket (precipitation measurement device). In January 2006 the weather forecast predicted 23 days of precipitation, while the actual number of days with precipitation was only 8 days with a Tipping Bucket. If one takes into account precipitation registered by Optic Eye (based on light beams) on days the Tipping Bucket did not detect precipitation, it was 9 days in December and 8 days in January with predicted precipitation, no precipitation was registered either by Tipping Bucket or by Optic Eye. All days with precipitation the weather forecast predicted rainfall or snowfall, i.e., there was no precipitation that was not predicted.

With the grid system the calculation models are based on and which is the basis for the generation of the weather forecast (Meteogram), one has to count on the fact that local conditions can diverge from the forecast. It is of course not sufficient to use only data from one RWIS station to assess the reliability of the weather forecast in general. As a central tool in the decision support system there seems however to be a need for a closer look at the quality of the weather forecast by analyzing other geographical areas.

Regarding the RWIS station at Fåberg, this is an advanced climate station that has a doubling of several of the functions, among them measuring the amount of precipitation (Optic Eye and Tipping Bucket). Optic Eye seems to be less accurate in quantity compared to Tipping Bucket, and in some cases there seems to be registered precipitation during dry spells. This can be a problem when considering whether there is a need for an action or not. With more frequent cleaning it is possible that the accuracy of Optic Eye can be improved.

Experiences with Operational Routines and Plowing and Spreading Equipment

In the winter season 2005–2006 the contractor used the tandem principle on the main road passing by Lillehammer. The following equipment was used on this specific road section:

- Truck with spreader in front-mounted plow and side-mounted plow (see Figure 8).
- Grader with front-mounted plow and plowshare (see Figure 9).



FIGURE 8 Truck with spreader in front-mounted plow and side-mounted plow.



FIGURE 9 Grader with front-mounted plow and plowshare.

On the road section between Tingberg and Vingrom there is a need for driving in tandem also for other reasons than because of the four-lane motorway on parts of the road section:

- Two-lane sections with central guardrail have evacuation passages. It is an advantage to plow these passages together with the roadway.
- Tandem driving makes it possible to plow ramps in crossings simultaneously with plowing of the main road.
- In broad crossing areas with painted canalization it is possible to plow the whole width in one operation by use of tandem.

In general driving in tandem is beneficial because the plowing action is finished earlier and a better standard on the road network and especially on ramps is achieved. One disadvantage for the contractor on a fixed price contract is that tandem driving leads to more kilometers of plowing.

Tandem is used during greater snow falls, the grader first and the truck behind. On two-lane sections normally only the front-mounted plow is being used on the grader. Normally the plowshare underneath the grader is used only when the snow is hard packed. The front-mounted plow on the truck places the snow to right edge and the side-mounted plow throws the snow over the snow bank or the guardrail. Thus most of the roadway on road sections with two lanes normally is plowed both with the front-mounted plow on the grader and the front-mounted plow on the truck.

In crossings the truck is plowing the ramps, and the grader the section between the ramps. The grader plows to the end of the on-ramp and then turns into the off-ramp. Afterwards the grader is backing on the on-ramp to achieve continuous plowing. Here the grader is waiting till the truck has finished the plowing of the ramps.

The share on the grader does not throw the snow like the side-mounted plow on the truck. No and then it is therefore necessary that the truck plows the section between the off-ramp and the on-ramp in crossing areas to get the snow thrown over the snow bank or the guardrail.

Both the plow and the plowshare beneath the grader are used on sections with 4-lane roadway. On the truck the front mounted plow places the snow out to the edge and the side mounted plow throws the snow over the snow bank and guardrail. When salting during the plowing action, the side mounted plow is used in full width to spread a sufficient amount of salt into the left lane.

The grader is driving with the front-mounted plow on the left side of the center line on ordinary two-lane roads. The area around the center line is thereby plowed twice. The truck coming behind the grader uses both the front-mounted and the side-mounted plow. The experience shows that the driving speed should not exceed 35 km/h to get a good result.

The same plowing principle is used on a two-lane road with central reserve with rumble strips as on an ordinary two-lane road. When plowing on the rumble strips the truck is shaking and produces more noise than on an even roadway. This is the reason why the speed should not exceed 35 km/h. More snow and slush are left in the rumble strip area than on the rest of the roadway. There are more spurts under slush conditions when the vehicle drives on the rumble strip area than on other parts of the roadway. There is very little wear on the profiled center line when it is combined with rumble strips.

In T-crossings with broad painted canalization there is a need for tandem driving in order to plow in the full width. Some extra wear is noted on the painted canalization in such areas.

The normal procedure is that salting takes place at the same time as the plowing action down to -8°C . The experience so far is that it is possible to avoid snow and ice packed layer on the roadway by using salt at such low temperatures. With the former strategy it was necessary to do some grading to get rid of the snow sole. One disadvantage by using salt at low temperatures is that the friction can become low and it can be a problem maintaining sufficient level of friction during and after the snow fall at such low temperatures. With regards to friction, snowfall at low temperatures is therefore a greater problem than snow around 0°C .

One disadvantage in using the grader is that the ground pressure on the front shaft is too low to balance the front plow. It is therefore important to adjust the height exactly during plowing. If the ground pressure on the plow becomes too heavy, there is a possibility that the driver can lose the steering of the grader.

On the other hand one advantage with the grader instead of the truck is that the grader is easier to maneuver. Furthermore it is easier to utilize the share on the grader to remove hard-packed snow and ice on short road sections and along the edge. Thereby the standard requirement is achieved faster and the action is finished earlier when one of the units in a tandem operation is a grader. The normal situation will however still be to use two trucks instead of one grader and one truck.

Accident Situation

Table 2 summarizes the accident statistics from 1995 and during the project period.

In the 3-year period 2003–2005 eight accidents with personal injury were reported on those parts of E6 included in the Vision Zero road section. In average this corresponds to 2.7 accidents per year. For comparison there were 8.2 accidents per year in the 8-year period 1995–2002.

From the accident pattern it seems that a combination of physical central reservation with crush barriers and reinforced winter maintenance has been the measure with the greatest influence on serious accidents. By introducing different measures at the same time it is however difficult to isolate the effects from a single measure.

CONCLUSIONS

The winter operation part of the Vision Zero project has given important knowledge regarding local operation of the Vision Zero road network, but has also lightened up situations of national importance. The more general experience is especially valid for the importance of good mechanical cleaning of the roadway to reduce the salt consumption. The “theory” of using a winter road strategy when it is too cold to use salt has been confirmed to be an effective alternative to a bare road strategy.

When it comes to an almost bare road strategy, this has been a successful strategy with regard to salt consumption. It is however uncertain what consequences reduced salting compared to a bare road strategy will have on traffic safety. From the increased proportion of a slippery road condition in tracks with the almost bare road strategy compared to a full bare road strategy, from known risk figures a certain increase in the number of traffic accidents.

The salting is by and large done in accordance with regulations in the contract, with preventive salting, salting during snowfall and then salting right after snowfall has stopped. However in some cases a too great an amount of salt has been used during the snowfall without

TABLE 2 Number of Accidents Before and During the Project Period

Type of Accident per Year	1995–2002	2003–2005
Accidents with personal injury	8.2	2.7
Accidents with serious personal injury	2.3	0.7 (before crash barriers were mounted)
Meeting accidents	1.4	0.7 (before crash barriers were mounted)

getting the expected results. It is therefore necessary to look more into the routines of salting during falling snow.

The four-lane road at Hunder is a challenge regarding keeping driving conditions as good as on the adjacent two-lane road sections. Further investigations should be conducted to see to what extent this is a local problem or a more general problem for four-lane roads.

When it comes to a winter road strategy and using sand for friction improvement, this will of course imply extra effort for the contractor to shift the method from salting to sanding. This can explain why fixed sand is used to so little extent, and it would have been desirable with a separate truck for each method. However, with good weather forecasts it should be possible to put up efficient operational routines based on using the same truck for both methods.

Methods for friction measurements have come into focus by the fact that different measuring devices on certain road conditions can give great deviations in measured coefficient of friction. It is also a question whether the standard requirement is reasonable with regards to what is realistic to achieve with friction improvement actions. In the almost bare road strategy it is possible that the time for reaching a certain road condition should be increased a bit to reduce the salt consumption during snowfall. The results from studies made in the project indicate that this not necessarily will lead to poorer driving conditions.

From the accident pattern it seems that a combination with physical central reservation with crush barriers and reinforced winter maintenance has been the measure with the greatest influence on serious accidents. By introducing different measures at the same time it is however difficult to isolate the effects from a single measure.

ACKNOWLEDGMENTS

The Public Roads Administration of the Road Directorate in Trondheim has been responsible for carrying out the project. In addition there was established a project group that functioned as a technical advisory group for the planning and conduct of the project. Both the local road administration and the contractor contributed actively in the project team.

REFERENCES

1. Giaver, T., T. Lindland, and T. Vaa. Winter Operations—TS Lillehammer. SINTEF Report A06089. December 2006.
2. Vaa, T. Implementation of New Sanding Method in Norway. *Transportation Research Circular E-C063: Proceedings of the Sixth International Symposium on Snow Removal and Ice Control Technology*, Transportation Research Board of the National Academies, Washington, D.C., 2004, pp. 473–486.

NATIONAL PERSPECTIVES AND ASSESSING TECHNOLOGIES

Proposed Test Bed for Surface Transportation Weather Technologies

MARK A. ASKELSON

LEON F. OSBORNE, JR.

University of North Dakota

One of the main challenges that face both travelers and department of transportation (DOT) personnel is surface transportation weather. Weather seriously impacts surface transportation, with rain, snow, blowing snow, etc., seriously impacting driver safety and mobility and DOT operations. Because of these impacts, numerous federal, state, academic, and private research thrusts are under way to mitigate them. These include the development of new sensor technologies to measure weather impacts on roadways better, the development of new algorithms to provide better guidance regarding surface transportation weather to improve traveler safety and mobility and to support DOT personnel decisions, and the consideration of human factors that dictate traveler utilization of information. The testing of new technologies has typically been performed at individual, focused sites. While this offers advantages such as significant control over experiments, serious disadvantages exist as well. As transportation systems have scales that are on the order of a state and even a region, there is a need to develop a regional test bed for surface transportation weather technologies. Such a regional test bed has been proposed across the region that encompasses North Dakota, South Dakota, Minnesota, and Wisconsin. This region has the advantages of (a) encompassing all varieties of weather hazards, (b) enabling the leveraging of existing sensor networks, (c) including both rural and metropolitan travel environments, and (d) enabling the leveraging of special facilities. This paper outlines the characteristics of such a network. Opportunities, challenges, needed partnerships, and potential steps forward will be discussed.

The purpose of this paper is to explore the possibility of expanding current capabilities for verifying and validating surface transportation weather technologies. These technologies include products for diagnosing and predicting surface transportation weather phenomena (e.g., snowfall accumulation along roadways, blowing snow in the roadway environment) and sensors developed and used to measure relevant parameters (e.g., snowfall, road condition).

To explore the possibility of expanding current capabilities for verifying and validating surface transportation weather technologies, this manuscript is organized in the following manner. First, to justify the need for doing so, impacts of weather on surface transportation are briefly reviewed (first section), mitigation strategies for ameliorating impacts of weather on surface transportation are discussed (second section), fundamental challenges in the field of surface transportation weather are considered (third section), future surface transportation research directions are explored (fourth section), and the importance of verification and validation is emphasized (fifth section). The proposed test bed is then discussed in the sixth section. It is noted that while fairly wide-ranging in scope, the field of surface transportation is very broad. The intent is not to cover all aspects of surface transportation weather but is, rather, to highlight some important aspects. The focus will primarily be upon travel along roadways.

WEATHER IMPACTS ON SURFACE TRANSPORTATION

The impacts of weather upon surface transportation are quite startling. Goodwin (1) estimated that approximately 22% of the 6,314,000 vehicle accidents that occurred on U.S. highways in 2001 occurred during adverse weather conditions, which were defined to be rain, sleet, snow, fog, rain and fog, and sleet and fog. In these crashes, approximately 6,918 people lost their lives. To put this into perspective, preliminary statistics for 2006 indicated that the total number of fatalities in the United States for commercial, general, and civil aviation was 1,532 (2).

Beyond loss of life, weather has a significant impact through injuries and transportation delays. While both of these have an associated economic toll, injuries also exert a personal toll on those affected. Goodwin (1) estimated that approximately 450,000 injuries were associated with crashes that occur in adverse weather conditions. This, combined with fatalities, underscores the personal toll associated with weather impacts on surface transportation.

The economic toll is also significant. Lombardo (3) estimated that in 1998 the economic toll associated with highway vehicle crashes was approximately \$42 billion. Considering that this involves only one transportation mode and thus is not including modes such as rail and marine, it is apparent that the economic toll of weather impacts on surface transportation is noteworthy.

This information has not been broken down according to travel environments (urban, rural, interstate versus secondary roads, etc.). Even so, it is important to note that these different environments do have different characteristics regarding crash likelihood, need for traffic management, and impacts of weather upon the transportation network. Moreover, weather phenomena beyond those listed above can impact surface transportation. Strong winds, for instance, can cause significant problems for high-profile vehicles that can lead to accidents; excessive heat can cause heaving of road surfaces (and rails) that can result in accidents.

MITIGATION STRATEGIES

Given the impacts of weather on surface transportation, numerous strategies have been employed to mitigate them. These strategies generally divide into two groups, traveler information and maintenance.

One effective way of mitigating some of the impacts of weather on surface transportation is by informing travelers of weather and road conditions that may impact their mobility. Numerous means are employed to do so. These include dynamic message signs, which are signs located in fixed locations that provide pertinent information to travelers including congestion, adverse weather (fog, rain, snow, etc.), and systems that are designed to deliver information into the vehicle. One such in-vehicle system is 511, which provides information regarding road conditions and weather to travelers through a cell phone service (4).

In addition to informing travelers of conditions so that they can adapt their travel strategies to enhance safety and mobility, another primary means by which weather information is being used to enhance surface transportation is through the utilization of such information to improve department of transportation (DOT) operations. An example of such uses includes planning construction operations. One of the primary ways in which this is currently accomplished, however, is the use of weather information to improve road maintenance. Specifically, weather information is used heavily in planning and performing wintertime

maintenance operations. Because of the need for such information and the need to provide this information in a way that enables maintenance officials to maximize the benefits of their decisions, maintenance decision support systems (MDSSs) have been developed (5, 6). By both utilizing information regarding weather conditions, roadway characteristics, and maintenance standards of practice and applying physical models of relevant processes, MDSSs have the potential not only to improve traveler safety by enhancing roadway maintenance (and, thus, alleviate some of the losses discussed above) but also to decrease maintenance expenditures by improving management of roadway maintenance resources (e.g., chemicals used to melt snow).

Another major effort in the mitigation of impacts of weather on surface transportation is the *Clarus* Initiative (7). *Clarus* is a developing weather data management system having as one of its main functions improved quality control of weather data observed with road weather information systems (RWISs) and with other weather observation systems. With improved data quality, one expects enhanced decision making and, thus, enhanced traveler safety and mobility.

FUNDAMENTAL CHALLENGES

The central challenge in surface transportation weather is determining what is happening and will happen to the road surface and the atmosphere directly above the road surface and how these will impact travelers. To accomplish this, several fundamental challenges must be faced.

The first challenge is data—specifically, data availability and accuracy. A broad survey of all of the challenges in obtaining relevant road weather data and road weather data elements would be much too large to fit within the scope of this discussion. Consequently, an example data element and corresponding observation platforms used to observe it are considered here to illustrate the problems that are faced. The data element is precipitation—specifically snow. The data-related challenges in utilizing available data to estimate snowfall occurrence and amounts along roadways are sparseness—representativeness and quality.

One of the primary information sources regarding precipitation gauges is surface observations. These are typically obtained from surface observation platforms like automated surface observing system—automated weather observing system (ASOS—AWOS). Unfortunately, the precipitation measurement instruments on these stations are highly inaccurate for snowfall because they were designed to handle rain well and have characteristics that result in poor performance in snow (8). While some ASOS—AWOS stations have manual intervention that enables human observers to provide snowfall observations, the number of these stations is very limited, as illustrated in [Figure 1](#). Consequently, the quality and resolution of this network for snowfall are very limited. Moreover, these problems apply to other surface networks such as RWISs. While visibility measurements can be used as a proxy for snowfall rate, the accuracy of such estimates is significantly limited, with >50% errors common (9).

Another heavily used source of information regarding snowfall is radar. This provides rapid updates of precipitation coverage and significant spatial resolution (data spacing on the order of 1 km at a range of 60 km from the radar). However, the accuracy of snowfall estimates obtained from radar data is also significantly limited, with 50% errors common (8). Moreover,

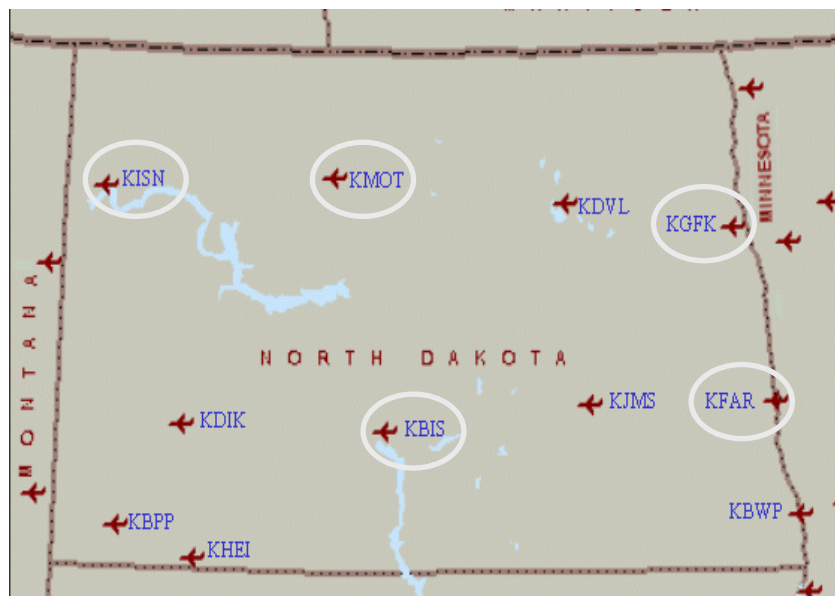

FIGURE 1 ASOS–AWOS stations in North Dakota.
The circled stations are manual intervention stations.

because of the curvature of the Earth, radar beams typically rise with distance from the radar, resulting in those beams constantly overshooting the tops of wintertime precipitation systems. An example of this problem is provided in Figure 2. Radar overshooting is apparent in this figure in the circular appearance of precipitation areas that are centered around radars. It is highly unlikely that a precipitation event is “smart enough” to snow in a nearly perfect circle. Radar overshooting is a significant issue since snowfall that could be causing significant travel problems is not observed at all. Moreover, radar overshoot is very common in the winter because of the relative shallow nature of wintertime precipitation systems relative to summertime precipitation systems. Consequently, according to radar data, some locations rarely, if at all, receive snow.

While the above example illustrated some of the data challenges associated with surface transportation weather, other major challenges exist. One of these is lack of knowledge regarding processes that are important to surface transportation weather. The challenge here in surface transportation weather is that weather phenomena on all scales, from thousands of kilometers (synoptic scale) to centimeters (microscale), are important. At this point and time, not all of the interactions at the microscale (and at other scales) are understood (10). There is a strong need for fundamental research to better understand these processes (e.g., terrain influences, vegetation influences, roadway energy balance, moisture balance) in a roadway environment (10). Such efforts would lead to increased understanding and, one would expect, to enhanced traveler information and roadway maintenance, which would then improve the mitigation of adverse weather impacts on surface transportation.

The final fundamental challenge discussed herein is human factors. Even if a surface transportation weather product conveys perfect information, a user may not utilize that information properly. For instance, a 511 system may indicate that roads are ice covered and

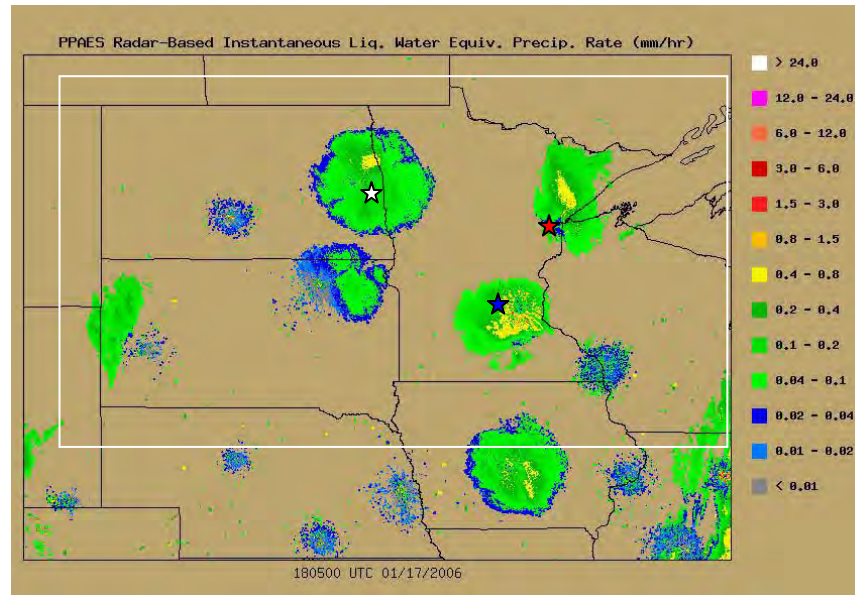

FIGURE 2 Liquid–water-equivalent precipitation rates at 1805 UTC (12:05 p.m. CST) on January 17, 2006, for a light snow event that affected a large portion of the northern plains. The white box illustrates the proposed test bed region. The white star indicates the approximate location of the Road Weather Field Research Facility; the red star indicates the approximate location of the Northland Advanced Transportation Systems Research Laboratories; the blue star indicates the approximate location of MNRoad.

slippery, and yet a traveler may travel too fast even with that knowledge and crash. Alternatively, information could be perfectly accurate but packaged poorly such that it does not catch the attention of the user and, thus, be totally ineffective at mitigating adverse effects of weather in surface transportation. As it is the actions of humans that must be affected or altered by the information being provided, these issues will always be central to surface transportation weather.

FUTURE DIRECTIONS

The field of surface transportation weather will constantly evolve, with scientists, policy makers, maintenance personnel, and travelers striving to enhance traveler safety and mobility. In this process, new technologies will be brought to bear on the many problems in surface transportation weather.

These technologies will include new instrumentation for measuring phenomena such as precipitation, blowing snow, fog, road state, and radiation–energy balance. Of these, one critical area that is likely to be attacked in the near future is precipitation, as the current observation network is inadequate for monitoring snowfall on roadways in real time, and wintertime precipitation has serious impacts on traveler safety and mobility through multiple processes, including direct deposition upon roadways and redistribution by wind. Regardless of the order of progression in the development of new instrumentation, determining the proper instrumentation given interminable budget constraints will always be a significant challenge.

In addition to instrumentation, new algorithms designed to provide improved information regarding surface transportation weather phenomena will also be developed. These include, but certainly are not limited to, precipitation, blowing snow, fog, road state, radiation–energy balance, and wind. In fact, researchers are currently working on several of these areas. Because of fiscal constraints, significant progress will require novel approaches that will likely oftentimes utilize multiple observation platforms to overcome weaknesses associated with individual observation platforms.

VERIFICATION AND VALIDATION

Verification and validation is one of the fundamental and most important tenets of the scientific method. It is the step that oftentimes separates the scientific method out from other methods that were found to be not nearly as effective. As such, though, it is fairly straightforward. One proposes something and then tests it repeatedly to ensure that the hypothesis holds up. The testing stage is where other approaches oftentimes failed.

As new technologies are developed, they must be tested within the surface transportation weather community to make sure that they perform well. This testing process is critical for all technologies, whether they involve new sensors or improved algorithms. While the creators of new technologies will undoubtedly provide information regarding performance, only the testing within the implementation environment (road weather environment) will provide the information needed to know that a new technology does or does not satisfy consumer needs.

THE COOPERATIVE ROAD WEATHER TEST BED (CORWET)

The concept for a cooperative road weather test (CORWET) bed came from (1) the need for adequate resources and environments for verification and validation efforts, (2) the fact that surface transportation systems have both local and regional characteristics, (3) the variety of weather phenomena that occur within the proposed area that are relevant to surface transportation weather, and (4) the existing resources that could be leveraged towards such a test bed. The proposed CORWET area is illustrated in [Figure 2](#).

One of the major advantages of the CORWET region is the variety of weather types that affect the area. They include common occurrences of snow, blowing snow, extreme cold, rain, sleet, freezing rain, convective storms, fog, heat, and strong winds. This wide variety of weather phenomena ensures that all varieties of weather that impact surface transportation could be studied within this region and could be studied with relative ease owing to the common occurrence of all of these weather elements within this region. While some regions can boast some of these elements, few can boast all of them. More southern locations, for instance, are much less likely to have common occurrences of snow and blowing snow, two phenomena that are of great importance in the surface transportation weather field. On the contrary, not only does this region experience significant snowfall, it also experiences significant blowing snow. North Dakota and South Dakota, in fact, commonly experience significant problems owing to blowing snow. A recent study completed by the Grand Forks National Weather Service Forecast Office shows that the area encompassing northeastern North Dakota and northwestern Minnesota is the blizzard

capital of the United States in terms of frequency of blizzard occurrence (Brad Bramer, unpublished data).

Another advantage of the CORWET region is the varied transportation environments that exist in the area. The two primary environments are urban and rural, with the Minneapolis–St. Paul area providing an excellent urban environment and the rest of the area providing a variety of rural environments. These include rural ranch and farm environments that are generally open (North Dakota, South Dakota, and parts of Minnesota) and wooded rural environments (parts of Minnesota and Wisconsin). Moreover, travel environments associated with moderate to small municipalities are common across the region.

Moreover, multiple transportation modes including private, trucking, transit, rail, and maritime (Great Lakes) are included within the CORWET region. Thus, while the emphasis has been on highway travel, other modes are very important within the CORWET region and could be studied.

Finally, the CORWET region encompasses special facilities that could be leveraged towards the needs of the test bed. These include the Surface Transportation Weather Research Center Road Weather Field Research Facility (RWFRF) (11), the Northland Advanced Transportation Systems Research Laboratories (NATSRL) (12), and MnROAD (13), for which the approximate locations are provided in Figure 2. The RWFRF is dedicated to testing both instrumentation and algorithms utilized in surface transportation weather. The mission of the NATSRL is to investigate issues related to winter precipitation systems for small urban areas. The MnROAD facility is a one-of-a-kind test road segment used to investigate impacts of traffic and freeze–thaw cycles on pavement materials and designs. Each of these facilities is special in its own right. Drawn together, they could be important elements in a regional surface transportation weather test bed that could provide the verification and validation infrastructure needed to solve both localized and regional transportation issues.

To become a reality, CORWET requires a partnership between stakeholders in state DOTs, FHWA, other federal agencies such as the National Oceanic and Atmospheric Administration, academia (e.g., the University of North Dakota, the University of Minnesota–Duluth, and any other interested universities), private industry, and any other interested parties. Furthermore, to enable such a partnership to function, CORWET would require a governing body (perhaps a steering committee) composed of members from all stakeholder groups that could make decisions regarding the test bed (like the allocation of resources, etc.). Finally, to be a success, CORWET would have to be utilized by members of the surface transportation weather community. Without this, CORWET would simply be an idea that never took flight.

ACKNOWLEDGMENTS

This work is supported under Federal Highway Administration Sponsored Research Program Funds through the North and South Dakota Departments of Transportation.

REFERENCES

1. Goodwin, L. C. *Analysis of Weather-Related Crashes on U. S. Highways*. Mitretek Systems, Washington, D.C., 2002. Available at www.ops.fhwa.dot.gov/Weather/best_practices/CrashAnalysis2001.pdf.

2. *Accidents, Fatalities, and Rates, 2006 Preliminary Statistics U.S. Aviation*. National Transportation Safety Board. Available at www.nts.gov/aviation/Table1.htm. Accessed November 29, 2007.
3. *Overview of U.S. Crashes & Weather Environment*. Office of the Federal Coordinator for Meteorology, Weather Information for Surface Transportation 2. Available at www.ofcm.gov/wist2/presentations/day2/5_panel4a/2_lombardo.ppt. Accessed November 29, 2007.
4. *511 America's Traveler Information Telephone Number*. Federal Highway Administration, U.S. Department of Transportation. Available at www.fhwa.dot.gov/trafficinfo/511.htm. Accessed November 29, 2007.
5. *Maintenance Decision Support System—Pooled Fund Study*. Meridian Environmental Technology, Inc. Available at <http://mdss.meridian-enviro.com/pfs/>. Accessed November 29, 2007.
6. *Maintenance Decision Support System (MDSS)*. National Center for Atmospheric Research. Available at www.rap.ucar.edu/projects/rdwx_mdss/. Accessed November 29, 2007.
7. *Clarus Initiative—A National Surface Transportation Weather Observing and Forecasting System*. Federal Highway Administration and Intelligent Transportation Systems Joint Program Office, U.S. Department of Transportation. Available at www.clarusinitiative.org/. Accessed November 29, 2007.
8. Super, A. B., and E. W. Holroyd III. *Snow Accumulation Algorithm for the WSR-88D Radar: Final Report*. Bureau of Reclamation Rep. R-98-06, 1998.
9. Rasmussen, R. M., J. Vivekanandan, J. Cole, B. Myers, and C. Masters. The Estimation of Snowfall Rate Using Visibility. *Journal of Applied Meteorology*, Vol. 38, 1999, pp. 1542–1563.
10. National Research Council. *Where the Weather Meets the Road: A Research Agenda for Improving Road Weather Services*. National Academies Press, Washington, D.C., 2004.
11. *Surface Transportation Weather Research Center*. University of North Dakota Regional Weather Information Center. Available at <http://stwrc.und.edu/fieldsite/live/index.php>. Accessed November 29, 2007.
12. *Northland Advanced Transportation Systems Research Laboratories*. University of Minnesota, Duluth. Available at www.d.umn.edu/natsrl/main.html. Accessed November 29, 2007.
13. *MnROAD*. Minnesota Department of Transportation. Available at www.mnroad.dot.state.mn.us/research/MnROAD_Project/MnRoadReports/description.asp. Accessed November 29, 2007.

Modeling and Forecasting Temperatures in Surface Transportation

MODELING AND FORECASTING TEMPERATURE IN SURFACE TRANSPORTATION

Modeling Rail Temperature with Real-Time Weather Data

YU-JIANG ZHANG
ENSCO, Inc.

SUNG LEE
Federal Railroad Administration

Railroad safety is a top concern for the railroad industry. Preventing track buckling is important to infrastructure integrity and operation safety. To prevent heat-related track buckling, many railroads commonly impose slow orders during hot weather which is perceived to increase risks of track buckling. The deficiency of this practice is that trains are often slowed unnecessarily, while in some circumstances, when buckling risk is high, trains may not be slowed. The difficulty in arriving at an optimum decision for slow orders lies in the quantification of track-buckling risk. Track buckling is influenced by numerous factors, among which rail temperature is a critical factor. Unfortunately, rail temperatures are not easily obtainable. Decisions for slow orders are often based on an arbitrary ambient temperature limit. The limit is set on the basis of a simple assumption that the rail temperature will be 30°F to 35°F above the ambient temperature. This assumption is widely adopted even though rail temperature is not linearly related to the ambient temperature. It is therefore important to quantify rail temperatures accurately for reference in the slow order decision-making process and more importantly for assessing derailment risks that ambient temperature may hinder. This paper presents a model for predicting rail temperatures based on real-time meteorological forecast data. The model was developed by modeling the heat transfer process of the rail exposed to the sun. In the development of such a model, an experimental station was instrumented, composed of a portable weather station and a short segment of rail track with temperature sensors installed on rails. The model has proven to be able to predict the maximum rail temperature within a few degrees and within 30 min of the actual time when the maximum rail temperature occurs during the day. The model has been validated for three locations where real-time weather data and rail temperature were collected.

Track buckling-related derailments are very costly to the railroad industry. According to the FRA's train accident database, there were 3,855 track geometry related train accidents from January 1, 1997, to July 31, 2007, causing more than \$359 million reportable damages and 269 personal injuries. Of the 3,855 train accidents, 339 or 8.8% were track buckling-related, yet they account for 29% of total reportable damages and 54% total personal injuries (1). To prevent track-buckling derailments, railroads have adopted precautionary procedures that involve issuance of slow orders when daily ambient temperatures reach a certain level. Some railroads issue slow orders on the basis of forecast ambient temperature. Some others send out track inspection personnel to measure rail temperatures before issuing slow orders. This practice is to a certain degree effective in reducing track buckling-related derailments and associated costs. However, excessive slow orders and subjective inspections (which in many cases are unnecessary) cost the railroad industry many millions of dollars each year. Excessive slow orders may create congestion and bottlenecks, possibly impacting the nation's economic well being.

But in some cases where buckling risk could be high, slow orders are not issued since ambient temperature is low.

The optimal method of issuing slow orders would probably be based on accurate instantaneous rail temperature and rail neutral temperature (RNT) or the stress-free rail temperature. Both temperatures have been dealt with extensively by researchers and the railroad industry. Unfortunately, neither of the two temperatures is easily obtainable. Accurately measuring rail temperatures is limited by numerous factors, including resources, time of the day, rail orientation, location of the measuring points, and measuring device. Measuring RNT proves to be even more difficult. Complicating the issue further is that original RNT, which is set when rails are installed, changes continuously because of operational and environmental factors. These are reasons why slow order decisions are often based on an arbitrary ambient temperature limit. The rationale for using an ambient temperature limit is based on the presumption that rail temperature can be 30°F to 35°F above ambient and the RNT can be 25°F to 30°F below its original value. A difference of 60°F between rail temperature and RNT is believed to generate enough longitudinal stress to cause a moderate track to buckle (2).

This paper presents a rail temperature prediction model to improve the slow order decision-making process by providing reasonable rail temperature predictions. The objective is to predict rail temperatures based on real-time meteorological forecast data obtainable from commercial weather service providers.

FACTORS AFFECTING RAIL TEMPERATURE AND TRACK BUCKLING

It is well understood that track buckling is caused by a combination of factors. Figure 1 summarizes the factors and processes that influence track buckling. The presence of rail longitudinal stress is essential for track buckling to occur. Track panel shift resistance becomes insufficient when rail longitudinal stress is high and results in a high lateral buckling force once the track starts to buckle. External excitations are needed in most cases unless the stress level is extremely high and other factors set favorable conditions for buckling.

Of all these factors, rail temperature, perhaps, can be regarded as the single most important factor. The railroad industry has committed significant resources to monitor rail temperatures with mixed results as rail temperature is influenced by many factors. There have also been efforts to correlate ambient temperature with rail temperature. A linear regression technique is commonly used in quantifying the relationship between ambient and rail temperature. The correlation often focuses on the maximum daily ambient and measured rail temperatures for a specific period of time.

As illustrated in [Figure 1](#), rail temperature is a function of various weather conditions and rail parameters. Ambient temperature is only one of many weather parameters that cause rail temperature to change. Obviously, a linear relationship cannot quantify rail temperature on the basis of ambient temperature. Such a relationship would overestimate rail temperatures on cloudy and windy days and underestimate rail temperatures on clear and less windy days.

Nevertheless, the previous studies have contributed to an understanding of rail temperature ranges and track conditions under which track buckling is likely to occur. Computer programs were also developed to quantify buckling risks based on established critical rail temperatures for different track conditions, above which the probability of track buckling increases exponentially. It is widely accepted that in the worst case scenario rail temperature can

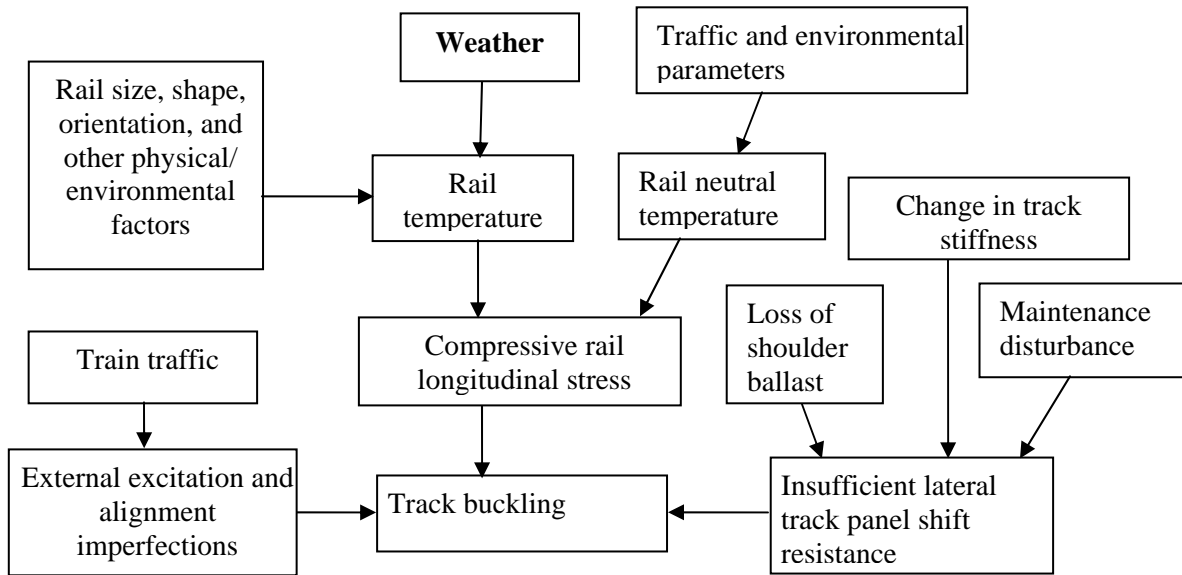

FIGURE 1 Factors influencing track buckling.

exceed 30°F above the ambient temperature. On a 95°F day the rail temperature can presumably reach 125°F. This temperature is considered dangerous for track locations where RNT may have dropped to 65°F or lower. On the basis of this common assumption, railroads issue slow orders or conduct rail temperature measurements when forecast ambient temperature will reach a preset limit and rail temperature will presumably exceed critical rail temperatures.

The study presented in this paper will prove that the worst case scenario is overly conservative in many cases and can still miss potential risks in some others. The model presented here will provide quantitative indication on how high the rail temperature really should be for a specific set of weather conditions for any given hour of the day. It is advantageous to use rail temperature for slow order decision making. For this purpose, more weather parameters than ambient temperature will have to be incorporated into the rail temperature prediction model. These parameters are discussed in detail in the following section.

MODEL APPROACH

The technical approach chosen in this study is to quantify the heating process of a rail exposed in the open sun. The model makes use of real-time weather data produced by existing comprehensive numerical weather models to project rail temperatures. As an operational decision-making assistance tool, the model is intended for up to 9 h of rail temperature forecasts. A longer period of forecasts is also possible, but the level of confidence would diminish along with the weather forecasts. Unlike a road network that is more concentrated in metropolitan centers where support infrastructure has been well established, much of a rail network is scattered over deserted and mountainous areas. In situ measurements of rail temperature are often difficult. The model is designed for use with or without a network of rail temperature

sensors mounted on rails. Where these sensors are available, the measured rail temperatures along with local weather data can be used to calibrate and improve the rail temperature prediction model. In the absence of these sensors, the model will take the ambient air temperature as the initial rail temperature for prediction of rail temperatures. The system frequently updates predicted rail temperatures based on the current rail temperature, as well as updated weather forecast data from the time of analysis until the end of the prediction period.

The rail temperature forecast model is depicted in Figure 2. The rail temperature is derived by modeling transient heat transfer of a floating body representing a finite rail element. In reality, the rails are not completely afloat in the air but are supported by interspersed ties and plates and continuous crushed rock ballast. The energy equilibrium for the rail element is in the following form:

$$\dot{E}_{in} - (\dot{E}_{conv} + \dot{E}_{rad}) = \dot{E}_{st} \quad (i)$$

where

\dot{E}_{in} = rate of energy absorbed by the rail from the sun and atmospheric irradiation,
 \dot{E}_{conv} = rate of energy emitted from the rail through convection,
 \dot{E}_{rad} = rate of energy emitted from the rail through radiation, and
 \dot{E}_{st} = rate of energy change.

Equation (i) is a first-order, nonlinear, nonhomogeneous, ordinary differential equation. The energy balance is affected by weather conditions, rail metallurgical properties, rail size and shape factors, and environmental parameters. The remaining energy components are influenced by the factors listed below.

Energy inputs due to solar and atmospheric irradiation are

1. Cloud coverage of the sky,
2. Season—Earth's position relative to the sun,
3. Solar angle—function of time of the day and the seasons,
4. Relative humidity and dew point temperature, and
5. Rail size and shape factors.

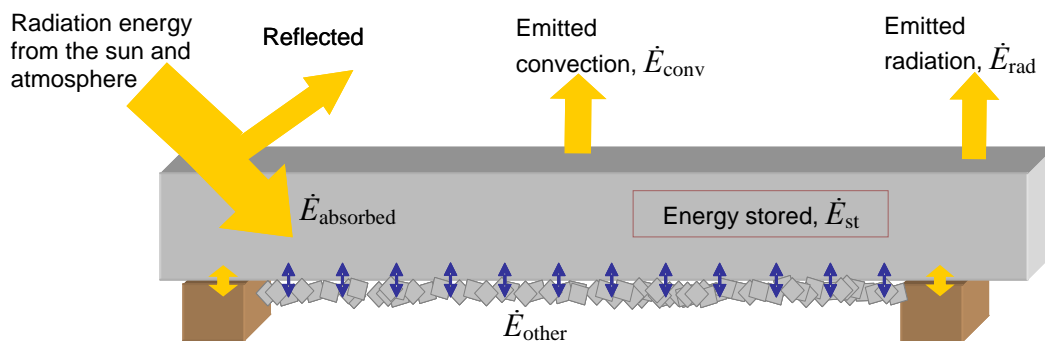

FIGURE 2 Transient heat transfer of a rail element.

6. Rail orientation, and
7. Rail surface albedo (the measure of reflectivity of rail surface).

Energy emitted by the rail due to convection and radiation influences

1. Ambient temperature,
2. Relative humidity,
3. Dew point temperature,
4. Wind speed and direction,
5. Sky condition (cloud coverage),
6. Rail size and shape factors,
7. Rail surface area subject to convection heat transfer,
8. Rail orientation,
9. Rail surface emissivity, and
10. Instantaneous rail temperature.

As shown in [Figure 2](#), there is also some energy exchange at the bottom of the rail, mainly through conduction. Since the heat conductivity of wooden ties and rock ballast particles is far lower than that of steel, any energy exchange is ignored; this means the materials below the rail are treated as an insulation layer. The net energy gain or loss in the rail will cause the rail temperature to rise or fall. The rate of the temperature change depends on heat conductivity and the heat capacity of rail.

For model algorithm verification and development, a local rail–weather station was established as illustrated in [Figure 3](#). The station consists of a mobile weather station with an integrated sensor suite, rail temperature sensors, two short segments of rails that are installed on three wooden ties, and crushed rock ballast filling between the ties and under the rails. The temperature sensors are installed in the web of the rails, collecting rail temperature at regular intervals. The portable weather station next to the rail track collects comprehensive weather data at the same intervals.

The collected data are transmitted wirelessly to a data console with an embedded data logger. The data console uploads the data to a development computer hourly for model development and analysis.

PRELIMINARY RESULTS

To demonstrate the model, the first step is to examine whether the rail temperature exhibits the relationship that the modeling theory would expect. [Figure 4](#) shows measured weather and rail temperature data for a 5-day period between January 1, 2006, and January 15, 2006. It illustrates various weather conditions and corresponding rail temperatures. Weather conditions included the following scenarios:

- Clear day with little wind (January 12, 2006). Rail temperature reached 86°F (30°C), or 26.5°F (14.7°C) above the ambient temperature.
- Clear day with strong wind (January 15, 2006). Rail temperature was 57.9°F (14.4°C), or 17.8°F (9.9°C) above the ambient temperature.

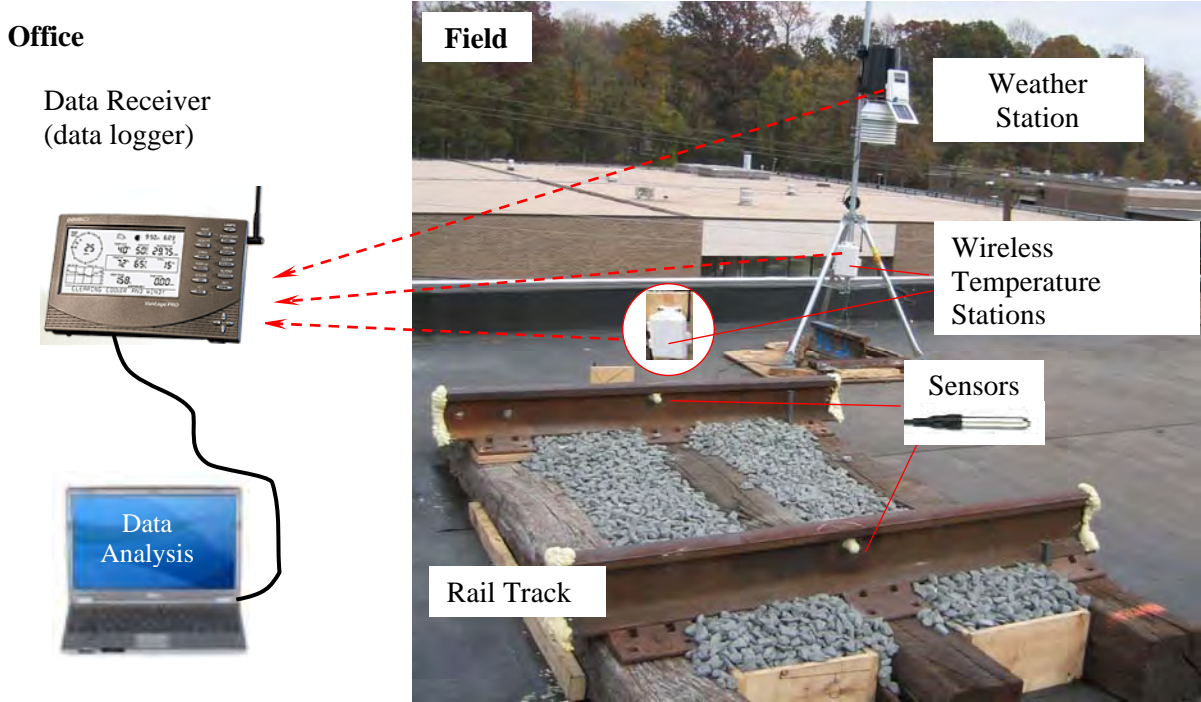

FIGURE 3 Rail-weather station.

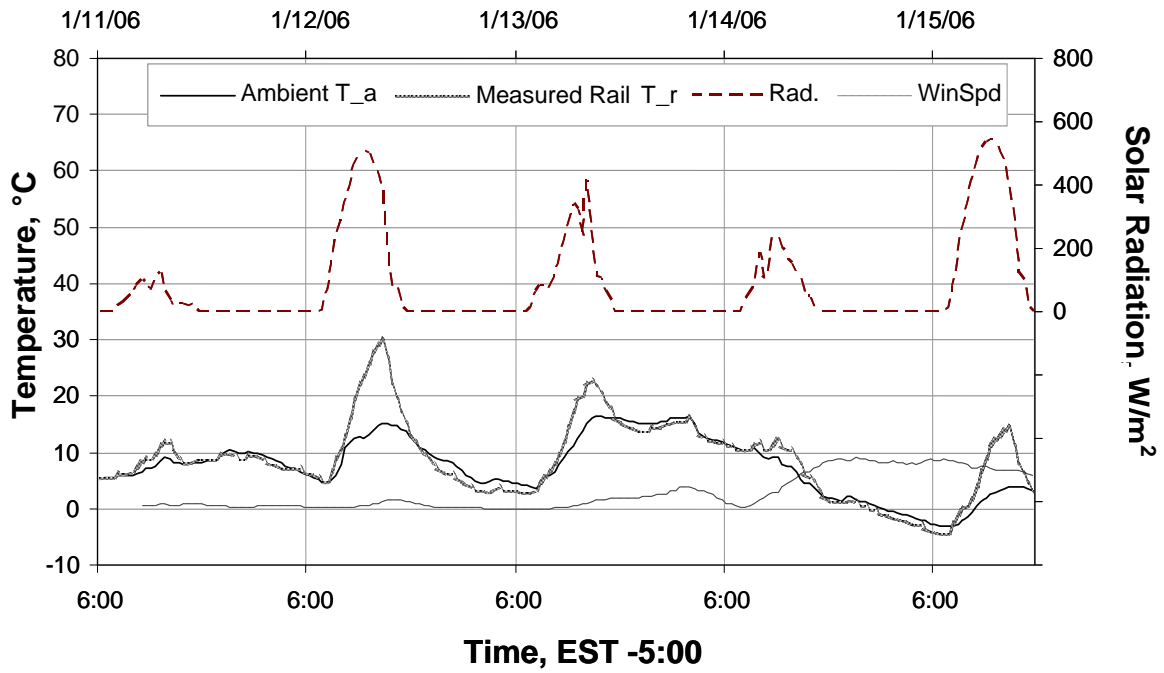

FIGURE 4 Measured rail temperatures and meteorological data.

- Cloudy day with little wind (January 13, 2006). Rail temperature was slightly above ambient temperature.
- Cloudy day with moderate wind (January 14, 2006). Rail temperature was only slight above ambient temperature.
- Generally overcast with little wind (January 11, 2006). Rail temperature was about the same as the ambient temperature.

With the weather data and track parameters, the model was able to predict rail temperatures with reasonable accuracy. Figure 5 shows the predicted rail temperatures compared with measured values for the above mentioned 5-day period. The results proved that the model algorithm was appropriate for predicting rail temperatures based on weather data. Although the predictions appear to be reasonable, there are situations that the model may not have accounted for accurately. These include the effect of wind and heat radiation from the rail to the sky. Currently, the model employs a simple method to account for the effect of wind cooling and linearly extrapolates the sky temperature, a parameter used in calculating heat radiation from the rail to the sky. The results indicate that the model may have underestimated rail temperatures for some weather conditions, e.g., January 11, 2006. The model seems to behave well for sunny days, e.g., January 12, 2006, and January 15, 2006.

Some of the parameters involved in the model may vary with seasons and geographical locations of different latitudes. The model was also verified for hot summer days. Figure 6 shows the model results for Springfield, Virginia, for the week July 26–31, 2006. The model predicted the maximum rail temperatures within 2°C (3.6°F), except for July 26, 2006, for which the model overestimated the maximum rail temperature by approximately 4°C (6.8°F). A few quick passing clouds during the hottest moments of the day prevented the rail temperature from going up as predicted.

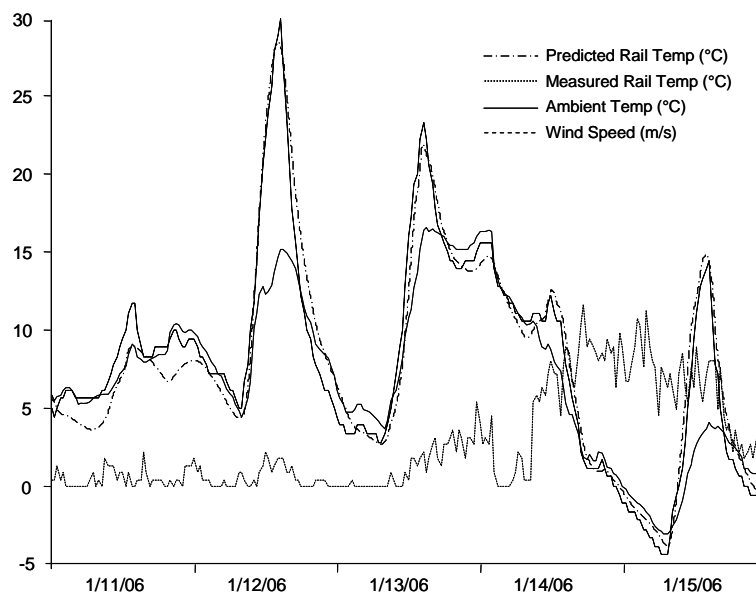

FIGURE 5 Predicted rail temperatures versus measured data, January 2006.

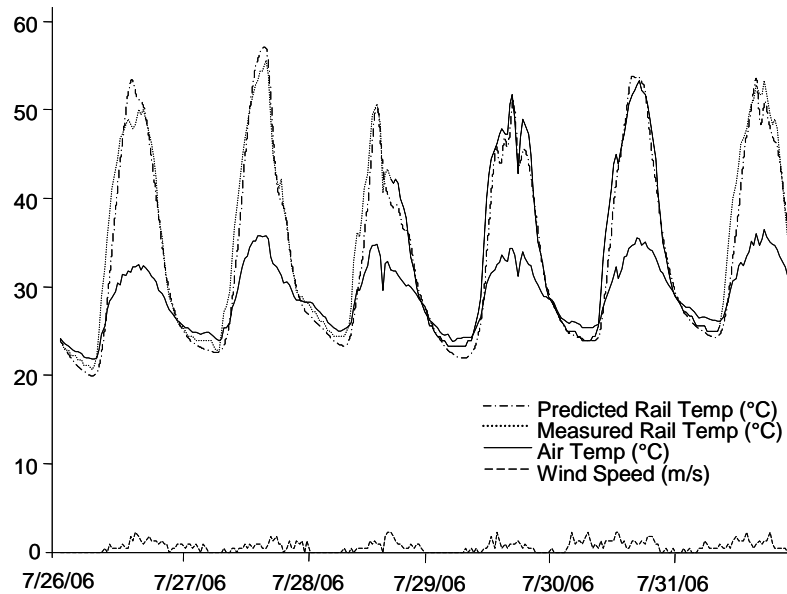

FIGURE 6 Predicted rail temperatures versus measured data, July 2006.

Of the 6 days included in Figure 6, July 31, 2006, had the highest ambient temperature (98.2°F). The highest rail temperature, however, was recorded on July 27, 2006, which reached 132.1°F, which was 34.7°F above the maximum ambient temperature. This underlines the fact that the maximum ambient temperature alone does not dominate the rail heating process.

Available weather and rail temperature data collected since late 2005 have shown that on certain days the ambient temperature could linger at the proximity of maximum temperature for a few hours, while on some other days, the ambient temperature could drop quickly after reaching its peak. These two scenarios will result in different rail temperatures. Of course, other factors such as wind and solar radiation also play important roles in affecting rail temperatures.

It is worth pointing out that on January 28, 2006, a relatively mild winter day, the rail temperature reached 93°F, nearly 30°F above the ambient temperature. This should sound the alarm if the rail had been restressed for the winter season to reduce tensile stress and hence lowered the RNT with a rail plug.

Figure 7 shows the scattered plot of the predicted daily maximum rail temperatures against the measured data for February 1 to May 31, 2007. It shows that predicted rail temperatures agree reasonably well with measured values. These rail temperature predictions were in 30-min intervals and were based on observed weather data and known track conditions.

The high correlation between predicted and measured rail temperature indicates that the model accurately predicted the peak rail temperatures for most days. However, the model overestimated or underestimated the peak rail temperature for some days. One of the reasons is that the model currently assumes a constant difference between ambient temperature and sky temperature in calculating energy radiated from the rail to the sky. In reality, the sky temperature can be 60°C below ambient temperature for clear sky or close to ambient temperature for overcast and rainy weather. The difference between the ambient and sky temperatures also varies with latitudes and seasons when the Earth's axis tilts at different angles toward the sun.

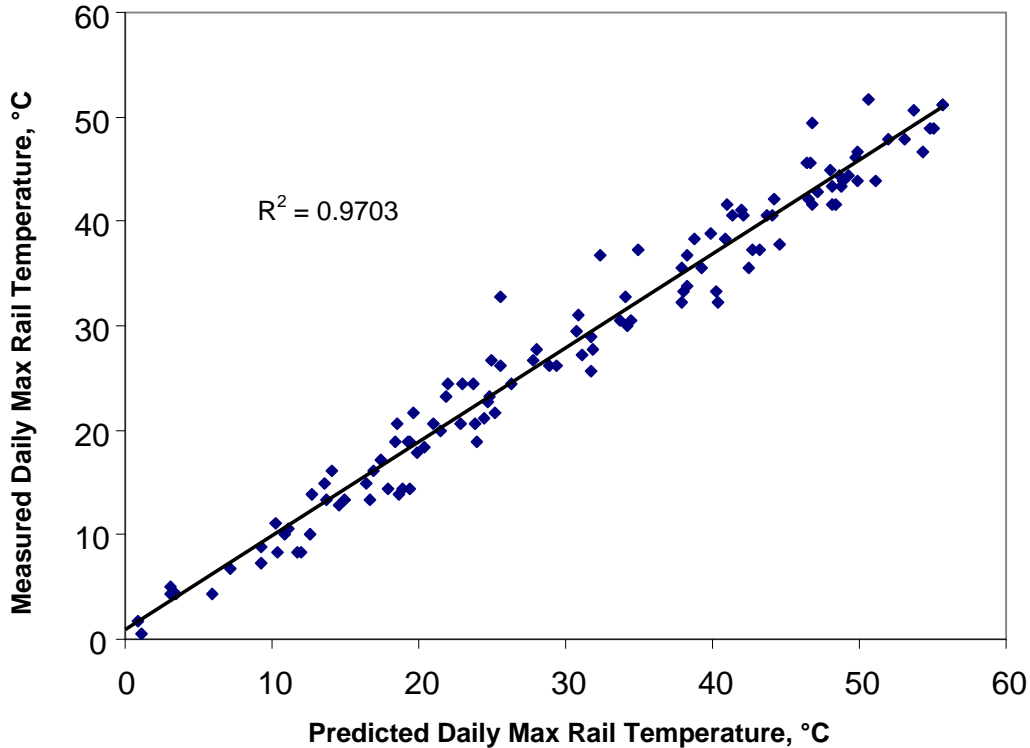

FIGURE 7 Predicted and measured daily maximum rail temperatures, February 1, 2007, to May 31, 2007.

An extensive literature search failed to identify models or procedures to quantify the sky temperature under different sky and weather conditions.

Other major factors affecting model accuracy include weather data updating intervals, wind speed and direction, and rail surface emissivity. Better assessment of these parameters should improve the model accuracy.

MODEL PERFORMANCE VERSUS DATA QUALITY

For practical applications, the model uses weather forecast data for prediction of future rail temperature. Currently, the model receives real time weather forecast data in 30-min intervals. The weather data are for weather grids of the size 9 x 9 km, covering 10 U.S. states in the Northeast. The real-time weather data are transmitted into a files server. A data processor loads the processed weather data into a database. A web-based application provides interfaces for users to view the rail-weather map and query the application to produce reports.

In addition to the rail-weather station used for model development, two additional stations were established on Amtrak for model validation. Each station consists of a local weather station and rail temperature sensors. The rail-weather application predicts rail temperatures for the next 9 h for the above weather grids. The measured weather data and rail

temperature data from these stations are used to verify the accuracy of model predictions and for model improvements.

To evaluate the model's performance further, both forecast weather data and locally observed weather data for Springfield, Virginia, were used to predict rail temperatures. Figure 8 shows the results for December 15 to 31, 2006. The solid line labeled "predicted Rail T_m" is the rail temperature prediction using observed weather parameters. The dotted line labeled "predicted Rail T_f" shows the rail temperature prediction using forecast weather data.

There was several degrees difference between the two sets of predictions for most days. For some days the rail temperature predictions using forecast weather data are higher than those using observed weather data. On some other days, though, rail temperature predictions using forecast weather data are lower. The inconsistency of the trend reflects the effects on rail temperatures of multiple weather parameters. To clarify the discrepancies, a comparison was made between the forecast and measured weather parameters. Figure 9 shows the comparison of two major weather parameters involved in the model. The upper portion of the figure shows the observed and forecast solar radiation energy. The lower portion of the figure shows measured and forecast ambient temperatures in Celsius. The forecast data are very close to the observed data for December 23, 2006. The predicted rail temperatures using the two sets of data are also very close as shown in Figure 8. On December 17, 2006, and December 30, 2006, the forecast weather data were also close to that observed at the local station. The predicted rail temperatures, however, differed by several degrees. These differences are due to other weather parameters, one of which is wind speed, not shown in Figure 9. Modeling the effect of wind is particularly challenging. The forecast wind speed differs significantly from the locally observed values. The wind speed and direction at the point where the anemometer is installed can vary significantly

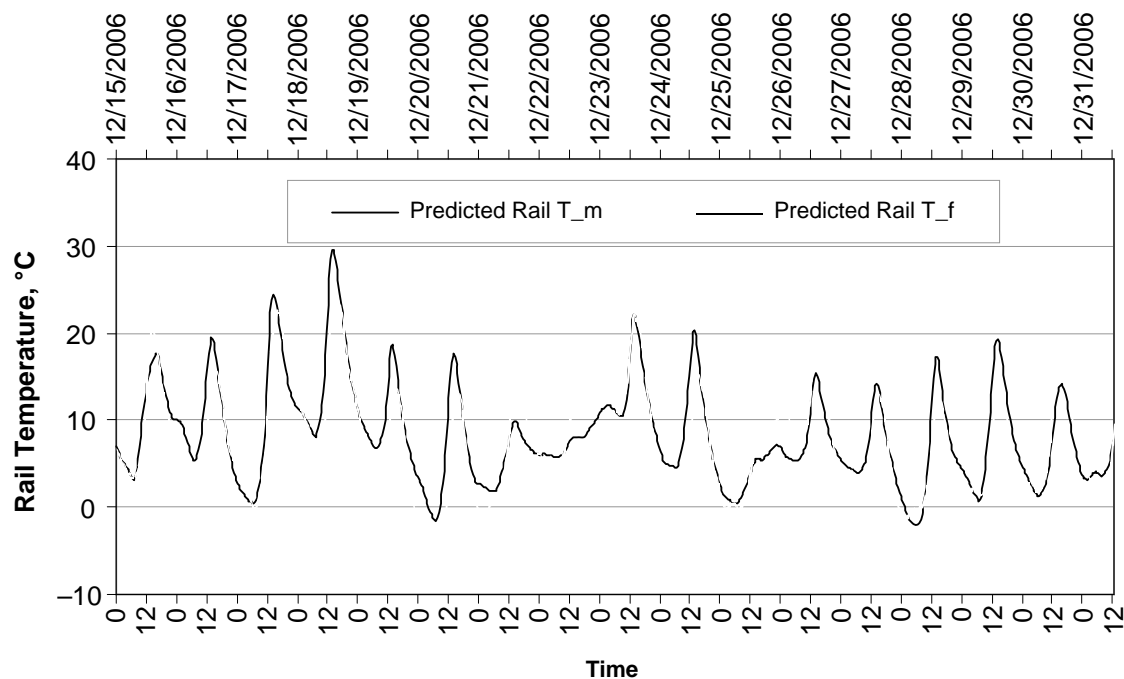

FIGURE 8 Predicted rail temperatures using forecast and observed weather data for Springfield, Virginia.

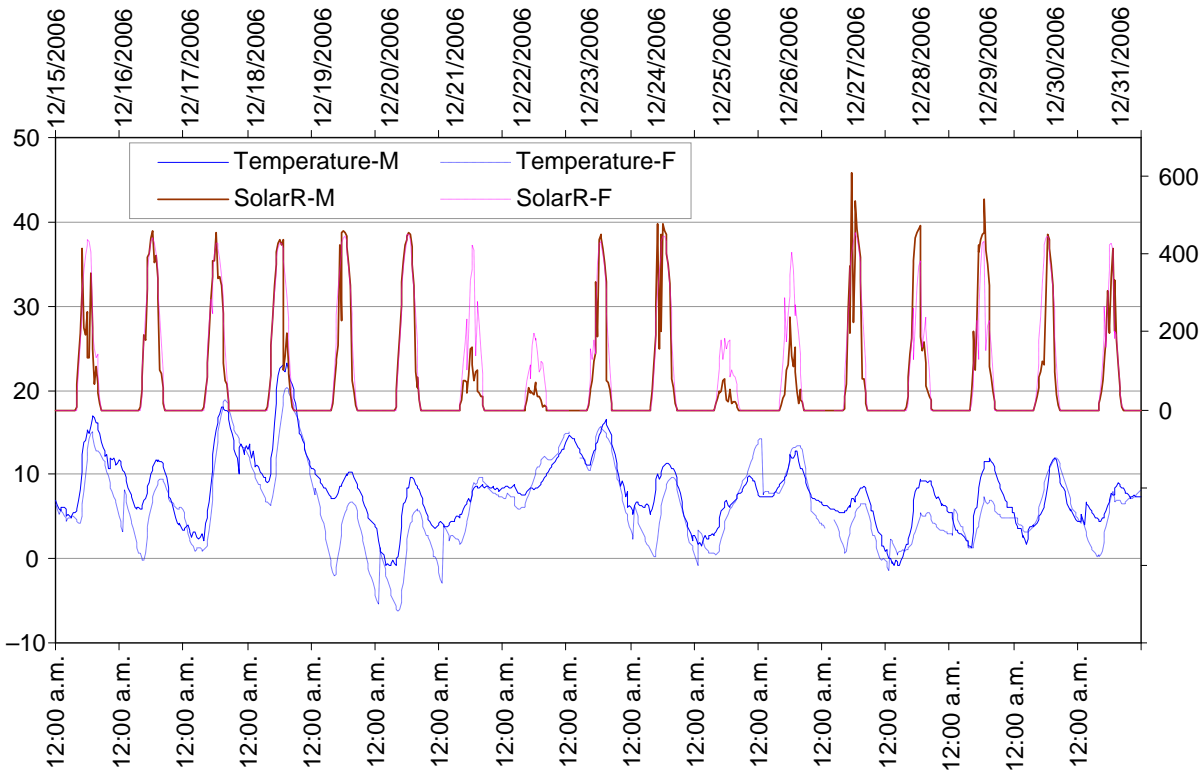

FIGURE 9 Comparison of forecast with observed weather data for Springfield, Virginia.

from that at the track level. In addition, none of the three validation stations is clear of surrounding obstacles, such as trees, bushes, and buildings. This means that the wind in some cases may not cool down the rail as the model has assumed.

The differences between locally observed weather parameters and forecast weather parameters highlight the need to have more frequent weather forecast updates to reduce the uncertainties in rail temperature predictions. This requirement for short forecast intervals and high-resolution weather forecasts has posed challenges for longer-term forecasts. The current 9-h forecasts are the best available because of limitations of the scope of the research project. A longer period of weather forecasts would translate into lower accuracy and resolution in rail temperature predictions.

CONCLUSIONS

The current industry practice of relying on forecast ambient temperatures for slow orders is inadequate because ambient temperatures are not linearly related to rail temperatures. Previous efforts in modeling rail temperature using the linear regression approach would lead to predicted rail temperatures far off the actual values.

A prediction model has been developed as the core component of a system for predicting rail temperatures, offering more accurate prediction of rail temperatures. The model is based on a transient heater transfer phenomenon of a rail in the open sun. The algorithm was verified and

calibrated by using locally measured weather and rail temperature data. The preliminary results indicated that the model was able to predict rail temperature within a few degrees of accuracy in most cases, providing the weather data are accurate.

The rail temperature prediction model will inevitably inherit the uncertainties from weather forecasts. Short weather forecast intervals are deemed important for accurate rail temperature predictions. Further validation and improvement of the model continued at the time the paper was written. Better assessment of key weather parameters should result in more accurate rail temperature predictions. Other factors, such as rail orientation, rail surface conditions and shape factor, and temperature gradient within rail cross section, are also of interest to this research, although the current research points to minor effects on rail temperatures of these parameters.

The rail temperature predictions from such a system are expected to provide quantitative information for operation managers, train dispatchers, and maintenance managers in the slow order decision-making process.

ACKNOWLEDGMENTS

The research work presented in this paper is sponsored by the Federal Railroad Administration, U.S. Department of Transportation, under the Operation, Maintenance, Instrumentation and Analysis Support for Railroad Safety Research program. Amtrak provided in-kind support for field validation of the model.

REFERENCES

1. FRA Office of Safety. *Train Accidents*. <http://safetydata.fra.dot.gov/officeofsafety>. Accessed October 20, 2007.
2. Read, D., A. Kish, and D. Clark. Optimized Readjustment Length Requirements for Improved CWR Neutral Temperature Management. AREMA Annual Conference and Exposition, Chicago, Ill., September 9–12, 2007.

MODELING AND FORECASTING TEMPERATURE IN SURFACE TRANSPORTATION

The Road Temperature Forecast Tool**DANIEL BÄTTIG***University of Applied Sciences Bern*

The road temperature forecast tool is an interactive expert system for the winter maintenance service. The tool was developed by the University of Applied Sciences Bern and Meteo Swiss. The aim of the expert system is to make prognostics for a time window of 24 h for the road condition during the winter season. The road surface temperature and possible covering with rainwater, snow, ice, or glazed frost ice are calculated. The algorithm, on which the road temperature forecast tool is based, is—similar to the METRo system—the physical model of the heat equation. Nonlocal parameters involved the seasonal temperatures measured in a depth of 0.70 m (= 2.3 ft) under the road surface, predictions of air temperatures, dew point temperatures, wind directions and velocities, and prognostics of precipitations. Since the topology of Switzerland is not uniform, local parameters such as the horizon or the shading of the road play, in contrast to the METRo system, an important role for the algorithm. The physical model of the heat equation then calculates the temperature forecast of the road. The road temperature forecast tool is implemented in Java 5 and Java 6 and allows the meteorologists to calculate the road state by playing interactively with different weather scenarios.

The road temperature forecast tool is an automatic road weather information system. Such systems have been in use in Europe more than 20 years and have become also widely used in North America. The road forecast tool was developed by the University of Applied Sciences Bern and Meteo Swiss in 2007. It will be tested on different roads and regions in Switzerland during the winter season 2007–2008. The system calculates the road surface temperature and possible conditions such as covering of the road with rainwater, snow, ice, or glazed frost, for the next 24 h. It allows communicating important information to the road maintenance teams to help to plan deicing or snow removal actions. More important, because of the interactive graphical user interface of the implemented tool, a meteorologist can play with different weather conditions to estimate the behavior of the state of a road.

The road temperature forecast tool is based on a physical model for the road temperature. Similar to the METRo system (*1*) the road temperature is calculated with the one-dimensional heat equation. The crucial part of the model is first an accurate description of the heat fluxes between the road surface and the air. This includes handling of water, snow, and ice accumulation on the road. Second, a precise description of the local environment of the road such as shading, altitude, and region of the climate allows having a good knowledge of the heat fluxes.

The system has been implemented in Java 5 and Java 6. It can be operated from any terminal with an Internet connection. Needed meteorological parameters and data sets are transmitted by the http protocol. The incoming data records are coded in the XML form.

THE ALGORITHM: HEAT EQUATION

The temperature $T(x, t)$ of the road in time t and in depth x below the road surface can be calculated with the help of the one-dimensional heat equation

$$\frac{\partial T}{\partial t} = \frac{k}{c \cdot \rho} \cdot \frac{\partial^2 T}{\partial x^2}$$

with the following two boundary conditions:

1. If $x = 0.70$ m (= 2.30 ft), then $T(0.7 \text{ m}, t)$ is given by the seasonal temperature, mainly a harmonic oscillation with period of one year.
2. If $x = 0$ m (= 0 ft), i.e., on the road surface, the gradient of the temperature is modeled by the heat flux HF between the air and the road surface:

$$k_B \frac{\partial T}{\partial x}(x = 0, t) = \text{HF}(t)$$

The heat equation is solved by a discrete scheme of order two following the methods of Crank (2, 3, 4). For fast calculation, methods of linear algebra such as LR-factorizations are used. To get an accurate forecast for the road surface temperature $T(0, t)$, it is important that the heat flux HF is modeled with high accuracy, based on different physical and meteorological parameters. This is done by the following equations: First the energy flow is a sum of two energy terms

$$\text{HF} = \text{energyTotal} + \text{energyCorr}$$

The term *energyCorr* calculates the energy transport due to melting and freezing processes. The term *energyTotal* is the sum of energy flux due to radiation, conduction, convection, and evaporation. As an example, the radiation is proportional to the forth power of the air temperature. Most of these energy fluxes depend not only on the meteorological situation but also on topological and geographical parameters of the neighborhood of the road. Modeling both heat flux terms is based on results of various studies (1, 5–9). Because of the topology of Switzerland, which consists of mountains and hills, parameters for Swiss regions involved in the model are very important. Topological parameters include the shading, the horizon, the altitude, and the type of the climate. The model of Zgraggen (9) determines the values of these parameters.

The Term *energyTotal*

The term *energyTotal* (eT) is written as a sum of different energy fluxes:

$$eT = gRa \cdot (1 - \text{albedo}) + lRaIn - lRaOut - sHF - \text{latHF}$$

The variable *gRa* measures the global radiation. The global radiation is a function of the horizon, and the cloud state. These parameters are given by meteorological models and depend on the region, where the road is located. The variable *albedo* is defined as follows:

$$\text{albedo} = 0.17 + \min(\max(\text{snow} - 1)/5, 0), 1) \cdot (0.5 - 0.17)$$

where snow is the snow reservoir on the road. The constant 0.17 is different from the METRo model with constant 0.1. The next two terms are the long-wave radiation terms, the first measuring the radiation into the road surface, the second measuring the radiation out of the road surface. One has

$$\text{IRaIn} = c_1(273.158 + T_{\text{air}})^4, \text{IRaOut} = c_2(273.158 + T_{\text{surface}})^4$$

where c_1 and c_2 are different constants. Further T_{air} is the air temperature and T_{surface} is the surface temperature. The variable sHF measures the turbulent heat flux at the frontier between the air and the road surface. This turbulent heat flux is proportional to $T_{\text{air}} - T_{\text{surface}}$. The latent heat flux latHF is the heat flux due to condensation of water steam. This parameter is the product of the difference between the specific humidity of the surface temperature and the specific humidity of the dew point temperature, and the condensation energy cE. The last parameter is modeled by the function

$$cE = 2779.689 - 51.59822 \cdot \left(\frac{273.158 + T}{100}\right) - 3617.647 \cdot \left(\frac{273.158 + T}{1000}\right)^2$$

The Term energyCorr

The term energyCorr (eCorr) calculates correction to the energy flux due to melting and freezing processes. It can be written as

$$e\text{Corr} = eR + eS + eI + eP - \text{cor}$$

The first three terms eR, eS, and eI are responsible for the modeling of melting and freezing processes due to rain, snow, and ice. The summand eP determines the heat flux due to melting and freezing processes of precipitation, as freezing rain (cold road surface) or melting snow (warm road surface). The term cor calculates correction to the energy flux due to melting and freezing processes in the case that the surface temperature is bigger or lower than the melting temperature of the snow. Detailed information on how these parameters are modeled can be found in Bättig et al. (10).

The State of the Road

The road temperature forecast tool determines the state of the road surface as a function of the cumulated rain, snow, or ice amounts measured in kg/m^2 . To simulate the evolution of water, snow or ice at the road surface, a system of reservoirs is used. This system is similar to that of (11). Table 1 shows how the state is defined as a function of these reservoirs.

Here is an example: if the ice amount is greater than 0.2 kg/m^2 and the surface temperature is greater than 0°C then the state of the road is ice.

TABLE 1 Determination of the Road State

Road Condition	Dry	Wet	Snow	Frost	Ice
Rain amount < 0.2 kg/m ²	Yes	No			
Snow amount < 0.2 kg/m ²	Yes	Yes	No		
Ice amount < 0.2 kg/m ²	Yes	Yes		No	No
Snow amount > ice amount			Yes		
Rain intensity < 0.1/3600 kg/(m ² /s)				Yes	
Snow intensity < 0.1/3600 kg/(m ² /s)				Yes	
Surface temperature < 0				Yes	
Surface temp. < dew point temp.				Yes	

THE TOOL IN JAVA

The road temperature algorithm has been implemented in Java 6. The program can be executed from any terminal with an Internet connection to the server at the Meteo Swiss. The specifications of the program are formulated in a 2006 report (12).

The algorithm calculates road temperatures for different regions in Switzerland. The regions are characterized by the fact that the weather situations such as wind, cloud, and precipitation states do not differ much inside the regions. In a first step the meteorologist has to choose such a region. This is shown in Figure 1.

The meteorologist, on the basis of weather stations of the considered region, then makes a prognostic for the wind parameters (velocity and direction), cloud and precipitation states, the air temperature, and the dew point for the next 24 h. The computer program has to process the correct arrival of these data streams, which are transmitted via the http protocol. The data records are coded in the XML format whereas the records of the different data sources may arrive in arbitrary order. After data are received, the XML structure is validated against a defined schema. If the data records are valid, they are given a timestamp and are stored into the corresponding database table.

The road temperature forecast tool calculates the temperature curve and the state of the roads in the specified region. The possible states of the roads are coverings with rainwater, snow, ice, or glazed frost ice. The output of the program is shown in Figure 2.

**FIGURE 1 Example of choosing a region.**

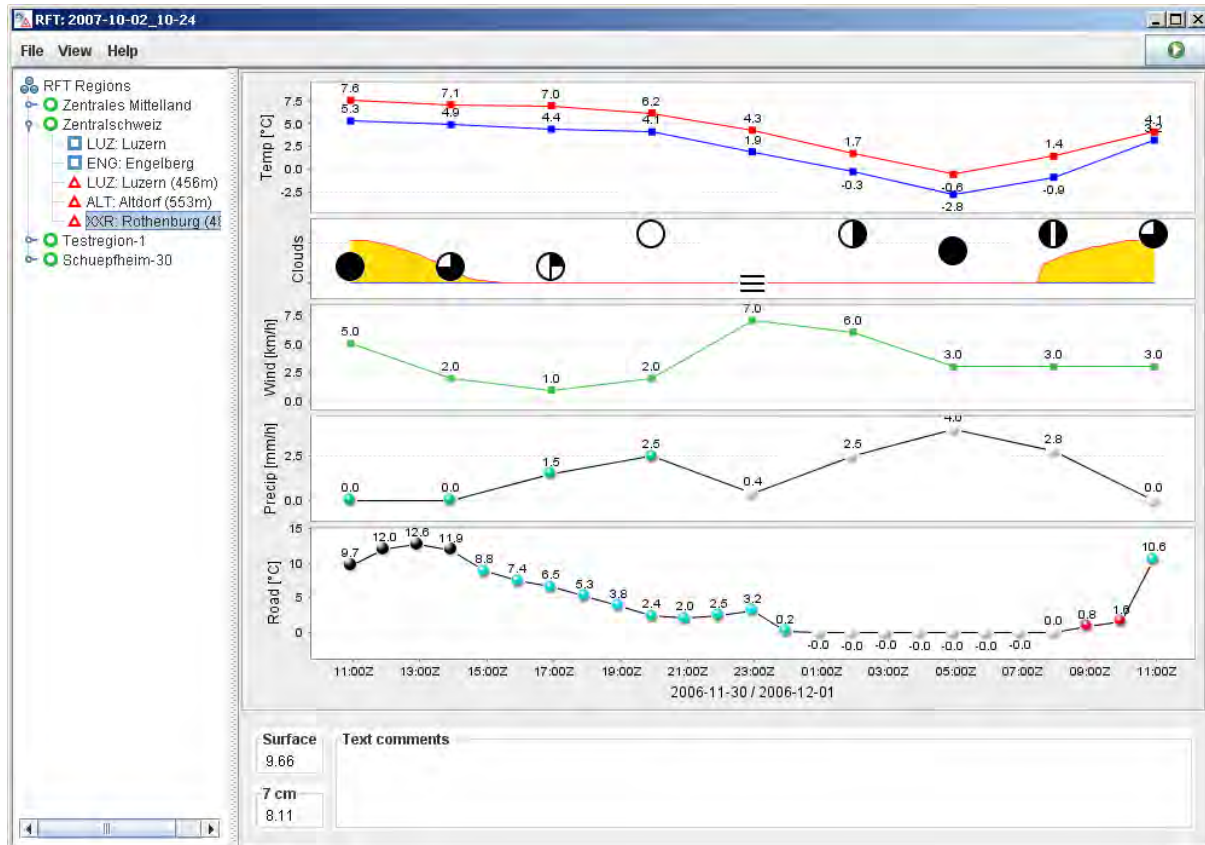

FIGURE 2 Graphical user interface of the road temperature forecast tool.

Interactive Output–Input Windows

The graphical user interface of the program is separated into five subwindows. The first four windows visualize the input parameters of the program.

Subwindow 1. The two curves show the air temperature 2 m aboveground and the dew point temperature. Both curves are given by the meteorologist or by weather models (Figure 3).

Subwindow 2. This subwindow (Figure 4) shows the portion of the sky cover that is attributed to clouds. It is measured in eighths (oktas). The intensity of the sun is also shown in yellow color. This allows a user to determine the time of the sunrise and the sundown. Also if a road has data of the horizon, the time of the sunrise and the sundown are corrected appropriately.

Subwindow 3. This window (Figure 5) shows the wind direction 2 m above the road.

Subwindow 4. The intensity of the precipitation is measured in mm/h. The type of the precipitation is visualized by different colors of the points: turquoise for rain, white for snow (Figure 6).

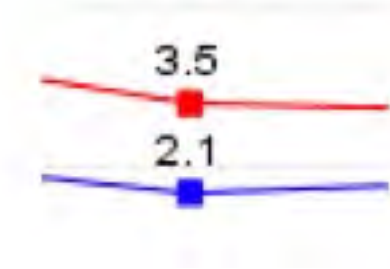

FIGURE 3 Subwindow 1.

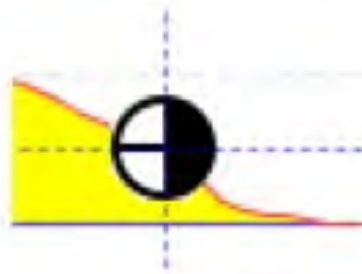

FIGURE 4 Subwindow 2.

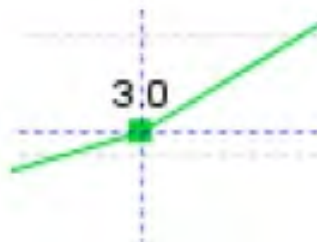

FIGURE 5 Subwindow 3.



FIGURE 6 Subwindow 4.

The time series of the four subwindows can be changed interactively. This allows the user of the program to calculate different weather scenarios and to visualize the consequences of different weather situations for the state and the temperature of the road.

Output: Road Forecast

The last subwindow (Subwindow 5) shows the calculation of the road temperature forecast tool (Figure 7).

The surface temperature of the road and the state of the road are presented: black points indicate a dry road surface, turquoise points mean a wet road surface, red points show widespread ice, white points indicate snow covered roads, and finally violet points stand for hoar frost. If the road surface is in a state of widespread ice and snow cover, widespread ice is visualized.

SOME RESULTS

The road temperature forecast tool was tested on several meteorological situations. To measure the accuracy of the implemented algorithm, an exact measure of the state of the roads and the weather parameters had to be done. This ensured that the state of the road was known up to an error rate of maximum 0.5°C ($= 0.9^{\circ}\text{F}$). Figure 8 shows an example of such an evaluation for the road surface temperature during 24 h, beginning and ending at noon.

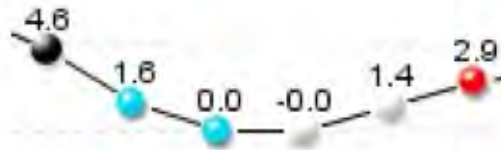

FIGURE 7 Subwindow 5.

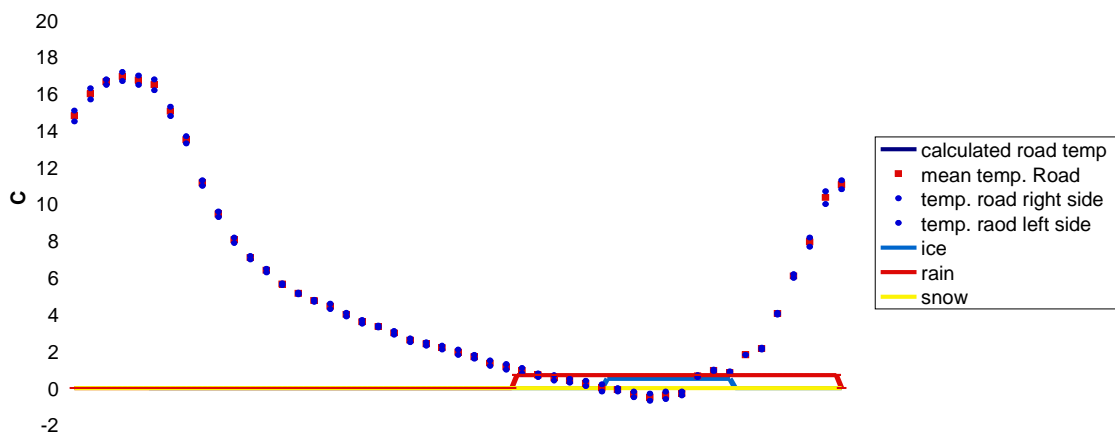

FIGURE 8 Road surface temperature, calculated and measured.

The figure indicates that the road temperature forecast tool predicts the road surface temperature during nighttime up to an error of $\pm 2^{\circ}\text{C}$ ($= \pm 3.6^{\circ}\text{F}$). In the example the tool calculates the time very well when the road surface temperature passes 0°C ($= 32^{\circ}\text{F}$). Nevertheless it is not possible to make short-term predictions of the temperature: the calculated temperature curve is much lower than the actually measured road temperature during the first 2 h of the calculation. This is because the initial condition temperature $T(x, 0)$ of the temperature for x between 0 m and 0.7 m ($= 2.30$ ft) is not known. In contrast to the METRo system, the road temperature forecast tool of Meteo Swiss does not try to construct the initial road temperature profile with the help of the calculated information of the past 2 days. Instead the system works with a stepwise linear profile of the temperature, based on measures at the road surface, at a depth of 0.07 m and the seasonal temperature at 0.7 m below the road surface.

REFERENCES

1. Crevier L.-P., and Y. Delage. METRo: A New Model for Road-Condition Forecasting in Canada. *Journal of Applied Meteorology*, 2001, pp. 2026 – 2037.
2. Ames, W. F. *Numerical Methods for Partial Differential Equations*. Academic Press, Inc., Boston, 1992.
3. Crank, J. *The Mathematics of Diffusion*. Oxford Science Publications, Oxford University Press, 1975.
4. Evans, G., J. Blackledge, and P. Yardley. *Numerical Methods for Partial Differential Equations*. Springer London, 2000.
5. Barkstrom, B. R., E. F. Harrison, and R. B. Lee. Earth radiation budget. Preliminary seasonal results. *Eos*, Vol 71 No. 9, 1990, pp. 279, 299, and 304–305.
6. Hartmann, D. *Global Physical Climatology*. Academic Press, Inc., Boston, 1994.
7. Jones, P.D., M. New, D. E. Parker, S. Martin, and I.G. Rigor. Surface air temperature and its changes over the past 150 years. *Reviews of Geophysics*, 37, 1999, pp. 173 – 199.
8. Ohmura, A., and H. Gilgen. Re-Evaluation of the Global Energy Balance. *Geophysical Monograph* 75, IUGG, Vol. 15, 1993.
9. Zraggen, L. *Strahlungsbilanz der Schweiz*. Diss.ETH Nr. 14158, ETH Zürich, 2001.
10. Bättig, D., St. Stankowski, and E. Wyler. *Energiebilanzmodell EBM*. Technischer Bericht, University of Applied Sciences Bern, 2007.
11. Sass, B.H. A numerical model for prediction of road temperature and ice. *Journal of Applied Meteorology*, Vol. 36, 1992, pp. 801–817.
12. *Pflichtenheft Road Forecast Tool (RFT), VI.1*. MeteoSchweiz, 2006.

MODELING AND FORECASTING TEMPERATURE IN SURFACE TRANSPORTATION

**Spatial and Temporal Mapping of Pavement Temperatures
for Optimal Winter Road Maintenance Operations****L. FU****B. HASHEMLOO****F. FENG***University of Waterloo***MAX S. PERCHANOK***Ontario Ministry of Transportation*

The pavement temperature profile of a maintenance route is a critical input to various winter road maintenance decisions, such as where to direct maintenance vehicles (i.e., icy spots), when to start salting, and how much salt to apply. Pavement temperatures are commonly collected by road weather information systems (RWIS) and infrared thermometers (IRT) installed on patrol vehicles or maintenance trucks. These technologies, however, have limitations: RWIS provides only point measurements at a fixed location along a maintenance route, lacking spatial coverage; thermal mapping using IRT provides infrequent snapshots of pavement temperature over a snowstorm. The objective of this research is to develop a complete view of pavement temperature over space and time by integrating these two data sources through a set of locally calibrated models. The major idea behind the proposed approach is the recognition of variation patterns that commonly exist in pavement temperatures within a plow route due to local weather conditions, road geometry, and highway terrain. Data for two highway maintenance routes in eastern Ontario, Canada, were collected by IRT over several snowstorm events in February and March of 2007. The routes are also equipped with RWIS that provided continuous data of road surface temperature at one location. Weather and pavement contaminant properties were recorded and correlated with temperature data. ARIMA models are developed to map temporal variation of pavement temperatures at specific locations. Regression models are developed to correlate temperatures at two different locations at specific time intervals. These models, representing the pavement thermal signatures of a maintenance route, make it possible to map pavement temperatures on the basis of RWIS data and sparse patrol data.

MODELING AND FORECASTING TEMPERATURE IN SURFACE TRANSPORTATION

Night Icing Potential Demonstration Project**PAUL J. DELANNOY****SHAWN ALLAN****TERRY M. BULLOCK****JOHN D. MCCLINTOCK****GREG MOFFATT****DAVID ROBBINS****ROBERT SAYER****PHILIP WOODHAMS***AMEC Earth and Environmental***PAUL RICHARD****BERNIE MACDONALD***Nova Scotia Transportation and Public Works*

This paper presents a very cost-effective approach for the preparation of thermal fingerprints and the forecasting of potential night icing situations. A Nova Scotia Transportation and Public Works (NS TPW), Canada, patrol vehicle equipped with an infrared (IR) sensor and an automatic vehicle location (AVL) service was used to perform IR data runs along a section of Highway 104 in Pictou County, Nova Scotia. The signal from the IR sensor was fed directly into the AVL unit, which relayed the positional, timing, and temperature information directly to the AVL provider, Grey Island. AMEC meteorologists coordinated the IR runs with NS TPW staff and extracted the Grey Island AVL data daily for analysis against the weather from the previous night. The data were mathematically filtered, aligned, and averaged. Thermal fingerprints for three weather types (extreme, intermediate, and damped) were produced in a geographic information system (GIS) format. The thermal fingerprints for Highway 104 were then associated with the two roadway weather information systems along the route. The route was divided into equal segments, and the coldest temperature deviation from the mean along each segment was assigned to the entire segment. Forecasts of pavement temperature and air dew point were used with the fingerprint corresponding to the coming nights prevailing forecast weather to determine the earliest time at which frost could form for each road segment. The resulting GIS map with color-coded road segments and time stamps of the potential onset of icing provides an effective new road maintenance operations planning tool. A GIS-based format for thermal fingerprints and forecast presentation will be presented. The logic and steps in the production of this innovative night icing potential chart product will be presented and its limitations described.

Thermal imaging of roadways using infrared (IR) sensors was first developed about two decades ago. IR sensing has been used to quantitatively describe the thermal behavior of a roadway at night under various weather conditions along its entire length (L). The diagrams produced are generally referred to as thermal fingerprints. As more roads in an area are fingerprinted, a two-dimensional thermal map for an entire road network, or part of it, can be produced.

Roadway weather information systems (RWIS) monitor atmospheric and pavement conditions at a single point and forecasts of future road surface temperature and condition provide a solution only at the RWIS locations. Thermal fingerprints provide a means of determining which road segments are colder or warmer than its associated RWIS site and can be used to forecast pavement temperatures along the entire length of the roadway at night. These products are particularly effective winter maintenance tools in mild and very moist winter climates such as are found in the southern United Kingdom, where the formation of frost on roadways is a dominant winter road maintenance problem. Using RWIS data and forecasts together with thermal fingerprints provides a means of determining where along a roadway surface temperatures may drop to below 0°C over the coming night. With early morning relative humidity values in excess of 97% on virtually all nights, one can then assume a high likelihood that frost will form on those sections of roadway where road surface temperatures dip below freezing.

For cold, snowy winter climates such as are found through most of southern Canada, the formation of frost on roadways presents a greater challenge. Road surface temperatures can be well below freezing the entire night all along the full length of the roadway, but frost may not be present at all or form only along some sections. This is because all of the necessary conditions for frost to form on the roadway have not been met. Specifically, road surface temperature must drop to below freezing and the road surface temperature must be below the air dew point. To forecast where and when frost will form, if at all, one must determine where and when road surface temperatures will meet these two conditions.

Producing thermal fingerprints and thermal maps in the traditional manner was prohibitively expensive in cold climates where the formation of frost on roadways is less prevalent and the benefits to be gained smaller. Further, the ultimate end use of these products had never been advanced to the point of providing a simple, operationally useful product to guide the maintenance decisions of road supervisors. Still the formation of black ice on roadways is a particularly insidious road hazard that is especially difficult to deal with. Though much less frequent in Canada, this treacherous phenomenon needs to be addressed. Modern informatics tools can be effectively applied to determine precisely when and where there is a night icing potential. This paper provides some new approaches.

COST-EFFECTIVE THERMAL FINGERPRINTS

This demonstration project used a very cost-effective approach for the preparation of thermal fingerprints. Officials of the Nova Scotia Transportation and Public Works (NS TPW) department acquired all of the IR data themselves. A patrol vehicle was already suitably equipped with a Sprague RoadWatch IR sensor and an automatic vehicle location (AVL) unit. The AVL service provided by Grey Island Systems Inc. collects vehicle location and time information using the Global Positioning System (GPS) and provides this information back to NS TPW through the Internet. The IR sensor was interfaced directly into the AVL unit so that road surface and air temperatures from the RoadWatch unit were also relayed to Grey Island along with the location and time information. In this way, NS TPW assumed, as part of its regular road patrolling, the data acquisition portion of the thermal fingerprint production process.

A section of Highway 104 in Pictou County, Nova Scotia, was selected for this demonstration project (Figure 1). The test length commenced just east of New Glasgow and ran

42 km along the 104 to the Pictou County line halfway to Truro. There are two RWIS sites along the route: Upper Mount Thom and Mount William Road. The terrain varies significantly along the route, with Mount Thom known to be particularly prone to dangerous driving conditions due to local weather and elevation effects.

All of the runs were performed starting from the west end of the route and driving in the east-bound (EB) lane. The Sprague RoadWatch IR sensor claims to be able to sense a 1°C surface temperature change in $1/10$ of a second (accuracy of $\pm 1^{\circ}\text{C}$ and a response time of 0.1 s). The Grey Island AVL unit was able to provide regular position, and therefore temperature and time fixes, at 2-s intervals. Shao and Lister (2) recommend a sampling interval of 4 to 5 m. For this reason, the speed of the patrol vehicle was slowed to 35 km/h (9.7 m/s). This provides a set of temperature and locations readings at intervals of 20 m or about 2,100 data points per run along the test route.

Thermal fingerprints are generally produced for three set weather types: extreme, intermediate, and damped (3). Extreme in this case means clear and calm conditions which yield the most extreme temperature variations along the road surface. Intermediate is defined as partly cloudy conditions with light to moderate winds. Damped refers to the weather conditions that will yield the least temperature variation along the roadway: overcast and windy conditions.



FIGURE 1 Demonstration area.

MODERN THERMAL FINGERPRINTS

AMEC meteorologists coordinated the IR runs with NS TPW staff. IR run data were extracted daily and analyzed against the weather from the previous night along the route. Twenty-three runs were performed over the period February 6 to March 13, 2007. The analysis consisted of the following steps:

1. Confirmation of suitability and classification according to weather type;
2. Fixing of the run start and end points;
3. Calculation of mean road surface temperature for the entire run and deviations from the mean for each data point;
4. IR data filtering of the road surface temperature deviations from the mean;
5. Positional alignment of run data; and
6. Averaging of multiple runs under the same weather condition classification.

Runs were classified as extreme, intermediate, damped, or unusable. Whenever there had been any precipitation of any type, the roads had been treated, or there were weather fronts moving through the area, the run was deemed unusable and discarded.

Occasionally, the IR sensor was not able to acquire a reading, and errors, coded as 999, appeared in the road surface temperature data. These needed to be removed. Since runs were not all started at exactly the same point and the speed varied during each run, careful alignment of the data sets from successive runs was required. The easternmost start point from the west end of the route over all of the runs was chosen as the common start point and all data west of this point were discarded. Similarly, the westernmost end point at the east end of the route was established as the common end point for all runs.

The average road surface temperature for the entire run was then calculated. For each data point, the mean road surface temperature for the run was subtracted from the actual road surface temperature. This gave the deviation from the mean along the run and identified those road segments that were warmer and colder than the mean.

The road environment was quite dirty, with many surface irregularities and slight variations in vehicle speed causing the IR data to be noisy. Cleaning the data consisted of removing spurious outlying data points. A nonrecursive, low-pass adjustable filter described in Shao and Lister (2) was used for this purpose.

Latitudes and longitudes provided with the AVL service were used to calculate the actual position along the route from the start point. In this way, the curves generated from successive runs could be lined up correctly for comparison and averaging. Finally, output curves from the collection of runs according to each weather type were averaged to arrive at a single filtered and averaged IR fingerprint for each weather type: extreme, intermediate, and damped.

The next exercise was to confirm that the classic thermal fingerprint reported in the literature (4) could be produced. Figure 2 shows the thermal fingerprint for the extreme case for Highway 104. Two graphics are aligned vertically in the figure: the abscissa of the top graph is distance in kilometers along the roadway while that of the bottom graph is longitude along the roadway. These are correctly aligned. The ordinate of the bottom section of the diagram provides elevation of the roadway, in meters, above mean sea level, while the ordinate of the upper section provides the deviation of the road surface temperature from the mean in degrees Celsius.

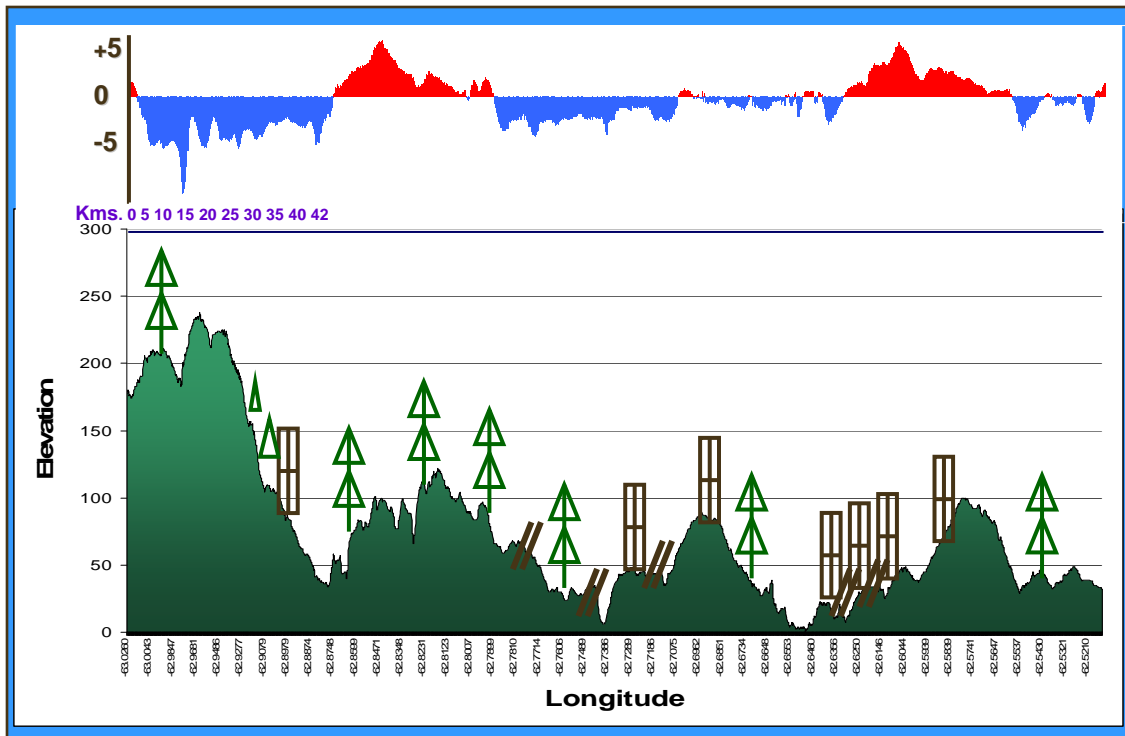

FIGURE 2 Classic extreme thermal fingerprint for Highway 104 in Nova Scotia.

The shapes that appear in the lower part of the diagram are rudimentary indicators of physical features along Highway 104. Rectangles represent built-up areas while green triangles represent vegetation and, when stacked vertically, treed areas. Parallel lines denote overpasses or bridges.

The classic representation of thermal fingerprints predates the development of geographic information systems (GIS) applications that offer significant advantages for the representation of thermal fingerprints. Figure 3 is a modern representation of the same Extreme thermal fingerprint for Highway 104 in Nova Scotia in a GIS map application. The diagram is composed of an upper panel representing the western half of the route and a lower panel representing the eastern half of the route. Since land cover also influences road thermal behaviour, the legend in the upper left corner provides the color code for the land cover. This is provided in the two panels as a two-dimensional aerial view surrounding the road and adjacent areas. The GIS database provided by NS TPW allowed selections from nearly 100 different land use categories for analysis, allowing the richer representation to be user definable.

The insert in the middle right provides an aerial two-dimensional view of the terrain features along the route. The terrain mapping colors range from aqua for sea level to dark brown for 442 m above sea level. This is important since the road's thermal behavior is more a function of the lay of the land spatially in two dimensions than just the instantaneous elevation along the road itself.

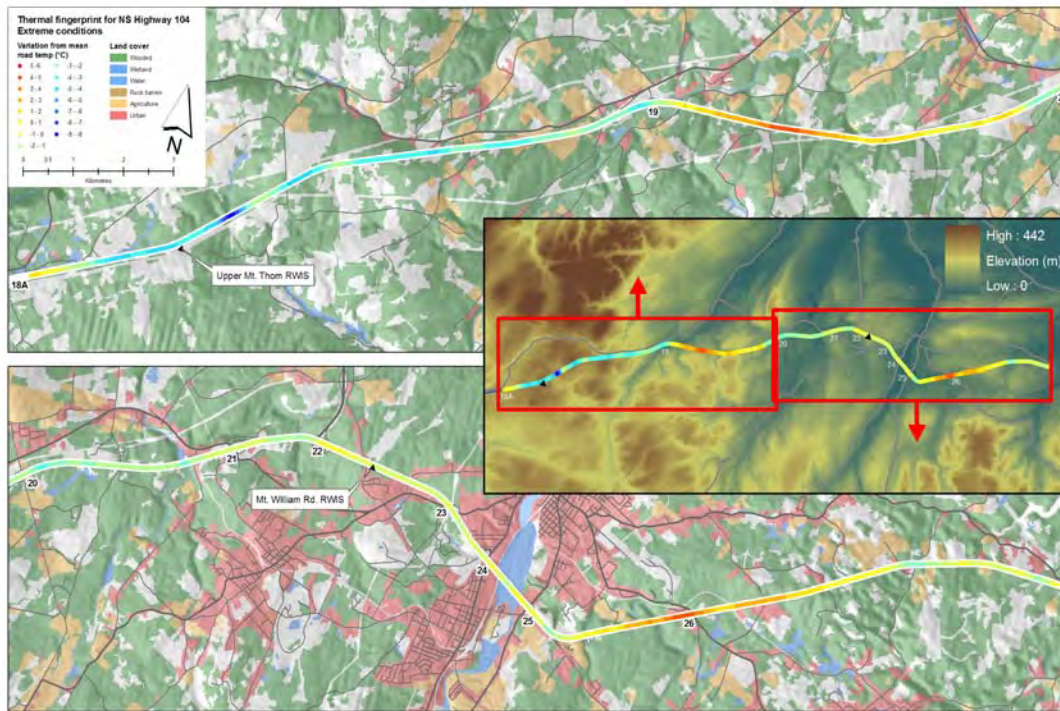

FIGURE 3 Modern thermal fingerprint (extreme) for Highway 104 in Nova Scotia in GIS format.

The legend in the upper left of Figure 3 also provides the color code for the temperature variations from the mean (not from 0°C) of all temperatures along the route for this extreme case. The temperature variations along the roadway are represented in color on the road itself in the upper and lower panels of land cover and in the topographic insert in the middle right. The precise location of the two RWIS along this portion of Highway 104, Upper Mt. Thom and Mt. William Road, are also provided.

This GIS representation for a thermal fingerprint provides much more information than the classic representation. Users can import and display other land cover data for analysis and can very easily modify the whole representation at will. Finally, the thermal fingerprint data itself can be imported into other GIS applications for other purposes. Thermal fingerprints for the three weather types were produced in this format and made available as a digital layer for other RWIS applications.

OPERATIONAL NIGHT ICING POTENTIAL SERVICE

The modern thermal fingerprint presented in Figure 3 is a powerful tool that imparts an enormous amount of information about the road's thermal behaviour. As such it possesses intrinsic value for winter road maintainers newly assigned to that section of Highway 104. It allows individuals to acquire, through 15 min of study, the intimate knowledge of the roadway's

thermal behavior that would otherwise have taken many years of working the road. Despite this, the modern thermal fingerprint in this form remains a challenge to use operationally.

More work was required to develop a simple tool to determine which road segments on a given night might be subject to the formation of frost and, if there was a night icing potential, when would frost form and on which specific segments along the road. The following steps were required:

1. Associate portions of the roadway with one of the two RWIS sites,
2. Break the roadway up into discrete segments, and
3. Determine the temperature differential from the associated RWIS for each roadway segment.

Figure 4 illustrates the first step: association. A relationship was needed between different road segments and a neighboring RWIS station, since forecasts prepared for the RWIS sites provide the starting point in assessment of night icing potential (NIP). Since there are two RWIS stations along this 42-km stretch of Highway 104, a coarse first-guess association could have been done simply by dividing the route in half and assigning the west half to the Mt. Thom site and the eastern half to the Mt. William site.

Figure 4 provides all three thermal fingerprints: extreme in red, intermediate in purple, and damped in blue, together with the elevation curve in green. All three curves converge at a point approximately one-third of the way from the western end of the route. This also corresponds roughly to the base of Mt. Thom and provides a suitable break point in the association exercise. The western third of the route was therefore associated with the Mt. Thom RWIS site. The eastern two-thirds of the route were associated with the Mt. William RWIS site, which happens to be approximately halfway along the eastern two-thirds of the route.

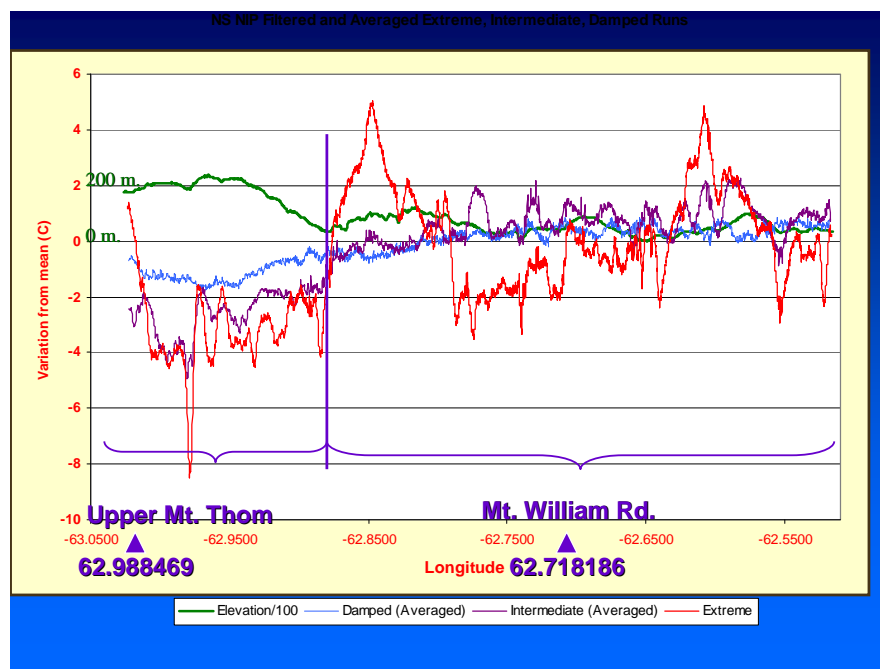

FIGURE 4 Association of road portions with RWIS sites.

Next each portion of the route needed to be divided into a number of smaller segments. Several attempts were made to devise segments of differing lengths according to the variability of temperature along the roadway or other land cover and elevation features. To continue with such an approach would have been extremely difficult and time consuming. In the interest of efficiency and to facilitate automation, it was decided to proceed with segments of equal length. Equal segment lengths of 2 km each, 1 km each, and 250 m each were tried. Segments of 1 kilometer length provided an optimal resolution for a highway application such as this. Although it was felt that 250-m segments were too fine, they may work well in an urban setting.

The final step was to determine the temperature differential from the associated RWIS site for each of the kilometer-long segments, and for each of the three weather types. In order to err on the side of caution, the coldest departure from the route mean temperature was selected for each segment.

With the thermal fingerprint portions now associated with the appropriate RWIS site and the temperature differentials calculated for each road segment for each weather type (extreme, intermediate, and damped), an operational NIP service that works in a cold climate is possible. The requirements for the formation of frost, a night icing potential, along any segment are

$$T_r \leq 0^\circ\text{C}$$

and

$$T_r \leq T_d$$

where T_r is the temperature of the road surface and T_d is the air dew point temperature. The steps in the provision of a NIP service are as follows:

1. Prepare atmospheric forecasts including wind, cloud cover, and dew point for each RWIS site;
2. Run a heat–balance model to produce a pavement temperature forecast for each RWIS site;
3. Type class the weather over the route for the coming night as extreme, intermediate, damped, or unsuitable;
4. Select the corresponding segmented thermal fingerprint for the route;
5. Using the RWIS forecast and the appropriate fingerprint for the coming night, calculate the forecast road surface temperature for each segment for each hour through the night;
6. Determine if the forecast road surface temperature for any segment will dip below zero and below the forecast air dew point for that time of the night and note the time at which this would occur; and
7. Prepare a GIS map with these times for each segment.

NIP CASE STUDY

The process described above is best illustrated and understood by reviewing an actual case. [Figure 5](#) provides the RWIS forecast for Mt. Thom for the night of March 12–13, 2007. The weather was forecast to be clear and calm over central Nova Scotia, giving it a NIP classification

of extreme. Note that the air dew point temperatures were forecast to rise nearly 10°C during the night. With skies clear after a clear day, the warm, nearly 15°C afternoon pavement surface temperature was forecast to plummet, falling below zero by 20:00, then to below the air temperature at 22:30. At Mt. Thom itself, pavement temperature would not fall to below the air dew point until just before 03:00 on the morning of March 13. This is the earliest time at which frost would form at the Mt. Thom RWIS site. The goal was to determine if there was a potential for frost, a NIP, for any other segments of the stretch of Highway 104 in Pictou County, and if so, at what time?

Table 1 provides the same forecast road surface and dew point temperatures as are represented in Figure 5. The difference between these two values, the forecast – diff column, becomes negative at 03:00 on March 13. With forecast pavement temperatures at that time below 0°C and below the air dew point, there was a Night Icing Potential at the RWIS site just before that time. Conditions remained conducive for NIP up to 10:00 on March 13.

Other road segments along Highway 104 in Pictou County can be several degrees warmer or colder than the forecast pavement temperatures at the Mt. Thom site itself (see the rightmost six columns in Table 1). For road segments that are 3°C warmer than Mt. Thom, we can simply add +3 to the $T_r - T_d$ values in the difference column. Conditions for NIP are just barely met at 09:00, March 13. The same process can be repeated for road segments that are +2°C, +1°C, -1°C, -2°C, -3°C, etc., difference from the Mt. Thom site. Note that the calculation is performed using the forecast air dew point temperature for each successive hour in the night.

We see that for road segments that are much colder, the onset of frost will be much earlier than at Mt. Thom. For warmer road segments, the onset of frost will be later than at Mt. Thom. Proceeding in this way, the earliest possible time for the onset of frost can be determined for each kilometer-long road segment. Once these times are determined, they can be plotted for each road segment in a GIS application. The resulting NIP chart for the west end of Highway 104 in Pictou County for the night of March 12–13, 2007, is provided in Figure 6.

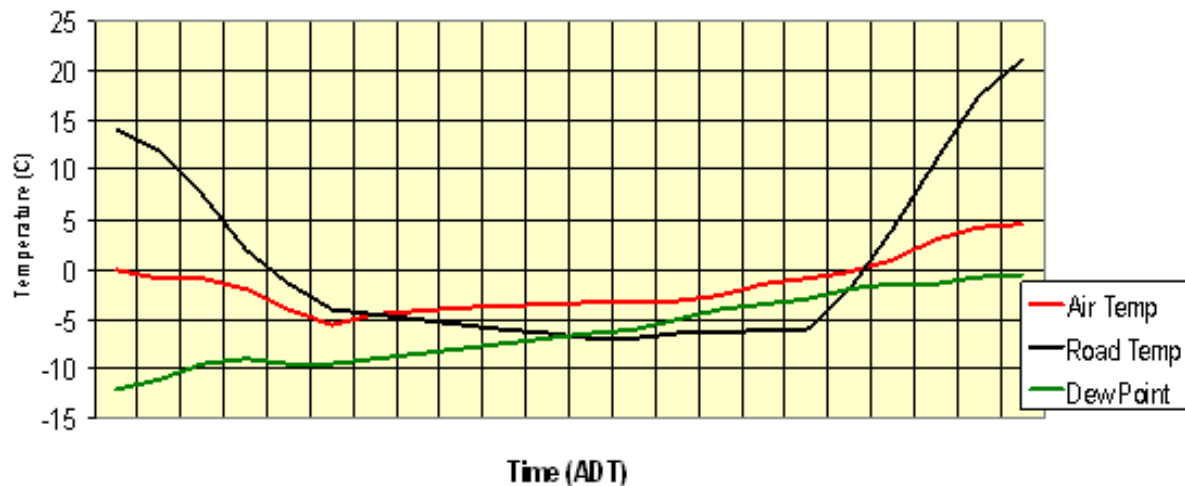

FIGURE 5 RWIS forecast for Mt. Thom for the night of March 12–13, 2007.

TABLE 1 NIP Forecast for Mt. Thom and Adjacent Road Segments, March 12–13, 2007

Date	ADT	Forecast				Road Segments					
		Road Temp	Dew Point	Diff		+3	+2	+1	-1	-2	-3
12	9	-4	-9.5	5.5		8.5	7.5	6.5	4.5	3.5	2.5
12	10	-4.5	-9	4.5		7.5	6.5	5.5	3.5	2.5	1.5
12	11	-5	-8.5	3.5		6.5	5.5	4.5	2.5	1.5	0.5
12	12	-5.5	-8	2.5		5.5	4.5	3.5	1.5	0.5	-0.5
13	1	-6	-7.5	1.5		4.5	3.5	2.5	0.5	-0.5	-1.5
13	2	-6.5	-7	0.5		3.5	2.5	1.5	-0.5	-1.5	-2.5
13	3	-7	-6.5	-0.5	NIP	2.5	1.5	0.5	-1.5	-2.5	-3.5
13	4	-7	-6	-1	NIP	2	1	0	-2	-3	-4
13	5	-6.5	-5	-1.5	NIP	1.5	0.5	-0.5	-2.5	-3.5	-4.5
13	6	-6.5	-4	-2.5	NIP	0.5	-0.5	-1.5	-3.5	-4.5	-5.5
13	7	-6	-3.5	-2.5	NIP	0.5	-0.5	-1.5	-3.5	-4.5	-5.5
13	8	-6	-3	-3	NIP	0	-1	-2	-4	-5	-6
13	9	-2	-2	0	NIP	3	2	1	-1	-2	-3
13	10	4	-1.5	5.5		8.5	7.5	6.5	4.5	3.5	2.5

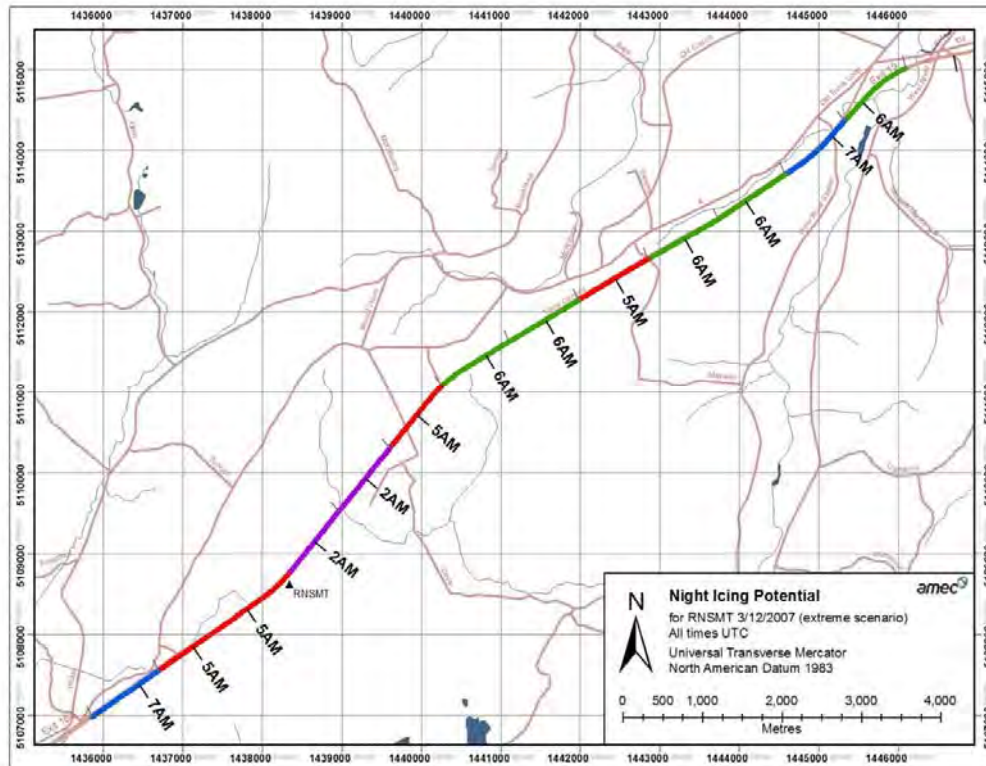

FIGURE 6 NIP chart for Mt. Thom for the night of March 12–13, 2007.

STRENGTHS AND LIMITATIONS

The new NIP product has been well received by the target user community: winter road maintainers. It is a valuable aid for winter road maintenance supervisors dealing with potential frost events, which are particularly difficult to deal with. Based on the forecast for the RWIS site, the atmospheric forecast, and the appropriate thermal fingerprint for the prevailing forecast weather type, NIP provides a guide as to where frost may form, if any, and the earliest time for the onset of frost for each road segment. Prepared in the middle of the afternoon for the coming night, it provides an excellent planning tool for the winter maintainer, who can then schedule road patrols for the various segments at about, or shortly after, the earliest frost onset time. The alternative would be to plan patrols for many more hours on many more nights or, worse, needlessly pretreat roads on many more nights.

It has been shown [see Shao et al. (5)] that once the thermal maps have been prepared, they can be used with confidence for many years. So the IR data collection needs to be done only once along with the association with the three weather types. This is because the physical features surrounding the roadway typically do not change drastically from year to year so the road's thermal characteristics do not change. Once major new construction on the roadway or immediately adjacent to the roadway is completed or some seismic event occurs that disrupts the road's thermal properties, then the thermal maps would have to be redone over the affected segments.

In some jurisdictions, there would be no labor savings because of contractual arrangements. However, there would still be savings in fuel and wear and tear on the patrol vehicle as well as savings in salt expenditures. There would also be reduced exposure to liabilities. Indirect benefits would include enhanced safety for the motoring public as well as reduced greenhouse gas emissions (fewer patrols) and reduced salt loading in the environment.

It can be shown that with the use of cost-effective thermal map preparation approach described earlier, the NIP service can pay for itself quite easily based on salt savings alone. Clearly, though, the savings are substantially more than just that. The completion of detailed cost-benefit analyses is best left to individual maintenance organizations that are better able to define and quantify their specific categories and amounts of savings.

NIP does have limitations. The thermal response of the roadway along its entire length is mapped and is used as a thermal fingerprint. However, there has been no attempt to resolve the moisture variations along the roadway that may arise with certain wind directions or at different points in the winter season. Even on clear, calm nights, the moisture fluxes along a roadway can be quite large and more complex than even the thermal response.

The NIP product simply uses the forecast dew point temperatures for each hour in the night prepared for the RWIS sites and applies those evenly for the entire route. The fact that the forecast dew points for each hour in the night are used helps. As the RWIS density increases, the NIP product will become better and better as it adds greater moisture flux resolution.

This shortcoming, not resolving the moisture fluxes, is what motivated the selection of the name for the product and service: NIP. NIP does not profess to be an absolute categorical forecast of frost formation. What it tries to determine is first if frost could form anywhere along the route and, if so, when and where along the route the potential for frost formation exists. It has several features built in, selecting the coldest temperature for each kilometer-long segment of the road and applying it over the whole segment, for example, so that NIP will provide the earliest time at which the potential for frost formation arises.

OPERATIONAL EVALUATION

The NIP service was tested operationally in the late spring of 2007 for several weeks and again for nearly 2 months in the fall of 2007. The tests consisted of the preparation of RWIS forecasts for the two RWIS sites, Mt. Thom and Mt. William, and the preparation of the NIP output charts for those nights with a potential for icing along one or more road segments. NS TPW arranged patrols on the nights with some frost expected to determine if signs of frost could be detected in the appropriate segments between the RWIS sites and beyond in Pictou County.

Preliminary analysis of the data confirms that the NIP product is good at determining if frost is possible in any of the road segments. For most occasions where frost was expected somewhere along the road, patrols confirmed frost formation, although not always in the forecasted segment. Patrols were also conducted on nights when frost was not forecast for any road segments but conditions were close to being met. None of those patrols detected any frost under these conditions. Evaluation of the data collected is ongoing at the time of this writing.

CONCLUSIONS

This project achieved the following:

- It demonstrated an efficient cost-effective approach for the preparation of road thermal fingerprints;
- It used GIS applications to advance the state-of-the-art in the presentation of road thermal fingerprints; and
- It devised an operational service, NIP service, for use in cold snowy climates to determine through the use of RWIS forecasts, together with the thermal fingerprint for the prevailing weather type, which and when specific road segments would be susceptible to frost formation overnight.

Preliminary analysis of the test results from a limited trial period indicates that the NIP service is performing quite well. NIP has not missed any frost events, which would be the most serious error it could commit since roads would remain untreated and dangerous driving conditions would possibly be present. A closer analysis of the test period results is under way and will be reported on. Testing on a larger scale is recommended.

ACKNOWLEDGMENT

The authors wish to thank the Nova Scotia Transportation and Public Works Department (NS TPW), without whose support this demonstration project could not have been completed. The authors also wish to recognize the close collaboration with Bernie Macdonald of NS TPW in collecting the data needed for the preparation of the thermal fingerprints and in conducting patrols to verify the performance of the NIP service.

REFERENCES

1. Gustavsson, T., and J. Bogren. Thermal Mapping by Use of Infrared Technique. *Proc., 4th International Conference on Weather and Road Safety*, Florence, Italy, November 8–10, 1988.
2. Shao, J., and P. J. Lister. Data Filtering for Thermal Mapping of Road Surface Temperatures. *Meteorological Applications*, Vol. 2, 1995, pp. 131–135.
3. Thornes, J. E. Thermal Mapping and Road-Weather Information Systems for Highway Engineers. *Highway Meteorology* (A. H. Perry and L. J. Symons, ed.), E&FN Spon, London, pp. 39–67.
4. Shao J., J. C. Swanson, R. Patterson, P. J. Lister, and A. N. McDonald. Variation of Winter Road Surface Temperature Due to Topography and Application of Thermal Mapping. *Meteorological Applications*, Vol. 4, 1997, pp. 131–137.
5. Shao, J., P. J. Lister, G. D. Hart, and H. B. Pearson. Thermal Mapping: Reliability and Repeatability. *Vaisala TMI Ltd*, Vaisala House, Bristol Road, Birmingham, U.K.

Characteristics of Materials

CHARACTERISTICS OF MATERIALS

Eutectic Depressants*Relationship of Eutectic, Freezing Point, and Ice Melting Capacity in Liquid Deicers***SCOTT KOEFOD***Cargill, Incorporated*

Work has been done in recent years to try to increase the ice melting performance of liquid deicers by manipulation of the eutectic temperature of the composition. For example, it has been shown that addition of a variety of organic compounds to common liquid deicing chemicals such as magnesium chloride cause a significant decrease in the liquid's freezing point. This has been sometimes interpreted as indicating a lowered eutectic temperature for the composition, which in turn may be expected to result in a lower effective temperature range for deicing. While there have been numerous reports of lowered freezing points measured in these organic-inorganic blended liquids, there has been little ice melting capacity data available. We have undertaken a study to better understand the effect of additives on the eutectic temperature and resulting ice melting capacity of liquid inorganic deicers. Data on organic freeze point depressants in liquid magnesium chloride and potassium carbonate deicing solutions are presented to explore the relationship between freezing points, eutectic temperatures, and ice melting capacity at different temperatures. Data on some experimental formulas indicate that the actual ice melting capacity of a composition can not necessarily be simply predicted based upon the apparent eutectic temperature alone. The data are explained by a consideration of both the thermodynamic factors involved in the chemical deicing process, which are related to the eutectic temperature, together with kinetic factors, which are not accounted for in the strictly thermodynamic measurement of the eutectic.

The eutectic temperature is an important property of any chemical deicer as it determines the lower temperature limit for ice melting. Because the function of a deicer is to lower the freezing point of water, freezing points of liquid deicers and eutectic measurements are frequently used to predict the effectiveness of a given chemical, and attempts have been made to formulate deicers with lower freezing points or eutectics in order to obtain enhanced ice melting performance. However, as important as the eutectic is for the ice melting performance of a deicer, it is not the only important factor, and basing predictions upon the eutectic or freezing temperature alone can lead to misleading predictions. We present a review of the kinetic and thermodynamic factors affecting ice melting capacity of liquid deicers and a study of the relationship between the eutectic temperature, freezing point, and actual ice melting effectiveness of liquid deicing compositions.

RELATIONSHIP OF LIQUID DEICER FREEZING POINT TO ICE MELTING CAPACITY

The eutectic temperature is frequently used as a stand alone indicator of the relative effectiveness of deicing formulations, i.e. "the lower the eutectic temperature, the better the deicer." Similarly,

there have been references suggesting that the freezing point of liquid deicers may be directly related to the ice melting performance, e.g., “the lower the freezing point, the better the deicing liquid.” Considering that freezing point depression is the primary mechanism by which all chemical deicers work, these are not unreasonable initial assumptions. However, examining the underlying chemistry indicates this is an oversimplification.

In order to better understand the relationship between commonly reported performance data and actual ice melting performance, it is helpful to clarify the meaning of some frequently used terms. The freezing point depression that occurs when a deicer dissolves in water is a general phenomenon (called a “colligative property”), and it occurs when anything is dissolved in water. Furthermore, it is observed that the amount of freezing point depression is directly proportional to the concentration of total “colligative particles” (solvated molecules or ions) in solution.

If all chemicals will depress the freezing point of water to the approximately the same extent at a given colligative particle concentration, does this mean that all chemicals will be equally effective deicers? Clearly not. While all solutes will depress the freezing point about the same amount at a given colligative concentration, not all solutes are equally soluble in water—particularly at the cold temperatures at which deicing occurs. Since chemicals must dissolve in water to lower the freezing point and allow chemical deicing to occur, chemicals that are poorly soluble at low temperature will be poorly effective deicers.

This may help clear up a misconception that occurs from time to time—that the optimum concentration of a liquid deicer is the concentration with the lowest freezing point (i.e., the eutectic concentration). This arises from a misunderstanding of the measured freezing points of deicer solutions. Consider Figure 1, which shows the freezing point curve for calcium chloride in water.

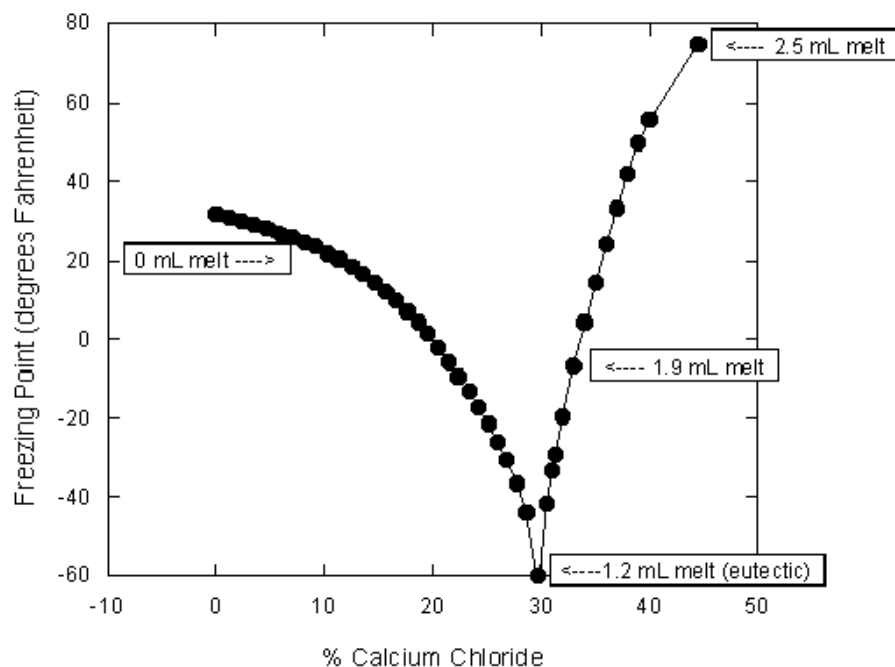

FIGURE 1 Freezing point curve of calcium chloride solution.

Figure 1 shows that as the concentration of calcium chloride increases, the freezing point of the solution steadily drops until it reaches a minimum at a concentration of 30% calcium chloride and a freezing point of -60°F (-51°C). This minimum freezing point composition is the eutectic for the mixture of calcium chloride and water. As the concentration of calcium chloride rises above the eutectic value, the freezing point of the solution begins to increase again, giving rise to the characteristic V-shaped freezing point curve often seen. However, proper interpretation of this curve requires an understanding of how freezing point is defined. The freezing point for the solution is considered to be the temperature at which solid first begins to form in solution, but the solid formed is different depending on which side of the eutectic the system is on. At concentrations below the eutectic true freezing of water of water occurs at the freezing point. At concentrations higher than the eutectic, on the other hand, the freezing is not due to the formation of ice. Rather, solid calcium chloride hexahydrate crystallizes from solution because its solubility has been exceeded at that temperature.

Thus, there is no advantage from an ice melting capacity standpoint to diluting a deicer solution to its eutectic concentration. Other researchers have also noted this. Yatsenko and Chudotvortsev noted that the ice melting rate from solutions of lithium, sodium, and potassium chloride increased with the concentration of the salt (though the rate of increase varied significantly between different salts) (1). There might be other reasons one would want to use a less than saturated solution of chemical (e.g., practical availability or the potential for crystallization of excess chemical in storage tanks at cold temperatures), but from the standpoint of ice melting capacity it will always be most advantageous to use the highest concentration of chemical possible. More chemical will melt more ice. For example, if a solution of magnesium chloride that is saturated at room temperature is placed on ice at a temperature of 0°F (-18°C) the solubility of magnesium chloride will drop from 35% to about 28% and the excess solid magnesium chloride will crystallize on the ice. However, the solid magnesium chloride remains an effective deicing chemical and will continue to melt ice, provided the temperature is above its practical working temperature.

Ice melting measurements were made to confirm this for calcium chloride solutions. Figure 1 shows ice melting capacities measured on calcium chloride solutions of different concentrations. Ice melting capacities were measured by following the SHRP H205.2 protocol (2). Ice melting capacities noted in Figure 1 are milliliters of melt per gram of deicer liquid. The data in Figure 1 show that the ice melting capacity of calcium chloride solution increases as the concentration increases. It can be seen from Figure 1 that the ice melting capacity of calcium chloride liquid does not correlate with the liquid's freezing point. Thus, a highly concentrated calcium chloride has a high freezing point because excess calcium chloride will crystallize out of solution as the temperature drops, but this solid calcium chloride still provides effective ice melting action.

LIQUID FREEZE POINT DEPRESSANTS AND RELATION TO ICE MELTING CAPACITY

Work has been done over the past 10 years to try to increase the ice melting performance of inorganic salt liquid deicers by manipulation of the eutectic temperature or the freezing point. For example, it has been shown that addition of various organic materials to aqueous solutions of common deicing chemicals such as magnesium chloride causes an apparent decrease in the

liquid's freezing point. This has been sometimes interpreted as indicating a lowered eutectic temperature for the composition, which in turn is thought to result in a lower effective temperature range for deicing. While there have been numerous reports of lowered freezing points measured in these organic–inorganic blended liquids, there has been little ice melting capacity data available. We have undertaken a study to better understand the effect of organic additives on the eutectic temperature and resulting ice melting capacity of liquid inorganic salt deicers.

Agricultural byproducts are commonly used freezing point depressants for inorganic deicing liquids. Thus, we looked at mixtures of a highly water-soluble agricultural byproduct with an inorganic salt deicing liquid. Two different inorganic salts were studied. A commonly used deicing salt, magnesium chloride, was studied in one set of experiments, and potassium carbonate in another set. Potassium carbonate was chosen to provide a nonchloride salt example that was still an inorganic salt deicer. In one series of tests potassium carbonate liquid was blended with a highly water-soluble liquid agricultural byproduct. In a second series of tests magnesium chloride liquid was blended with a solution of xylitol. Xylitol was chosen as an experimental organic freezing point depressant because it is a sugar alcohol and chemically similar to the carbohydrates that have been used as freezing point depressants in some commercial formulas.

A 52% solution of potassium carbonate (K_2CO_3) was used as the base deicing liquid (it has a similar ice melting effectiveness to a 30% magnesium chloride liquid), and it was mixed with 10%, 25%, or 50% of the agricultural byproduct by mass. The agricultural byproduct was a liquid containing 50% dissolved solids. The freezing points of the mixtures were measured according to the ASTM D1177 protocol (3) and ice melting capacities measured according to SHRP H205.2 (2). The results are summarized in Table 1. Densities of the liquid formulas were measured at each temperature. Ice melting capacities were measured as milliliters of melt per gram of deicer and converted to units of grams of ice melted per gram of applied liquid deicer as described in SHRP H205.2. Ice melting capacities were measured on four replicates for each formula and the sample standard deviations are reported parenthetically. Negative values of ice melting capacity indicate refreeze of the applied liquid and no net ice melting.

Liquid deicer bid specifications commonly require a chart showing the freezing point measured over a range of concentrations. The standard test method invoked for this is ASTM D1177, Standard Test Method for Freezing Point of Aqueous Engine Coolants (3). This method involves exposing the sample to a cold temperature bath and measuring the change in sample temperature over time. An ideally behaved liquid will steadily decrease in temperature as heat is lost until the onset of freezing, at which point the temperature drop stops and forms a plateau throughout the remainder of the freezing. The freezing point is determined graphically from the curve as the temperature at which this plateau begins.

TABLE 1 Ice Melting Capacity of K_2CO_3 Mixtures Measured After 60 min

% Agricultural Liquid	Freezing Point, °F (°C) (3)	Ice Melt Capacity, 15°F	Ice Melt Capacity, 5°F (g/g)
0	19 (−7.2)	0.87 g/g (0.02)	0.43 g/g (0.04)
10	6.4 (−14.2)	0.58 g/g (0.09)	0.18 g/g (0.06)
25	−35 (−37)	0.25 g/g (0.13)	−0.06 g/g (0.06)
50	−27 (−33)	−0.21 g/g (0.09)	Not measured

However, it is important to recognize that as mixtures become more complex the freezing point will often become less well defined. Pure compounds will often have well defined freezing points, but the phase changes in multicomponent mixtures can be more complex. This appears to be the case in the mixtures of inorganic salt liquids and organic freeze point depressants we examined. [Figure 2](#) shows the cooling curve measured for liquid potassium carbonate with no agricultural additive. The solution of pure potassium carbonate gave a well-behaved cooling curve; there is a clear break when the freezing plateau begins. Compare this to [Figure 3](#), which shows the cooling curve obtained when 25% agricultural additive is blended with the potassium carbonate liquid. The clean transition between the cooling portion of the curve and the freezing plateau is much less clear. The same effect was observed on mixtures of xylitol with magnesium chloride liquid. This points to disadvantages in using ASTM D1177 for measuring freezing points in complex mixtures. For reasons discussed below, mixtures of organic compounds with inorganic freeze point depressants often have poorly defined phase transitions, making determination of freezing points from simple cooling curves imprecise.

Nevertheless, since freezing points measured by this method are commonly reported performance data for liquid deicers, it is interesting to compare the measured freezing points to actual ice melting capacities. It can be seen from the data in [Table 1](#) that the decrease in freezing point caused by addition of the agricultural byproduct does not result in increased ice melting effectiveness. Indeed, the agricultural additive inhibited the ice melting of the blend. The highest ice melting capacity was observed in the base solution of 52% potassium carbonate. As this base

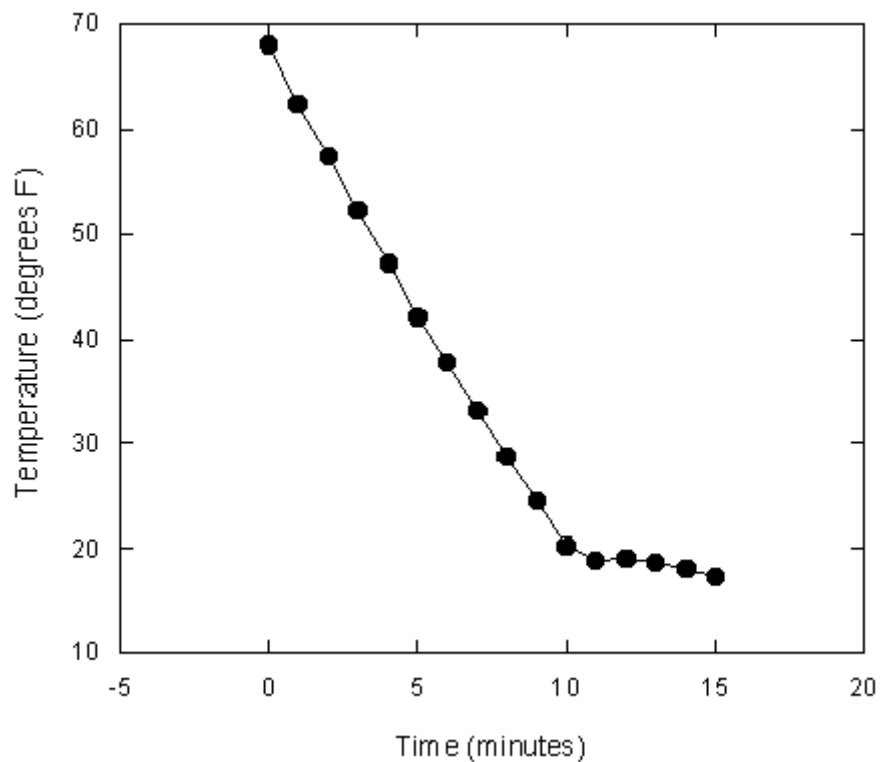

FIGURE 2 Cooling curve measured on pure potassium carbonate liquid by ASTM D1177.

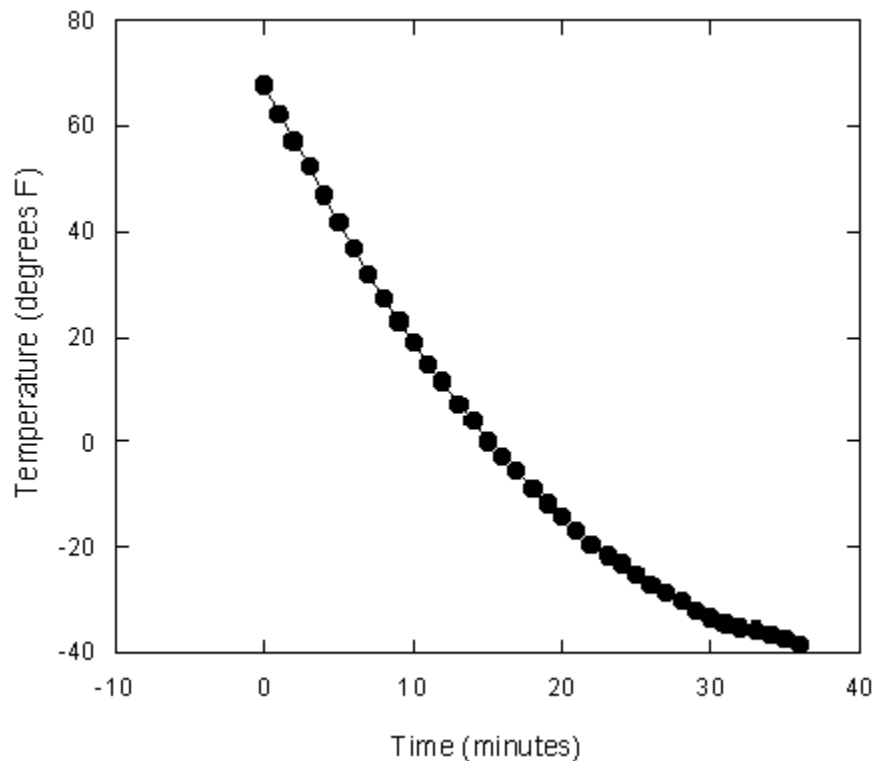

FIGURE 3 Cooling curve measured on potassium carbonate liquid blended with 25% agricultural liquid by ASTM D1177.

liquid was blended with progressively higher levels of the agricultural additive, the freezing point of the blend dropped. Addition of 25% agricultural additive caused a freezing point that was 54°F (30°C) lower than the plain potassium carbonate liquid. However, the ice melting capacity measured at 15°F (−9.4°C) was about 70% lower than for the base potassium carbonate liquid with no agricultural additive. It can also be seen that the lower freezing point of the agricultural blend did not cause better ice melting at colder temperatures. At a temperature of 5°F (−15°C), the 25% agricultural blend formulation gave no net ice melting at all, whereas the plain potassium carbonate liquid still gave significant ice melting.

To gain more information we examined another system, this time looking at mixtures of magnesium chloride (MgCl₂) solution as the base inorganic deicing liquid with a pure organic compound as an experimental freeze point depressant. Xylitol, a 5-carbon sugar alcohol with a high solubility in water was chosen as the freeze point depressant. Freezing points and ice melting capacities were measured on mixtures of the base inorganic deicer liquid (31.2% magnesium chloride in water) with a solution of 60.0% xylitol by the same methods described above. Results are summarized in Table 2.

The data in Table 2 show the same behavior that was observed in mixtures of potassium carbonate solution with agricultural byproduct. Addition of xylitol to liquid magnesium chloride causes an apparent decrease in the freezing point. The first four formulas listed in Table 2 show measurements on the base magnesium chloride solution blended with 0%, 25%, 50%, and 75% xylitol solution, respectively (i.e., a blend of 25% of xylitol solution which in turn is 60% xylitol

TABLE 2 Ice Melting Capacity of MgCl₂ Mixtures Measured After 60 min

% Xylitol	% MgCl₂	Freezing Point °F (°C) (3)	Ice Melt Capacity 15°F
0	31.2	3 (-16)	1.22 g/g (0.11)
15.0	23.4	-27 (-33)	0.76 g/g (0.14)
30.0	15.6	-35 (-37)	0.39 g/g (0.07)
45.0	7.8	Not determined	0.08 g/g (0.06)
60.0	0	Not determined	0.02 g/g (0.10)

by mass results in a final formula that contains 15.0% xylitol). A blend of 50% magnesium chloride liquid with 50% xylitol solution (30.0% xylitol and 15.6% MgCl₂ by mass) shows an apparent freezing point that is about 38°F (21°C) lower than that of the base magnesium chloride solution. However, as was seen with the potassium carbonate formulas, this lower apparent freezing point does not result in a higher ice melting capacity. The final entry in Table 2 shows the ice melting capacity for the 60% xylitol solution. While the xylitol solution causes an apparent decrease in freezing point when mixed with liquid magnesium chloride deicer, it can be seen to have essentially no ice melting capacity of its own at 15°F (-9.4°C). It is interesting to compare the ice melting capacity of the mixtures to their magnesium chloride content. This is illustrated in Figure 4. Despite of the apparent effect of xylitol on the freezing point of the mixtures, the ice melting capacity varies approximately directly with the concentration of the primary deicing chemical—magnesium chloride.

PHASE BEHAVIOR OF RELATED SYSTEMS

There have been few published studies of the detailed physical chemistry of chemical ice melting. However, the behavior of aqueous sodium chloride solutions and the effects of organic additives known as “cryoprotectants” have been well studied and may provide some insight about the effect of organic freeze point depressants in liquid inorganic deicers. Cryoprotectants are chemicals that inhibit the formation of ice crystals. They occur in some biological systems, for example helping to protect certain plants from freeze damage. They also find practical applications in protecting some food products from freeze damage. A variety of cryoprotectant chemicals are known. They are often sugars and related low molecular weight carbohydrates such as sucrose, glucose, lactose, trehalose, mannitol, and sorbitol (4–6). Other cryoprotectants include dimethyl sulfoxide, higher molecular weight polymers such as dextran and polyvinylpyrrolidone (4,5), and the amino acid proline (7).

In general, cryoprotectants appear to work by causing a kinetic inhibition of ice crystallization. This is clearly seen in the phase behavior of sucrose solutions. Rather than giving a well-defined freezing point when cooled, sucrose solutions tend to exhibit a steadily increasing viscosity. This arises from the formation of an amorphous, glassy, metastable phase, which is characterized by a glass transition temperature rather than a freezing point. This appears to be caused by the ability of the sucrose (and carbohydrates in general) to form strong hydrogen bonded networks with water (8). Carbohydrates also affect the freezing behavior of salt brines. Differential scanning calorimetry (DSC) provides a more precise measurement of phase changes than is possible with cooling curves. A variety of DSC studies on the effects of carbohydrate

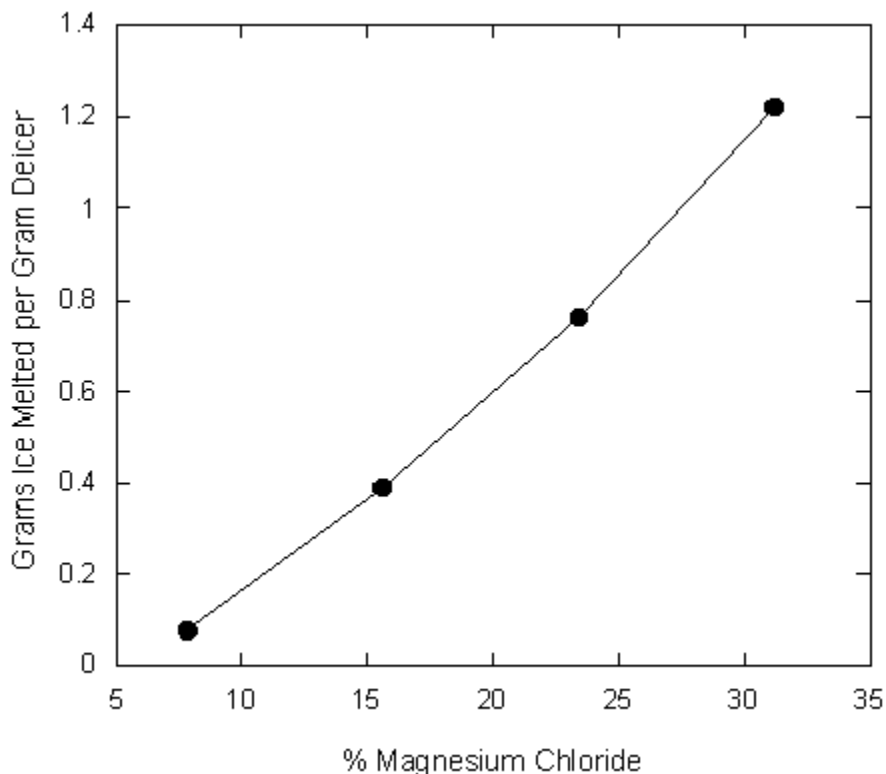

FIGURE 4 Ice melting capacities of magnesium chloride solutions blended with different amounts of 60% xylitol solution.

additives on sodium chloride brines have been published. Plain sodium chloride brines show two distinct phase changes upon cooling. As the brine is cooled it undergoes first a predominant freezing process as water freezes and then at colder temperature a second freezing event is observed that is associated with a pseudo-eutectic formation. When the completely frozen brine is warmed again, two separate melting events are observed: the melting of the eutectic (which includes crystalline sodium chloride dihydrate) followed by melting of pure ice at warmer temperature (9).

Addition of a variety of carbohydrates has been shown to have a similar effect on the phase changes in sodium chloride brines. As the concentration of carbohydrate in the brine increases, the temperature of the eutectic freezing shifts to colder temperature and the amount of eutectic formed steadily decreases, until eutectic formation is completely suppressed. The mechanism of eutectic suppression is under investigation, but it is generally believed to be a kinetic effect, caused by trapping of sodium chloride in an amorphous glass, reducing the mobility it needs to assemble the eutectic (5–6). DSC studies also show the effect of sugars on the freezing temperature of water (as distinct from the eutectic formation temperature). In the absence of sugar, the freezing point depression of water increases as sodium chloride concentration increases, as expected. In the presence of sugars, the behavior is more complex. In solutions with a given concentration of sugar, the freezing point depression is greater at low sodium chloride concentrations than solutions of the same concentration sodium chloride with no sugar, as would be expected due to colligative contribution from the sugar. However, at higher sodium chloride concentrations the freezing point depression of the liquid is actually less than

that of the same concentration sodium chloride solution with no sugar. This suggests that an associative interaction occurs between sugar and sodium chloride at higher concentrations and is consistent with other work that has shown that there can be strong interactions between sugar and electrolyte in solution (6).

The studies of cryoprotectant effects on sodium chloride brines may have important implications for the utility of organic freeze point depressants in inorganic salt deicing liquids. Cryoprotectants such as carbohydrates have been shown to decrease the eutectic temperature of sodium chloride brines, but it is important to note that this seems to be a kinetic effect rather than a thermodynamic effect. That is, there is not a true decrease in the thermodynamically stable eutectic temperature; the apparent decrease occurs because the kinetics of eutectic formation have been slowed so much the system cannot keep up with the temperature change; it is “supercooled.” The cryoprotectants do not cause a true decrease in the freezing point of water (except insofar as they do so by increasing the colligative concentration of solution); they simply restrict the mobility of water molecules, slowing ice crystal growth, and masking the true freezing transition with formation of a metastable, glassy state. This explains why we were not observing increased ice melting capacity by addition of organic additives to our inorganic deicer liquids. The decreased freezing point caused by the organic additives is not primarily a colligative effect and thus would not be expected to increase colligative ice melting.

MEASURING EFFECT OF ORGANIC FREEZE POINT DEPRESSANTS BY ADIABATIC CALORIMETRY

Since freezing points measured by cooling curve (such as in ASTM D1177) in systems that are subject to formation of metastable, amorphous phases often do not reflect the true, thermodynamically stable colligative properties of the liquid, they can be misleading predictors of ice melting capacity. For the purposes of predicting ice melting capacity, it is more appropriate to directly measure the colligative capacity of the deicer. The colligative capacity of a chemical can be measured in a variety of ways, such as vapor pressure or freezing point osmometry. We measured the effect of organic additives on the colligative properties of a deicing liquid by doing a simple adiabatic calorimetry experiment. A known mass of deicing liquid was introduced to the calorimeter and dissolved in a known mass of water. Excess ice was then introduced to the calorimeter and mixed while monitoring the temperature. As ice melting occurs, the temperature of the mixture drops steadily (due to the endothermic enthalpy of ice fusion) until the system reaches equilibrium at which point the ice melting stops, and the temperature levels off and holds constant. The difference between the final equilibrium temperature of the mixture and the freezing point of pure water is taken as the freezing point depression, ΔT . By using the simple molal freezing point depression relationship, $\Delta T = K_f m$ (where K_f is the molal freezing point depression constant for water, $1.86^\circ\text{C kg/mole}$) the colligative molality of the solution, m , in moles of solute particles per kilogram of solvent may be determined.

Measurements were made on mixtures of potassium carbonate liquid deicer blended with 0%, 10%, 25%, and 50% by mass agricultural liquid additive. For each blend, measurements were made using three different concentrations of chemical in the calorimeter; two or three replicates were done for each test concentration, giving a total of 6 to 8 data points for each formula tested. The colligative molality was calculated for each test run, and because the total

mass of water was known in each run, it was possible to calculate the moles of colligative particles available per mass of chemical deicer (dry solids basis). Plots of the moles of colligative particles available per gram of chemical were linear (the square of the correlation coefficient, R^2 , was greater than 0.991 for every formula except for the 25% agricultural additive formula, which gave an $R^2 = 0.96$). The linearity indicates that there were not significant differences in solute particle association over the concentration ranges tested. Thus, these plots provide values of moles of colligative particles per gram of chemical mass that can be compared for different blends of agricultural additive with potassium carbonate. Values calculated for each formula are given in Table 3.

At infinite dilution potassium carbonate is expected to produce 0.0217 moles of particles per gram. However, ionic compounds typically yield fewer colligative particles per mole than would be predicted because of ion pairing. Potassium carbonate has been shown to form ion pairs in higher concentration solutions (10). Figure 5 shows how the quantity of colligative particles available varies with the amount of agricultural additive in the blend. It can be clearly seen that blending the potassium carbonate liquid with increasing amounts of agricultural additive progressively reduces the number of colligative particles available.

It is further interesting to note that the number of colligative particles available decreases very linearly as the potassium carbonate is diluted ($R^2 = 0.997$). This indicates that the agricultural additive is not increasing the colligative potential of the deicer blend at all and in this case the colligative concentration of the liquid depends simply upon the concentration of the inorganic salt present. Ideally, one would expect that the soluble components of the agricultural additive would contribute to the overall concentration of colligative particles in the liquid deicer. The observation that it does not may indicate that there is an associative interaction between the agricultural additive and the inorganic salt that reduces the number of colligative particles available. This may be consistent with similar observations of associative interactions between carbohydrates and electrolytes in solution (6).

The measurement of available colligative particles provides a much more accurate predictor of ice melting potential than freezing points measured by ASTM D1177. Figure 6 shows a plot of ice melting capacities of the potassium carbonate liquid blends (measured after 60 min) with agricultural additive as a function of the moles of colligative particles available per gram of dry deicer chemical mass. Ice melting capacities are from the formulas listed in Table 3. Each liquid formula contains the same concentration of dry chemical ($52\% \pm 1\%$); thus, the formulas differ only in the number of colligative particles available per gram of dry chemical content. Figure 6 shows that there is a linear relationship ($R^2 = 0.994$) between the ice melting capacity of the different formulas and their colligative particle content. Thus, measurement of the colligative particles available per gram of chemical may be a better predictor if ice melting

TABLE 3 Moles of Colligative Particles per Gram of Dry Chemical Mass for Mixtures of Potassium Carbonate and Agricultural Additive

% Potassium Carbonate	% Agricultural Additive	Moles Particles per Gram
52	0	0.015
47	5	0.013
39	13	0.011
26	25	0.0065

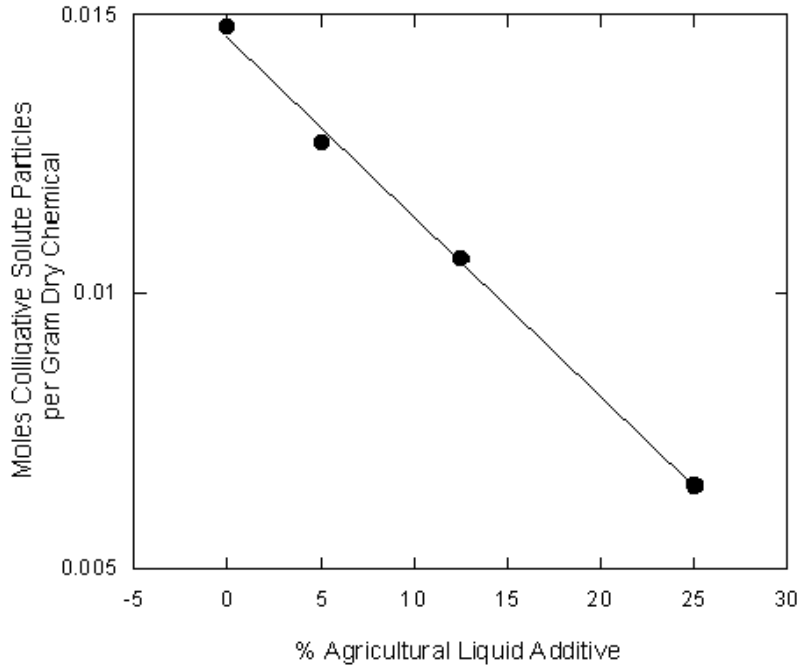

FIGURE 5 Effect of agricultural byproduct addition to potassium carbonate liquid deicer on colligative particles available.

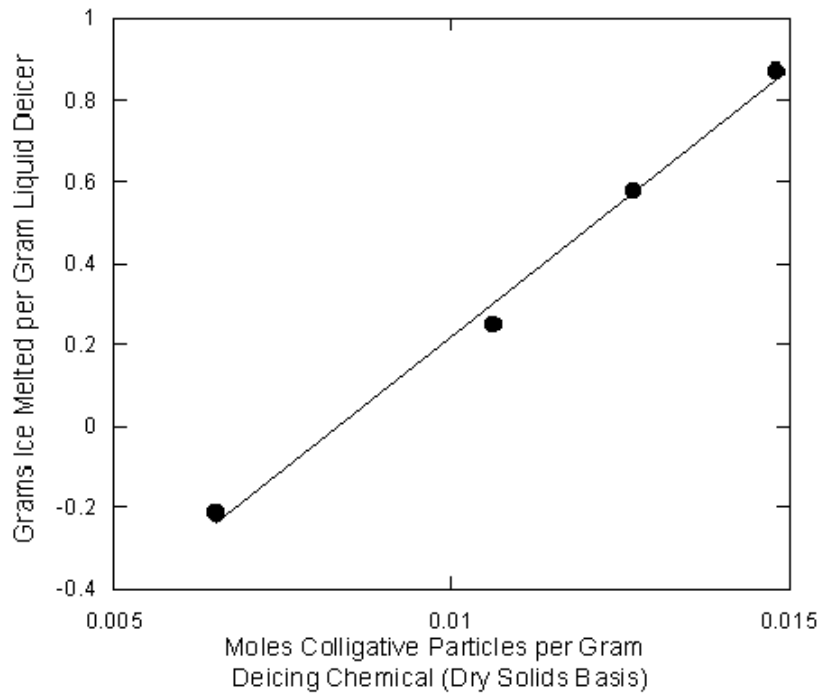

FIGURE 6 Relationship between ice melting capacity and quantity of colligative particles available in blends of liquid potassium carbonate and agricultural additive at 15°F (-9.4°C).

capacity than freezing point or eutectic temperature of a liquid. As discussed above, there is no simple correlation between the freezing point of a deicing liquid and its ice melting capacity.

CONCLUSIONS

Two systems (aqueous magnesium chloride plus xylitol and aqueous potassium carbonate plus a soluble liquid agricultural byproduct) were evaluated to determine if organic freezing point depressants could increase the ice melting capacity of inorganic salt deicing liquids. In both cases the organic additives were observed to lower the freezing points of the inorganic deicer solutions as measured by ASTM D1177. However, as the inorganic deicing liquid was diluted with organic additive, the ice melting capacities of the blends steadily decreased. The apparent decrease in freezing points of the liquids may be due to the formation of metastable, amorphous phases which do not have well defined freezing points, by analogy to the known effect of organic cryoprotectants on sodium chloride brines. This is consistent with the disappearance of a well defined freezing plateau in the cooling curves measured on the liquids with organic additives. An improved measurement of the effect of organic additives on the deicing ability of inorganic salts was made by using adiabatic calorimetry to determine the quantity of colligative particles available per gram of chemical deicer. Ice melting capacity of formulas containing potassium carbonate and agricultural additive correlated strongly with the moles of colligative particles available per gram deicer. The agricultural additive in our tests did not cause any significant increase in the colligative particles available in blends with potassium carbonate, explaining why the ice melting capacity decreased as the concentration of agricultural additive increased.

REFERENCES

1. Yatsenko, O. B., and Chudotvortsev. Ice Melting and Crystallization in Binary Water–Salt Systems. *Inorganic Materials*, Vol. 38, No. 9, 2002, pp. 907–913.
2. Chappelow, C. C., R. R. Blackburn, D. Darwin, F. G. de Noyelles, and C. E. Locke. *Handbook of Test Methods for Evaluating Chemical Deicers*. SHRP, National Research Council, Washington, D.C., 1992.
3. Standard Test Method for Freezing Point of Aqueous Engine Coolants (ASTM D 1177-94). *1994 Annual Book of ASTM Standards*, American Society for Testing and Materials, Philadelphia, Pa., 1994.
4. Her, L., M. Deras, and S. L. Nail. Electrolyte-Induced Changes in Glass Transition Temperatures of Freeze-Concentrated Solutes. *Pharmaceutical Research*, Vol. 12, No. 5, 1995, pp. 768–772.
5. Chen, N., J. Morikawa, and T. Hashimoto. Effect of Cryoprotectants on Eutectics of NaCl·2H₂O/Ice and KCl/Ice Studied by Temperature Wave Analysis and Differential Scanning Calorimetry. *Thermochimica Acta*, Vol. 431, 2005, pp. 106–112.
6. Ogawa, S., and S. Osanai. Inhibition Effect of Sugar-Based Amphiphiles on Eutectic Formation in the Freezing–Thawing Process of Aqueous NaCl Solution. *Cryobiology*, Vol. 54, 2007, pp. 173–180.
7. Rasmussen, P. H., B. Jorgenson, and J. Nielsen. Aqueous Solutions of Proline and NaCl Studied by Differential Scanning Calorimetry at Subzero Temperatures. *Thermochimica Acta*, Vol. 303, 1997, pp. 23–30.
8. Schawe, J. K. E. A Quantitative DSC Analysis of the Metastable Phase Behavior of the Sucrose-Water System. *Thermochimica Acta*, Vol. 451, 2006, pp. 115–125.
9. Huidt, A., and K. Borch. NaCl-H₂O Systems at Temperatures Below 273 K, Studied by Differential Scanning Calorimetry. *Thermochimica Acta*, Vol. 175, 1991, pp. 53–58.
10. Lee, H., and J. K. Wilmhurst. Observation of Ion Pairs in Aqueous Solutions by Vibrational Spectroscopy. *Australian Journal of Chemistry*, Vol. 17, No. 8, 1964, pp. 943–945.

CHARACTERISTICS OF MATERIALS

The Amount of Salt on Road Surfaces After Salt Application

A Discussion of Mechanisms and Parameters

KAI RUNE LYSBAKKEN

HARALD NOREM

Norwegian University of Science and Technology

Field observations have been made to study the development of salt amount on road surfaces after salt application. The objective of the study has been to understand the mechanisms that remove salt from road surfaces after spreading and identify important parameters behind the mechanisms. After salt application salt is transported from the road surface by the three mechanisms: blowoff, spray-off, and runoff. The mechanisms are affected by several parameters grouped in weather parameters, traffic parameters, and road characteristics. Four case studies are presented where the amount of salt was measured with SOBO 20. Weather, traffic, and winter maintenance activities were recorded. The amount of water on road surface was measured by using absorbent textiles. The results show that the amount of water on the road surface controls the development of salt amount on road surface. Both the mechanisms of salt loss and how much salt becomes dissolved are governed by the amount of water on the road surface. On a wet road surface more salt will be dissolved compare to a moist road surface. This lead to a higher peak value in the amount of dissolved salt which is detected with the used instrument. Further, on a wet road surface there will be a more rapid loss of salt due to a higher effect of spray-off.

Important aims for winter maintenance of roads are to achieve a high level of accessibility, regularity, and traffic safety during the wintertime. Securing a sufficient level of is essential to achieve these aims. Snow and ice removal and friction control are therefore the most important activities in winter maintenance of roads. Mechanical and chemical methods are used both for snow and ice removal and for friction control.

Independent of the purpose of a salting action, whether it is to prevent freezing (anti-icing), to melt ice or snow (deicing), or to prevent the build-up of compacted snow on road surfaces (anticompaction and antiadhesion), there are several critical factors that determine the effectiveness of the application. The most critical factors are timing and spreading rate of the application. The amount of salt on the road surface is critical for the road surface conditions and whether or not ice formation or snow compaction occurs. How long the salt remains on the road surface after application is therefore vital for the road surface conditions. Knowledge of the development of the amount of salt after a salt application is relevant for

- Decision making,
- Establishing guidelines, and
- Research and development activities.

The person making the decision of when to salt and how much to spread benefits from having insight into how much and how long salt remains on the road surface. At higher

organizational levels it can be useful knowledge in the work of optimizing the use of salt-using guidelines for application. The knowledge can, for example, be used further to assess spreading methods under different surface conditions.

There have been several studies on the development of salt amount on road surfaces. Blomqvist and Gustafsson (1) studied the distribution of salt in the cross-section of the road and developed a model for development of the salt amount as a function of traffic. Hunt, Mitchell, and Richardson (2) studied the development of salt amount after brine application. Glue (3) investigated also the development after brine application. These studies, however, did not consider the amount of water that is present on the road surface.

This work describes a field study on how the amount of salt on road surfaces develops after a salting application. The objective is to understand the mechanisms that remove the salt from road surfaces and identify the important parameters behind these mechanisms. Issues concerning the actual spreading of salt are not addressed in this work. Questions like the efficiency of different spreading methods are not concerned.

MECHANISMS THAT CONTROL THE AMOUNT OF SALT ON ROAD SURFACES

There are several parameters that influence the amount of salt on road surfaces. To understand further how the amount of salt develops after salting actions, it is useful to identify the mechanisms that remove salt from the road surface. Considering the road surface as a system, movements of salt out of the system can be observed. Assuming that salt is evenly distributed in a longitudinal direction, the flow of salt in and out of the system can be seen in a two-dimensional, cross-section profile of the road.

Three removal mechanisms can be identified: (a) blowoff, (b) spray-off, and (c) runoff. These mechanisms are illustrated in Figure 1 (also Table 1).

Blowoff

The mechanism of blowoff is the removal of solid salt grains from the road. Blowoff is caused by traffic and thus depends on the number of vehicles, type of vehicles, and traffic speed. In

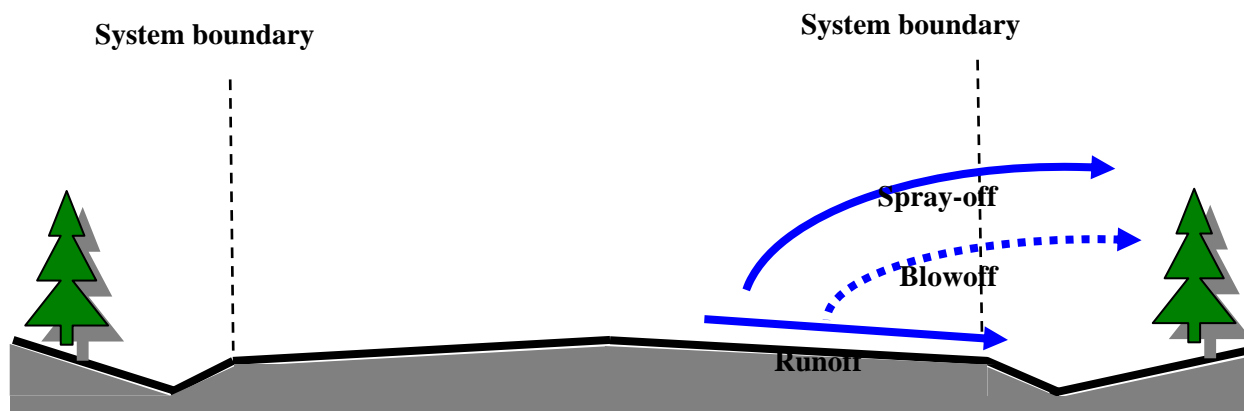

FIGURE 1 Cross profile of a road with the salt loss mechanisms illustrated.

TABLE 1 Mechanisms That Remove Salt from a Road Surface and Parameters Affecting the Mechanisms

Mechanism	Weather	Traffic	Road Characteristics
Blowoff	Wind Amount of water on road surface— precipitation	Amount Speed Vehicle type	Texture
Spray-off	Wind Amount of water on road surface— precipitation	Amount Speed Vehicle type	Texture Rutting
Runoff	Amount of water on road surface— precipitation		Texture Rutting Cross-fall

addition, wind will probably increase blowoff. Blowoff will also be affected by the road surface conditions such as how wet the road is and if snow, ice, or slush is present. Pavement texture will probably also influence blowoff. A coarse texture may hold onto the grains to a greater extent than a fine texture.

Spray-Off

Spray-off is dissolved salt that is sprayed off the road surface. Spray-off is caused directly by traffic and thus depends on number of vehicles, type, and speed. Similarly for spray-off, other parameters may also affect the mechanism. A wet road surface will give more spray-off than a dry or moist one. Wind will increase the spray-off effect. A coarse texture on pavement was found to give less spray-off (4).

Runoff

Runoff is the gravity-driven drainage of liquid from the road. Runoff probably will onset when there is a critical amount of water that has been collected on the road surface. The system of pores in the pavement will have to be saturated before runoff occurs. When the amount of water on the road surface has reached this critical value, runoff will take place. This can be seen as a threshold value. Both the threshold value and the flux will depend on the road surface texture, cross-fall, and rutting.

Redistribution in the Cross-Section Profile

Salt is redistributed within the system. Redistribution is not a removal mechanism but it can change salt distribution within the boundaries. A normal part of redistribution is that salt is transported from the wheel tracks to the area between wheel tracks and the shoulder and thereby results in less salt in wheel tracks (1).

Table 1 summarizes the loss mechanisms and the important parameters that control each loss mechanism. As stated earlier, for blowoff and spray-off, traffic is the driving force for the

mechanisms. Blowoff and spray-off are in that respect a function of traffic. The driving force of runoff is gravity rather than time. Since runoff becomes significant only after a critical amount of water, it seems natural in most cases to plot salt amount as a function of traffic.

FIELD STUDIES

Field observations were carried out on plowing–salting route on the E6 south of Trondheim, Norway. The strategy for the maintenance standard requires that the road surface shall be free of snow and ice, except during snowfall. After snowfall the road shall be free of snow and ice within 4 h after the snowfall ended. The selected strategy for winter maintenance requires that chemical methods are used for friction control and chemical methods along with plowing are used after snow removal. On this route salt is spread mostly as prewetted salt (prewetted with 30% water) or as dry salt.

The road is a typical two-lane road with an average annual daily traffic (AADT) of approximately 5,000. A certain point on the road was chosen for data collection. Figure 2 shows the road and the location for field observation. Regular observations were conducted during the winter seasons of 2005–2006 and 2006–2007. Each observation period is considered as an individual case.

The basic method for the field studies was to document the road surface conditions and collect data in connection with ordinary maintenance measures and salting action on this section of the road.

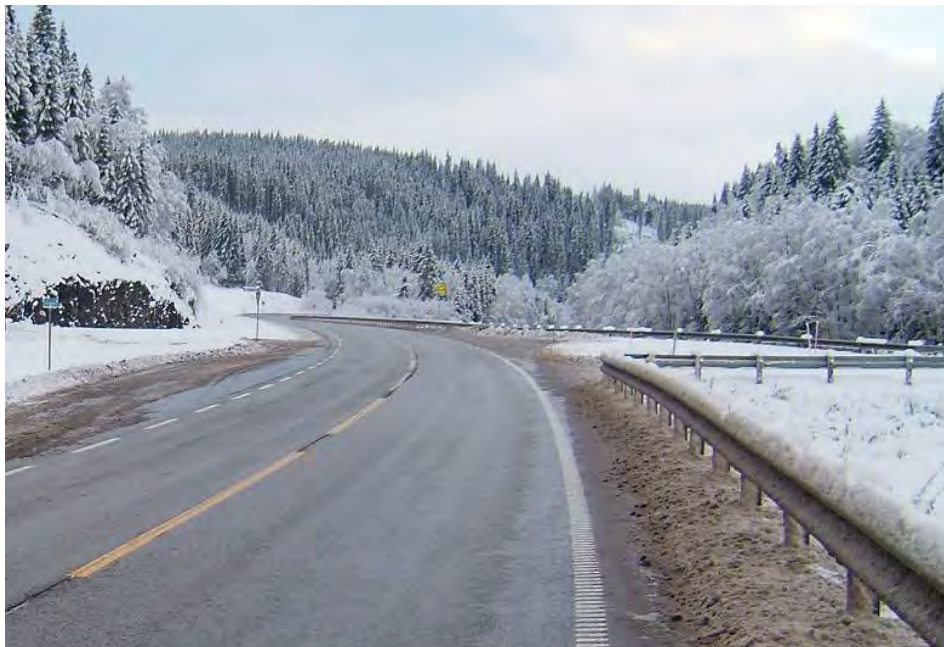

FIGURE 2 The site and the road chosen for field studies.

Data Collection

The collection of data included both automatic and manual data collection. The parameters relevant for this analysis are

- Automatic data
 - Data from maintenance trucks and
 - Traffic data
- Manual data
 - Weather parameters,
 - Water on road surface, and
 - Salt amount.

The maintenance trucks had a system based on the Global Positioning System and the Global System for Mobile communications for logging maintenance measures. This system logs when and what type of maintenance measures that are being conducted. This includes the spreading rate and snow removal. The traffic data includes number of cars and number of heavy vehicles every hour.

Air and road temperature, dew point, and precipitation as well as salt amount and amount of water on road surface were measured. The measuring techniques are presented in chapters on measuring salt amount with SOBO 20 and measuring road surface water with Wetex. Road surface conditions were documented by taking photographs and qualitative descriptions.

Measuring Salt Amount with SOBO 20

Salt amount was measured by using the instrument SOBO 20 (Figure 3a).

The instrument has a mouthpiece that is placed on the road surface. This mouthpiece has a rubber gasket which encloses a known area. When pressing the instrument against the surface,



(a)



(b)

FIGURE 3 Measuring (a) salt amount with SOBO 20 and (b) water amount with Wetex textile.

a known amount of measuring fluid is sprayed on to the road surface. The measuring fluid is a mixture of acetone and water. The instrument measures the electric conductivity in the measuring fluid. By having a defined area of measurement, a known amount of measuring fluid, and the electric conductivity the instrument calculates the amount of salt on the road surface in g/m^2 . A more thorough description of SOBO 20 is found in Nygaard (5).

During the field observations salt amount were measured in the right-wheel track and between wheel tracks. Each time three repetitions in the longitudinal direction were made and the average from these three readings was calculated.

Measuring Road Surface Water with Wetex

The amount of liquid was measured by using a absorbent textile called Wetex (Figure 3b). By placing a textile piece of known dimensions (0.265×0.410 m) on the road surface it will absorb the present liquid. The amount of liquid per unit area was determined by weighing the textile before and after the absorption. It was recognized that this was not a very precise and flawless method because it is never possible to absorb all the water. However, it is simple, rapid, and provides relative data on how wet a road surface is. Measurements were taken in right-wheel tracks and between wheel tracks.

For data presentation and analyses, the following classification of wetness for road surfaces has been used (Table 2).

RESULTS FROM FIELD STUDY

Case 1: 2007.01.24 (Observation Period: January 24, 2007, from 04:00 to 18:00)

The weather was lightly clouded and with air temperature at 04:00 on -12.4°C and road surface temperature of -13.6°C . During the observation period they increased to -7.7°C and -7.2°C , respectively. In the wheel tracks the surface had scattered ice crystals, but not to the extent where the road surface became slippery. The roads were salted at 06:30 with $30 \text{ g}/\text{m}^2$ of prewetted salt. After salting and rising temperatures the road surface in wheel tracks became moist. Between wheel tracks there was some loose snow that became slush during observation time (Figures 4 and 5).

Case 2a: 2007.01.31—Southbound Lane (Observation Period: January 31, 2007, from 04:00 to 14:00)

There was a light cloud cover with some precipitation in the form of sleet and snow around the

TABLE 2 Definition of Moist and Wet Road Surface

Road Surface Wetness	Amount of Water (g/m^2)	Equivalent Water Film Thickness (mm)
Dry	0	0
Moist	0–100	0–0.1
Wet	>100	>0.1



(a)



(b)

FIGURE 4 The observation point at (a) 07:56 and (b) 09:20.

time of the salting action. Maximum and minimum air temperatures were $+2.1^{\circ}\text{C}$ and $+0.2^{\circ}\text{C}$, respectively. Road temperature was a maximum of $+0.8^{\circ}\text{C}$ and a minimum of -0.1°C . The road surface was wet, and there was some slush between the wheel tracks. Salt application in the south bound lane took place at 06:38 with 30 g/m^2 of prewetted salt (Figures 6 and 7).

Case 2b: 2007.01.31—Northbound Lane

This shows the same time and condition as Case 2a, except that the data is collected in the northbound lane. Here, the salting took place at 07:13. The application rate was 30 g/m^2 of prewetted salt (Figure 8).

Case 3: 2007.02.27 (Observation Period: 27 February 2007, from 09:00 to 17:30)

The weather was cloudy with rising temperatures. The air temperature was a minimum of -2.1°C and of a maximum $+2.3^{\circ}\text{C}$. The minimum and maximum road temperatures were -0.6°C and -3.3°C , respectively. The road surface could be characterized as moist. There was some light snow on the road surface at the beginning of the observation. Salting took place at 10:14 with an application rate of 30 g/m^2 with prewetted salt (Figure 9).

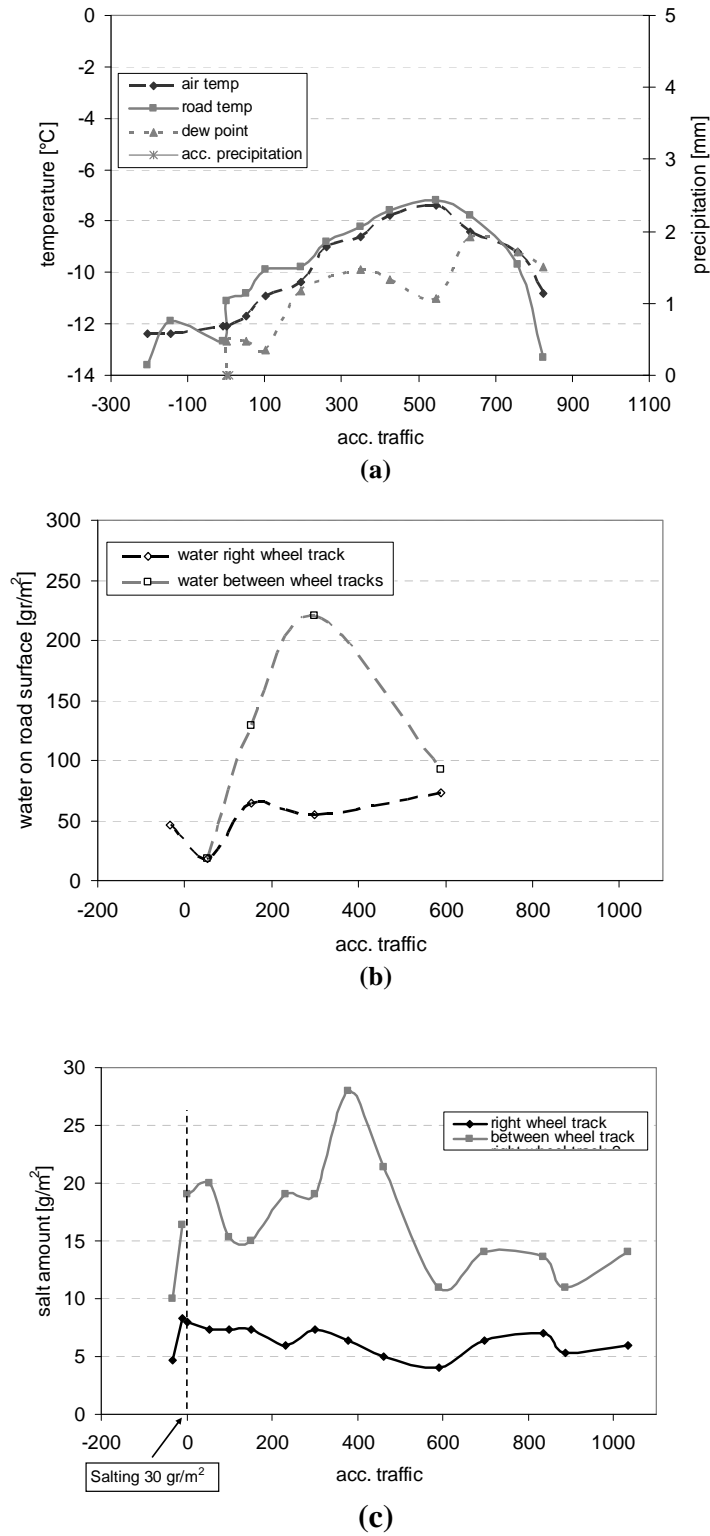

FIGURE 5 The data recorded in Case 1: (a) weather parameters, (b) amount of water on road surface, and (c) salt amount on road surface.



(a)



(b)

FIGURE 1 The observation place at (a) 07:50 and (b) at 12:43.

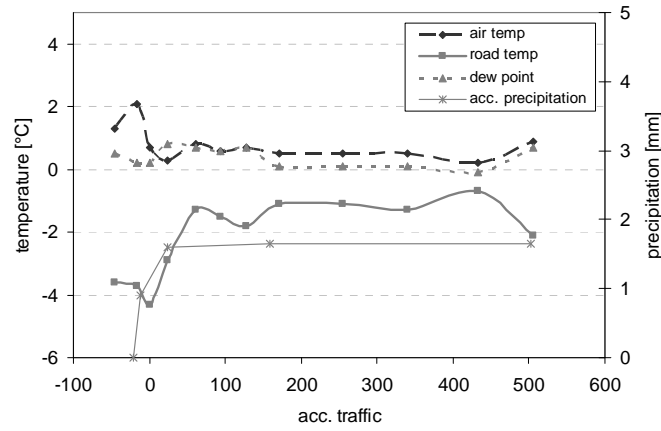

(a)



(b)

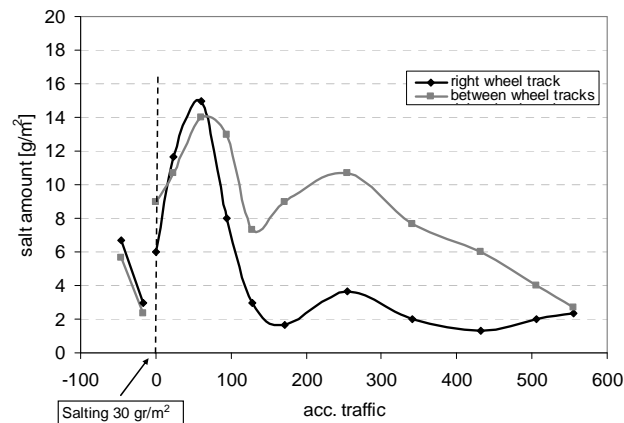

(c)

FIGURE 7 Data collected in Case 2a: (a) weather parameters, (b) amount of water on road surface, and (c) salt amount on road surface

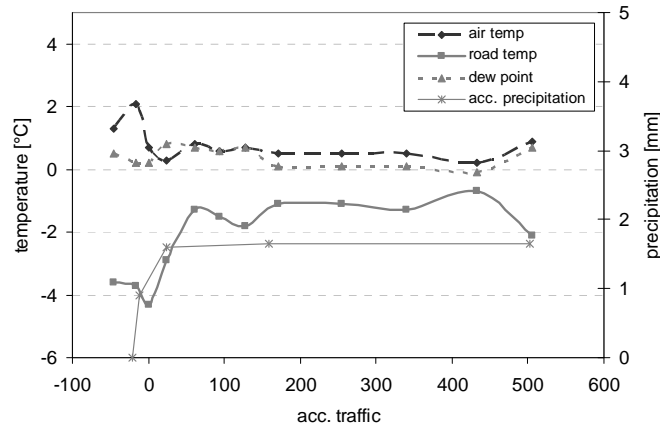

(a)

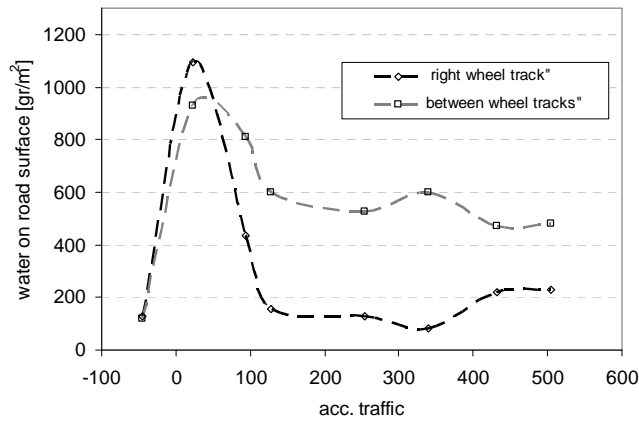

(b)

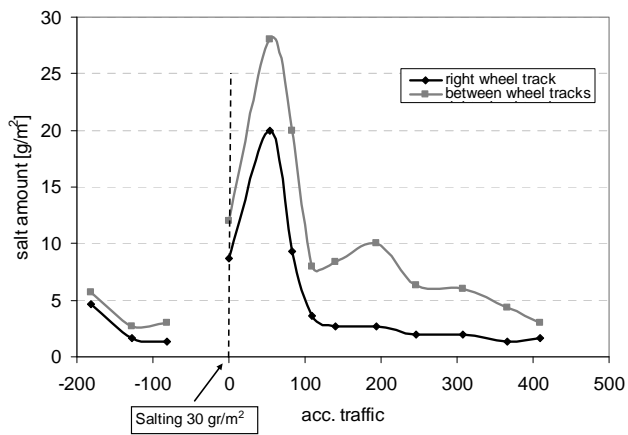

(c)

FIGURE 8 Data collected at Case 2b: (a) weather parameters, (b) water on road surface, and (c) salt amount



(a)



(b)

FIGURE 9 The observation point at (a) 09:21 and (b) 16:15.

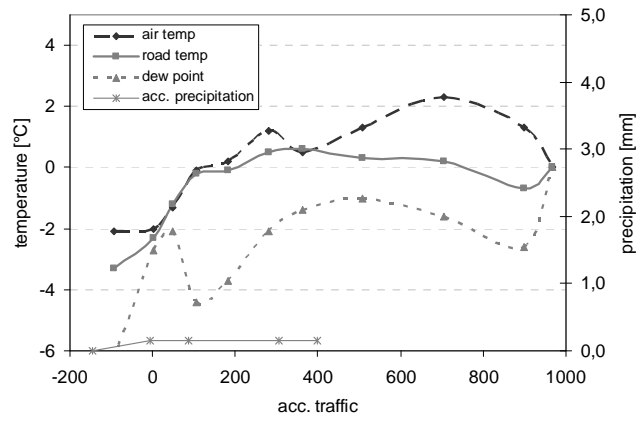

(a)

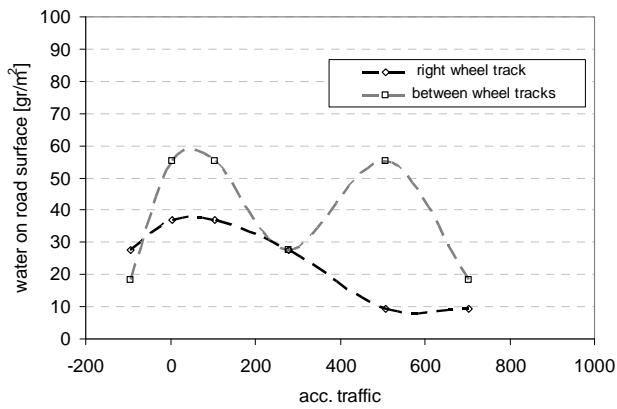

(b)

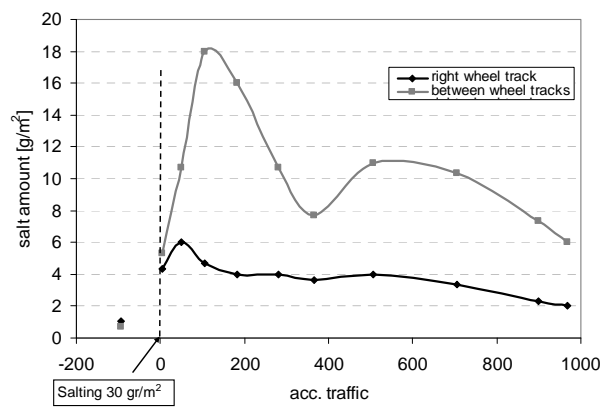

(c)

FIGURE 10 Data collected for Case 3: (a) weather parameters, (b) water on road surface, and (c) salt amount.

DISCUSSION OF RESULTS

Dissolving of Salt

The first important fact one should have in mind when analyzing the results from measurements of salt amount is the limitation of the instrument SOBO. SOBO measures the electric conductivity in the measuring fluid. This means that SOBO measures the salt dissolved in the measuring fluid. Tests have shown that the measuring fluid dissolves solid salt that lies inside the measuring area only to a limited extent. If there is a lot of undissolved salt on the road surface, SOBO will only measure a certain ratio of the salt that is present. The fact that SOBO measures little of the undissolved salt on the road surface explains the shape of the curves that plot salt amount versus time or traffic. If SOBO has measured the total amount of salt on the road surface, one would expect a curve like in Figure 11a. The highest amount of salt should be measured immediately after salt application. Instead measurements with SOBO show a development as in Figure 11b. These are idealized curves. The general trend is that immediately after application the measured salt amount is low, then the amount of salt increases before there is a decline in the salt amount when the mechanisms of salt loss become dominant. The first part of the curve before the peak occurs can be explained by the fact that there is a time- and traffic-dependent process where salt is being dissolved. The salt is present, but is not detected with a measuring instrument like SOBO. As more of the salt dissolves, more salt is measured by SOBO.

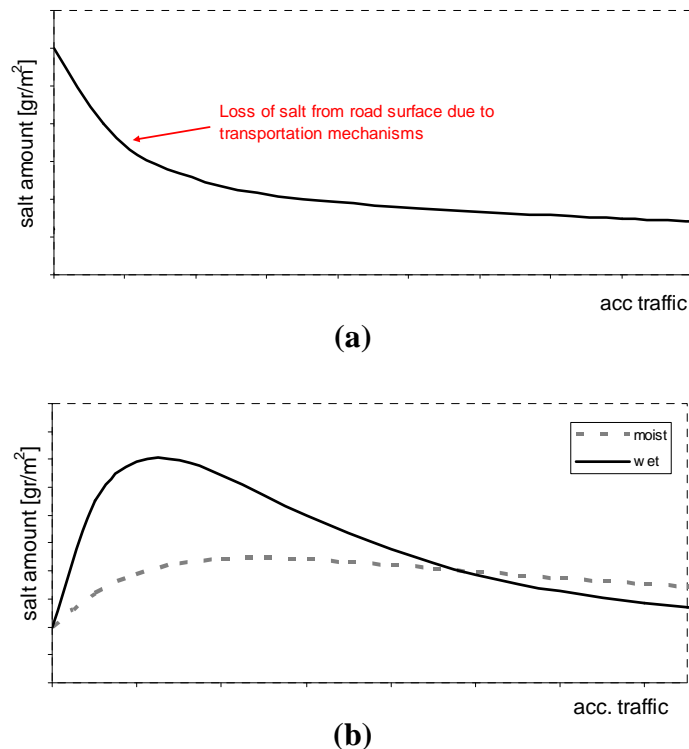

FIGURE 11 Idealized curves for the development of salt amount after salting actions: (a) expected development of salt amount after salting actions and (b) salt amount measured with SOBO 20.

One can also see that the shape of the curve is different when observing salting on wet road surfaces versus moist road surfaces. On a wet road surface there is a clear gradual rise in measured salt amounts and relatively high peaks followed by a rapid loss. In cases where only the road surface is moist, there is neither a rapid rise in measured salt amount nor a high peak value. The cause for these differences is that on a road surface with small amount of moisture there is insufficient water present to dissolve the salt to the same extent as on a wet road surface. The solubility curve for salt shows that at 0°C 1 g of salt needs approximately 2.8 g of water to be fully dissolved (salt brine is saturated at 26.3 weight percent of salt at 0°C). Theoretically that means that if dry salt is spread with a rate of 30 g/m² there has to be 84 g/m² of water present to fully dissolve the salt. This aspect, combined with the notion that dissolving is time dependent, explains the differences between a moist and a wet road surface. On moist road surfaces, when most of the salt is finally dissolved and thereby is detected by the SOBO instrument, much of the salt is blown and sprayed off the road. These differences between moist and wet road surfaces can be seen clearly when comparing results from field observations. The amount of water is important for the process of dissolving salt and, thereby, salt that is detected by SOBO can also be seen clearly in cases 1 and 3 and in [Figures 5 and 10](#). In these cases there is a substantial difference in the amount of water inside the wheel tracks compared with between wheel tracks. For this reason there is a more rapid rise and larger amount in measured salt between wheel tracks compared to inside wheel tracks. The amount of salt is also higher between wheel tracks due to the redistribution within road surface.

Loss of Salt

The transport mechanisms of salt depend on the amount of water present on road surfaces as indicated in the section on mechanisms that control the amount of salt on road surfaces. [Figure 12](#) shows the salt amount in wheel tracks plotted as a function of traffic for all four cases. The data points are grouped into wet or moist road surface according to the definition presented in [Table 2](#).

Immediately after spreading one should be careful to compare the data for moist and wet road due to the fact that SOBO does not measure dry salt, and to limited degree, dissolves dry salt. Exactly where the data is comparable (all salt dissolved) is not known. Considering [Figure 12](#) the data shows that there is a more rapid loss of salt on wet road surfaces. The magnitude of the loss is also greater on wet compared to moist road surfaces. After about 150 cars the amount of salt is clearly higher on moist road surfaces compared to wet road surfaces. The mechanism of spray-off on wet road surfaces seems to be more important compared to the blowoff effect on moist road surfaces. The salt seems to be present longer on the road surfaces on moist compared to wet road surfaces. This is because on a moist road surface when finally the salt is dissolved there is no or very little spray-off.

The results from the field observations clearly show that the amount of water on road surface is controlling the development of salt on road surface after salting actions. How wet the road surface is will decide what type of loss mechanisms that governs the development and the magnitude of the loss mechanisms. A dry or little moist road surface will give a large blowoff effect, but no or little spray-off and no runoff. More amount of water will give more spray-off and at a wet road surface one will also have runoff.

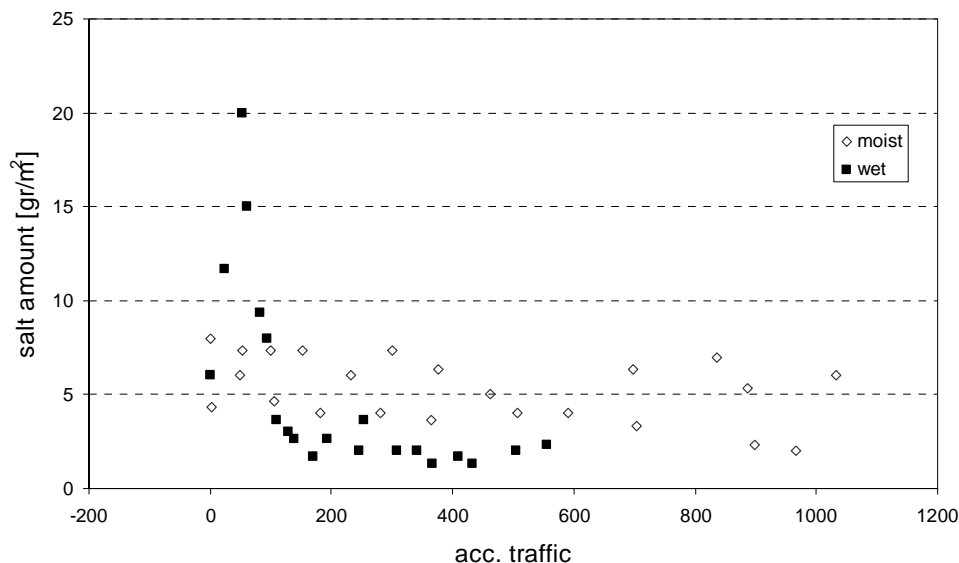

FIGURE 12 Salt amount inside wheel tracks. Data from all four case studies grouped according to wet and dry road surface.

CONCLUSION

The removal of salt from road surfaces is described by the three mechanisms blowoff, spray-off, and runoff. The controlling parameters are discussed and can be grouped in weather, traffic, and road characteristics.

Field observations including salt amount measurements have shown interesting results with respect to the discussion of the transport mechanisms. The results have shown that the amount of water controls the development of salt on the road surface. Road surface wetness determines which removal mechanism that is dominant and the magnitude of the loss. The dissolving of salt is highly dependent on amount of water on road surface. It is shown that the development of salt amount on road surfaces are substantial different on moist road surfaces compared to wet road surfaces. On wet road surfaces there is a more rapid rise and fall of salt amount compared to moist road surfaces. There is a higher maximum value on the amount of salt on wet road surfaces that can be detected with the used instrument. However, on moist road surfaces the salt remains longer on the road surface because of less or no spray-off. This means that there are higher amount of salt on moist road surface compared to wet after the same amount of traffic has passed.

The instrument SOBO can be used examine the questions addressed in this work, but the results should be interpret in considerations of the known the limitations of SOBO. Further exploration of the mechanisms of blowoff and spray-off requires the development of an instrument than can measure the total amount of salt, not only the dissolved salt.

ACKNOWLEDGMENTS

The authors thank the Norwegian Public Road Administration and Tore Hoven for the financial support of this work. Also thanks to our colleague, Alex Klein-Paste, for his valuable comments on this paper.

REFERENCES

1. Blomqvist, G., and M. Gustafsson. Patterns of Residual Salt on Road Surface: Case Study. In *Transportation Research Circular E-C063: Sixth International Symposium on Snow Removal and Ice Control Technology*, Transportation Research Board of the National Academies, Washington, D.C., 2004, pp. 602–608.
2. Hunt, C. L., G. F. Mitchell, and W. Richardson. Field Persistence of Anti-Icing Sodium Chloride Residuals. *Transportation Research Circular E-C063: Sixth International Symposium on Snow Removal and Ice Control Technology*, Transportation Research Board of the National Academies, Washington, D.C., 2004, pp. 609–622.
3. Glue, T. *Restsaltmengdernes afhængighed af trafikken*. Report (in Danish), 2000.
4. Elvik, R., and P. Greibe. *Safety Aspects Related to Low Noise Road Surfaces*. EUROPEAN COMMISSION DG TREN - GROWTH, SILVIA, Sustainable Road Surfaces for Traffic Noise Control, 2007.
5. Nygaard, H. *Rapport Restsaltmåleren SOBO 20*. Report (in Danish), Vinterudvalget, Denmark, 2003.

CHARACTERISTICS OF MATERIALS

Wet Dust Sampler*Technological Innovation for Sampling Particles and Salt on Road Surface***PER JONSSON****GÖRAN BLOMQVIST****MATS GUSTAFSSON***Swedish National Road and Transport Research Institute*

A new technique to sample dust on road surfaces is presented. It is based on the use of water to wash a road surface, hence the name wet dust sampler (WDS). The sample water is collected allowing for a range of analyses. The WDS is a prototype, and this technical note describes the development of the equipment, problems encountered, performance and repeatability, and suggested areas of use.

Measured concentration of particles in the ambient air is dependent on several factors. Road surfaces can be a major source in road environments, especially where pavement wear is accelerated due to the use of studded winter tires (1).

How pollutants and particles accumulate on paved surfaces has been subjected to several investigations. There are two primary ways in which accumulation can be viewed. First, the surface may be washed clean of pollutants during rain events to leave space for a new period of accumulation. Second, only parts of the pollutants are transported away during rain events. Refilling of the depot is quicker, and the mass of the total pollutant load is nearly constant (2). The same authors found from field experiments that the total mass of particles increases during dry days and decrease at rain events. After rains, the accumulation rate is high but tended to decrease after a few days as the material is redistributed. These results influence to some extent the way PM_{10} is formed: material is always present regardless of rain intensity and duration.

The size distribution of particles on road surfaces is important since it determines their mobility. The median diameter of all particles, d_{50} (where 50% of all particles are smaller in terms of mass), has been reported to be ranging between 150 to 4,000 μm (3). Besides particle size distribution, the resuspension of particles from road surfaces is influenced by vehicle speed and turbulence (4, 5), tire type (i.e., studded versus friction winter tires) (Tervahattu, 2007, unpublished data), surface wetness (6), and surface texture (7). All of these aspects have implications for the ambient air quality. Knowledge of the particle depot on a road surface is an important tool to assess forthcoming air quality situations.

Several methods have been developed to evaluate the amount of particles on a road surface (e.g., the silt load method according to EPA AP-42). However, a quick way of sampling their occurrence on a road surface has been missing. This has been the rationale for the development of wet dust sampler (WDS). The objective of this paper is thus to describe the design, function, and repeatability of the WDS.

OVERVIEW OF THE WET DUST SAMPLER

At the Swedish National Road and Transport Research Institute (VTI) a prototype for sampling of road surface particulate matter has been developed. The WDS is designed to collect all loose material available on a surface, regardless of particle size. The collected material can be studied with respect to size distribution, enabling calculation of the amount less than 10 μm in diameter (PM_{10}).

The prototype has been named WDS since water is used as the medium that loosens and transports the collected material (particulate matter) to a sample bottle. The principle is that a surface is cleaned with a high-pressure wash appliance. The nozzle is mounted in a cylinder that has a rubber beading. As the user is standing on the platform encircling the cylinder, enough load is put on the rubber beading to make it air and water tight. A circular spot is then washed cleaned and the loosened material is suspended in the water. In a latter phase of the cleaning an air compressor presses the sample volume to a collection bottle. The water sample then can be studied according to desired application. [Figure 1](#) shows the different parts of the WDS.



FIGURE 1 Overview of the WDS electrical appliances (*left*): the high-pressure wash appliance, the compressor, and the control unit. The sampling unit is shown at the right.

The control unit regulates the start–stop times of the high-pressure washer and the compressor. Both can be adjusted.

Figure 2 depicts a side view of the sampling unit connected to the WDS, while Figure 3 shows the underside of the sampling unit. Two leakage barriers are visible; the inner collapses when put under the operator’s weight and the outer further helps to air and water tighten the device.

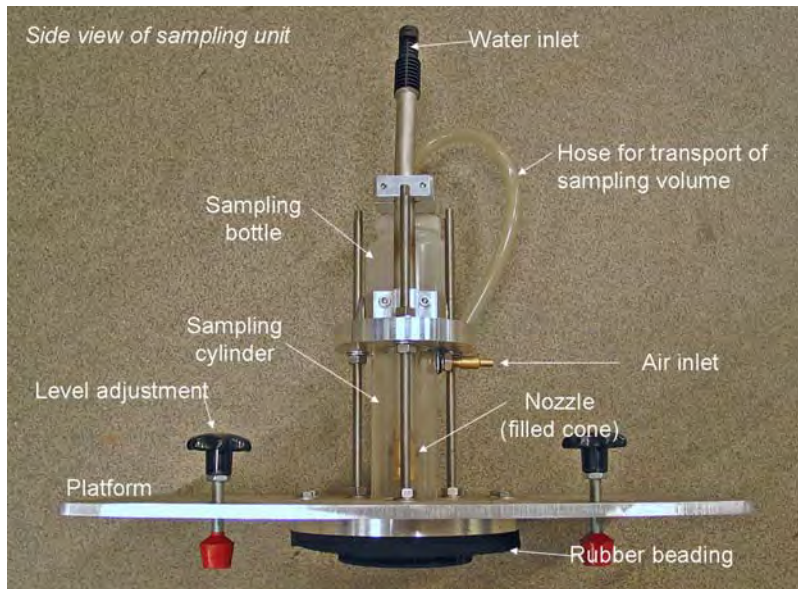

FIGURE 2 Side view of the sampling unit.

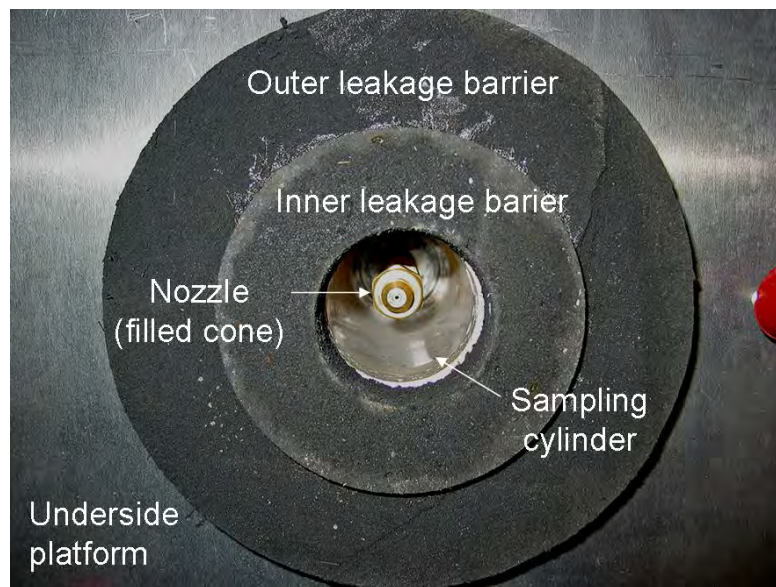

FIGURE 3 View of the underside of the sampling unit, showing the rubber beading.

The water being used in the field is deionised in order to enable chemical analysis of the collected material. The water is stored in a portable 20-L tank. Electricity is provided by a 12-volt battery, connected to a 220-volt transformer that powers both the high-pressure wash appliance and the compressor. Figure 4 shows the WDS under a test.

The WDS can be used for a variety of applications that are all relevant for both winter and summer road maintenance strategies. These include

- Comparison of dust load on a road surface and measured concentration of PM_{10} in ambient air during different seasons;
- Measurement of dust load before and after selected road cleaning–sweeping strategies;
- Investigation of size distribution and chemical composition of road dust on different roads and in different seasons;
- Comparison of chemical composition of road dust with possible sources (e.g., pavement aggregates, brakes, tires);
- Investigation of the amount of dust on different pavements and the relation to pavement texture, stone aggregate composition, and pavement structure; and
- Sampling of residual salts on the road surface for further chemical analyses.

However, before the WDS can be used for these applications its performance and repeatability need to be investigated.



FIGURE 4 The WDS during sample retrieval.

EVALUATION OF THE WDS's PERFORMANCE AND REPEATABILITY

A testing scheme of the WDS was designed. In particular, the repeatability of sample runs was considered important. Four different areas were investigated with respect to repeatability: supplied water volume from high-pressure washer, collected water volume, ability of WDS to collect dust from surface, and the procedure of analyzing the dust content. The need to modify the equipment was encountered during the tests and these are described in this section as well.

Supplied Water Volume and Recovered Volume

The WDS is equipped with a control box that regulates the time the high-pressure washer and the compressor are operating. By pressing the handle the entire sampling procedure is engaged.

Supplied water volume was measured by putting the nozzle in a measurement cylinder. The test was performed with different amounts of water in the 20-L tank (full and half full, respectively) to elucidate whether different water pressures had an influence, both with battery power and with mains operation. The test was repeated 20 times for both power supplies (Table 1 and Figure 4a).

A certain difference in supplied water volume as a function of water volume in the tank can be seen. The standard deviations of the two data series do not overlap indicating that the data series are significantly different, but not necessarily so. Less water is supplied with lower level in the tank, possibly as a result of lower pressure. However, there are small differences when the two power sources are compared (Table 1).

Collected Volume of Water

Once it was clear that the WDS supplies the approximate same amount of water between trials, the next question was how well the collection of sample water could be repeated. This was investigated by using the WDS on different surfaces with different roughness. The surfaces were an impermeable mat with no texture, fine-, medium-, and coarse-grained asphalt, respectively. The difference between the asphalts was decided visually with no thorough investigation of porosity, etc. The results are shown in Table 2 and in Figure 4b. Additional tests were made after the rubber beading has been modified to include an inner and an outer part.

TABLE 1 Supplied Volume of Water from High-Pressure Washer

Studied Parameter	<i>N</i>	Mean (ml)	Standard Deviation (ml)
Supplied volume, half tank (mains) c	20	753.2	8.2
Supplied volume, full tank (mains)	20	770.5	5.3
Supplied volume, full tank (battery)	10	771.5	3.4

TABLE 2 Collected Volume of Water from Tests on Different Surfaces

Studied Parameter	<i>N</i>	Mean (ml)	Standard Deviation (ml)
Collected volume, impermeable mat (mains)	17	682.1	3.1
Collected volume, fine grained asphalt (battery)	15	577.7	11.5
Collected volume, medium grained asphalt (battery)	15	543.0	14.1
Collected volume, coarse grained asphalt (battery)	15	542.7	25.7
Collected volume, concrete floor (mains, after modified beading)	15	673.2	4.0

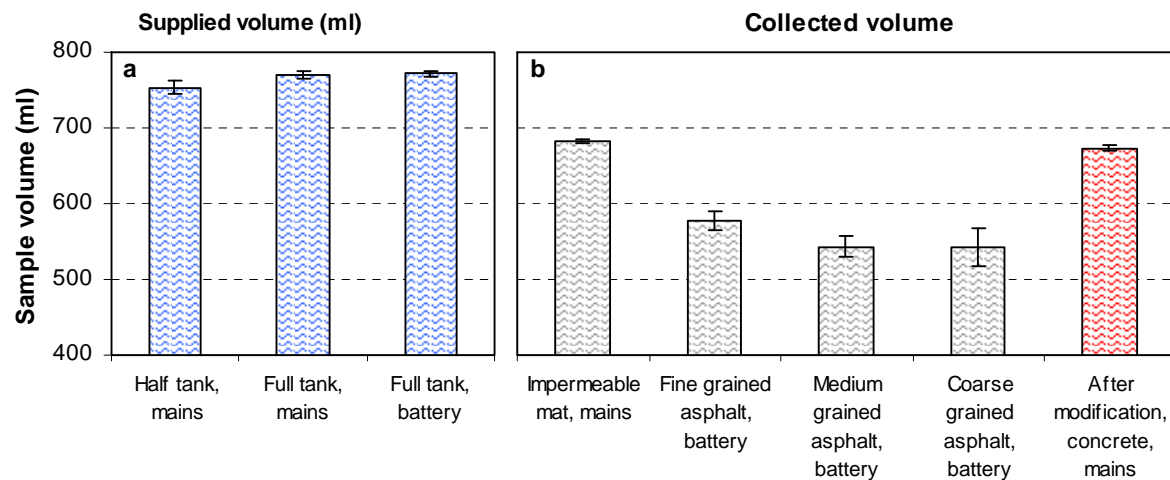
**FIGURE 4 Results of repeatability trials of (a) supplied volume of water and (b) collected volumes of water.**

The largest volume is collected when the WDS is used on a smooth surface, as in the case with the impermeable mat. Also, the standard deviation is small. In field trials with asphalt there is much larger variation in collected volume, both between asphalts types but also within each type. The largest volume is collected from the fine-grained asphalt that also shows the least variation. For the medium- and coarse-grained asphalts the variation is larger. There is a clear trend that the coarser the asphalt, the larger the variation in collected volume viewed as increased standard variation.

This can be attributed to a number of factors, the most important being how well the WDS keeps tight against the surface. Ideally, the operator should balance so that the weight is evenly distributed. Also, with increasing coarseness comes a larger degree of porosity that has bearing on leakage. The water that washes the surface is obviously leaking. It is reasonable to assume that this uncollected water also contains particulate matter. The WDS is therefore unable to collect all material it suspends in water. However, by making the assumption that the water volume is completely mixed and that the outtake is representative of the total volume, calculations may be performed using the mean value of amount of water used in the washing process.

Modification of the WDS

After the trials described above, it was clear that sampling coarse surfaces was a problem. The leakage barrier that used to be evenly thick across its width was therefore divided into two different barriers. The inner of these had lower contact surface, allowing it to collapse as the operator put weight on it and consequently create a tighter barrier. The first version also had wings for the operator to stand on. This was modified into a platform allowing the operator to put the full body weight on the leakage barriers and easier keep the balance (Figure 4).

Another problem was that the WDS washer had too-high pressure. This led the authors to suspect that material was loosened by the washer itself which was not the intention. The nozzle was therefore changed to a low-pressure nozzle with filled cone dispersion. This construction also ensures that the whole sample surface is cleaned. The nozzle can be changed if desired.

Evaluation of Repeatability of Collected Material from a Surface and Analysis of Dust Content

It is important that the repeatability of the WDS concerning collection of particles is high. Investigation of this matter is associated with problems, for example to find surfaces with the same particle load. The VTI road simulator hall was used for the purpose. In the hall pavement wear particles are generated and are assumed to deposit evenly on the floor. The WDS was tested at ten different, closely spaced, spots in the hall.

The collected water samples were filtered (Munktell 00H) and the filters were then burned at 550°C and the remaining material weighed. Two of the samples were contaminated and left out from further analysis. The results are shown in Figure 5 and indicate that the collected material varies in mass. Whether this is a result of uneven distribution of particles on the floor or a result of WDS's inability to collect particles is unknown. The collected mass was unexpectedly small indicating that this test should be made with coarser particles in larger amounts.

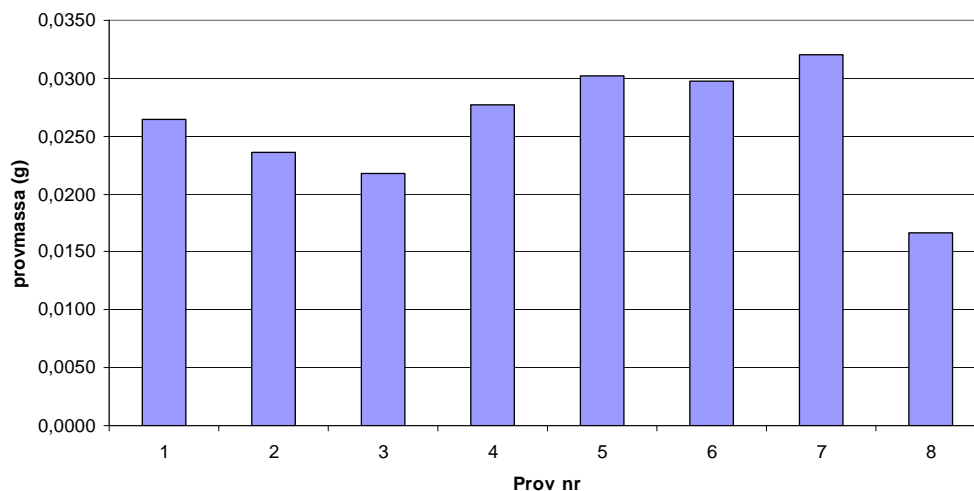

FIGURE 5 Collected material from concrete surface at eight closely spaced spots.

Collection of a Known Weight of Dust With Known Size Distribution

Yet another test was performed to investigate how much of a known weight particles could be collected. The WDS was tested on a plastic surface where approximately 0.5 g of filler material had been put over a small surface. Four samples were prepared and the results showed that the percentage of the original material collected ranged between 66.1% and 68.1%. This variation appeared to be dependent on collected amount of water (Figure 6). This has the implication that the concentration of dust in the water sample is the same.

In order to examine the ability of the WDS to collect all particle sizes in the dust sample described above, a part of the original dust material was dissolved in water and compared with the four collected samples (Figure 7). As can be seen, the WDS does a fairly good job in collecting all sizes. Analysis of the size distribution curves showed that approximately 5% of the material above 24 μm is missing in the sampled material as compared with the original material. This may be due to settling of these particles within the sampling process, and, hence, further calibration of the washing and air pumping starting and ending times may be needed.

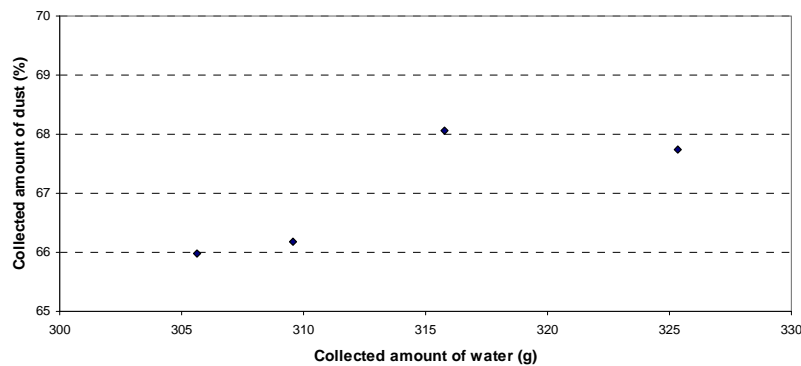

FIGURE 6 Relationship between collected amount of dust and collected amount of water.

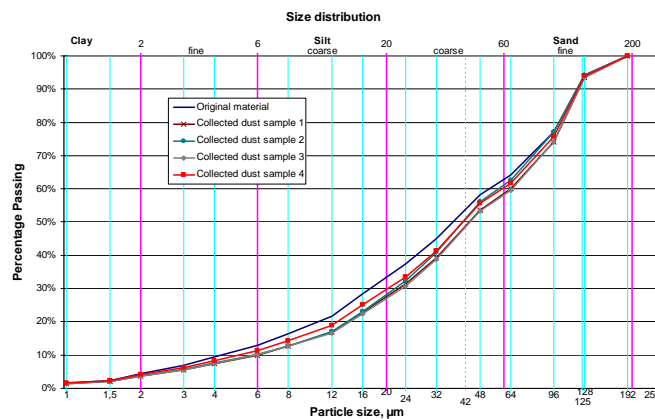

FIGURE 7 Comparison of size distributions of the original dust with the distribution of the four samples collected with the WDS.

Comparison of Salt Collection Efficiency from a Road Surface: WDS Versus SOBO

In order to evaluate the ability of the WDS to measure the amount of residual salt on a road surface, a comparison was made between the WDS and a SOBO 20 residual salt measurement device. The measurements were made in a field study where two segments of a road were sampled and measured. One segment was in the right wheelpath of the passing traffic, and the other was in the center of the road, in between the two driving directions. The results of the SOBO measurements were registered as the calculated NaCl values—the output of the instrument itself (g/m^2). The WDS samples from the two road surface segments, wheelpath, and road center, were transported to the laboratory and then analyzed for their chloride content. An assumption was made that the sample outtake is representative of the total volume of sprayed deionized water and that it is completely mixed with the salt washed up from road surface. Another assumption is that the salt content on the road surface is in a stoichiometric relation between the sodium and chloride ions as one to one. Therefore, the analyzed chloride content was multiplied by 1.65 in order to transform the chloride content to anticipated sodium chloride content. The wheelpath was measured by five SOBO measurements and seven WDS samples, and the road center was measured by eight SOBO measurements and three WDS samples.

The result is shown in Figure 8, where the mean values and the standard deviations at each test site are illustrated. It can be seen that both instruments measures differently. Whether it is the SOBO that underestimates or the WDS that overestimates the true salt content is unclear. It may also be some of the assumptions made that are incorrect and need to be reconsidered.

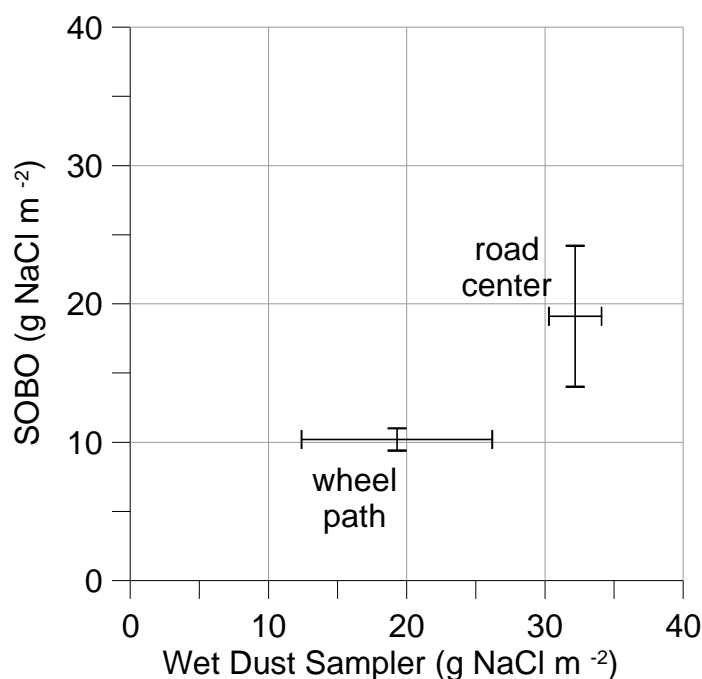

FIGURE 8 Comparison of calculated sodium chloride content of the WDS with the measured salt values of the SOBO 20. The crosses show the mean value of each test, and the whiskers show the standard deviation from the mean of each test.

CONCLUSION

The development of a new technical solution for the need of sampling road surfaces for dust and salt seems promising so far. The tests show acceptable repeatability of sampling both particles and salt. However, some further calibration is needed in order to reach a more optimized washing and sampling process. Once that has been done, the WDS provides a simple way of sampling particles and salt content of road surfaces and can be used for a large range of applications.

REFERENCES

1. Deletic, A., and D. W. Orr. Pollution Buildup on Road Surfaces. *Journal of Environmental Engineering*, Vol. 131, 2005, pp. 49–59.
2. Etyemezian, V., H. Kuhns, J. Gillies, J. Chow, K. Hendrickson, M. McGown, and M. Pitchford. Vehicle-Based Road Dust Emission Measurement (III): Effect of Speed, Traffic Volume, Location, and Season on PM₁₀ Road Dust Emissions in Treasure Valley, ID. *Atmospheric Environment*, Vol. 37, 2003, pp. 4583–4593.
3. Gustafsson, M., G. Blomqvist, A. Dahl, A. Gudmunsson, J. Lindbom, A. Ljungman, B. Rudell, and E. Swietlicki. *Inandningsbara partiklar från interaktion mellan däck, vägbana och friktionsmaterial*. Report 520, Swedish National Road and Transport Research Institute, 2005.
4. Omstedt, G., B. Bringfelt, and C. Johansson. A Model for Vehicle-Induced Non-Tailpipe Emissions of Particles Along Swedish Roads. *Atmospheric Environment*, Vol. 39, 2005, pp. 6088–6097.
5. Tsai, C. J., and S. F. Chiou. Measurement of Emission Factor of Road Dust in a Wind Tunnel. *Journal of Aerosol Science*, Vol. 30, 1999, pp. 5227–5228.
6. Vaze, J., and F. H. S. Chiew. Experimental Study of Pollutant Accumulation on an Urban Road Surface. *Urban Water*, Vol. 4, 2002, pp. 379–389.
7. Nicholson, K. W., and J. R. Branson. Factors Affecting Resuspension by Road Traffic. *Science of the Total Environment*, Vol. 93, 1990, pp. 349–358.

CHARACTERISTICS OF MATERIALS

Numerical Evolution of Deicer Amount on Pavement Surface

Traffic and Weather Influences

MARIO MARCHETTI

RODOLPHE DUVAL

JEAN LIVET

Centre d'Etudes Techniques de l'Equipement de l'Est, Laboratoire Régional des Ponts et Chaussées, Nancy

MAURICE FRANÇOIS

PHILIPPE PECQUENARD

Station d'Essais de Matériels Routiers

PIERRE GUILLEVIC

Laboratoire Central des Ponts et Chaussées

Deicers are used to maintain a proper grip in icy conditions. Tons of deicers are spread over French roads, and 20% to 30% of deicers could be saved. This study evaluates residual deicer on a road after a winter maintenance operation to assess and to improve safety. This could optimize the spread quantity to reach cost-effective spreading. The homogeneity of the amount of deicer on the road, the effect of precipitations, and the traffic influences has been studied. A 200-m highway section was selected. Patterns of sodium chloride from calibration data of winter maintenance vehicles were used. Precipitation data were used to modelize the water amount. Highway traffic intensity was used as an input. Their evolutions were taken over a 24-h period. Traffic includes trajectory distributions, and distinguishes cars from trucks. The deicer amount is calculated with a numerical model. The calculation considers a homogeneous weather over the whole road section. The traffic intensity depends on road location and on corresponding traffic distribution. The deicer removal is calculated hourly. For each passing vehicle, a fraction of deicer is lost, depending on tire size. Slopes and pavement markings create streaming heterogeneities: the higher the deicer concentration the better the protection against freezing. A color code identifies critical zones (in red) on the road stretch, where wheel tracks could be easily identified. A comparative analysis between and within lanes has been included.

In France, deicers such as NaCl are used to maintain a proper grip in icy conditions. Spread with a winter maintenance vehicle, they decrease the freezing point of the liquid phase on the pavement (1,2). The applied amount usually ranges between 5 to 15 g/m² up to 40 g/m². Its efficiency greatly depends on the atmospheric conditions, particularly the relative humidity, and is eased by the traffic. The freezing point of the brine on the pavement also depends on the water amount, from precipitation or condensation.

Very few studies could be found in the literature to quantify the evolution of residual deicer on pavement according to weather and traffic parameters (3,4,5). The aim of this work is to create a numerical tool to evaluate the residual patterns of deicers on pavement with time, as a function of the water amount and passing vehicles. Such a tool would lead to critical zones and help to optimize the amount used during winter, which financial cost could reach €55 million.

DESCRIPTION OF THE NUMERICAL MODEL

Pavement Section

A 200-m highway section was considered. It included the emergency lane (2.5 m wide), the right one mainly dedicated to trucks and the left one (each 3.5 m wide). The section is divided in 1-m \times 0.25-m cells. Conventional transversal slopes were used, with a 4% one for the emergency lane, and 2.5% for the rest of the pavement, while longitudinal slopes were not taken into account. Markings locally modify pavement roughness and might change fluid streams. Highway legal markings were 3 m long, with 10-m space between them for the traffic lanes. Emergency lane has 38 m long markings, with 14 m space. All of them were 0.005 m thick. Such a thickness causes accumulation of water as illustrated on Figure 1.

Water from Precipitation

Because of rainfall, some water is accumulated on the pavement. This causes a dilution of the brine appeared once the deicer has been applied. The freezing point of the fluid is therefore

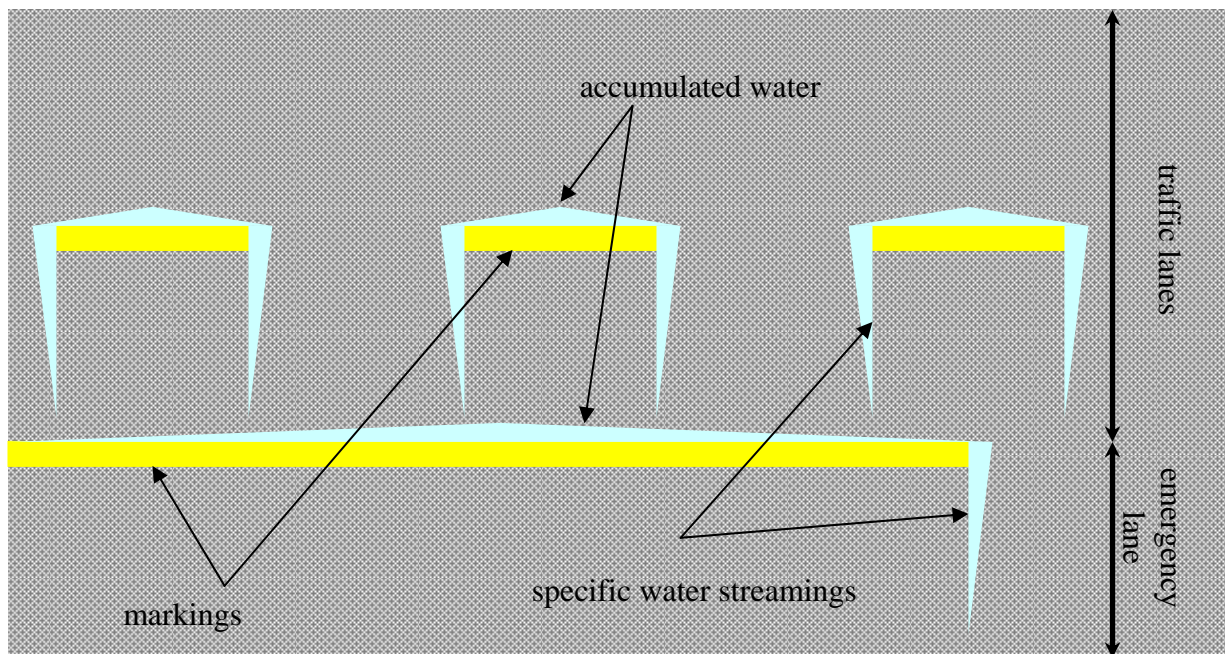

FIGURE 1 Pavement section with water accumulation anomalies due to markings (not at scale).

getting closer to 0°C. The amount of rain has been considered as uniform and homogeneous over the 200-m section. Based on meteorological data over several 24-h periods, a numerical model, employed by Laboratoire Central des Ponts et Chaussées (LCPC), gave the water film thickness on the pavement. The maximum amount of water to be stored on the surface before the streaming due to the transversal slope appeared was chosen as 0.00025 m. This numerical model, called SISPAT (Simple Soil Plant Atmosphere Transfer) is a vertical model with coupled heat and water transfer between the ground, atmosphere, and vegetation (6).

In the chosen description, it has been assumed that the water film thickness immediately reached its equilibrium value. Furthermore, when the streaming conditions were met, water and de-icer were both carried out. The porosity of the pavement is not considered here though there is a large amount of papers dealing with infiltration of de-icer in concrete structures. The diversity of pavements did not allow taking easily such a parameter into consideration.

Traffic on the Highway Section

Traffic has many incidences on the amount of deicer present on a pavement. One of the first effects is that cars are carrying onto their tires some materials from one spot to another. This has been described by Livet et al. in the mid-1990s (7). As shown by Blomqvist et al. (3), it also causes a significant decrease of deicer in the wheel tracks. In windy conditions, some losses could be monitored with deicer being carried out several hundreds meters out of the road (4). Such a loss greatly depends on the roughness and porosity of the pavement. The description chosen in this numerical model solely uses the spreading of deicers by passing vehicles.

To evaluate the impact, some highway traffic data were considered over a 24-h period. The data distinguish cars from trucks. Different tire sizes and vehicles widths were chosen. In the case of cars, the width was 1.5 m, while it reached 2 m on trucks. Tire sizes were 0.15 and 0.50 m for cars and trucks, respectively.

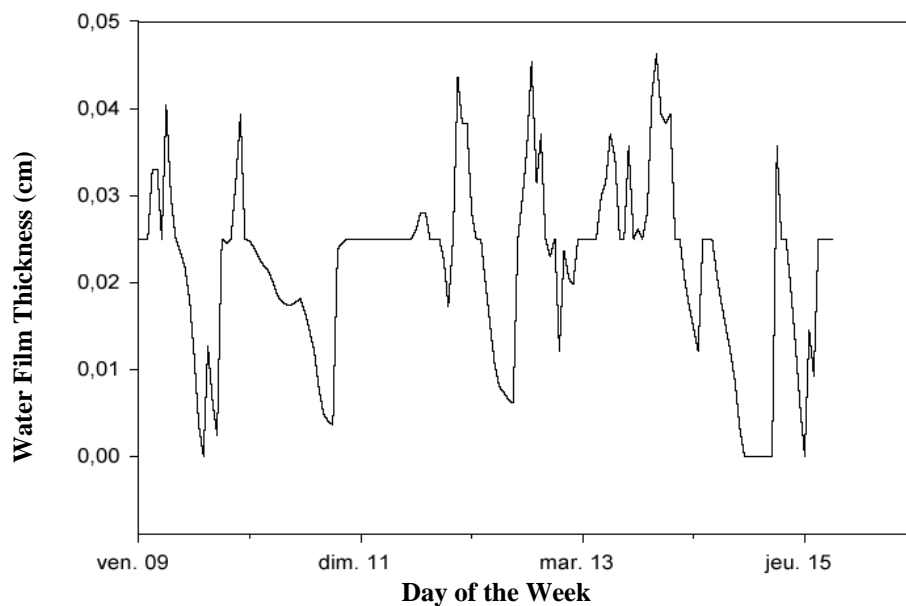

FIGURE 2 Water film thickness on the pavement as a function of time.

Trajectories of vehicles were considered as gaussian in each lane. Such a choice includes variations appearing on roads. Distributions D_{cars} and D_{trucks} were a function of the distance “dist” of the passing vehicle to the road side, and of tire size “tis.” Each distribution is centred on the wheel tracks, located at “distWT” of the roadside. These distances were chosen as 3.25, 5.25, 6.75, and 8.75 m for cars. For trucks, there were 3.25, 4.75, 6.75, and 8.25 m. The standard deviations of these distributions were respectively of three times the tire size for cars in the right lane, and the tire size for trucks in the same lane. In the other lane, there respectively were two times the tire sizes of the corresponding vehicles. The equations of the distributions are summarized below.

Distributions for right lane:

$$D_{cars} = \frac{1}{\sqrt{2\pi \cdot 3 \cdot tis_{cars}}} \bullet \exp\left(\frac{-(dist - distWT)^2}{(3 \cdot tis_{cars})^2}\right) \tag{1}$$

$$D_{trucks} = \frac{1}{\sqrt{2\pi \cdot tis_{trucks}}} \bullet \exp\left(\frac{-(dist - distWT)^2}{(tis_{trucks})^2}\right) \tag{2}$$

Distributions for left lane:

$$D_{cars} = \frac{1}{\sqrt{2\pi \cdot 2 \cdot tis_{cars}}} \bullet \exp\left(\frac{-(dist - distWT)^2}{(2 \cdot tis_{cars})^2}\right) \tag{3}$$

$$D_{trucks} = \frac{1}{\sqrt{2\pi \cdot 2 \cdot tis_{trucks}}} \bullet \exp\left(\frac{-(dist - distWT)^2}{(2 \cdot tis_{trucks})^2}\right) \tag{4}$$

Once these distributions are normalized, the probabilities to find a vehicle at a given distance could be easily established. The asymmetry obtained with this description is consistent with field observations from the literature (3).

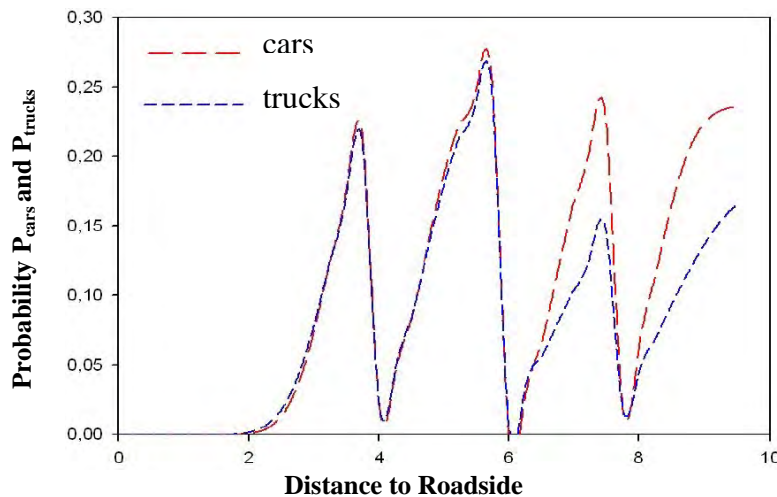

FIGURE 3 Probabilities to get a passing vehicles as a function of the distance to roadside.

Deicer Application on the Pavement

Deicers are usually applied by winter maintenance vehicles at a speed close to 50 km/h. The spreading could be done on several widths depending on the nature of the road. In our case, a 10-m wide deicer flow was considered and based on measurements run at the SEMR. As expected, some transversal heterogeneity was observed. A calibration of the spreader system was conducted, and some longitudinal heterogeneity was monitored also. Based on these two sets of data, a bidimensional mapping of deicer on the pavement was built. It consisted in a homothetic transfer of the transversal and longitudinal deicer profiles, as illustrated in Figure 4. In Figure 4c, the amount of deicer appeared as successive waves, and indicated that despite a careful calibration, some heterogeneities might still exist.

CALCULATION OF AMOUNT OF RESIDUAL DEICER PATTERNS

Definition of Deicer Mass Title

The deicer mass title on a pavement could be defined as the mass of deicer with respect to the total mass of material on this road. Only the water and the deicer were considered to be present on the road. Indeed, most deicer applied did not have more than 10% of impurities (mainly silica). As explained before, the road section was divided into 1×0.25 -m cells. In the model, the deicer mass title is calculated in each cell taking into account two main parameters: the amount of water on this cell and the number of passing vehicles. Therefore, the mass of deicer on a road could be simplified as the following expression:

$$\begin{aligned} (\text{mass of deicer}) (t) = & (\text{mass of deicer applied}) (t = 0) - (\text{mass of deicer lost due to traffic}) (t) \\ & - (\text{mass of deicer lost due to precipitation}) (t) \end{aligned} \quad (5)$$

Two indexes i and j to number the different cells of the 9.5×200 -m road stretch. Then the deicer mass title on a cell (i, j) , $\text{DIMT}(i, j)$ could be given by the following formula:

$$\text{DIMT}(i, j) = \frac{\text{DIM}(i, j)}{\text{DIM}(i, j) + \text{WAT}(i, j)} \quad (6)$$

where $\text{DIM}(i, j)$ and $\text{WAT}(i, j)$ are respectively the deicer mass and the water mass on the cell (i, j) . Once established the ways $\text{DIM}(i, j)$ and $\text{WAT}(i, j)$ might evolved with the traffic and the precipitations, and these parameters known as a function of time, the variation of the deicer mass title as a function of time could be established. As expected, in case of rain, $\text{WAT}(i, j)$ would increase and $\text{DIMT}(i, j)$ would consequently decrease. The water film thickness evolution from Figure 2, which illustrated the weather changes, would clearly cause increases and decreases in the deicer mass title, and therefore variations in the freezing point of the liquid phase onto the pavement.

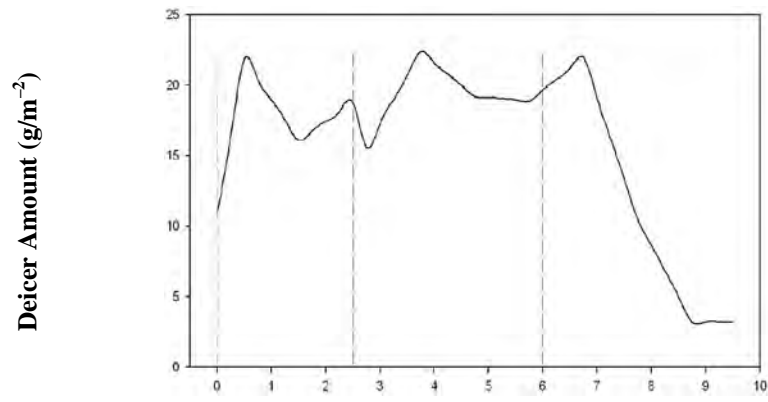

(a)

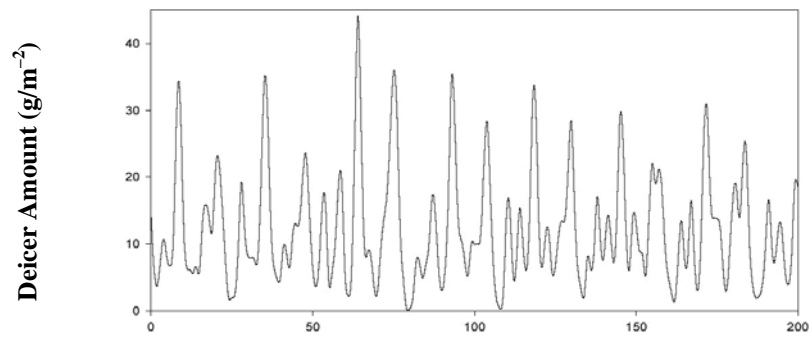

(b)

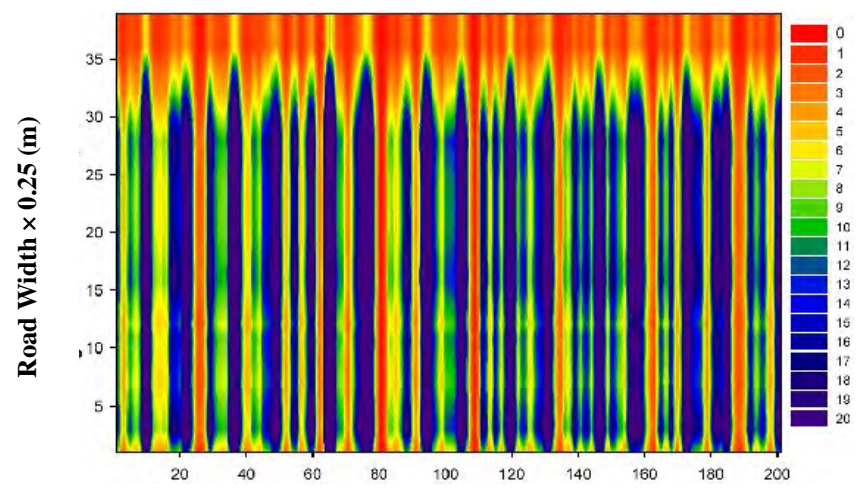

(c)

FIGURE 4 Example of transversal, longitudinal, and pavement amount of deicer: (a) example of transversal distribution of deicer (in g/m^2), (b) example of longitudinal distribution of deicer (in g/m^2) over a 200-m road section, and (c) brine mass title (in %) applied by a winter maintenance service over a 200-m road section [0% in red (no deicer), 20% in deep blue (close to a $-23^\circ C$ freezing point)].

Effect of the Water from Precipitations

The main effect of water from precipitations is the dilution of the brine currently on the pavement. The greater the dilution, the closer of 0°C the freezing point.

Obviously, depending on the treatment applied on the road section (i.e., dry deicer, wet one, or directly brine), some time might be necessary to create the brine, solely able to ease the melting of ice or of snow. In our description, the brine was considered as immediately created once the deicer on the road. Such a description could cause a time shift compared to what could be observed in the field.

As explained before, the water film thickness on the pavement is estimated through the SISPAT numerical model. Since no pavement porosity was considered, the water from the precipitations reached an equilibrium thickness depending on the pavement nature, and chosen here at 0.00025 m. With such a description, and having the brine at proper concentration right after the precipitations, the loss due to streaming was directly taken into account.

$$WAT(i, j) = WATFT(i, j) \bullet SurfCell(i, j) \quad (7)$$

where

$WAT(i, j)$ = mass of water on the cell (i, j) ,

$WATF(i, j)$ = water film thickness obtained from SISPAT (Figure 2), and
 $SurfCell(i, j)$ = area of the cell.

The density of the water was considered as equal to 1 g/cm³.

Evaluation of Deicer Carried Out by the Traffic

Due to traffic, the deicer applied on the road is carried out from each cell (i, j) . After each passing vehicle, a fraction q_{vehicle} of deicer is removed by this vehicle. The phenomenon depends on the nature of the pavement. The smoother the pavement, the greater the amount removed. This situation was shown by Livet et al. (7) and by Blomqvist et al. (3). Therefore, the deicer amount on any road stretch gradually decreases with such description, as indicated in the literature.

The amount of deicer for cells (i, j) in the wheel tracks was noted $DIM^{(p)}(i, j)$ after p_{vehicle} passing vehicles. Considering it was $DIM^{(0)}(i, j)$ before any vehicle, it could be stated that

$$DIM^{(p)}(i, j) = \sum_{\text{passing vehicles}} (1 - q_{\text{vehicle}})^{p_{\text{vehicle}}} \bullet DIM^{(0)}(i, j) \quad (8)$$

The fraction q_{vehicle} described the amount of deicer removed, and two coefficients were selected respectively for cars and for trucks. They typically ranged from 10⁻⁶ to 10⁻²: the higher these coefficients the faster the disappearance of the deicer. These parameters could modelize the roughness of the pavement. As indicated before in the section on traffic on the highway, each passing vehicle on the road stretch had a probability of being on a cell (i, j) . Then the amount of deicer in each cell (i, j) $DIM(i, j)$ could written as

$$\text{DIM}(i, j) = \text{DIM}(i, j)(t = 0) \cdot \left(N_{\text{cars}} \cdot P_{\text{cars}} \cdot (1 - q_{\text{cars}})^{N_{\text{cars}}} + N_{\text{trucks}} \cdot P_{\text{trucks}} \cdot (1 - q_{\text{trucks}})^{N_{\text{trucks}}} \right) \quad (9)$$

where N_{cars} and N_{trucks} were the numbers of cars and trucks at a given time, and P_{cars} and P_{trucks} the corresponding probabilities to find these vehicles on the cell (i, j) , as illustrated in Figure 3. Such a description could be applied to any cell of the selected road section. Indeed, out of traffic lanes, $N_{\text{cars}} \cdot P_{\text{cars}}$, and $N_{\text{trucks}} \cdot P_{\text{trucks}}$ were equal to zero. Therefore, the mass of residual deicer would only be affected by the precipitations.

Specific Case of the Markings on the Pavement

Because of the thickness of the markings MarkTh onto the pavement, some accumulation of water occurred, as illustrated on Figure 1. The accumulation was chosen only on a cell width, i.e., 0.25 m, over the length of the marking. Once this volume was filled, an overflow equally occurred on both side of the marking, and over the width of the road between the marking and the roadside. Since no longitudinal slopes were considered, only cells directly on both sides of the marking were affected. Therefore, the main test consisted in checking if the amount of water from precipitations overtook the available accumulation volume. The maximum volume in cm^3 that could be accumulated due to the presence of marking was

$$\text{VolAccMark} = \frac{1}{2} \cdot \text{MarkTh} \cdot 0.25 \cdot 1000 \quad (10)$$

Once the comparison established, the potential excess of water WATXS was spread in a transverse way down to the roadside (Equation 11).

$$\text{WATXS} = \text{WATFT}(i, j) \cdot \text{SurfCell}(i, j) - \text{VolAccMark} \quad (11)$$

The volume is divided by a coefficient DivCoeff, set to two, from one transverse cell to the next, until the volume to be spread is below a given level that could be neglected, as described in Equation 12. Then, if WATXS is zero, only water from precipitations is considered to evaluate the residual amount of deicer on the road.

$$\text{WAT}(i, j) = \text{WATFT}(i, j) \cdot \text{SurfCell}(i, j) + \frac{\text{WATXS}}{2} \cdot \frac{1}{\text{DivCoeff}} \quad (12)$$

Limits of the Chosen Description

Such a description could easily be improved. One first step could be to include longitudinal slopes of a road stretch. Furthermore, the porosity of the pavement is not included, which means that some losses were definitely neglected here. The deicer mass title is a complex function of the temperature. The colder the system, the harder it is to get a highly concentrated solution of deicer. As an example, the mass title of saturated brine is 23% at room temperature, but not at 0°C . Traffic has many impacts, and the spreading was one. Some deicer is lost due to the brine droplets raised by cars and trucks that are carried by the wind or that are collected by other vehicles. Such aspects might need a future development. One more aspect is to find a reliable

measurement tool to make a proper comparison between the numerical model and field data. So far, the only tool to build a deicer residual map is SOBO 20. Such a tool has shown limits as indicated in the literature (8). The last point would be to see if such a model could easily operate with water film thickness forecast and weather forecast.

RESULTS AND DISCUSSION

Ideal Case of Homogeneous Presence of Deicer

Though some data were available on real deicer patterns, some calculations were run considering the whole road stretch had the same initial amount of deicer, in the case of a 50-m long pavement section. Similar traffic and precipitations description were used. The deicer mass title after 1, 50, and 60 h are given on Figure 5, with the same color code as the one on Figure 4c.

As illustrated, the wheel tracks were clearly the zones where the risk of freezing appeared due to a decrease in the mass title of the brine. Furthermore, the liquid that could be stored next to the markings had induced several critical zones (in red on Figure 5c) where no protection left against freezing.

Evolution of Residual Deicer Applied by a Winter Maintenance Vehicle

As illustrated before, winter maintenance vehicles were hardly able to evenly apply deicer on a road stretch. Some heterogeneities appeared and would obviously be worsened by the traffic and the precipitations.

Influence of Traffic Parameters q_{cars} and q_{trucks}

Several calculations were undertaken with different values of q_{cars} and q_{trucks} . It was considered that the fraction for trucks was at least 10 times the one for cars. The objective was to establish the range within which some mass title variations were below 0.005.

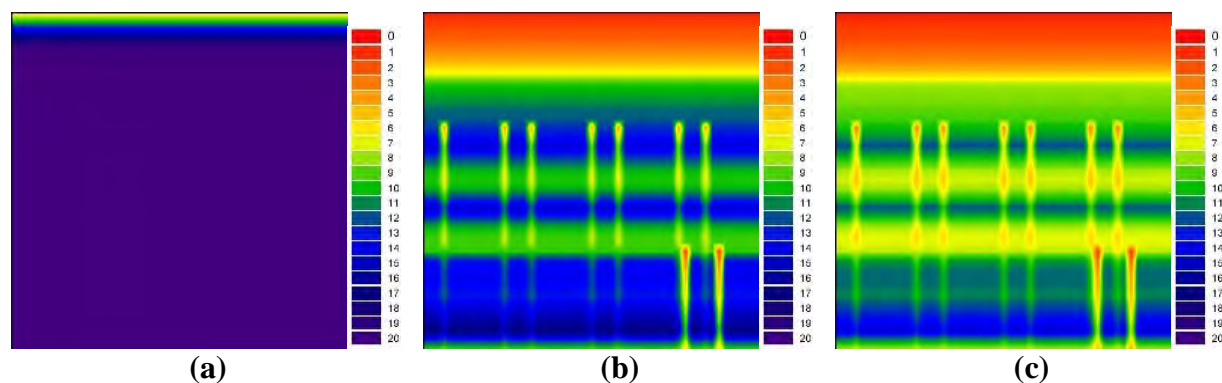

FIGURE 5 Evolution of the deicer mass title (in %) with traffic and precipitations after an ideal homogeneous presence of deicer on a road stretch: (a) 1 h after deicer spreading, (b) 50 h after deicer spreading, and (c) 60 h after deicer spreading.

TABLE 1 Range of q_{cars} q_{trucks} Parameters Tested

q_{cars}	q_{trucks}
0.000005	0.00005
0.00001	0.0001
0.00002	0.0003
0.00005	0.0006
0.00009	0.001
0.0003	0.004
0.001	0.01
0.005	0.01

The results indicated that values below ($q_{\text{cars}} = 0.00001$, $q_{\text{trucks}} = 0.0001$), the traffic did not have any effect, especially in the wheel tracks. Such a situation could not be maintained since the literature indicated traffic has a major impact on residual deicer patterns (3, 4, 7). Above values ($q_{\text{cars}} = 0.001$, $q_{\text{trucks}} = 0.01$), the effect of the traffic is such that there was no more deicer in the wheel tracks after a few hours. Such a result is not consistent with field data quoted by Blomqvist et al. (3). These parameters range had been clearly identified for the chosen description. It needed reliable field data to choose relevant and consistent values. These would only be representative of pavement nature. As a consequence, values might differ between concrete and asphalt.

Effect of Traffic on Transverse Profiles

The objective here was to establish a comparison between deicer mass title evolutions between each traffic lane, particularly in the wheel tracks. It would provide some interesting data on the freezing point of the brine on the surface, and where critical points might be located. The comparison presented here was obtained after 2,000 passing vehicles and 10 h after the deicer had been applied on the pavement. The calculations were run with ($q_{\text{cars}} = 0.00005$, $q_{\text{trucks}} = 0.0006$). On Figure 6 is given the deicer mass title as a function of distance to roadside for different hours after the deicer had been applied onto the pavement. The emergency lane, which represented the first 2.5 m, was maintained. Being not affected by traffic, it constituted a good reference of the sole effect of precipitations.

Some heterogeneities appeared between wheel tracks and the rest of the road. As time passed, the deicer mass title changed with the amount of water on the road: the greater the amount of water the lower the mass title deicer. The brine was then either more or less concentrated.

The residual deicer patterns are illustrated on Figure 7 for the same q_{cars} and q_{trucks} values, 18 h after the deicer had been applied. In the case of right lane, the average deicer title is 6% over the whole road section in the wheel track, and 10% outside of it. Some equivalent values were found in the left lane (respectively 9% and 10%). Such results were consistent with the fact that fewer trucks were present in the left lane.

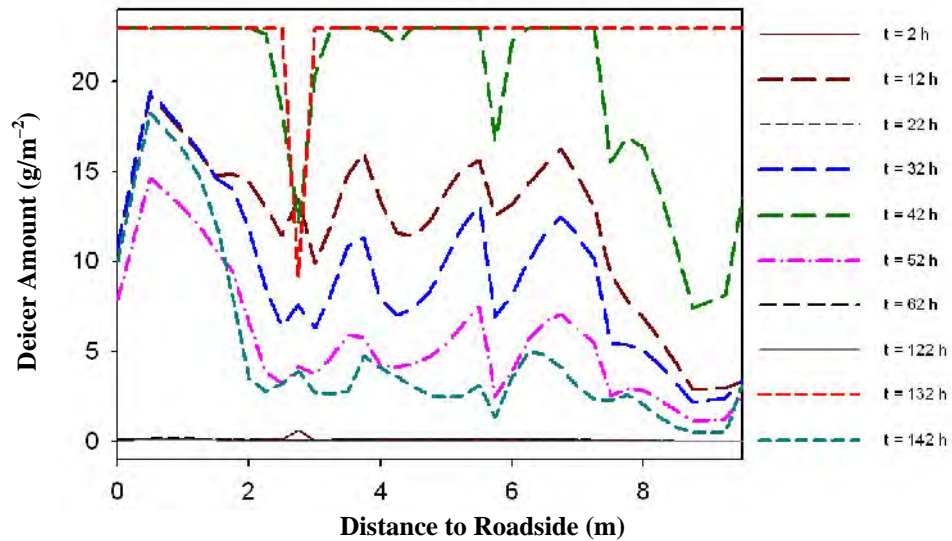

FIGURE 6 Transverse profiles of deicer amounts (in g/m^2).

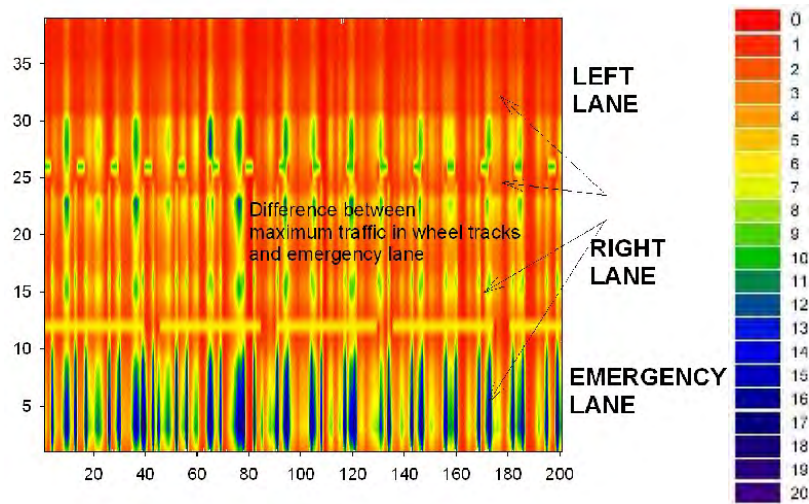

FIGURE 7 Deicer residual patterns after 18 h
($q_{\text{cars}} = 0.00005$, $q_{\text{trucks}} = 0.0006$).

Deicer Mass Title Patterns on the Road Stretch

As in the section on the ideal case of an homogeneous presence of deicer, some calculations were run with deicer heterogeneities as they appeared when the deicer is applied onto the pavement. Calculations were run for ($q_{\text{cars}} = 0.00001$, $q_{\text{trucks}} = 0.0001$), the traffic and precipitations profiles over time being still the same. Results from 8 to 13 h after the deicer application, with a 1-h step are given on Figure 8a-f.

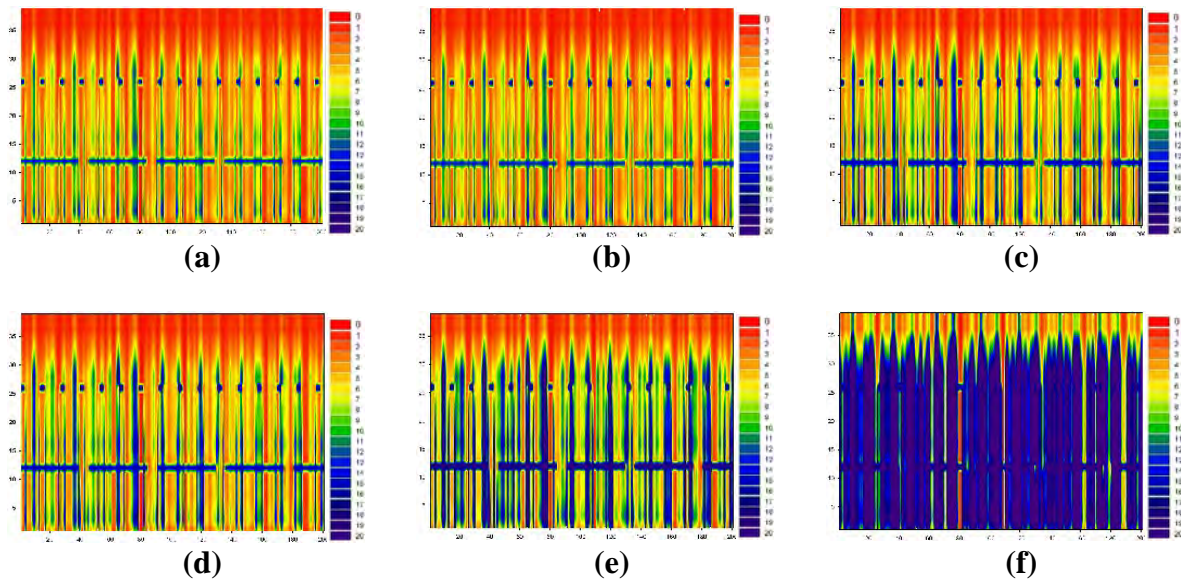

FIGURE 8 Evolution of the deicer mass title (in %) patterns with traffic and precipitations after an ideal homogeneous presence of deicer on a road stretch ($q_{\text{cars}} = 0.00001$, $q_{\text{trucks}} = 0.0001$).

Depending on the q_{cars} , q_{trucks} values, the wheel tracks could be more or less easily located. With such a description, and as indicated in the literature, to get an average deicer mass title over a road stretch did not really have any meaning. Great heterogeneities existed and persisted over time, especially where the run off due to markings took place. The risk of slipperiness could then exist on several spots

One interesting aspect is the fact that the brine got more concentrated after 13 h as the pavement dried. Indeed, since there were no more precipitations, the water has gradually evaporated, with still some deicer in less and less water. Such an analysis is obviously only valid as long as no deicer loss due to traffic is considered when dry deicer is left on the pavement.

CONCLUSION

A numerical model has been built to evaluate the effect of traffic and precipitations on the deicer mass title of brine on a pavement. The model could be applied to road stretches a few hundreds meters long, taking into account transversal slopes and markings. It used precipitation profiles and water film thicknesses established with the numerical model SISPAT to describe the water life cycle. Field traffic data, with trajectories distributions and a distinction between cars and trucks, was used. The model considered that each passing vehicle removed a fraction of deicer. The removal was obtained through two parameters, q_{cars} and q_{trucks} , which described the pavement roughness. The characteristics of the vehicles were taken into account too (tire size, axle width). Real deicer patterns from a winter maintenance vehicle were employed as the initial status.

The calculations have shown that wheel tracks were particularly affected by the traffic. According to the traffic intensity and precipitations, several critical zones with no deicer left

appeared. The life cycle of water on the pavement caused dilution of the deicer, which indicated some winter maintenance operations might be necessary. But as evaporation took place, the deicer mass title increased. Such events would tend to make additional salting operations not appropriate. Such an analysis could induce some savings and make winter maintenance more environmentally compliant.

REFERENCES

1. *Viabilité hivernale. Méthode française des objectifs de qualité. Pourquoi? Comment?* Document of Service des Etudes et Travaux des Routes et Autoroutes, undated (in French).
2. Kaufmann D. W. *Sodium Chloride: The Production and Properties of Salt and Brine*. Monograph 145. ISSN 0065-7719. American Chemical Society, Washington D.C., 1960.
3. Blomqvist, G., and M. Gustafsson. Patterns of Residual Salt on Road Surface: Case Study. *Transportation Research Circular E-C063: 6th International Symposium on Snow Removal and Ice Control Technology*, Transportation Research Board of the National Academies, Washington, D.C., 2004, pp. 602–608.
4. Gustafsson, M., and G. Blomqvist. Modeling Exposure of Roadside Environment to Airborne Salt. Case Study. *Transportation Research Circular E-C063: 6th International Symposium on Snow Removal and Ice Control Technology*, Transportation Research Board of the National Academies, Washington, D.C., 2004, pp. 296–306.
5. Hunt, C., G. F. Mitchell, and W. Richardson. Field Persistence of Anti-Icing Sodium Chloride Residuals. *Transportation Research Circular E-C063: 6th International Symposium on Snow Removal and Ice Control Technology*, Transportation Research Board of the National Academies, Washington, D.C., 2004, pp. 609–622.
6. SISPAT numerical model. www.lthe.hmg.inpg.fr/Sispat/sispat-fr.htm. Accessed on November 29, 2007.
7. Livet, J. *Evaluation de l'entraînement des fondants routiers par le trafic. Expérimentation RN 74*. Project “Météorologie routière” AER 1.90.03.4, publication 94/0013 (in French).
8. Raukola, T., R. Kuusela, H. Lappalainen, and A. Piirainen. Anti-Icing Activities in Finland: Field Tests with Liquid and Prewetted Chemicals. *Transportation Research Record 1387*, TRB, National Research Council, Washington, D.C., 1993, pp. 48–56.

Using Weather Information to Improve Traffic Safety

USING WEATHER INFORMATION TO IMPROVE TRAFFIC SAFETY

Comprehensive Winter Maintenance Management System to Increase Road Safety and Traffic Flow

THORSTEN CYPRA

Boschung Mechatronic AG

Major goals of road operations are safety, environmental protection, economics, and the necessary optimization of these issues in delivering quality winter maintenance services. For increasing road safety, the needs are high-quality prediction and sensor technologies as well as appropriate winter service treatments at the right time. Next to road safety, mobility is an important factor in local economies; uninterrupted traffic is a basic requirement. As a consequence, the standards of winter maintenance have become very high. Traffic flow and capacity on roadways under wintry road conditions were analyzed in actual research. With weather–road condition data and traffic data, the methodology of traffic flow analysis under defined wintry road conditions could be verified. Furthermore first results of capacity losses under defined wintry road conditions could be quantified. It was shown that with heavy snowfall, the capacity decreases more than 50%. These results clearly show the need for maintenance decision support systems (MDSS) to efficiently and safely manage infrastructure systems in wintertime. A solution to this is the management system BORRMA-web MDSS (Boschung Road and Runway Management). This system clearly displays all important elements in one view, such as dynamic maps, road weather stations, fixed automated spray technology, vehicle operation data and location of winter service vehicles, road conditions etc. for real-time, future, and past events. Especially useful is the combination of local measurements (roadway weather information system stations) and weather forecasts allowing detailed predictions and alerts for each forecasted road weather segment (road section with similar microclimatic conditions).

Generally major goals of road operations are safety, environmental protection, economics, and the necessary optimization of these issues in delivering quality winter maintenance services. Next to road safety, mobility is an important factor in local economies; uninterrupted traffic is a basic requirement for the effective development of the economy and society. The economy is increasingly more dependent on a road system that functions properly at all times. A significant increase in traffic volumes on roads has an effect on quality of traffic flow and safety. That means the aim of road management must be that a road user can drive a certain distance in a predictable time as safely and reliably in winter as in summer. As a consequence, the standards of winter maintenance for a road network have become very high. Therefore, winter maintenance must be organized optimally and operations have to be enacted extremely quickly. Because of the complexity of meteorological, traffic, and winter service processes, the persons in charge of winter maintenance need a comprehensive winter maintenance management system.

TRAFFIC FLOW AND CAPACITY OF HIGHWAYS UNDER WINTRY ROAD CONDITIONS

Cypra (2007) analyzed traffic flow and capacity on highways under wintry road conditions. After definition of certain wintry road conditions the data of roadway weather information systems (RWIS) stations (weather and road condition data) and nearby long-term stationed census points (traffic data) were analyzed. With additional winter maintenance reports the methodology of traffic flow analysis under defined wintry road conditions could be verified. Several highway cross sections in Germany were analyzed. It was possible by researching the average speed and statistical spread to identify relevant factors of influence in the field of traffic (e.g., heavy vehicle traffic proportion) and environment (e.g., longitudinal gradient, daylight) in relation to different wintry conditions. In addition traffic deadlocks caused by winter weather-related road blocks by heavy goods vehicles were checked.

Figure 1 shows an example of different traffic flow situations caused by road condition effects, no wintry road conditions, and snowfall of over 30 min. The research could show that the main factors of influence next to defined wintry weather events were longitudinal gradient, traffic volume, and amount of heavy traffic.

Furthermore first results of capacity losses under defined wintry road conditions could be quantified. In *Handbook for Design of Road Traffic Facilities* (in German: *Handbuch für die Bemessung von Straßenverkehrsanlagen*, HBS) (2001), capacity is defined as “the highest traffic density that a traffic stream can reach at its cross-section under the given road and traffic conditions.”

The capacity of highway cross sections depends on several ancillary conditions and is thus subject to wild, time-related fluctuations. The factors of influence can be divided into four different groups:

- Road conditions,
- Traffic conditions,
- Traffic control conditions, and
- Environment.

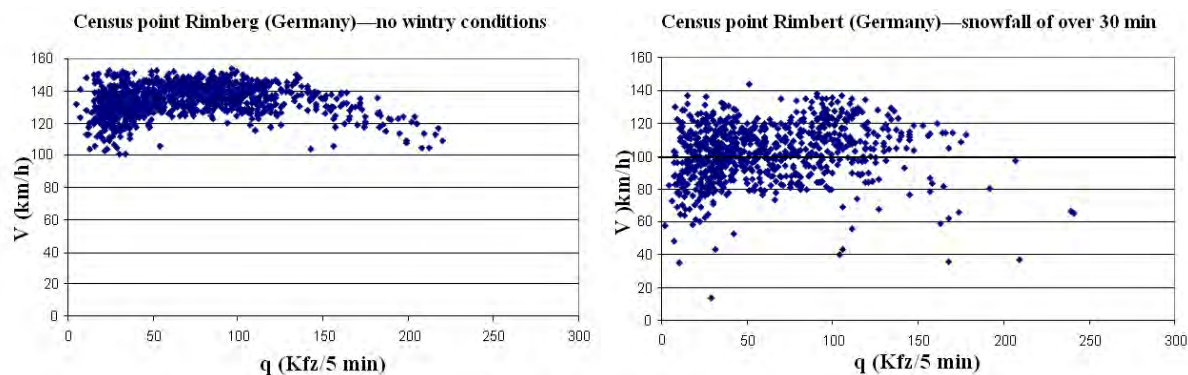

FIGURE 1 Example of different traffic flow situations caused by road condition effects

Environment factors are light, weather and road conditions. Wintry road conditions play a major role in influencing the traffic flow. For determining the capacity under wintry road conditions, basically the following data were used:

- Winter maintenance reports by the investigated highway surveillance centers,
- Additional reports for congestion registration,
- Details about the investigated road sections (longitudinal gradients, number of lanes, etc.),
- Data with differentiated density and velocity values obtained from census points and
- Accident reports.

After creation of a velocity–time variation curve that represents the exact time window of congestion, the data of the decisive time were analyzed. Then by using the density–velocity diagrams (d-v diagrams), the maximum traffic volume that corresponds to the capacity is determined for winter-related congestion (see Figure 2).

The analysis of winter-related traffic jams at measuring points saw a clear drop in capacity. For defined wintry road conditions, capacity losses could be quantified, but further measurements are necessary for more differentiated classification. An overview of capacity losses under defined wintry road conditions follows:

- | | |
|---|----------|
| 1. Light snowfalls, which can mainly be treated by salt spreading: | 10%–20 % |
| 2. Short-term, heavy snowfalls (<30 min),
short-term snow-covered road, snow plowing: | 30%–40% |
| 3. Heavy, long-term snowfalls, reduced visibility
snow-covered road, despite snow plowing: | >40% |

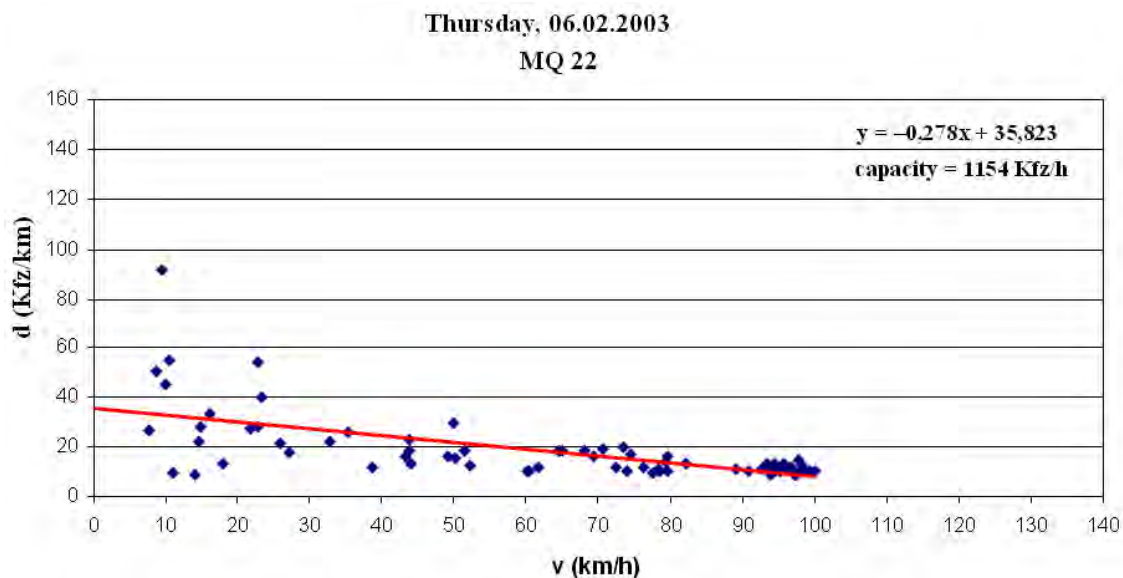

FIGURE 2 Example of a d-v diagram of a winter-related congestion—capacity determined.

With this knowledge of capacity losses, the load factor of a motorway section suggests when a motorway section will become overloaded in wintertime. The initial results of the reduction in capacity due to winter road conditions reveal the enormous importance of winter road service for high-volume motorways in particular. With the help of more differentiated knowledge of capacities under winter road conditions, there is the possibility of directing winter road maintenance in an even more effective manner especially on critical sections of road. There is the need of predictions at a small scale in combination with other information (traffic, winter service vehicles, RWIS station data, etc.) to prepare the winter service treatments optimally. Because of the complexity these results clearly show the need for maintenance decision support systems (MDSS) to efficiently and safely manage infrastructure systems in wintertime.

WINTER MAINTENANCE MANAGEMENT SYSTEM

Wintry road surface conditions have a considerable impact on road safety and traffic flows. Speed levels fall, distances between cars increase along with a reduction in traffic quality and capacity. This can result in reduced traction and reduced visibility when it is snowing right through to impassability. In turn, this results in a considerable cost to the economy due to winter-related accidents, as well as delays from reduced speeds and traffic jams.

According to the definition (2000) of the FGSV (Research Association for Roads and Transport) “winter maintenance” is “the totality of measures of the roads’ operator for maintenance and easing of traffic as well as road safety during wintry conditions.” There is no doubt that the highest priority is the guarantee of road safety. In addition, the maintenance of the traffic flow is of great importance. This can be shown by the fact the mobility is now a key location factor and that free-flowing traffic is a key condition for the ongoing development of a functioning economy and society. There is also the increased demand for correct but economic road operation. These targets apply to both highways and urban roads.

Competent road condition and weather monitoring and the resulting qualified launching and control of winter maintenance deployments allow an optimized, high-quality winter maintenance. However, complex decision-making situations, such as those in winter maintenance management, require support systems to employ the best possible measures according to the prevailing general conditions. A characteristic of winter maintenance of road operations is that the winter maintenance service can usually respond to the effects of the weather only through timely winter maintenance measures; there is no option, as with much of the summer maintenance—building site management, of carrying out preparatory work in a way which is flexible but takes adjusted requirements into account. Nevertheless, the influencing factors and interaction of the factors, which can lead to critical situations, can be analyzed and can thus be processed in an intelligent management system to create detailed prognoses with high probabilities to support decision making for efficient winter maintenance measures.

BORRMA-web MDSS inside

It is here that the BORRMA-web MDSS inside management system, developed by Boschung Mecatronic AG, can help by offering a web-based network solution with numerous functions for

the management of roads and runways. (“BORRMA” stands for “BOschung Road and Runway Management.”) Special prognoses for the RWIS station data and road conditions along with a clear visualization of all the key information support the winter maintenance manager in making decisions and controlling the winter maintenance deployments. MDSS inside can assist in taking these decisions.

BORRMA-web MDSS inside is the central component of the complete surface condition management (SCM) by Boschung, which can offer communities, towns, road construction authorities, and airports the option of integrating and networking all their stationary and mobile systems to provide efficient coordination and control of their summer and winter maintenance programmes (Figure 3).

BORRMA-web MDSS inside is a comprehensive winter maintenance management system to monitor the current and expected road conditions, to control deployments, and to automatically record and display all data and reports (proof of the road safety obligation and performance data recording of the deployment vehicles for balances and invoicing). The new features of this software are, on the one hand, the intelligent linking of weather information and periodic road condition data and prognoses from RWIS stations (GFS 3000), taking local general conditions into account, giving road condition predictions not just for local points but for whole roads sections, so-called road weather segments. On the other hand, a management system has been created so that the user receives a large volume of information presented clearly, e.g., RWIS station data, visualized road condition prognoses, RWIS reports, status of the fixed automated spray technology (FAST), location and activities of winter service vehicles, on one user desktop.

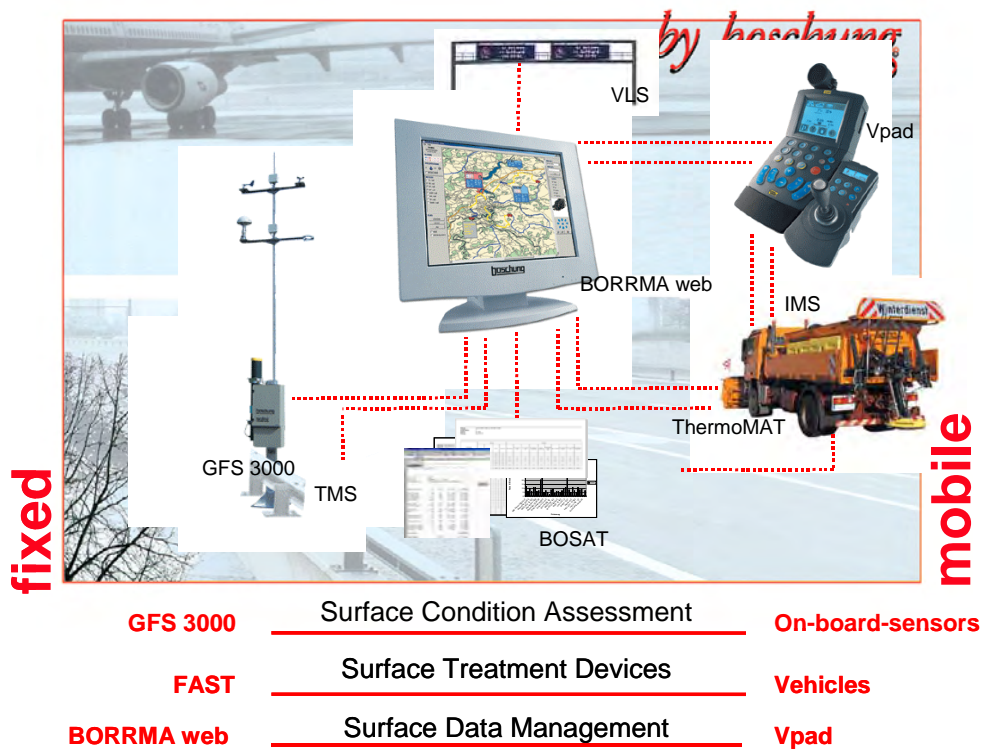

FIGURE 3 SCM.

The following overview shows the functional principle of BORRMA-web MDSS inside together with the key input parameters and data flow, which the system uses to prepare the appropriate prognoses, centralized databases, and visualized information. In addition, Boschung uses open source components. The user does not need to install any special software, but can access the server functions directly. The system is also freely scalable; that is, the hardware is adapted individually according to requirements and size (community, city, state). Hosting is also possible in various areas, for example, the vehicle performance data recording; that is data are managed using a secure Internet portal, and no system investments are required (Figure 4).

LOCAL AND ROUTE-RELATED ROAD CONDITION PREDICTIONS

For the winter maintenance manager, it is important to know early when and which points in the road network under their control are subject to wintry road conditions. Only in this way is it possible for them to coordinate the resources available to them and decide about the deployment time, type, and scope.

Besides the weather reports and the RWIS prognoses, the data and predictions of the RWIS stations are of high importance for the launching and control of winter maintenance

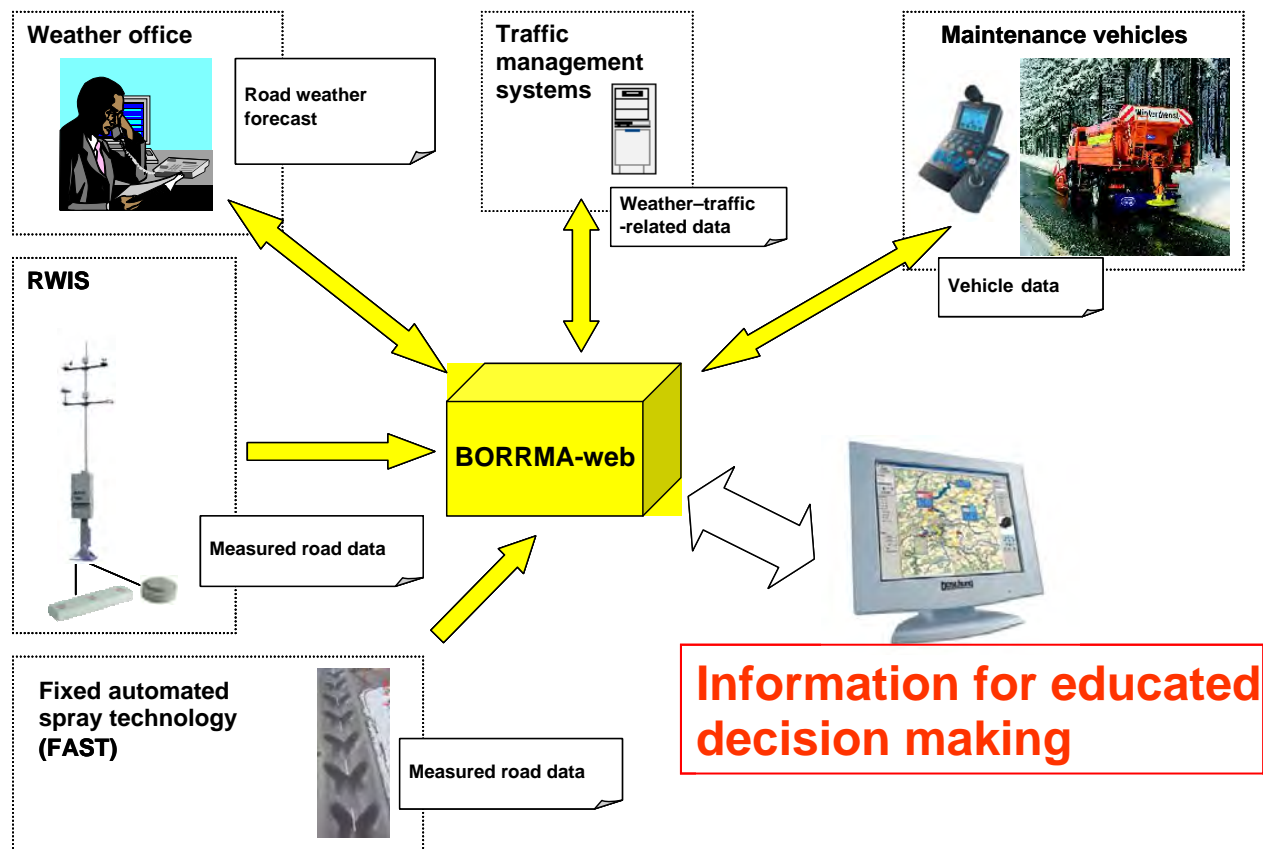

FIGURE 4 Functional principle of BORRMA-web MDSS inside.

activities. On the dynamic map, the winter maintenance manager can, for example, see all the RWIS stations as flags, and is informed of expected dangers by an alert.

Several steps must be run through for a route-related road condition process. The network under observation is divided into sections according to meteorological criteria, so that similar microclimatic conditions can be found within these segments. Within BORRMA-web MDSS inside, these sections are called road weather segments.

By using the measurements of the local RWIS stations, detailed weather forecasts and precipitation forecasts (precipitation radar), local forecasts are calculated in a nowcasting. These local forecasts usually relate to the RWIS stations. This nowcasting is calculated for the next two hours and is updated regularly. When controlling winter maintenance activities, it is these 2 or 3 h that are decisive for the correct selection and scope of winter maintenance deployments. The measured and expected parameters for the RWIS stations can be viewed in a separate window (Figure 5).

In the area of measuring points, the user can now use specific parameters to detect exactly when, for example, this area can expect ice. The reliability of the measuring point prognoses for road conditions is increased yet further by an active sensor technologies. For this, a road surface sensor is cooled in stages at regular intervals until ice formation is determined on the sensor surface. This means that a freezing point temperature is not calculated from resistance measurements but is measured (increased accuracy). This active technology is particularly advantageous for forecasting frost.

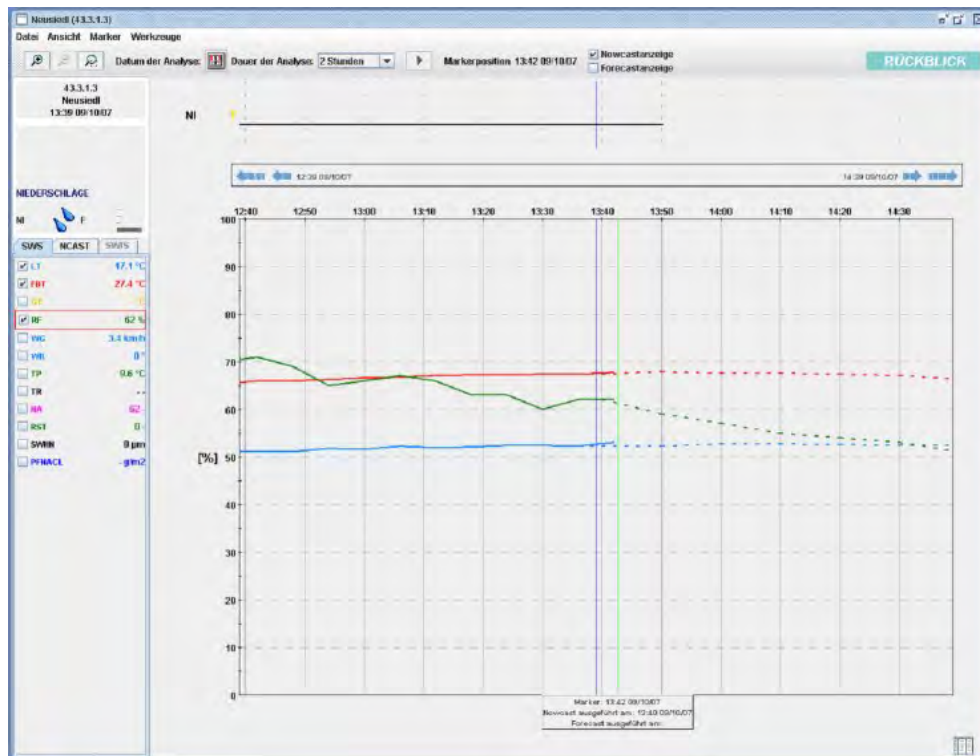

FIGURE 5 Measured and forecast data for an RWIS station.

Using the local prognosis, the forecast function is used to calculate a long-term (3-day), route-related prediction. This forecast is based on the results of the nowcasting, long-term weather forecasts and additional general conditions. Risk levels are determined for time periods for each road weather segment by using innovative decision-making methods. These risk levels are then displayed on the dynamic map for each road weather segment according to time. Each time a road weather segment is clicked, the individual risk levels (no risk, risk level 1 to 4) are displayed at the bottom right of the user desktop along with the time of occurrence. This gives the road maintenance manager an overview of the current status of their entire road network and, using a time slider, of the forecast road surface states. Besides the road surface conditions, it is also possible to display the air temperature or road surface temperature for all the road weather segments on the map.

This gives winter maintenance managers a tool with which they can control the winter maintenance deployments efficiently and plan the optimum personnel and vehicle requirements for a longer period of time (Figure 6).

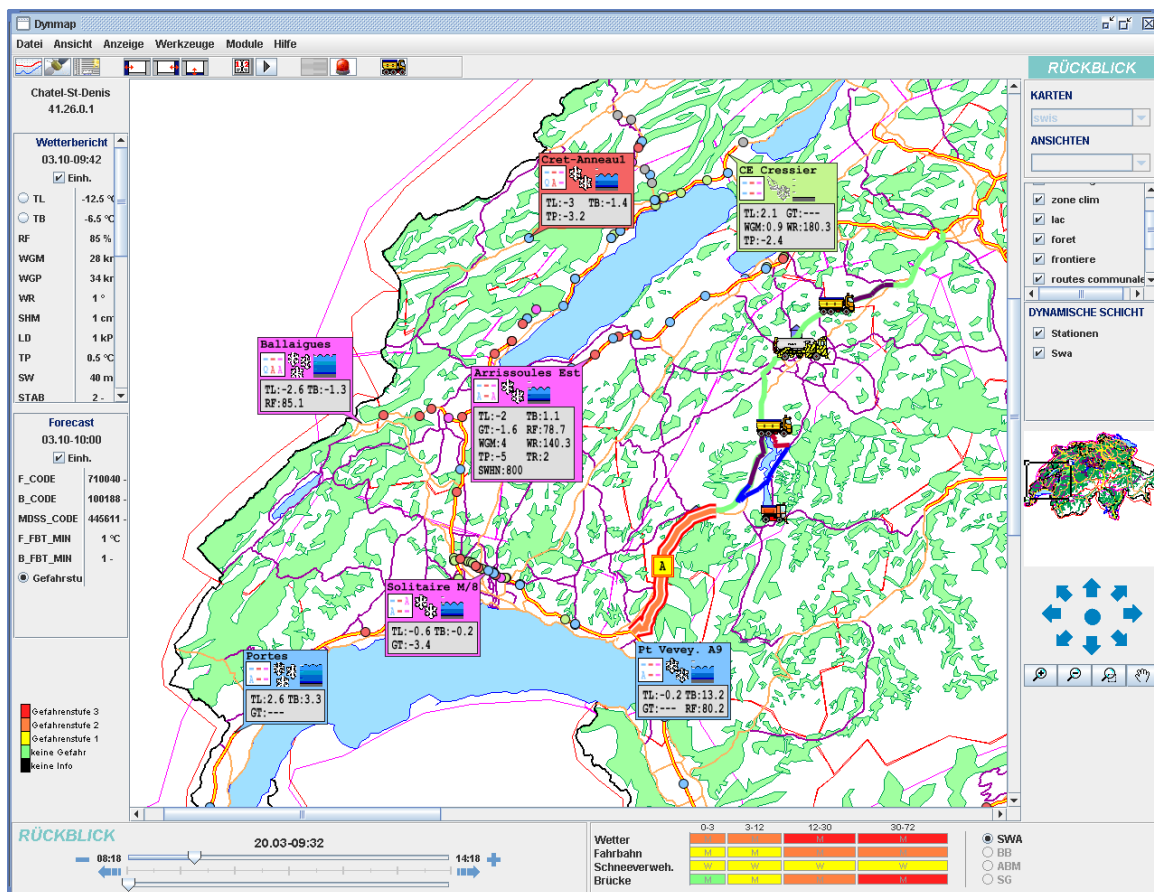

FIGURE 6 BORRMA-web MDSS inside desktop.

DYNAMIC MAP

When planning and controlling winter maintenance activities, the winter maintenance manager has to observe numerous general conditions and influencing parameters, such as legal regulations and requirements, meteorological parameters and weather developments, current and future road conditions, traffic factors, and resources, and include them in the decision-making process. In particular, in the case of winter events such as heavy snowfalls or rapid icing, it is essential that the winter maintenance manager is supported by a visualization of the deployment-relevant information, prognoses and alerts, on account of the complexity of the operation.

The dynamic map consists of a static background, calibrated according to Global Positioning System (GPS) coordinates (vectorial map, satellite images, etc.) and various dynamic information layers (road weather segments, RWIS stations, vehicles, FAST, etc.) which are superimposed upon it. RWIS stations are shown as small flags, in which the parameters can be configured individually. The dynamic segment is continually updated to show the latest data. Alerts from the RWIS stations or expected risks on the road weather segments are clearly shown on the dynamic map, by the appropriate road or measuring point flag changing color (Figure 7).

Installed FAST can also be monitored and controlled from the dynamic map by using a special deicer spraying synoptic. In so doing, the user can follow the course of the spraying programme (control of the individual valves, spraying operation of the individual spraying profiles, flow measurements, tank levels, etc.) in detail on the screen. When failures occur, the defective system parts are colored, so that the visual localization of the fault can speed up elimination (Figure 8).



FIGURE 7 Example of the display of a measuring point flag and deployment vehicle with current data on the dynamic map.

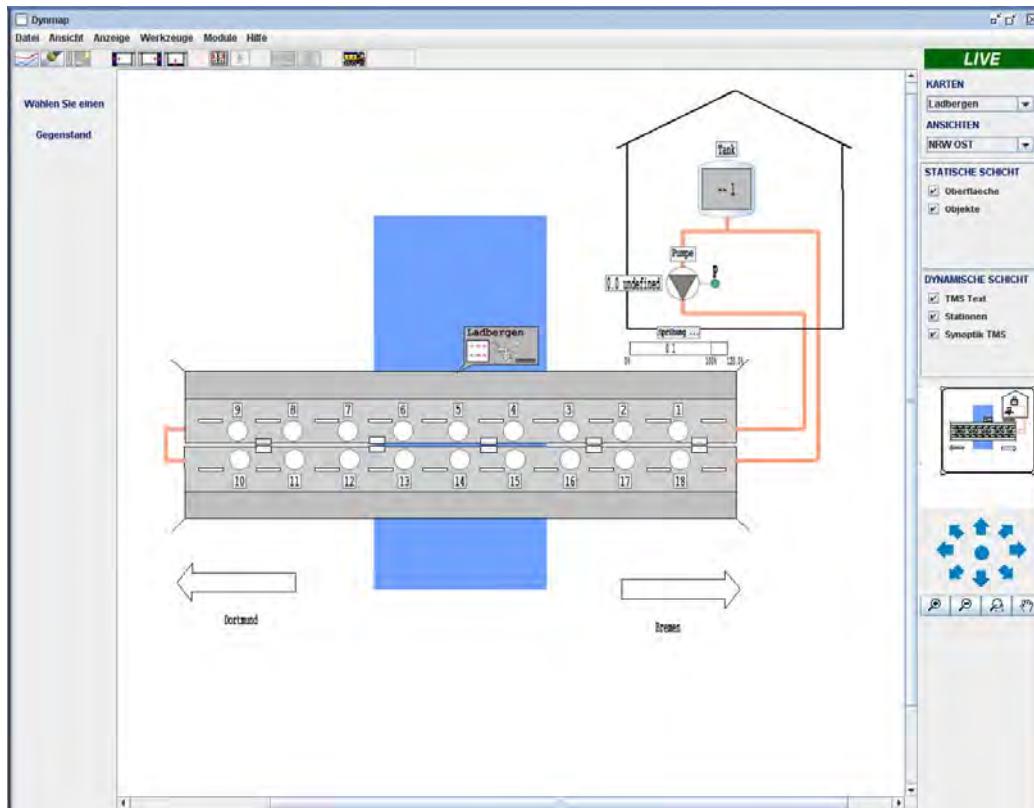

FIGURE 8 Example of deicer spraying synoptic to control and monitor a FAST system.

VEHICLE DATA MANAGEMENT

Because of the obligation to prove regular analyses and evaluation and also for invoicing purposes, all the winter maintenance activities must be documented fully and clearly. For this, the drivers of the winter maintenance vehicles, among others, create winter service reports, which contain the clearing and salting route, with times, the type of deployment, if necessary making distinctions of route areas, the quantities of salt usage and loading, as well as the environment conditions (weather, road surface conditions, etc.), to prove the correct fulfilment of the duties and to counter any liability claims. Often, the winter maintenance operators must provide reports; e.g., road and motorway maintenance authorities must report to the state operators or municipal operators must report to local government (Durth and Hanke, 2004).

Automatic data recording of the winter maintenance deployments as part of vehicle management can be used to create complete documentation without any manual effort. This is even more important in order to meet the growing requirements for fast, functioning, and economic winter maintenance as part of a comprehensive winter maintenance management system (Figure 9).

The performance data recording makes a distinction between summer and winter maintenance. The deployment data are recorded for a range of units with GPS locations in the Vpad. The Vpad is a control panel for the winter maintenance vehicle and is also used to record and transmit data. Data transmission takes place online via short message service or as a file via general packet radio services during the deployment in defined time periods (e.g., 60 s, 2 min) or

offline, after the deployment, in the database of BORRMA-web MDSS inside. The master data must be entered or simply confirmed on starting the trip, and data transmission takes place without any manual input. With the online communication, the deployment data and vehicle positions can be followed on the dynamic map during the course of the deployment, which provides benefits for dynamic route planning, changing of deployment focus, etc. (Figure 10).



FIGURE 9 Winter maintenance vehicle on highway.



FIGURE 10 Control panel to control gritters and snowplows with integrated data recording and route guidance.

Then, the data in the database can be evaluated easily to prove the fulfilment of the obligation to road safety, to invoice contractors, to create balances and statistics; this, among other things, considerably reduces the amount of administrative work. The summary and detailed reports are freely configurable. This means that event lists, deployment lists, and deployment reports can be created for any time period. The deployment reports can also be sorted by road name, road category, zone, or task. Figure 11 shows an example of an event list report. All the reports and logs can be exported into various formats (PDF, XML, HTML, CSV) for further processing. This also provides the option of automated invoice generation.

Intervention	20.03.2007 06:53:54	Agent		Vehicle	320 Vogel		Salt
Intervention	20.03.2007 09:10:14			Vehicle plate	LU974		
Duration	2:16:20			Center	Kt Luzern		
Tools	320 Salzstreuer						
Sensors							

Vehicle and tool				Spreading			
Time / Number		Distance		Quantity		Distance	
320 Vogel	2:16:20	71.73	[km]	Salt	1751.16	[kg]	49.90
320 Salzstreuer	1:18:29	49.92	[km]				

Event	Status	Hour	Dist. [km]	Road	Road category	PK	Speed [km/h]	Spreading						
								Width [m]	Density Subproduct1 [g/m ²]	Dist. Subproduct1 [km]	Quantity Subproduct1 [kg]	Asymmetry	Spread program	
	+	06:53:54	0		0	0.0	0							
JOE2468	+	06:53:54	0		0	0.0	0							
320 Salzstreuer	+	06:54:25	0.00		0	0.0	2	3	10	0	0	0.0	0	
		06:55:25	0.00		0	0.0	2	3	10	0.02	0.78	0.0	0	
Streustraße 320	*	06:55:29	0.03		2	0.0	1							
	*	06:55:29	0.03		2	0.0	1							
	*	06:55:59	0.10	Streustraße 320	2	-1.0	11							
		07:02:16	3.76	Streustraße 320	2	-1.0	51	4	10	3.79	113.84	0.0	0	
		07:02:17	3.79	Streustraße 320	2	-1.0	102	4.5	10	3.80	114.28	0.0	0	
		07:02:18	3.82	Streustraße 320	2	-1.0	0	5.5	10	3.82	115.16	0.0	0	
		07:02:19	3.82	Streustraße 320	2	-1.0	0	6.5	10	3.83	115.88	0.0	0	
	*	07:02:23	3.82	Streustraße 320	2	-1.0	0							
		07:02:41	4.11	Streustraße 320	2	-1.0	43	6	10	4.12	134.86	0.0	0	
		07:02:42	4.14	Streustraße 320	2	-1.0	11	5	10	4.14	135.66	0.0	0	
		07:02:43	4.14	Streustraße 320	2	-1.0	5	4.5	10	4.14	136.11	0.0	0	
		07:02:44	4.14	Streustraße 320	2	-1.0	5	3.5	10	4.16	136.83	0.0	0	
	*	07:04:17	5.27	Streustraße 320	2	-1.0	58							
		07:05:10	5.55	Streustraße 320	2	-1.0	56	4.5	10	5.55	185.48	0.0	0	
		07:05:11	5.57	Streustraße 320	2	-1.0	74	5	10	5.55	185.48	0.0	0	
		07:05:21	5.68	Streustraße 320	2	-1.0	43	4	10	5.69	192.43	0.0	0	
		07:05:22	5.70	Streustraße 320	2	-1.0	65	3.5	10	5.71	192.99	0.0	0	
		07:06:23	6.45	Streustraße 320	2	-1.0	43	4.5	10	6.47	219.64	0.0	0	
	*	07:06:23	6.48	Streustraße 320	2	-1.0	86	5	10	6.47	219.82	0.0	0	
		07:06:25	6.49	Streustraße 320	2	-1.0	10	5.5	10	6.50	221.17	0.0	0	
		07:06:26	6.49	Streustraße 320	2	-1.0	9	6	10	6.51	221.72	0.0	0	

FIGURE 11 Example of an event list report.

CONCLUSION

Complex decision-making situations, such as those that occur in winter maintenance management, require supporting systems to detect dangerous road conditions and winter events early enough to plan and control road maintenance properly. But a differentiated knowledge about traffic flows and capacities under wintry road conditions and prediction of weather events and road conditions are necessary to organize an efficient, fast winter service. In the field of winter maintenance, BORRMA-web MDSS inside is a comprehensive management system to monitor the weather and road conditions and control and log the winter maintenance measures.

REFERENCES

- Cypra, T. Entwicklung einer Entscheidungsmethode für Maßnahmen im Winterdienst auf hochbelasteten Bundesautobahnen (Development of a decision method for winter maintenance measures on heavily travelled motorways). Doctoral thesis published in Veröffentlichungen des Instituts für Straßen- und Eisenbahnwesen der Universität Karlsruhe (TH), Heft 56, Karlsruhe (Germany) 2007.
- Durth, W., and H. Hanke. Handbuch Straßenwinterdienst (Handbook of winter maintenance), Kirschbaum Verlag, Bonn, 2004.
- Forschungsgesellschaft für Straßen- und Verkehrswesen (English, German Road and Traffic Research Association). *Handbuch für die Bemessung von Straßenverkehrsanlagen (HBS)* (Handbook for design of road traffic facilities) Cologne (Germany), 2001.
- Forschungsgesellschaft für Straßen- und Verkehrswesen, Begriffsbestimmungen, Teil: Verkehrsplanung, Straßenentwurf und Straßenbetrieb, Köln, 2000.

USING WEATHER INFORMATION TO IMPROVE TRAFFIC SAFETY

Advanced Road Safety and Weather Warning System**PAUL G. KNIGHT****JONATHAN AGUERO-VALVERDE****PAUL P. JOVANIS***Pennsylvania State University*

The FHWA has been seeking to better integrate the use of surface weather information into traffic operations (e.g., National Academy of Sciences, 2004). One area of particular interest has been the use of enhanced weather information and forecasting to improve response to winter road maintenance demands (e.g., Mahoney, 2003; Boon and Cluett, 2002). There has also been interest in user perception of web-based roadway weather information system (RWIS) information for use by the general public for trip planning (e.g., Fayish and Jovanis, 2004; Fayish et al., 2005). Travelers in central Pennsylvania have expressed an interest in using RWIS information for trip planning if the relevant websites are readily accessible (Fayish and Jovanis, 2004; Fayish et al., 2005).

One of the most promising potential benefits of RWIS is the provision of information about adverse weather to travelers so that crashes may be reduced. Previous research has shown relationships between weather conditions and crash risk (Eisenberg and Warner, 2005; Marmor and Marmor, 2006; Zhang et al., 2005). This project seeks to identify sites with elevated weather-related crash risk, using historical crash and traffic information for Pennsylvania. Pennsylvania Department of Transportation (PennDOT) has expressed an interest in using the identified sites as part of a system of highway advisory radio (HAR) websites and changeable message signs (CMS) to warn travelers of potentially significant storms in their area (ARSAWWS, 2005). Weather-related crashes are a particular challenge for central Pennsylvania. Between 1997 and 2004, approximately 40% of all reportable crashes in the region occurred under adverse weather conditions; those crashes accounted for more than 50% of all fatal and injury crashes.

PROBLEM STATEMENT

This paper describes the outcome of a project that built a crash and weather system database for use in a prototype weather early warning system for roadway managers and motorists within PennDOT District 2-0. The system is based on analysis of past crashes in the region along with historical records of significant weather events. Historical records of crashes in the region were searched from PennDOT files to systematically identify locations of high weather-related crash risk. The safety analysis was conducted using crash data from 1997 through 2004, excluding 2002. The final output of the project was the determination of areas and travel corridors that should be considered to be served by weather-based warnings as part of the traveler information system planned for District 2-0 ITS deployment. Once the crash locations were identified, meteorology staff at Pennsylvania State University searched background weather data (using

gridded data fields) for those dates and times to determine the predictability of the weather events in the District 2-0 region.

While the specific findings of this particular study are applicable to PennDOT District 2-0, the methodology is applicable to any other PennDOT district with comparable data.

DATA DESCRIPTION

The area of study was PennDOT Engineering District 2-0, which includes the counties of Cameron, Centre, Clearfield, Clinton, Elk, Juniata, McKean, Mifflin, and Potter, covering the north-central part of the state. A total of 5,001 linear miles of state-maintained roads were reported in District 2-0 in 2004. [Figure 1](#) presents the study region as well as the state-maintained roads included in the analysis.

A relational database was assembled with information from three different data sources: crash data, road inventory, and traffic data. All data were collected for calendar years 1997–2001 and 2003–2004. Crash data for year 2002 were missing due to changes in the Pennsylvania Crash Reporting System during that year; therefore, 2002 was omitted from the analysis. Once the database was assembled, road segments were divided into the four analysis groups:

1. Two-lane rural road segments,
2. Two-lane urban road segments,
3. Multilane rural road segments, and
4. Multilane urban road segments.

Crash Data

Crash data were obtained from the PennDOT Crash Reporting System. The data include reportable crashes for road segment and intersection locations (i.e., those that do not occur at a ramp junction). Road segments were given priority because of the ready availability of traffic and roadway information; data were not consistently available for ramps and intersections, particularly those intersecting non-state highways. Analyses of intersection crashes were completed for those intersections of state highways. The data include state roads only and do not include Pennsylvania Turnpike crashes.

For this research, weather-related crashes are defined as those crashes occurring under adverse weather conditions or when the road surface was wet or covered with snow, ice, or water. A special location code was created for each crash by concatenating the county, route, and segment numbers in a single variable. This created unique location identification for each road segment. Then weather-related crashes were summarized by location code and year.

Roadway Inventory Data

Roadway data were obtained from the Pennsylvania Road Management System (RMS). RMS includes data for each road segment such as county number, state route number, segment number, segment length, average daily traffic, pavement width, travel lane count, posted speed limit, divisor type, and urban–rural code. These data were complemented with the state roads digital map from Pennsylvania Spatial Data Access (PASDA) (Pennsylvania Spatial Data Access, 2005)

to be able to “map” crash locations. In the case of divided highways, each direction of traffic was considered an individual segment in the road inventory and this convention was maintained in the analysis.

Traffic Data

Since the road inventory contains average annual daily traffic (AADT) data by segment from the latest year, it was necessary to obtain the historical AADT for each study segment from a different source. The historical AADT data came from the Pennsylvania State Highway Performance Monitoring System (HPMS) database. For divided highways, the AADT is reported for the two directions of traffic in HPMS. Since segments in each direction are being analyzed separately, an adjustment was made to assign the corresponding proportion of traffic to each direction based on the directional split in 2004 that was recorded in the road inventory database. Table 1 summarizes descriptive statistics of the variables included in the models.

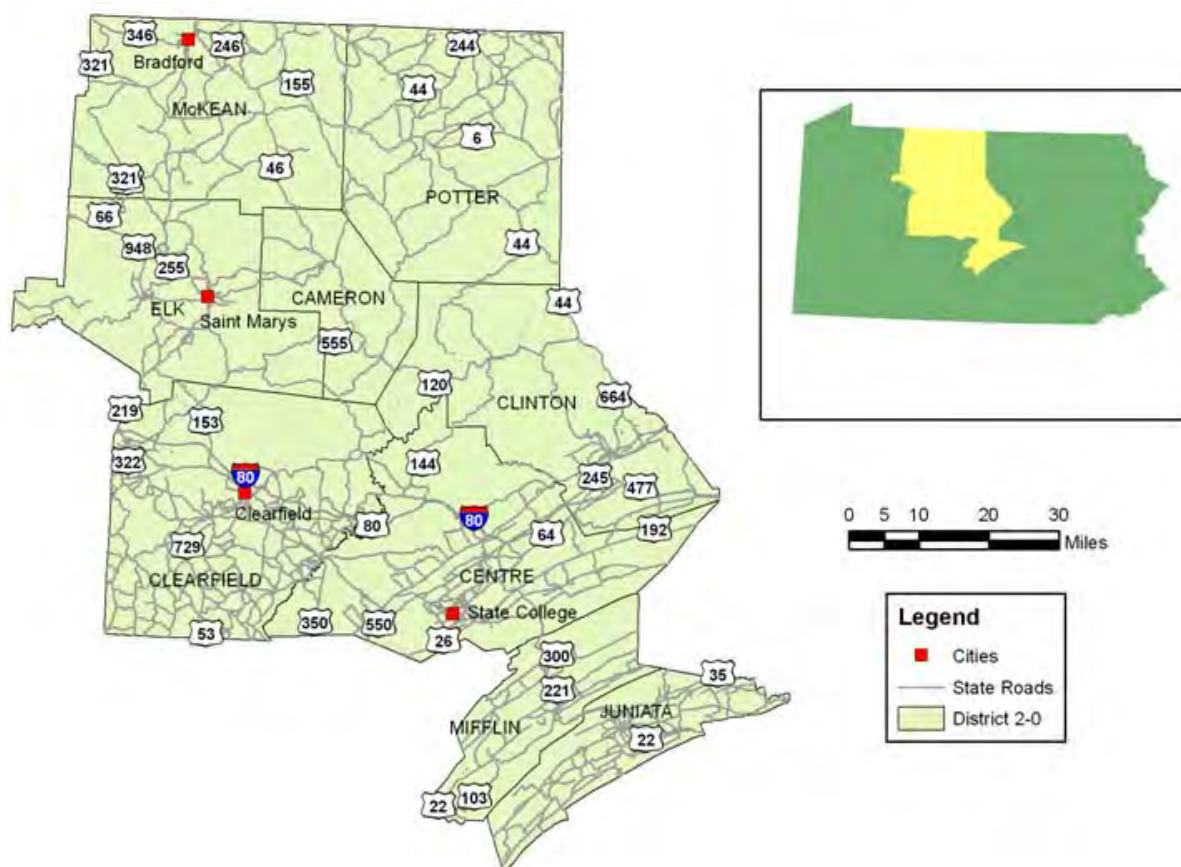

FIGURE 1 Area of study.

TABLE 1 Summary Statistics of Variables Included in Road Segment Models

Road Type	No. of Segments	Variable	Min.	Median	Mean	Max.	Stand. Dev.
Urban two-lane	560	Crashes	0	0	0.1949	5	0.50
		AADT	107	4,676	5,932	24,083	4,953.25
		Length (ft)	106	2,301	2,110	4,370	869.68
Urban multilane	251	Crashes	0	0	0.2408	5	0.59
		AADT	1,359	8,119	8,597	22,675	3,883.36
		Length (ft)	254	2,393	2,163	3,914	852.32
Rural two-lane	6,256	Crashes	0	0	0.1010	7	0.35
		AADT	39	786	1,722	21,059	2,315.81
		Length (ft)	135	2,509	2,467	3,992	616.31
Rural multilane	621	Crashes	0	0	0.3324	8	0.71
		AADT	661	9,875	9,329	2,9536	3,471.37
		Length (ft)	234	2,630	2,503	3,907	458.50

Extensive checks and verification were completed for the traffic data used in the analysis. Several telephone calls and communications were necessary before adequate data were available for the research. Care was taken to review road segments with short lengths and low AADT; discussions with PennDOT verified the accuracy of these values.

METHODOLOGY

Crash Analysis Background

The identification of high-risk sites is also known in the literature as the identification of sites with promise (Hauer, 1996). In the particular case of this study, the engineering safety improvement proposed is the installation of an advanced weather warning system; therefore, the crash type of interest was weather-related accidents and full Bayes (FB) hierarchical models were used to identify road segments for possible installation of the system.

In the Bayesian statistical framework, conclusions about parameters or unobserved data are made in terms of probability statements (Gelman et al., 2003). These probability statements are conditional in the observed quantities (the data, both dependent variables and covariates) and any prior knowledge on the model parameters. Therefore, Bayesian inference is based on the posterior distribution of the parameters of interest, given the data and the prior information on these parameters. In general, methods for summarizing posterior distributions are divided into two categories: empirical Bayes (EB) and FB (Lawson et al., 2003). Within the FB category, posterior sampling has become very popular due to the advances in Markov chain Monte Carlo methods.

Bayesian inference has a number of advantages over traditional statistical methods. Among them the Bayes method provides confidence (credible) intervals that are more in line with common-sense interpretations (Congdon, 2003). It also provides a way of including prior knowledge into the analysis in the form of prior distributions of parameters. Another advantage is the ease with which the true parameter density (possibly skew or even multimodal) can be

obtained (Congdon, 2003). In contrast, maximum likelihood estimates rely on asymptotic-normality assumptions that might produce imprecise estimates under small sample sizes. Bayesian methods also assist in the application of random effects models for pooling strength across sets of related units. This “borrowing strength” improves parameter estimation in sparse data such as small area estimates (i.e., crash frequency models), especially when large variability between analysis units makes it difficult to distinguish chance variability from actual differences in the estimates. This is the main reason why several authors have been encouraging the use of FB models with random effects on traffic safety (Tunaru, 1999; Miaou and Lord, 2003; Lord et al., 2005; Miaou and Song, 2005; Aguero-Valverde and Jovanis, 2005). FB models take full account of the uncertainty associated with parameter estimates and provide exact measures of uncertainty on the posterior distributions of these parameters, hence presenting an advantage over maximum likelihood and EB methods that typically ignore this uncertainty (Rao, 2003). As a result, maximum likelihood and EB estimates tend to overestimate precision.

EB methods for estimation of unsafe sites were proposed as early as 1981 (Abbess et al., 1981). These methods are frequently used to correct for regression-to-the-mean bias (Hauer et al., 2002). EB methods for ranking of sites by expected accident frequency as well as expected excess accident frequency have been used in several studies (e.g., Persaud et al., 1999; Heydecker and Wu, 2001; Hauer et al., 2004; Miranda-Moreno et al., 2005). The expected excess accident frequency is commonly referred as Potential for safety improvement (Persaud et al., 1999) or potential for accident reduction (Heydecker and Wu, 2001) and is defined as the difference between the expected crash frequency in the site and the expected crash frequency in a group of similar sites. When the expected excess accident frequency is used, sites with significantly more crashes than what is normal at similar sites are believed to have some site-specific attributes that contribute to that excess (Hauer et al., 2002).

FB hierarchical models have been used for ranking of sites only in a paper that used two different ranking criteria: ranking by probability that the site is the worst and ranking by posterior distribution of ranks (Tunaru, 2002). Others have suggested the additional concept of the decision parameter, which is site-specific and can include traffic flow, covariates, space and time effects, as well as random effects (Miaou and Song, 2005).

Modeling Approach

Consider the number of weather-related crashes at the i th segment and t th time period, Y_{it} , to be a random variable, which is Poisson and independently distributed when conditional on its mean μ_{it} :

$$Y_{it} \Big| \mu_{it} \stackrel{\text{ind}}{\sim} \text{Pois}(\mu_{it}) \quad (1)$$

The expected number of crashes in a site can be defined as the product of the exposure to the risk and the risk of a motor-vehicle crash as follows:

$$\mu_{it} = \eta_{it} \rho_i \quad (2)$$

where

μ_{it} = the expected number of crashes at segment i and time period t ,

η_{it} = the exposure function at segment i and time period t , and

ρ_i = the normalized crash rate or expected crash risk by unit of exposure at segment i .

The exposure or safety performance function (29) is defined as

$$\eta_{it} = V_{it}^{\beta_V} L_{it}^{\beta_L} \quad (3)$$

where

V_{it} = the AADT of segment i ,

L_{it} = the length of segment i , and

β_V, β_L = parameters of the model. The risk is defined as

$$\rho_i = \exp(\alpha + v_i) \quad (4)$$

where α is a constant and v_i is an unstructured random effect for segment i with a normal prior distribution with mean = 0 and variance = σ_v^2 .

Since FB models were used, v_i and therefore ρ_i were estimated for weather-related crashes for the four different types of segments under study. Unobserved effects can be captured by v_i , therefore reflecting individual differences between segments. The risk ρ_i can be expressed as the product of the exponents of α and v_i where $\exp(\alpha)$ can be thought of as the mean risk for all the segments under analysis and $\exp(v_i)$ can be considered a measure of the relative risk for each segment compared with the expected risk for all the segments of this type:

$$RR_i = \exp(v_i) \quad (5)$$

The full posterior distribution of v_i is estimated in the FB analysis; consequently, the credible set (confidence interval) for the relative risk is estimated.

The excess crash frequency can also be estimated using random effects. The excess crash frequency, δ_{it} , is defined as the difference between the expected crash frequency on segment i at time t and the expected crash frequency of a group of similar sites:

$$\delta_{it} = \eta_{it} \exp(\alpha + v_i) - \eta_{it} \exp(\alpha) \quad (6)$$

This can be simplified to:

$$\delta_{it} = \eta_{it} \exp(\alpha) (RR_i - 1) \quad (7)$$

Model estimation was performed using WinBUGS software (Spiegelhalter et al., 2006). Each model was run using two chains with different starting points. Generally, between 3,000 and 5,000 MCMC iterations were discarded as burn-in. Then, 50,000 iterations for each chain were performed and final values sampled every 10th observation to avoid autocorrelation in the chains. This yielded a total sample of 10,000 observations of the posterior distribution for each parameter.

RESULTS

Table 2 presents the FB hierarchical models of weather-related crashes for the four different road types. The variables incorporated into the models were significantly different from zero; however, the coefficient for length (β_L) was not significantly different from one, which means that the expected number of crashes in the four models could be regarded as proportional to the length of the segments. The coefficient for traffic volume (β_V) was significantly smaller than one for all the models; therefore, the expected number of crashes increased at a decreasing rate with traffic volume. Figure 2 presents the SPFs for the models assuming proportionality between crash frequency and segment length. Interestingly, urban segments were at the extremes, presenting the highest and lowest expected number of crashes by mile of road for two-lane and

TABLE 2 FB Hierarchical Models of Weather-Related Crashes

Road Type	Variable	Mean	Std. Dev.	95% Credible Set	
				2.50%	97.50%
Urban two-lane	α	-4.959	0.426	-5.805	-4.128
	β_V	0.470	0.048	0.376	0.564
	β_L	0.952	0.116	0.730	1.179
	σ_v^2	0.434	0.078	0.295	0.603
	\bar{D}	3,614.0			
	DIC	3,784.0			
Urban multilane	α	-6.924	1.531	-9.870	-3.887
	β_V	0.653	0.166	0.322	0.973
	β_L	0.799	0.166	0.483	1.130
	σ_v^2	0.624	0.130	0.403	0.911
	\bar{D}	1,871.0			
	DIC	1,976.0			
Rural two-lane	α	-6.823	0.141	-7.096	-6.549
	β_V	0.704	0.018	0.671	0.738
	β_L	1.042	0.073	0.903	1.186
	σ_v^2	0.455	0.0340	0.393	0.528
	\bar{D}	24,990.0			
	DIC	26,170.0			
Rural multilane	α	-5.528	0.922	-7.350	-3.757
	β_V	0.542	0.095	0.357	0.728
	β_L	1.030	0.228	0.589	1.491
	σ_v^2	0.503	0.059	0.397	0.629
	\bar{D}	5,891.0			
	DIC	6,178.0			

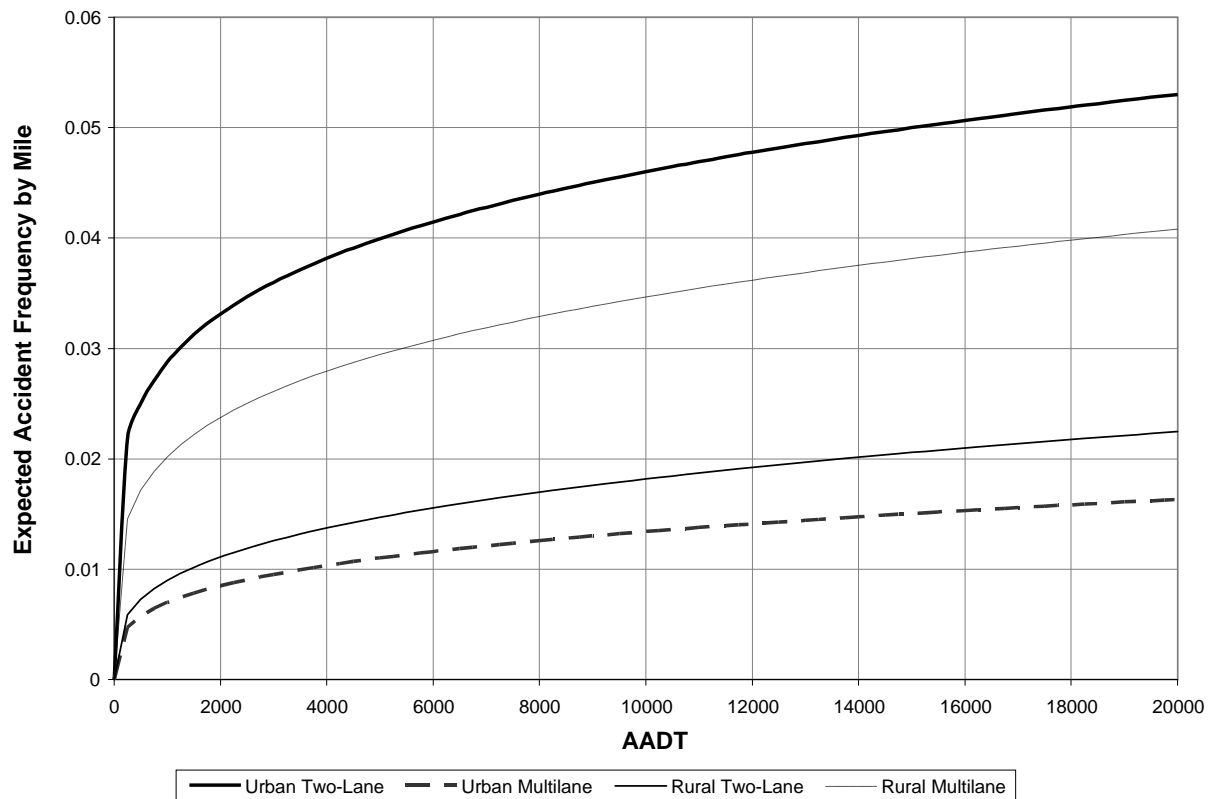

FIGURE 2 Safety performance functions by road type.

multilane roads respectively. By contrast, rural multilane segments presented a smaller expected number of crashes than rural two-lane segments. The mean risk for each road type [$\exp(\alpha)$] was the most important factor in the SPFs order. With a value of 7.02×10^{-3} the urban two-lane roads presented the highest mean risk corresponding to the top curve. On the other hand, urban multilane roads presented a mean risk of 0.9×10^{-3} , while the lowest curve and the rural two-lane and multilane roads had mean risks of 1.1×10^{-3} and 4.0×10^{-3} , respectively (middle curves). Although there is a multiplicative effect for the volume variable ($V_{it}^{\beta_V}$), its effect was not as marked as the mean risk effect in the order of the SPF curves.

Table 2 also presents the goodness-of-fit measures commonly used in FB statistics: the posterior mean of the deviance and the deviance information criterion (DIC) (Zhang et al., 2005). The deviance is estimated in the same way for frequentist and Bayesian statistics while the DIC is the Bayesian equivalent of the Akaike information criterion (AIC). As in the case of their frequent counterparts, deviance and DIC quantify the relative goodness of fit of the models; therefore, they are useful for comparing models. The variance of the random effects (σ_r^2) was significant for all of the models, which means that the models present overdispersion. Urban multilane shows the highest overdispersion with a variance of 0.624, while the lowest value is for urban two-lane roads with a variance of 0.434. Rural roads present a variance of the random effects of 0.455 and 0.503 for two-lane and multilane segments, respectively.

Knowledge about the full posterior distribution of parameters is very important, as shown in Figure 3. For example, the ninth segment on the rank presents an excess crash frequency of 0.459 with a standard deviation of 0.282. Assuming this variable as normally distributed, the 90% confidence interval is $(-0.003, 0.921)$; therefore, the value is not significantly different from zero at $\alpha = 0.05$. However, the 90% credible set (or confidence interval) from the full posterior distribution is $(0.097, 0.860)$, hence, significantly different from zero. The full posterior probability density of the parameter shown in Figure 3a sheds further light on the issue. The distributions of μ , δ , and RR present a heavy right-side tail increasing the standard deviation, but the area under the curve to the left of zero is very small for δ . The probability of the excess crash frequency being smaller than zero is easier to observe by comparing the δ -plot in Figure 3a with those in Figures 3b and 3c for segments ranked 1 and 23, respectively. The area under the curve to the left of zero for δ in Segment 487 (Figure 3b) is clearly small, while the area for Segment 4 (Figure 3c) is considerably larger. The same can be observed for the RR ; the area to the left of one for the segment ranked 1 is small, while the area for the segment ranked 23 is noticeably larger. The 90% credible sets for these variables are $(2.012, 5.386)$ and $(0.855, 3.331)$ for segments 487 and 4, respectively.

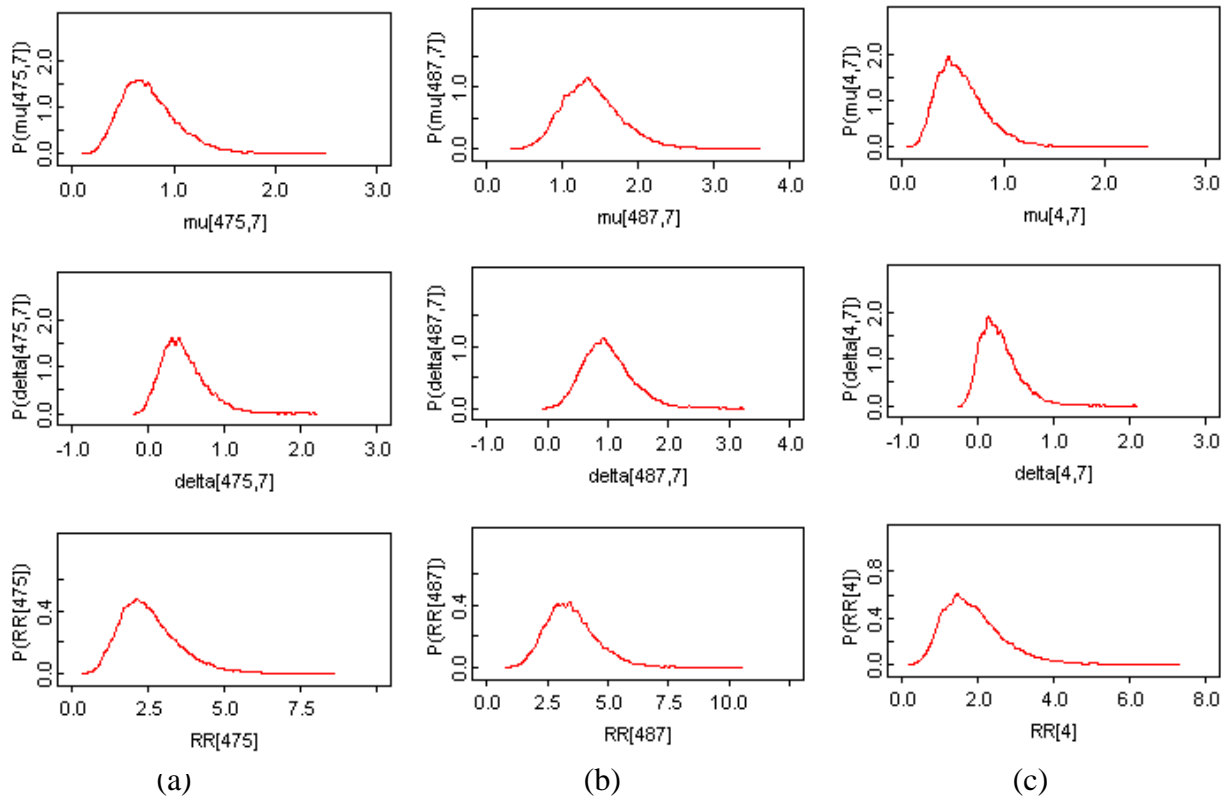

FIGURE 3 Posterior probability densities for several parameters in the urban two-lane model.

Finally, segments with significant excess crash frequency and *RR* were mapped to identify their locations as well as possible corridors or clusters of roads with higher risk of weather-related crashes; the map is not presented here for confidentiality reasons. Those segments are the candidates to be part of an information system to warn travelers of potentially significant weather events in their area. Maps of the elevated crash risk sites are included with this final report.

METEOROLOGICAL ANALYSES

The premise of the meteorological component of this project is that atmospheric conditions that instigated weather-related crashes in District 2 had a repeatable signature. Simply put, the composite of snow, rain, wind, ice, and fog accidents would reveal a similarity of atmospheric conditions with each different weather type. If this could be shown, based on existing data for crashes, then it was proposed that a scheme could be written that could uniquely and objectively identify those atmospheric conditions. This quantifiable measure of pressure, winds, temperature, and moisture would essentially constitute a fingerprint of those weather conditions associated with certain crashes. Provided there was a different signature for each, then it would be possible to compare that signature with numerical weather forecasts and ascertain how well the future (predicted) conditions might match past weather that was associated with some crashes.

The challenge of testing this premise had several components. First, a crash database in which weather conditions played a role needed to be excerpted from the overall database (this is the information provided by the civil engineering research team). Road segments were converted into latitude and longitude values. The weather-related crashes then were sorted by their atmospheric components. Rain, fog, and wind were relatively easy to sort. Snow and ice posed a more serious challenge. After review of the crash occurrences, these were divided into snow and ice storms and snow squall categories. The reason for this differentiation was due to the significant variation in atmospheric conditions associated with snowstorms compared with snow squalls. To accomplish the parsing of these events, all snow- and ice-related crash dates were reviewed using a daily weather map interface (http://docs.lib.noaa.gov/rescue/dwm/data_rescue_daily_weather_maps.html) to determine which type of event occurred. Having clarified these differences, the crash database could then be used to “train” the atmospheric measuring scheme.

The second challenge of testing the premise concerns the available meteorological data. Since an objective identification scheme was being developed, a suitable database was needed. The National Center for Environmental Prediction has compiled a “re-analysis” data set for the entire globe for every 6 h from January 1948 to the present. Surface and upper air observations formed the basis of the global re-analysis (GR). A sophisticated program was employed to estimate values of temperature, pressure, wind, and moisture at locations where few or no observations were available. The GR formed the foundation of the objective identification scheme. However, there were two issues. The data values are available at intervals (grid-points) that are spaced 190 km apart, meaning that only a few grid values are located in Pennsylvania and only one in District 2. The other issue is related to interpreting the data. In the science of the atmosphere, it is not the absolute value of a quantity that is necessarily significant, but rather its departure from a longer-term normal or average value. Therefore, a daily mean and its associated standard deviation of each atmospheric field, for each time and all available vertical levels, were computed (there are four daily time intervals, about a dozen layers, and at

least five atmospheric values on each layer). This baseline was used to determine the variation from normal of key atmospheric fields for each weather-crash event. For example, low-level moisture is important for fog crashes, whereas the juxtaposition of surface low and high pressure is significant for snowstorms and their related crashes. Even further, there are two elements to each of these fields, the magnitude of the deviation from normal and its configuration (shape) in the atmosphere relative to where the accidents occurred. From this, a new technique was developed that permits the objective identification of both the shape and magnitude of specific key atmospheric anomaly fields associated with each weather-related crash type. This technique has been peer-reviewed, and a paper describing it was published in the *Journal of Applied Meteorology and Climatology* in July 2007. In most types, there are between four and seven crucial atmospheric fields (such as wind direction at 5,000 ft for snow squalls). The weighting of each field's importance is included in this technique, and a summary value called "event type score" is then produced. A series of statistical validations was performed to ensure the accuracy of this procedure. Figure 4 is an example of the outcome of this identification technique.

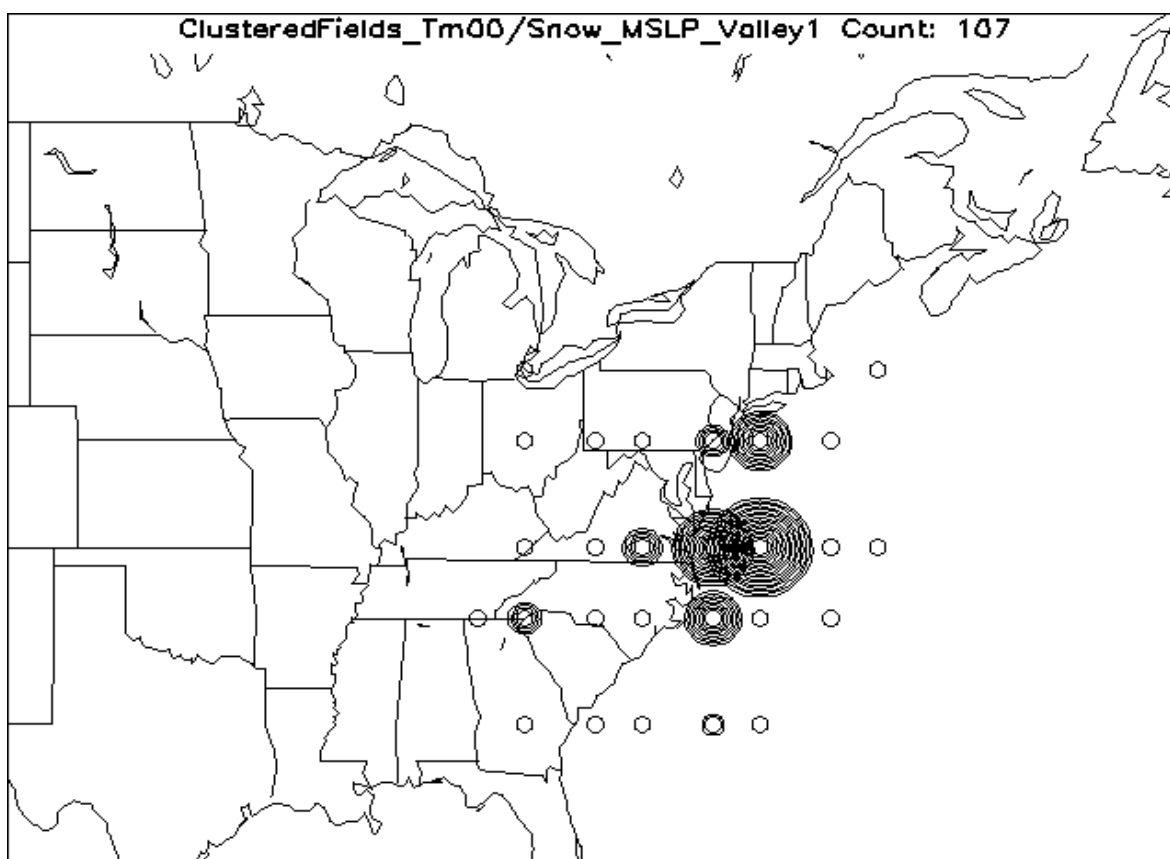

FIGURE 4 Example identification of shape and magnitude of key atmospheric anomaly fields. The size and number of concentric circles are related to the frequency of (in this example) surface low pressure in that location when there was significant snowfall in District 2.

For the 107 snowstorm cases identified, the concentric circles show the frequency of (in this case) the lowest surface pressure when crashes occurred in District 2. This new technique takes into account the shape of the cluster of locations as well as the magnitude (strength) of the low-pressure system compared with long-term averages. The research has yielded credible results, which are patterns that are unique to the weather hazard associated with crashes in District 2. The graphs in Figure 5 show the difference between random events and those trained using the fingerprinting technique. This demonstrates a proof of concept.

CONCLUSIONS

A FB hierarchical model has been developed to identify sites with promise for weather-related crashes in central Pennsylvania. The model is similar to others in the literature but allows the estimation of both the expected excess crash frequency and risk ratio. The FB formulation also allows for the inclusion of a random effects term to help address individual site differences.

The number of segments found to have a significant excess crash frequency of weather-related accidents is different for each road type and varies from 2% to 9%. This percentage depends on the significance level selected and for this work 95% confidence level was used. Since the excess crash frequency is a function of the relative risk, those segments with significant relative risk generally have a significant excess crash frequency as well.

Expected excess crash frequency presents the advantage of being an absolute measure. This excess is more closely related with the crash reduction achievable with engineering improvements than the relative risk; therefore it is more useful for the selection of sites for further engineering analysis, including cost–benefit studies.

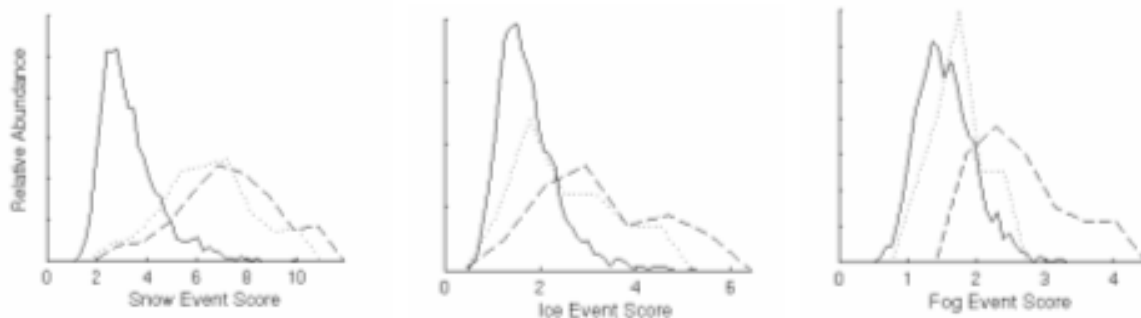

FIGURE 5 Distinction between random and trained events. The dark solid line shows the score when random dates are selected to identify the fingerprints of a snow, ice, or fog event. The dashed line shows the score in identifying the unique signature of these events selected from the crash dates. The higher scores indicate an identifiable signature has been found.

Knowledge of the precision of the estimates of excess crash frequency presents a clear advantage for decision making. Segments presenting high expected excess crash frequency with high statistical significance show potential for engineering improvements, while segments with high excess but lower statistical significance might be regarded as sites with less certainty in terms of their potential for safety improvement. Full posterior distribution sampling is also advantageous in this sense, since the precision is not established in terms of distributional assumptions, as in the case of normal distributed variables using the mean and the standard deviation, but drawn from the posterior distribution in the form of a credible set.

The use of random effects made possible the estimation of RR and excess crash frequency for each segment. Since random effects do not change over time they are likely to reflect site-specific differences, assuming that the segment characteristics remain relatively constant over time. Random effects also prevent regression to the mean bias by means of their prior distribution; while random effects capture unmeasured cofounders, they are part of a zero-mean normal distribution, which will pull the estimates to the mean.

If this were a project seeking to identify sites for action, the natural step would be an investigation of crashes at actual sites. Perhaps crash reports would be reviewed to assess the particular details of the crashes. This detailed review would help ensure that the correct road sections were identified.

The inclusion of spatial correlation in addition to unstructured random effects is another interesting extension of the research. Spatial correlation will further improve site level estimation by pulling strength from adjacent sites. Because the proposed HAR and CMS are intended for transmission and use in an area, spatial correlation is worthy of additional exploration.

Other possible covariates can be included in the models as part of the risk estimation. In fact, when exploring particular engineering improvements, such as lane widening, the inclusion of covariates related to the improvements may be desirable.

It is important to recognize that there are additional ranking methods that can be used. Ranking by posterior mean of the decision parameter (excess crash frequency) was used in this study, but ranking by the probability that the site is the worst and ranking by posterior distribution of ranks have also been suggested by other researchers. A possible extension of this work is the comparison of different ranking methods.

There are several additional steps needed to make this useful to operations. First, the Pennsylvania climate office has acquired a more refined data set for North America on which to base the training system. This new database is called the North American Regional Reanalysis (NARR), and its grid points are only 32 km (20 mi) apart or 6 times finer in resolution; its values are every 3 h, or twice the temporal resolution, and it contains 50 layers (four times the vertical resolution). In collaboration with the local National Weather Service office (CTP), the climate staff has downloaded (6.3 terabytes), parsed, compressed, and calculated the climatologic mean values of the NARR. The next step is to retrain the crash events using the NARR and recalibrate the event type scores for the higher-resolution data set. Once completed, the identification scheme would then be applied to the twice daily high-resolution computer forecasts for this region to objectively compare the forecast anomalies (compared with the NARR mean values) with the signature anomalies associated with past crashes. While this technique has been tested off-line, there is still some development required to link the real-time forecasts with the fingerprints of past crash weather occurrences. Threshold values will need to be established to reduce the false-positive alerts. Finally, the communication and interpretation of these alerts will need to be established with PennDOT.

REFERENCES

- Abbess, C., D. Jarret, and C. C. Wright. Accidents at Blackspots: Estimating the Effectiveness of Remedial Treatment, with Special Reference to the Regression-to-Mean Effect. *Traffic Engineering and Control*, Vol. 22, 1981, pp. 532–542.
- Advanced Road Safety and Weather Warning System (ARSAWWS). Work Order No. 3, Pennsylvania Transportation Institute, Mid-Atlantic University Transportation Center, August 2005–October 2006.
- Agüero-Valverde, J., and P. P. Jovanis. Spatial Analysis of Fatal and Injury Crashes in Pennsylvania. *Accident Analysis and Prevention*, Vol. 38, No. 3, 2005, pp. 618–625.
- Boon, C. B., and C. Cluett. *Road Weather Information Systems: Enabling Proactive Maintenance Practices in Washington State*. Report WA-RD 529.1. Washington State Department of Transportation, 2002.
- Congdon, P. *Applied Bayesian Modelling*. John Wiley & Sons, 2003.
- Eisenberg, D., and K. E. Warner. Effects of Snowfalls on Motor Vehicle Collisions, Injuries and Fatalities. *American Journal of Public Health*, Vol. 95, No. 1, January 2005, pp. 120–124.
- Fayish, A., and P. Jovanis. Comparison of Web-based Road-Weather Information from Three States. In *Transportation Research Record: Journal of the Transportation Research Board*, No. 1899, Transportation Research Board of the National Academies, Washington, D.C., 2004, pp. 44–54.
- Fayish, A. C., F. Gross, and P. P. Jovanis. User Perception of Web-Based Roadway Weather Information Systems: Navigability. Presented at 84th Annual Meeting of the Transportation Research Board, Washington, D.C., 2005.
- Gelman, A., J. Carlin, H. S. Stern, and D. B. Rubin. *Bayesian Data Analysis*. Chapman & Hall/CRC, Second Edition, 2003.
- Hauer, E. On Exposure and Accident Rate. *Traffic Engineering and Control*, Vol. 36, 1995, pp. 134–138.
- Hauer, E. Identification of Sites with Promise. In *Transportation Research Record 1542*, TRB, National Research Council, Washington, D.C., 1996, pp. 54–60.
- Hauer, E., J. Kononov, B. Allery, and M. S. Griffith. Screening the Road Network for Sites with Promise. In *Transportation Research Record: Journal of the Transportation Research Board*, No. 1784, Transportation Research Board of the National Academies, Washington, D.C., 2002, pp. 27–32.
- Hauer, E., D. W. Harwood, F. M. Council, and M. S. Griffith. Estimating Safety by the Empirical Bayes Method: A Tutorial. *Transportation Research Record: Journal of the Transportation Research Board*, No. 1784, Transportation Research Board of the National Academies, Washington, D.C., 2002, pp. 126–131.
- Hauer, E., B. K. Allery, J. Kononov, and M. S. Griffith. How Best to Rank Sites with Promise. *Transportation Research Record: Journal of the Transportation Research Board*, No. 1897, Transportation Research Board of the National Academies, Washington, D.C., 2004, pp. 48–54.
- Heydecker, B. G., and J. Wu. Identification of Sites for Road Accident Remedial Work by Bayesian Statistical Methods: An Example of Uncertain Inference. *Advances in Engineering Software*, Vol. 32, 2001, pp. 859–869.
- Lawson, A. B., W. J. Browne, and C. L. Vidal Rodeiro. *Disease Mapping with WinBUGS and MLwiN*. John Wiley and Sons, 2003.
- Lord, D., S. P. Washington, and J. N. Ivan. Poisson, Poisson-Gamma and Zero-Inflated Regression Models of Motor Vehicle Crashes: Balancing Statistical Fit and Theory. *Accident Analysis and Prevention*, Vol. 37, No. 1, 2005, pp. 35–46.
- Mahoney, W. The Prototype Winter Road Maintenance Decision Support System (MDSS): Project Status and Preliminary Results. *Proc., ITS America 13th Annual Meeting*, Minneapolis, Minn. (CD-ROM), May 2003.
- Marmor, M., and N. E. Marmor. Slippery Road Conditions and Fatal Motor Vehicle Crashes in the Northeastern United States, 1998–2002. *American Journal of Public Health*, Vol. 96, No. 5, May 2006, pp. 914–920.

- Miaou, S.-P., and D. Lord. Modeling Traffic Crash-Flow Relationships for Intersections: Dispersion Parameter, Functional Form, and Bayes versus Empirical Bayes Methods. In *Transportation Research Record: Journal of the Transportation Research Board*, No. 1840, Transportation Research Board of the National Academies, Washington, D.C., 2003, pp. 31–40.
- Miaou, S.-P., and J. J. Song. Bayesian Ranking of Sites for Engineering Safety Improvements: Decision Parameter, Treatability Concept, Statistical Criterion, and Spatial Dependence. *Accident Analysis and Prevention*, Vol. 37, No. 4, 2005, pp. 699–720.
- Miranda-Moreno, L. F., L. Fu, F. F. Saccomanno, and A. Labbe. Alternative Risk Models for Ranking Locations for Safety Improvement. *Transportation Research Record: Journal of the Transportation Research Board*, No. 1908, Transportation Research Board of the National Academies, Washington, D.C., 2005, pp. 1–8.
- National Academy of Sciences. Where the Weather Meets the Road: A Research Agenda for Improving Road Weather Services. www.nap.edu/catalog/10893.html, 2004.
- Pennsylvania Spatial Data Access. Pennsylvania State University. www.pasda.psu.edu/. Accessed May 25, 2005.
- Persaud, B., C. Lyon, and T. Nguyen. Empirical Bayes Procedure for Ranking Sites for Safety Investigation by Potential for Safety Improvement. In *Transportation Research Record: Journal of the Transportation Research Board*, No. 1665, TRB, National Research Council, Washington, D.C., 1999, pp. 7–12.
- Rao, J. N. K. *Small Area Estimation*. Wiley Interscience, New York, 2003.
- Root, B.V., P. G. Knight, et al. A Fingerprinting Technique for Identifying Significant Weather Events. *Journal of Applied Meteorology and Climatology*, Vol 7, 2007, pp. 1053–1066
- Spiegelhalter, D., N. Best, B. P. Carlin, and A. Linde. Bayesian Measures of Model Complexity and Fit. *Journal of the Royal Statistical Society B*. Vol. 64, Part 4, 2002, pp. 583–639.
- Spiegelhalter, D., A. Thomas, N. Best, and D. Lunn. *WinBUGS User Manual Version 2.10*. MRC Biostatistics Unit, Cambridge, U.K., 2006.
- Tunaru, R. Hierarchical Bayesian Models for Road Accident Data. *Traffic Engineering and Control*, Vol. 40, 1999, pp. 318–324
- Tanaru, R. Hierarchical Bayesian Models for Multiple Count Data. *Austrian Journal of Statistics*, Vol. 31, 2002, pp. 221–229.
- Zhang, C., J. N. Ivan, and E. Anagnostou. Relative Risk Analysis for Studying Impact of Adverse Weather Conditions and Congestion on Traffic Accidents. Presented at 84th Annual Meeting of the Transportation Research Board, January 2005.

USING WEATHER INFORMATION TO IMPROVE TRAFFIC SAFETY

Improving Traffic Safety Under Adverse Weather Conditions

CHARLA GASKINS

NATHAN HUYNH

EMMANUEL U. NZEWI

North Carolina A&T State University

Adverse weather conditions are uncontrollable, and it is known that inclement weather poses a risk to drivers. A more proactive strategy is needed to minimize automobile accidents during dangerous driving conditions. This study seeks to develop a model that will capture the relationship between driving conditions and automobile accidents. Through the use of the advanced traveler information system, such a model can be used to alert drivers of dangerous driving conditions and locations and to notify traffic authorities of places where safety measures need to be enacted. Data-mining models (e.g., neural network, regression trees) will be developed by using weather data from the National Climatic Data Center and traffic and accident data from the department of transportation.

Environmental Stewardship

ENVIRONMENTAL STEWARDSHIP

Winter Model

Roadside Salt Exposure Under Different Weather Conditions

GÖRAN BLOMQVIST

MATS GUSTAFSSON

Swedish National Road and Transport Research Institute (VTI)

The environmental model is a submodel in the Swedish winter maintenance management system, the Winter Model. The Winter Model will make it possible to assess the most important effects and their monetary value of changes in winter maintenance strategies and operations in Sweden. The effects are assessed for road users, road administrators, and the environment. Modeling the impact of the use of chemical anti- and deicing on roadside environment requires knowledge of the roadside exposure to salt, the vulnerability or dose-response relationship of the modeled environmental subjects and, preferably, the “cost” of the following impacts. In this paper, research results from some recent field studies are used to illustrate how the transport mechanisms responsible for the roadside exposure to deicing salt is working under different weather conditions. In order to improve the current model describing the roadside exposure to salt for even better prediction, the occurrence of plowing actions is also suggested to be incorporated into the model. Further it is suggested that, if also the presumably small depositions of dry salt aerosol particles on larger distance are to be described, the transport mechanism of dry salt crystals, breaking up into small airborne fragments and transported by the wind is also to be incorporated into the model describing the roadside exposure to deicing salt. The results in this paper are being incorporated into the Swedish Winter Model.

Sodium chloride has been widely used for decades in order to maintain road safety and accessibility of the road network at acceptable levels also during the winter season. The use of sodium chloride for deicing and anti-icing purposes started in the 1940s in the United States and has increased ever since, as the motoring has developed. In the Nordic countries the use of de-icing salt started in the mid-1960s. Already at an early stage, it was recognized that use of salt had not only the desired effects of improved traffic safety and accessibility but also several negative impacts. Numerous investigations of impacts on, e.g., vegetation, soil, and groundwater have been presented and the matter is still of great concern in North America, Europe, and Japan (1–9).

The government approval document of the Swedish Road Administration for the year 2007 points out an important long-term goal regarding groundwater quality, namely, that no later than 2010 are any major water supplies along the main road system to exceed Swedish standards for drinking water of good quality regarding any pollutant caused by roads or traffic (10). Such a target is not easily achieved and requires a focused action toward goal fulfillment. The main pollutant threatening the drinking water standards is the anti- and deicing salt used in the winter maintenance operations.

The aim of this paper is to describe how the roadsides are exposed to salt under different weather conditions. The cases shown are from the fieldwork of the development of a Swedish winter maintenance management system, called the Winter Model.

SALTING STRATEGIES

In today's winter maintenance in Sweden, the general recommendation is to "use as little salt as possible." It can be argued, however, that this recommendation is not based on an environmental concern as long as the two words "as possible" are connected only to requirements for a specific road surface friction value or snow depth tolerance limit. In fact, the regulations specify, so far, no environmental tolerance limits at all. On the other hand, what if the salting strategy would be formulated as "use as much salt as possible"? In this case, the words "as possible" should be based on the long-term tolerance limits of human health and nature, a basic concept in the government bill on which the current transportation policy actually is based (Government Bill 1997/98:56. Transport Policy for Sustainable Development). Of course, neither of these two standpoints can be used alone. In such delicate issues of conflicting goals as this is, it is rather a matter of balancing. What is of importance for the possibilities to make the right decisions is knowledge regarding how the system works.

ROADSIDE EXPOSURE TO SALT

Using salt for deicing has the purpose of preventing the occurrence of slippery conditions caused by frost, ice, snow, or slush. By forming a brine layer preventing snow and ice from bonding to the road surface, the presence of salt will also facilitate plowing of snow and slush off the road. The salt is also supposed to facilitate the formation of slush from the snow by the mechanical action of the vehicles and tires on the road surface, and the salt-laden slush is then intended to be forced off the road by the vehicles and gravity. Hence, the exposure of the roadside environment to salt is built into the system already from the beginning as the salt will leave the road as ploughed material, splash, spray, run-off, and dry crystals (Figure 1).

Blomqvist (11) suggested the airborne spreading of salt to be described by a function of the added transport mechanisms of splash and spray, each of which was described by an exponential function. The total deposition at a certain distance was then suggested to be described by the function:

$$\text{deposition} = a_{\text{splash}} \cdot e^{(b_{\text{splash}} \cdot \text{distance})} + a_{\text{spray}} \cdot e^{(b_{\text{spray}} \cdot \text{distance})} + \text{background}$$

The variables a_{splash} , b_{splash} , a_{spray} , and b_{spray} are supposed to be related to the above-mentioned five specific characteristics, also compiled in Table 1.

The model function has also been used successfully by Lundmark and Olofsson (3). By keeping the b_{splash} and b_{spray} variables fixed at -0.5 and -0.05 , respectively, they fitted the model to Deposition Data 2 to 100 m from a highly trafficked road, resulting in a maximal deposition rate for a_{splash} and a_{spray} of $8,000 \text{ mg m}^{-2} \text{ day}^{-1}$ and $120 \text{ mg m}^{-2} \text{ day}^{-1}$, respectively.

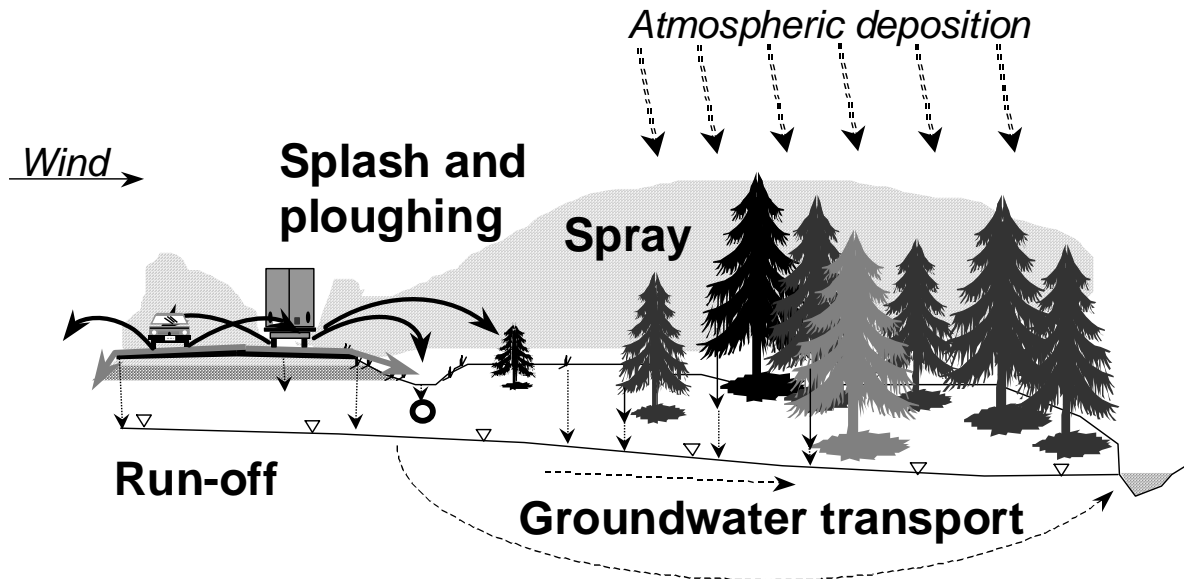

FIGURE 1 A conceptual model of transport mechanisms and pathways from the road.

ENVIRONMENTAL EFFECTS

There are, to begin with, three causal relationships that need to be known in order to understand the system of environmental effects of road salting: (1) what deicing or anti-icing action gives what exposure to the roadsides, (2) what exposure gives what dose (load) to the environment, e.g., vegetation or groundwater, and (3) what environmental dose (load) gives what damage. So far most studies on salt tolerance limits with regard to vegetation damage have been concerned with concentrations of sodium and chloride in plant tissue. From the road administrator's point of view, however, this indicator is not very useful. A more useful indicator would be the relation of deicing action (amount, method, technique, and timing) to the occurrence of damage, which would ultimately reveal what deicing strategy should be used on each individual occasion. This will however require knowledge of the three steps described above. At VTI (Swedish National Road and Transport Research Institute) a model called the Winter Model is being developed in order to make it possible to assess the most important effects, and their monetary value, of changes in winter maintenance strategies and operations in Sweden. The effects are assessed for road users, road administrators, and the environment.

MODELING THE ROADSIDE EXPOSURE

To understand the mechanisms responsible for the transport of the deicing salt away from the road, factors regulating the transport mechanisms should be studied separately. These factors can be divided into five main categories: traffic characteristics, road characteristics, maintenance and operation, meteorological factors, and the physical factors of the surroundings (Table 1). Few investigations have related the roadside salt exposure to the deicing action itself, to the road-surface and traffic characteristics during the action, or to the meteorological conditions.

TABLE 1 Factors Regulating the Transport Mechanisms and Influencing the Model Constants [Updated from Blomqvist (11)]

Main Categories	Factor	References
Traffic characteristics	Traffic intensity, volume	(6, 12, 20, 25)
	Traffic type	(6, 19)
	Traffic speed	(6, 12, 14, 20)
Road characteristics	Road surface	(15, 16)
	Road surface texture	(1, 4, 7)
	Road surface condition (wetness, etc.)	(12, 25)
Maintenance and operation	Salt use, amount	(1, 7, 8, 13, 25)
	Technique	(7)
Meteorological factors	Precipitation type	(17, 18)
	Precipitation amount	(8, 17, 18)
	Wind (e.g., direction and speed)	(8, 12, 21, 22, 25)
Physical factors	Topography	(21, 23, 24)
	Drainage system	(1)
	Land use (e.g., forest/open land)	(4, 22)
	Barriers (e.g., hedges, noise barriers)	(4, 7)

Knowledge of these relationships would aid the road administrator in managing the deicing action so as to minimize undesired environmental consequences.

METHODS

Salt Spray Sampling

The field site was equipped with “salt vanes,” a vane construction holding a five-layer cotton gauze filter perpendicularly aligned toward the wind direction (Figure 2, left) (26). The vanes were also equipped with a roof in order to protect the filter from precipitation. Although the salt vanes are not comparable to a natural surface such as a tree, they have many practical advantages (25). The filters are clean from salt, have each the same surface area and structure and the washing procedure to extract the collected salt is easy to standardize. Salt vanes are therefore very suitable for empirical modeling. The salt content on the filters is washed off the filter by de-ionized water by agitating it in a specially designed container (Figure 2, right) until the electric conductivity of the salt solution reaches a steady state. The washed-off salt solution is then investigated for its concentration of chloride.

Salt Splash Sampling

In order to collect the splash from the traffic and the plowed snow and slush masses from the plowing truck (Figure 3) plastic petri dishes (diameter = 142 mm) were attached to a rubber mat on the ground (Figure 4). The edges of the rubber mat were formed in a way that facilitated easy and fast exchange of the petri dishes. After 1-h exposure the lids were put on the petri dishes and new dishes were exposed. The petri dishes were then dried in room temperature and eventually

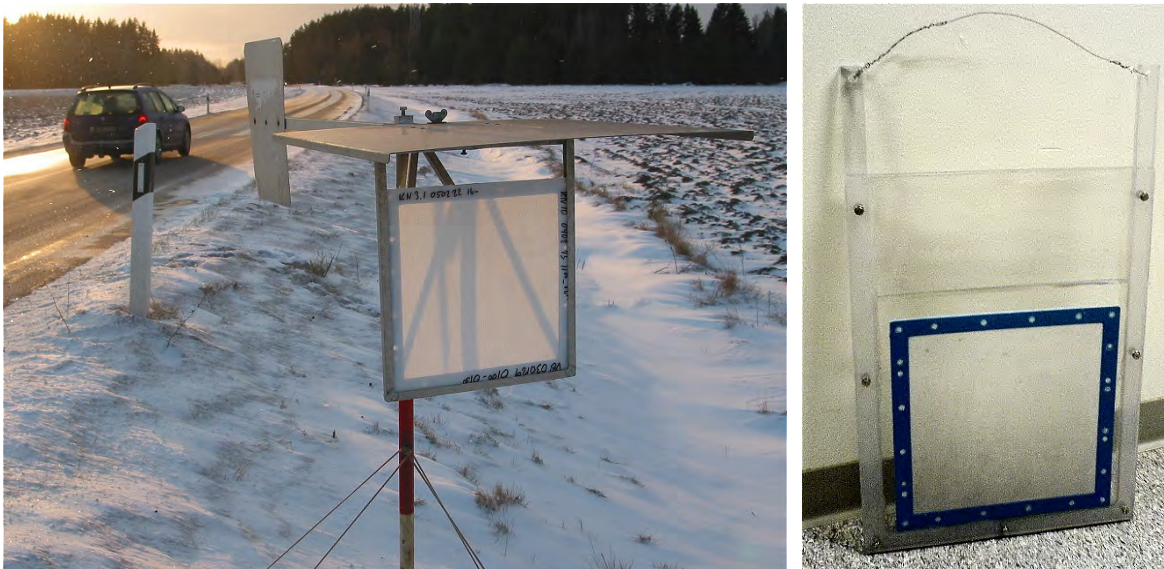

FIGURE 2 A salt vane for sampling airborne salt spray from the road.
To the right: dissolving the chloride in deionized water.



FIGURE 3 The plowing truck passing by at the field site. The traffic counting rubber tube is temporarily disconnected to facilitate the plowing truck's passage.



FIGURE 4 Salt deposition in plastic petri dishes on an hourly basis. The closest petri dish is at a distance of one meter from the road borderline. Please note the closeness of the cutting edge of the plow to the first petri dish.

the dishes were analyzed by dissolving the dried salt in 50 ml deionized water and then analyzed for their content of chloride.

Dry Aerosol Sampling

Measurements of PM_{10} , i.e., airborne particles with diameters less than $10\ \mu\text{m}$, also called inhalable particles due to their ability to be inhaled by humans, were made using an optical particle counter (TSI DustTrak) which was placed on a tripod approximately 2 m from the road edge. Sampling was made using an omnidirectional PM_{10} inlet at 1.6 m above ground.

RESULTS

Salt Spray Sampling

The salt spray sampling on the gauze filters allowed a sampling frequency of sampling times down to hourly exposure times. This was a great advantage since the weather conditions during those short periods were rather stable, and hence this allowed for a large range of weather conditions to be studied. Two different wind situations are described in [Figure 5](#) and [Figure 6](#).

In [Figure 5](#), a 3-h exposure during stable winds perpendicular to the road is seen. The result is very obvious: almost all spray is found in the filters on the leeward (downwind) side of the road, and only small amounts are found on the windward (upwind) side of the road. The occurrence of salt on the windward side may be a result of the transport of salt spray in the turbulent vehicle wake behind large vehicles as trucks and busses, but this has to be studied separately in even higher time resolution studies with for instance aerosol measurement instruments.

In Figure 6, on the other hand, a 2-h exposure during stable winds along the road is seen. The results show that under these conditions, the salt spray is transported quite similarly to both sides of the road, and the spray exposure extends further than 10 m from the road on both sides of the road.

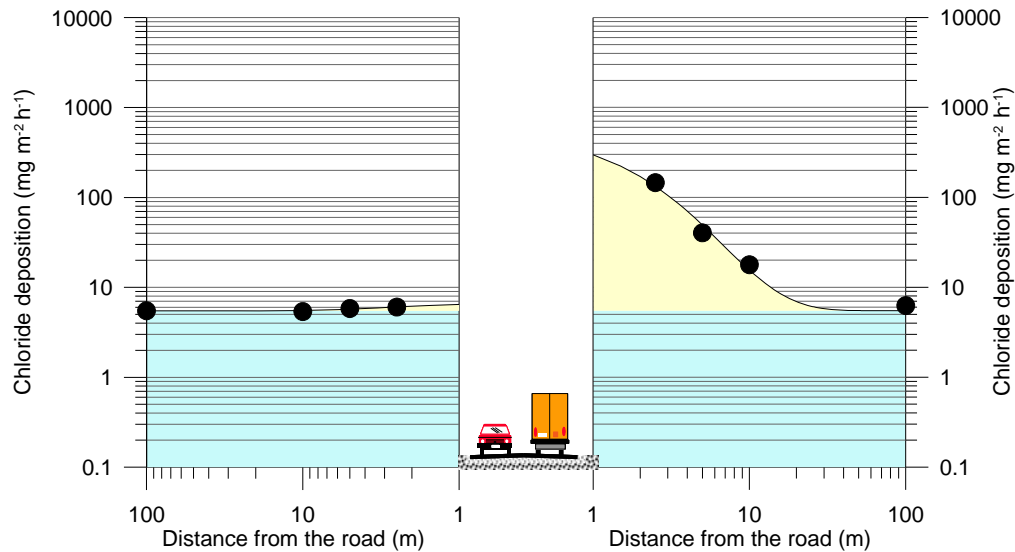

FIGURE 5 Salt exposure on salt vanes during 3 h with constant wind perpendicular to the road orientation.

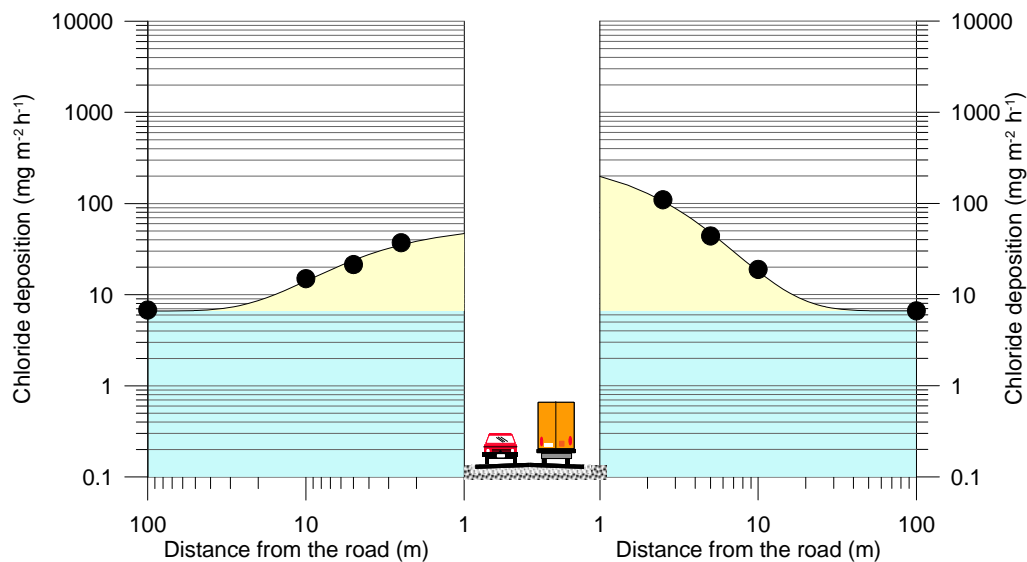

FIGURE 6 Salt exposure on salt vanes during 2 h with constant wind along the road orientation.

Salt Splash Sampling

The salt splash sampling in petri dishes mounted on a specially designed rubber mat nailed to the ground facilitated fast and easy replacement of the dishes. The rubber mat held the dishes hard enough for them not to be displaced by turbulence of passing vehicles.

What can be seen in this measurement (Figure 7) from February 13, 2004, is that the amount of splash is affected by the wind direction. The blue lines, four on the south side of the road and five on the northern side of the road, have higher values on the southern side of the road when compared to the same distance on the northern side. This is well in accordance with other studies (25). The five plowing occasions (three on the south side and two on the north side) show that the deposition pattern ends up very different during these hours as compared to hours when no plowing occurred. The deposition within 2 to 3 m from the road is increased more than 10 times on the leeward side of the road and approximately one hundred times on the windward side of the road. When comparing the plowing occasions, they are at approximately the same level at each hour and on each side of the road; however, the plowing exposure seem to be extending to a larger distance on the southern side of the road. If this latter phenomenon is an effect of the wind or not is not elucidated. But it seems likely that it rather is an effect of some other parameter, such as road surface characteristics. The road surface is leaning slightly towards the southern side, which may affect the wetness of the road surface and the effectiveness of the plowing.

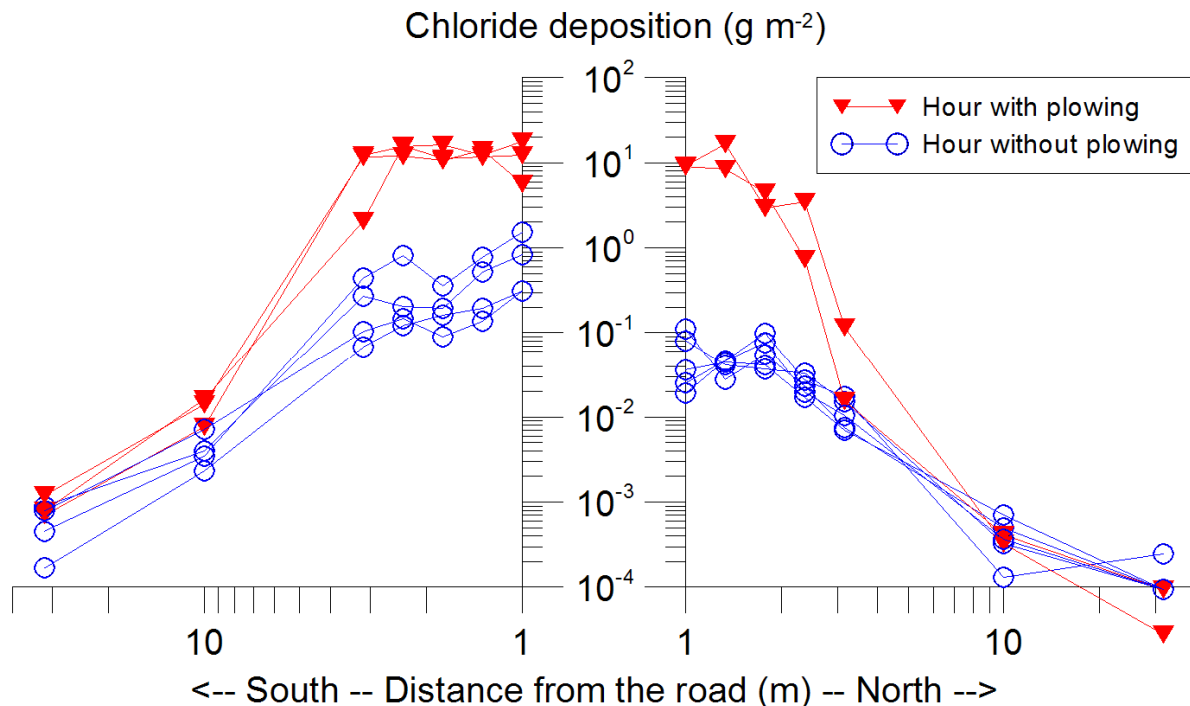

FIGURE 7 Chloride deposition at each side of a road on an hourly basis from 09:00 to 16:00. Hours where plowing actions have taken place are denoted with red triangles, and hours in which plowing actions have not taken place are denoted with blue circles.

Dry Aerosol Sampling

The dry aerosol sampling was made during a bright sunny day, just after a period with bad weather and lots of salting action. The road surface was dry and the bare eye could see the residual salt as white crusts on the asphalt surface and, as large vehicle passed by, the fragmented salt crust could be seen as dust clouds transported by the wind to the surroundings.

The sampling of PM_{10} shows a big difference between trucks with trailers and smaller vehicles. While the effects of private cars (light duty vehicles) are just discernable, the trucks with trailers stir up significant amounts of particles, which largely increase the PM_{10} concentration for about 20 s per vehicle.

It is not known what the size distribution in this investigation is more than that the particles are less than $10\ \mu\text{m}$ in diameter, but measurement of the particle size distribution with an Andersen air sampler in an investigation in Japan showed that the salt peaked at $3.2\text{--}5.4\ \mu\text{m}$ particle diameter (7). During the last years it has become evident that wear particles from road pavements, tires, brakes, and road maintenance strongly contribute to episodes with very high concentration of inhalable particles (PM_{10}) in outdoor air (28). These episodes normally occur during dry periods in winter and spring when accelerated wear and particle production occurs due to the use of studded tires and winter gritting. In Sweden trucks rarely use studded tires, which is the reason the high concentration of particles in this investigation cannot be explained by road surface wear, but most likely by the fragmentation and lifting of the salt crust on the pavement (Figure 8).

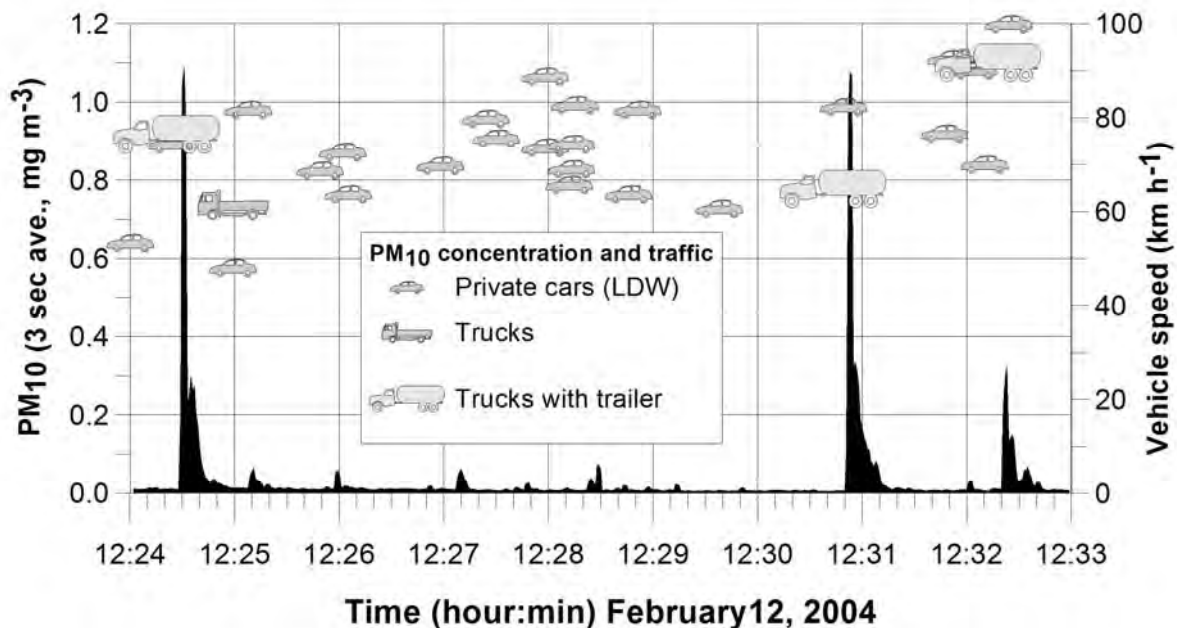

FIGURE 8 PM_{10} concentration and traffic type and speed at Road 1050 in Klockrike.

CONCLUSIONS AND DISCUSSION

Understanding how the mechanisms of salt transport from the road surface to the road surroundings works is a prerequisite if predicting of the roadside exposure to salt is to be successful.

A model using only splash and spray transport mechanisms has been shown to be successfully used in an environment with much higher traffic volume than where it was developed (3). However, in order to improve the model for even better prediction, the occurrence of plowing actions should also be incorporated into the model, since it is shown in this paper that the deposition pattern of plowed salt-laden snow and slush differs from the deposition pattern of splash and spray mechanisms. Further it is suggested that, if also the presumably small depositions of dry salt aerosol particles over larger distances are to be described, the transport mechanism of dry salt crystals, breaking up into small airborne fragments and transported by the wind, is also to be incorporated into a more complete model describing the roadside exposure to deicing salt.

The issue of road wear and studded tires is growing in Sweden (28). This fact makes it even more important to understand how the salt exposure mechanisms work since a lower usage of studded tires most probably will increase the usage of salt. At least this is the experience in Japan, where the quantity of applied deicing chemicals increased year by year with prohibitions on the use of studded tires (6, 8).

The results in this paper are being incorporated into the Swedish Winter Model, further described in another paper in these proceedings (29).

ACKNOWLEDGMENT

The Swedish Road Administration is acknowledged for financially supporting several of the projects on which this paper is based.

REFERENCES

1. Ostendorf, D. W., E. S. Hinlein, D. P. Ahlfield, and J. T. DeJong. Calibrated Models of Deicing Agent Solids, Pavement Texture, and Specific Conductivity of Highway Runoff. *Journal of Environmental Engineering*, Vol. 132, No. 12, 2006, pp. 1562–1571.
2. Ramakrishna, D. M., and T. Viraraghavan. Environmental Impact of Chemical Deicers—A Review. *Water, Air, and Soil Pollution*, Vol. 166, 2005, pp. 49–63.
3. Lundmark, A., and B. Olofsson. Chloride Deposition and Distribution in Soils Along a Deiced Highway—Assessment Using Different Methods of Measurement. *Water, Air and Soil Pollution*, Vol. 182, 2007, pp. 173–185.
4. Schipper, P. N. M., R. N. J. Comans, J. J. Dijkstra, and L. Vergouwen. Runoff and Windblown Vehicle Spray from Road Surfaces, Risks and Measures for Soil and Water. *Water Science and Technology*, Vol. 55, No. 3, 2007, pp. 87–96.
5. Kayama, M., A. M. Qureshi, S. Kitaoka, Y. Kitahashi, Y. Sakamoto, Y. Maruyama, M. Kitao, and T. Koike. Effects of Deicing Salt on the Vitality and Health of Two Spruce Species *Picea abies* Karst., and *Picea glenhi* Masters planted along roadsides in northern Japan. *Environmental Pollution*, Vol. 124, 2003, pp. 127–137.

6. Kadoyo, K., H. Ohnishi, Y. Namikawa, T. Nozaki, and S. Nakamae. *Research on De-icing Chemical Scatter Pattern/Run-off Quantity*. Presented at the 11th PIARC Winter Road Congress in Sapporo, Japan, 2002.
7. Suzuki, S., R. Kubo, and S. Yoshie. *Environmental Considerations Concerning Anti-icing/Deicing Agent Application*. Presented at the 11th PIARC Winter Road Congress in Sapporo, Japan, 2002.
8. Kimura, K., Y. Namikawa, S. Sone, and M. Kuwabara. *Research on Environmental Impact of De-icing Salts*. Presented at the 12th PIARC Winter Road Congress in Sapporo, Japan, 2006.
9. Murashige, Y., K. Onoduka, and N. Nemoto, *Study on the Impact of Anti-icing Chemicals on Plants*, Paper presented at the 12th PIARC Winter Road Congress in Sapporo, Japan, 2006.
10. *Fördjupningdokument Miljö, Vatten och material 2008–2017*. Vägverket, Publikation 2007:48, 2007 (in Swedish)
11. Blomqvist, G. *Air-borne Transport of Deicing Salt and Damage to Pine and Spruce Trees in a Roadside Environment*. Licentiate thesis. Division of Land and Water Resources, Department of Civil and Environmental Engineering, Royal Institute of Technology, Stockholm, 1999.
12. Eliasson, Å. *Spridning av vägsalt kring vägar*. M.Sc. thesis. Projektarbete 20p, Naturgeografiska Institutionen, Göteborgs Universitet, 1996 (in Swedish).
13. Czerniawska-Kusza, I., G. Kusza, and M. Dużyński. Effect of Deicing Salts on Urban Soils and Health Status of Roadside Trees in the Opole Region. *Inc. Environmental Toxicology*, Vol. 19, 2004, pp. 296–301.
14. McBean, E., and S. El-Nassri. Migration Pattern of De-icing Salts from Roads. *Journal of Environmental Management*, Vol. 25, 1987, pp. 231–238.
15. Öberg, G., and K. Gustafson, *MINSALT: A 5-Year Study to Minimize the Negative Effects of Salt*. VTI Rapport 372A:5. Swedish Road and Traffic Research Institute, Linköping, 1991.
16. Ericsson, B. *Projekt Restsalt, en sammanfattning av kunskapsläget*. Swedish National Road Administration, Report, 1995, (in Swedish).
17. Dragsted, J. *Vejsalt og Vejtræer, Resultater af et praktisk studie over vejsaltets vandring i jorden omkring vejtræer og invirkning på disse*, Statens Vejlaboratorium, Denmark, 1980 (in Danish).
18. Blomqvist, G., and E.-L. Johansson. Airborne Spreading and Deposition of Deicing Salt—A Case Study. *The Science of the Total Environment*, Vol. 235, 1999, pp. 161–168.
19. Hedalen, T., L. Alnæs, and T. Haavik. *Vegslitage—virkninger på helse og miljø*, In Miljøgeologisk konferanse i Norge 1995, Universitetet i Bergen, Norway, 1995 (in Norwegian).
20. Lumis, G. P., G. Hofstra, and R. Hall. Sensitivity of Roadside Trees and Shrubs to Aerial Drift of Deicing Salt. *HortScience*, Vol. 8, No. 6, 1973, pp. 475–477.
21. Sucoff, E. *Effect of Deicing Salts on Woody Vegetation Along Minnesota Roads*. College of Forestry, University of Minnesota, St. Paul, 1975.
22. Viskari, E.-L., R. Rekilä, S. Roy, O. Lehto, J. Ruuskanen, and L. Kärenlampi. Airborne Pollutants Along a Roadside: Assessment Using Snow Analyses and Moss Bags. *Environmental Pollution*, Vol. 97, No. 1–2, 1997, pp. 153–160.
23. Evers, F. H. Streusalzschäden an Waldbäumen, *Waldschutzmeckblatt*, 1981 (in German).
24. Persson, A. R., and J. Røyseland. *Skader på omliggande grønsakareal ved bruk av NaCl på vinterveg*, Report, Institutt for grønsaksdyrking, Norges Landbrukskole, Ås, Norway, 1981 (in Norwegian).
25. Gustafsson, M., and G. Blomqvist. Modeling the Exposure of Roadside Environment to Airborne Salt—A Case Study. In *Transportation Research Circular E-C062: Addressing Fiscal Constraint and Congestion Issues in State Transportation Planning*, Transportation Research Board of the National Academies, Washington, D.C., 2004, pp. 296–306.
26. Gustafsson, M. and L. Franzén, Dry deposition and concentration of marine aerosols in a coastal area. SW Sweden, *Atmospheric Environment*, Vol. 30, No 6, 1996, pp. 977–989.
27. Blomqvist, G., and M. Gustafsson. *The Environmental Sub-model of the Swedish Winter Model, From Real World Data to a Modeled Scenario*, Paper presented at the 12th PIARC Winter Road Congress, March 2006, Torino, Italy, In G. Öberg (ed.), PIARC 2006, VTI notat 19A-2006, Swedish National Road and Transport Research Institute, Linköping, 2006, pp. 43–51.

28. Gustafsson, M., G. Blomqvist, and P. Jonsson. Road Dust and Air Quality in Sweden. In *Transportation Research Circular E-C126: Surface Transportation Weather; Snow and Ice Control*, Transportation Research Board of the National Academies, Washington, D.C., 2008, pp. 179–188.
29. Möller, S. Winter Model: Road Condition Submodel. In *Transportation Research Circular E-C126: Surface Transportation Weather; Snow and Ice Control*, Transportation Research Board of the National Academies, Washington, D.C., 2008, pp. 512–518.

ENVIRONMENTAL STEWARDSHIP

Impacts of Magnesium Chloride-Based Deicers on Roadside Vegetation

NICOLE A. TRAHAN

Department of Ecology and Evolutionary Biology, University of Colorado

CURT M. PETERSON

West Virginia University

While many studies have documented the damaging effects of sodium chloride-based sand and salt deicers on roadside vegetation, currently much less is known about the impacts of newer magnesium chloride-based liquid deicers. This paper summarizes results from a 2004 field study assessing damage and physiology in the Colorado roadside conifers *Pinus ponderosa* and *Pinus contorta* exposed to deicing chemicals. In addition to salt exposure, the potential negative impacts of poor roadside soil quality, pollution, drought stress, nutrient availability, pests, disease, and mechanical damage were evaluated. Injury to the tree foliage in roadside environments correlated more strongly with levels of chlorides in older needle foliage ($R^2 = 0.696, p < 0.0001$) than any other factor examined. Decreased photosynthesis rates occurred in roadside trees during the spring compared to trees more distant from the roadside in the same location. In a greenhouse study, equivalent amounts of a magnesium chloride-based deicer, especially when applied directly to conifer sapling foliage, were far more damaging than exposure to a sodium chloride-based sand and salt mixture. Deicer exposure led to needle tissue injury, depression in photosynthesis rates, and sapling mortality at higher concentrations. Although advantageous economic and safety reasons remain for agencies to continue apply magnesium chloride-based deicers, sound environmental stewardship must include accounting for the subsequent costs to roadside vegetation.

Although the use of deicing chemicals remains important for road navigation and traffic safety, it has been well established that road deicers have potential deleterious impacts on living organisms. It is also evident that roadside vegetation in particular may be acutely affected (1–3). While many studies have looked at the effects of solid sodium chloride-based deicers, less is known about the effects of magnesium chloride (MgCl_2)-based liquid deicers on roadside vegetation. This knowledge deficit has led to continuing claims by state agencies that MgCl_2 -based deicers have no negative environmental impacts or that they provide a more environmentally friendly alternative to sodium chloride-based sand and salt deicers (4). In Colorado, public concern over the appearance of dead and dying trees along mountain roadways increased after the initiation of MgCl_2 -based deicers. Although commiserate with the introduction of liquid deicer use, the cause of vegetation damage was unconfirmed and often attributed to vehicular pollution or insect damage (5).

Roadside environments may impose many potential biotic and abiotic pressures on a plant community. Vegetation along roadways may be exposed to increased loads of damaging pollutants such as heavy metals, nitrous oxides, and sulfur dioxide (6, 7). The roadside soil structure may be degraded, lowering water infiltration and nutrient availability, thereby increasing vegetation stress loads (8–10). The combined stress caused by these factors in turn

may act synergistically to render vegetation more vulnerable to infection by fungal or insect pathogens. To date, little published research documents the impacts of certain deicers on vegetation in relationship to other potential roadside stresses.

This paper summarizes results from a 2004 study (11) assessing damage in Colorado roadside vegetation exposed to deicing chemicals. The presence and impact of other plant stresses that occur in the roadside environment were also evaluated. Along Colorado highways, salt exposure, physiology, and health were examined in two native conifer species, ponderosa pine (*Pinus ponderosa*) and lodgepole pine (*Pinus contorta*), prior to and during a deicing season. At the field study sites, these conifers also were assessed for the presence and potential impact of roadside soil quality, water stress, pollution, mechanical damage, and pests or disease. Finally, this study compared the effects of a $MgCl_2$ -based liquid deicer and a solid sand and salt mixture in use in Colorado on conifer sapling health and physiology in a controlled greenhouse experiment.

Background

In the state of Colorado, chloride-based road deicers are used to melt snow and ice and suppress dust during dry periods. During a snow event, the Colorado Department of Transportation (CDOT) applies liquid magnesium chloride ($MgCl_2$) deicer solutions at 80 gal/lane mile (188 L/km) and solid sodium chloride (NaCl) and sand mixtures at 500 lbs/lane mile (141 kg/km). For preventative deicing or anti-icing, $MgCl_2$ is applied at 40 gal/lane mile (94 L/km) (Phillip Anderle, CDOT, unpublished data). Commercial deicers may also contain inert binders and/or anticorrosives, which are proprietary and depend on the manufacturer. Due to efficacy, cost, and the reduction in particulate pollution, CDOT began using liquid deicers in the late 1990s with applications to the state's roadways approaching 9 million gallons (34,000 kL) in the winter of 2006–2007 (4).

Impacts of Deicing Salts on Roadside Vegetation

Deleterious deicing salt impacts on roadside vegetation have been well established by numerous studies (1–3). Chloride is considered the most toxic element of deicing salt, and foliar concentrations of chloride have been established to be directly correlated with levels of tissue necrosis in roadside trees (2, 12, 13). Additionally, symptom severity is also associated with foliage sodium content (3, 14). Pines are particularly noted for their sensitivity to roadside deicing salts (3, 14). Symptoms of salt damage in pines are expressed primarily in older needle growth and include chlorosis and necrosis of needle tissue beginning from the needle apex, with premature needle abscission, twig dieback, growth suppression, and mortality occurring in more severe cases (3, 15–18).

Salinity can limit the vegetative and reproductive growth of plants by inducing physiological dysfunctions and causing widespread harmful effects (17). Directly, excesses of both Na^+ and Cl^- create specific ion toxicities leading to growth depression, leaf tissue necrosis, shoot dieback, and in severe cases, mortality (1). Injury may be caused by salt-induced changes in metabolic processes such as photosynthesis, respiration, and protein and nucleic acid synthesis and through the alteration or suppression of enzyme activity and hormone balance (16, 17). It has been clearly established that deicer salinity reduces the rate of photosynthesis in pine species,

and ultimately this reduction in carbon assimilation and subsequent growth may be a more important indicator for determining overall impact and injury than visible damage (19).

Effects of Deicing Salts on the Soil Matrix

Deicing salts in soils may affect roadside vegetation either directly through root uptake, or indirectly through deicer driven changes to the soil matrix. Deicing salts are plowed along with snow onto the shoulder of the road. As the snow melts, dissolved salts move overland until they percolate into the soil matrix or enter surface water systems. Deicing salts may also be splashed through the action of vehicular traffic on soils adjacent to the roadways or deposited further away through the drift of aerially suspended particulates (8). Soil infiltration is dependent upon slope, drainage, exposure (amount and distance from road), frost, and soil permeability (6, 8).

As deicing salts accumulate in roadside soils, they impact roadside vegetation through effects on soil structure, nutrient status, and a reduction in osmotic potential leading to vegetation water stress and drought-like symptoms. Effects on soil structure are ion dependent; for example, chloride is the principal anion contributing to soil salinity. The effects of chlorides on the soil include swelling, deterioration of structure, decreased permeability to water, and increased erosion potential (9). Chloride ions are highly soluble, and as they do not readily volatilize, precipitate, or form complexes, they are freely transported and leached out of the soil matrix relatively rapidly (1, 9, 10). Chloride ions may complex with heavy metals, however, increasing their water solubility and potential translocation into plant tissues (9).

An abundance of sodium ions also leads to harmful effects on soil structure. As sodium ions leach through the ground and adsorb onto negatively charged soil clay particles, they may replace other cations, usually the plant nutrients calcium and magnesium (8, 10). When a soil is saturated with sodium and depleted of calcium and magnesium, the soil becomes alkali and the pH may increase to as high as 10. Deicing salt treatments containing sodium have been documented to increase the pH of the soil matrix and decrease the electrical conductivity of the soil due to Na^+ saturation (3). Additionally, Na^+ in roadside soils can disperse soil colloids, promoting accumulated heavy metal mobilization to ground water (10).

In contrast to Na and Cl ions, magnesium appears not to be toxic even at high concentrations and can improve soil structure, reducing erosion and sediment loads in aquatic systems (20). Magnesium ions are also highly soluble and readily transportable (9). The primary detriment of excess magnesium in roadside soils seems to be the potential to contribute to heavy metal mobility (21). Magnesium ions (Mg^{2+}) are better able to compete for cation exchange sites for trace metals; thus Mg^{2+} may displace and mobilize heavy metals to a greater extent than Na^+ .

Aerial Drift and Foliar Penetration of Deicing Salts

Deicing salts may infiltrate the roadside environment and impact vegetation not only through surface runoff and soil penetration but also through the airborne drift of salt particles (14, 19). These particulates are primarily a product of vehicle traffic resuspension, plowing, and wind (22). Significant amounts of deicer are potentially transported in this manner. For example, Blomqvist and Johansson (23) demonstrated that between 20% and 63% of the NaCl-based deicing salts applied to highways in Sweden were carried through the air and deposited on the ground 2 to 40 m (6.6 to 131.2 ft) from the roadside. Conifers may be especially vulnerable to aerial drift of salts due to the high surface to volume ratio of their foliage. Salt deposition on

roadside conifers causes both specific ion toxicities in tissues and osmotic stress resulting in water loss and cell plasmolysis. This ultimately causes necrosis and premature needle abscission (2, 3, 19). Many studies have indicated that needle necrosis, twig dieback, and bud kill are associated with areas of heavy deicing salt usage, with trees and foliage down wind and facing the roadside more heavily affected than trees further away (13).

Environmental Impacts Specific to Magnesium Chloride

Unlike information on NaCl-based deicers, information and studies on the environmental impacts of MgCl₂-based deicers have been limited. Experiments with the MgCl₂-based deicer Ice Ban showed reduced turf grass germination and vegetation stress at higher deicer exposure levels (24). Soil-applied MgCl₂ was found to cause foliar injury in one-year-old ponderosa pine ramets, but to a lesser degree than NaCl (25). In 1993, 293 lodgepole pine and spruce trees within six feet of county road 491 in Rocky Mountain National Park were found to be dead or dying. The roads had been treated with MgCl₂ as a dust palatine, and elevated levels of magnesium and chloride were found to be present in affected pine tissues (26). The damage was attributed to the salt although it was unclear if the uptake had been through root or foliar pathways. Currently, Rocky Mountain National Park no longer uses MgCl₂ for dust stabilization.

In a report to the Colorado Department of Transportation on MgCl₂ impacts to aquatic ecosystems, Lewis (20) concluded that deicer use in Colorado is unlikely to cause or contribute to environmental damage at greater than 18.3 m (60 ft) from the roadway. Although no evidence exists that current deicing practices lead to runoff with concentrations known to be harmful to aquatic life, Lewis concluded that the chloride components may damage roadside vegetation. Lastly, it is important to note that liquid deicers such as MgCl₂ improve air quality by reducing particulates in the atmosphere and decrease potentially harmful sediment loading in aquatic systems (4, 20).

METHODS

For a detailed methodology, please see Trahan and Peterson (11).

Field Study Sites

Eight study sites along Colorado, highways exposed to sand and salt (NaCl) and MgCl₂-based liquid deicers were selected in cooperation with CDOT. These sites represented areas where roadside conifer health and survivorship was of concern. Four study sites surveyed lodgepole pine (*Pinus contorta*) along the I-70 corridor, and four sites surveyed ponderosa pine (*Pinus ponderosa*) in natural and planted sites along Highway 36 and in metro Denver. Sites were also chosen where adjacent and accessible trees of equivalent trunk diameter and stand structure distant from the roadside existed in order to make health and physiological comparisons. The distance of selected trees away from the roadside varied by site from approximately 45 to 95 m (148 to 312 ft).

Assessment of Conifer Health and Sampling

At each field site, average percent necrotic foliage in the tree's crown and the years of needle growth retained were visually estimated in order to provide an overall appraisal of tree health. Needle tissue, twig tissue, and soil samples were collected at each field study site from mid-September and early October 2004, prior to the beginning of deicing applications. Representative tissue samples were obtained from five pine trees adjacent to the roadside and five pine trees located distant from the roadside at each individual site for a total of 80 trees. Three soil cores up to 12 in. (30.5 cm) deep were taken at random locations one meter from the trunk of each tree and homogenized for analysis.

Chemical Analyses

All chemical analyses were carried out by Weld Laboratories, Inc., Greeley, Colorado. Soil pH, total soluble salt levels, sodium, and magnesium contents were quantified, along with soil organic matter, total organic carbon content, total nitrogen (Kjeldahl), phosphorous, calcium, and potassium. Soil heavy metal levels were assessed for silver, cadmium, chromium, copper, nickel, lead, and zinc. Tree tissues were also evaluated for percent dry weight magnesium, sodium, and chloride content along with total organic carbon, nitrogen, potassium, phosphorus and calcium levels, as well as for the metals silver, cadmium, chromium, copper, nickel, lead, and zinc. Needles representative of average foliage health were examined using scanning electron microscopy for presence of surface coating and stomatal occlusion. Elemental composition of needle coating was investigated using scanning electron microscopy (SEM) with an attached energy dispersive spectrometry (EDS) system.

Assessment of Conifer Physiology

Leaf gas exchange was measured on attached, fully developed needle tissue free of necrosis and chlorosis at each site using an infrared open gas exchange system (LI-6400 portable photosynthesis system, Li-Cor, Lincoln, Nebraska). Conditions during gas exchange were standardized at a saturating irradiance of $1,600 \mu\text{mol m}^{-2} \text{s}^{-1}$, and 400 ppm CO_2 . Measurements were repeated twice in a series on each tree at each site, and were completed between 1,000 h and 1,400 h on the same day to minimize temperature and humidity differentials. Leaf water potential (ψ_w) was evaluated on freshly excised branches predawn using a Scholander-type pressure chamber (Soilmoisture Equipment Corporation, Goleta, California).

Assessment of Disease, Insect, Animal, and Abiotic Damages

Independent evaluation of the study sites occurred in October of 2004 for common Colorado conifer diseases including dwarf mistletoes, fungal needle casts, *Elytroderma* needle disease, western gall rust, stem and branch internal decay, and root diseases such as *Armillaria*. Trees also were examined for animal related damage such as gnawing by rodents or deer and elk. Insect assessments included evaluation of any injury related to needle miners, bark beetles such as *Ips* and the mountain pine beetle, wood boring insects, bark aphids, twig beetles, and pine needle scale. Finally, trees were appraised for damage from abiotic sources such as frost, snow breakage, and drought.

Greenhouse Study

One hundred forty-four 2-year-old saplings of *P. contorta* and 144 2-year-old saplings of *P. ponderosa* were selected for approximate equivalent size, caliper diameter, and health and then randomly divided into 12 treatment blocks of 12 trees. Saplings were planted in a 1:1 mixture of peat moss and vermiculite in rectangular tree pots with a surface area of 116.6 cm (4 in.) and depth of 35.6 cm (14 in.). Saplings were fertilized once per month with all-purpose Miracle-Gro in an equivalent concentration to 60 ppm nitrogen. To remove any confounding drought stress, saplings were watered to one half of field capacity twice weekly. Temperature extremes were also prevented through greenhouse automated heating and cooling systems.

Saplings were exposed to a concentration gradient of either liquid $MgCl_2$ deicer (FreezGard) atomized to a fine mist and applied directly to the foliage, $MgCl_2$ deicer applied directly to the sapling container soil matrix, or sand and salt deicer applied directly to container soil. FreezGard consists of a base of 29% to 31% $MgCl_2$ hexahydrate in water, while the sand salt mixture used by CDOT consists of 15% NaCl in a matrix of granitic gravel and sand particles. A concentration gradient of deicers was applied with the upper bound being full roadbed application strength (100%), and subsequently reduced to 50%, 10%, and 0% of roadbed application strength. Desired dilution levels were obtained by a reduction in application mass of sand and salt and through the addition of distilled water for $MgCl_2$. Saplings were treated with 9.6 g of sand and salt deicer and 12.2 ml of $MgCl_2$ deicer at the appropriate concentration level every 10 days for 3 months. Treatments were set to mimic deicing season conditions throughout the peak of the winter based on CDOT snow shift data for this study's field site locations.

Leaf-level gas exchange was measured on attached, fully developed and photosynthetically active needle tissue free of necrosis and chlorosis under standardized conditions as explained above. Necrosis patterns and severity also were assessed pre- and post-deicer treatments.

Statistical Analysis

Significant differences in exposure variables, locations, and treatment type responses were determined by factorial ANOVA and Bonferroni post hoc comparisons. Pearson correlation coefficients were calculated to find relationships between environmental variables and tree health and physiology. Differences were considered significant at $p < 0.05$. Statistical analysis of all data was carried out using SAS version 8.1, SAS Institute Inc., Cary, North Carolina.

RESULTS AND DISCUSSION

Evidence of Roadside Vegetation Exposure to Deicers and the Impact on Tree Health

Colorado lodgepole (*P. contorta*) and ponderosa (*P. ponderosa*) trees adjacent to the roadside exhibited significantly greater levels of crown needle tissue death ($\bar{x} = 21\%$) and foliage loss than trees away from the roadside ($\bar{x} = 2.6\%$; [Figure 1a](#)). This pattern of damage reflected exposure to salt contamination through deicing practices and site topography. Foliar injury was concentrated along roadways or where surface runoff collected and was generally noted to be more severe on the side of the tree facing the roadway ([Figure 1b](#)). The characteristics of

vegetation injury conformed to previously reported deicing salt damage patterns, including exposure to magnesium chloride (2, 3, 9, 14, 17, 18, 26). Damage was concentrated in older needles, and characteristically occurred as necrosis and chlorosis in the needle tips, with tissue

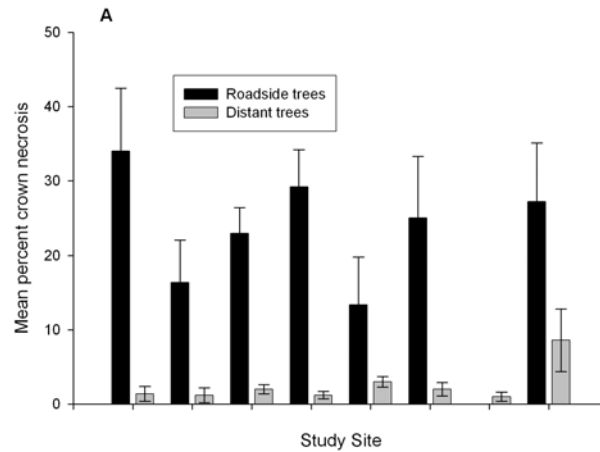

(a)



(b)



(c)

FIGURE 1 Evidence of necrosis in tree foliage along Colorado highways, 2004: (a) mean percent necrosis in the crown foliage of trees next to the roadside and distant from the roadside across study sites as visually estimated, $n = 5$; (b) lodgepole pine (*P. contorta*) adjacent to I-70 and distant from I-70 (note foliage damage and loss of needles in the roadside trees); and (c) tissue necrosis occurring from needle tips and concentrated in older foliage in lodgepole (*P. contorta*) and ponderosa (*P. ponderosa*) pines near roadsides.

death advancing to the needle base. Injured older foliage tended towards premature abscission, resulting in less needle retention and thinner overall crown vegetation (Figure 1b, c)

Significantly elevated levels of salt ions were noted in roadside soils (Table 1). Soil pH, total soluble soil salts, and soil sodium levels were higher in roadside soils compared with soils at a distance from the roadside, and soil Na levels known to damage vegetation were observed (9, 19). Overall, foliar injury did not significantly correlate with total dissolved soil salts, and only weakly correlated with soil pH ($R^2 = 0.17$, $p < 0.001$) or with soil Na content ($R^2 = 0.20$, $p < 0.0001$). This indicates that greater damage may be due to accumulated specific ion toxicities in plant tissues rather than soil osmotic stress. Although present in quantities thought to be detrimental to conifers (9, 19), soil chloride levels did not correlate significantly with foliage death in study site trees. This finding is similar to other studies of deicer use and soil chloride levels (18), and is likely due to the mobility of the Cl^- ion in the soil matrix as a result of spring and summer precipitation. Soil magnesium content was significantly lower in deicer exposed roadside soils in contrast to other studies (27), and may reflect Na displacement (8, 10). Additionally, soil Mg levels failed to correlate significantly with tree necrosis, suggesting no adverse impacts on conifer health.

Needle sodium, magnesium, and chloride contents were significantly elevated in tree foliage along the roadside (Table 1). Foliage damage in roadside conifers correlated significantly with the presence of salt ions in plant tissues. As the sodium ($R^2 = 0.611$, $p < 0.0001$) and chloride ($R^2 = 0.696$, $p < 0.0001$) content in needle tissues increased, so did observed levels of foliar injury in Colorado roadside pines (Figure 2). These findings are consistent with other studies of salt exposure in roadside vegetation (18). Also, sodium and chloride in the tissues of Colorado roadside pines exceeded levels known to damage foliage (1, 19, 25). These levels persisted even in late fall, prior to the next deicing season, indicating that salts remain in the needle tissue causing year-round and long-term stress to the exposed trees. Magnesium in soils and plant tissues displayed a notably different relationship to vegetation damage than Na and Cl. Overall, the increased Mg in plant tissues and soils did not significantly correlate with increased damage to roadside trees. This evidence supports the conclusions of other researchers that Mg is unlikely to be biologically toxic even at high concentrations (20).

TABLE 1 Mean Soil pH, Total Soluble Salts, and Na, Cl, and Mg Levels in Tree Tissues and Soils Adjacent to the Roadside and Distant from the Roadside, $n = 8$

	Roadside	Distant from Roadside
Total soil soluble salts (mmhos/cm)	0.523	0.462
Soil pH ($-\log [\text{H}^+]$)	6.27 ^a	5.71
Soil Na (ppm)	184.8 ^a	114.6
Soil Cl (ppm)	1,426.3	1,555.3
Soil Mg (ppm)	387.0 ^a	473.9
Needle Na (% dry weight)	0.153 ^a	0.057
Needle Cl (% dry weight)	1.411 ^a	0.314
Needle Mg (% dry weight)	0.512 ^a	0.464

^a Denotes significant differences at $p < 0.01$.

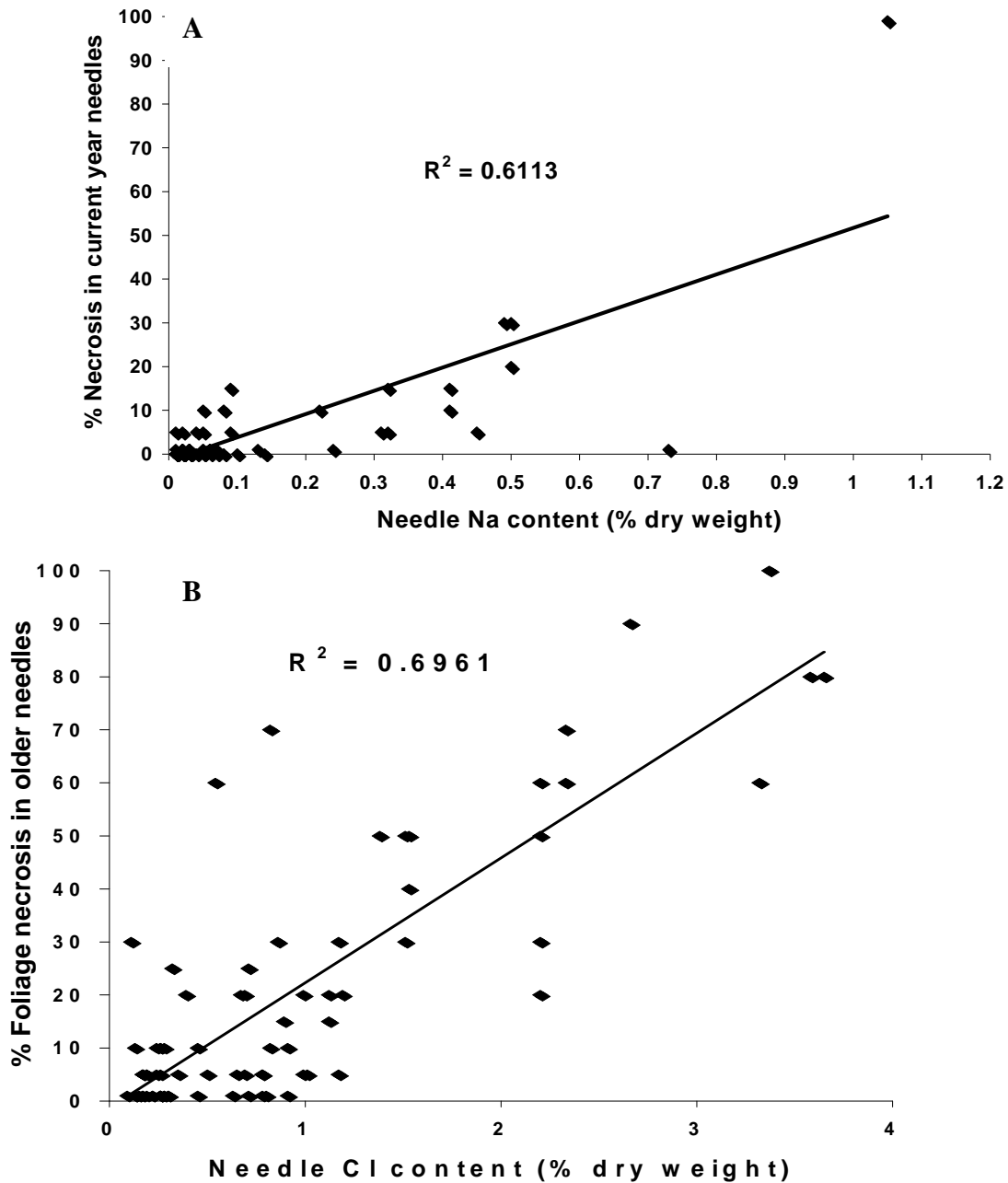

FIGURE 2 Correlation between observed tree foliage damage and salt ion content of tree tissue: (a) percent dry weight sodium content of current year needles and observed needle damage, $R^2 = 0.696$, $p < 0.0001$, and (b) percent dry weight chloride content of all previous years of needle growth and observed needle damage, $R^2 = 0.611$, $p < 0.0001$, $n = 80$.

Direct atmospheric deposition of deicer particulates also occurs on roadside conifers in Colorado. Most of the study trees both near and removed from the roadside environment displayed substantial needle surface deposits (Figure 3). In this study, surface deposits contained a number of different elements including Mg, Na, and Cl salts as well as granite derived silt-like deposits probably consisting of quartz (SiO_2) and feldspar (aluminum and potassium silicates) found in igneous rock (data not shown). Patterns of elements found and coating morphology matched those seen on needles artificially treated in the laboratory with NaCl sand and salt deicer and liquid magnesium chloride deicer (Figure 3*b, c*). Therefore, it is considerably likely that the salts and fine rock particulates on the roadside conifer needles are a product of roadside deicing practices. As such, aerial drift of deicing particles may have contributed to salt accumulation in needle tissues that exceeded reported background levels for pines trees even over 100 m (328 ft) from the roadway (data not shown).

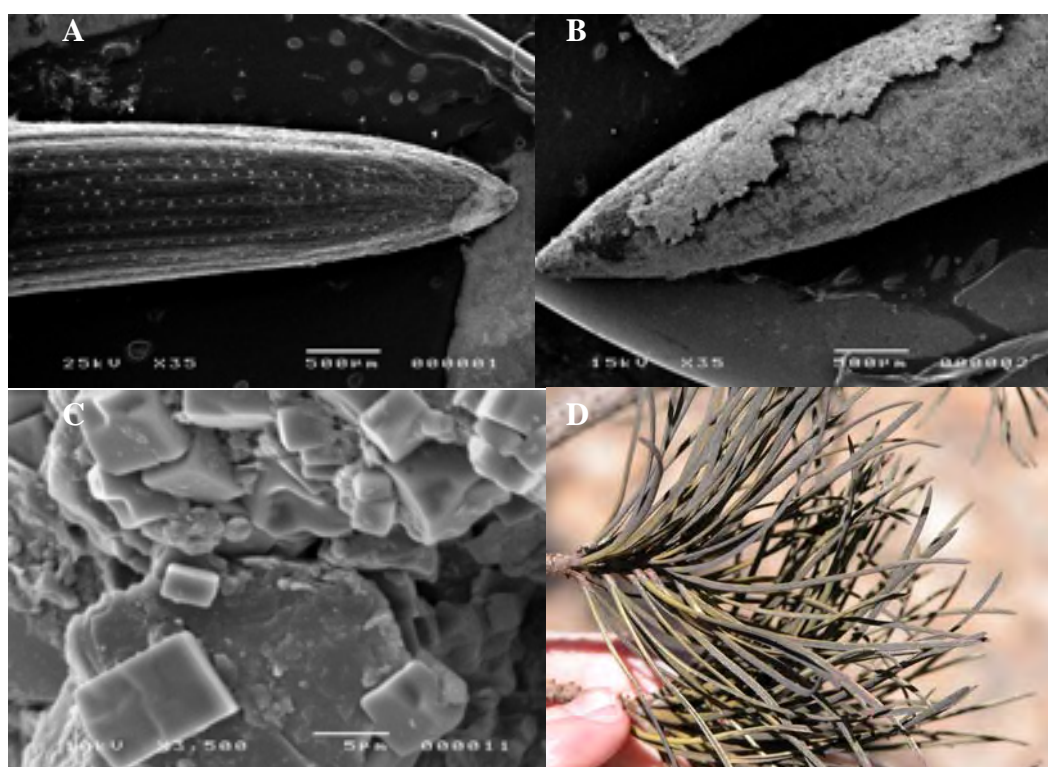

FIGURE 3 Needle surface deposits visible under SEM. Scale bars represent magnification from 50 μm to 500 μm : (a) uncoated lodgepole (*P. contorta*) needle tip with visible stomates; (b) heavily coated lodgepole (*P. contorta*) needle tip from a roadside tree along I-70 in Colorado; (c) highly magnified crystalline surface deposits on a lodgepole (*P. contorta*) needle from a roadside tree along I-70; and (d) visible deposits on ponderosa (*P. ponderosa*) needles, metro Denver, Colorado.

Photosynthesis and Drought Stress in Colorado Roadside Conifers

During the late winter and early spring, leaf-level photosynthesis rates in roadside trees ($\bar{x} = 7.6 \mu\text{mols CO}_2 \text{ m}^{-2} \text{ s}^{-1}$) were significantly reduced compared with their counterparts distant from the roadside ($\bar{x} = 8.45 \mu\text{mols CO}_2 \text{ m}^{-2} \text{ s}^{-1}$; $p < 0.05$). This finding concurs with other studies establishing that deicer salinity reduces the rate of photosynthesis in pines (19). Additionally, the presence of nonviable foliage and the premature abscission of foliage decreased the available photosynthetic area in many roadside trees (Figure 1b), and therefore the overall photosynthetic capacity of the tree. A decline in photosynthetic capacity in turn leads to decreased growth rates and a loss of plant vigor.

Measures of soil salinity such as pH ($R^2 = 0.32$, $p < 0.0001$) and soil Cl content ($R^2 = 0.20$, $p < 0.0001$) exhibited significant but moderate negative correlations with fall photosynthesis rates in conifers, indicating that soil salinity may inhibit tree physiology through osmotic stress. While negative correlations of photosynthetic rates and the presence of salt ions in plant leaf tissues have been reported in controlled experiments (28), these correlations were not found in this field study. However, photosynthesis may have been inhibited by the presence of a heavy coating of resuspended road particulates on the needles of study site trees, preventing the stomatal diffusion of water vapor and carbon dioxide (Figure 3b, d).

Drought stress in the roadside environment could not be linked to foliage injury in Colorado roadside conifers. No significant differences were observed in water stress as measured by leaf predawn water potentials between trees adjacent to the roadside or distant from the roadside in either the winter or throughout the growing season. Water stress also failed to significantly correlate with distance from the roadside, salt exposure or any measure of foliar injury. Ultimately, however, levels of precipitation and weather conditions over time will definitively influence deicer impacts on tree foliage health. Seasonal drought stress may exacerbate salt symptoms and foliar injury in trees by increasing soil osmotic stress or ion penetration into plant tissues, while salt levels in roadside soils can be ameliorated by high levels of precipitation (8, 9, 18).

Impacts of Pollution, Nutrient Availability, Disease, Pest, and Other Abiotic Damages on Roadside Conifer Health and Physiology

The surface profile of Colorado roadside soils was of relatively poor quality compared to soils further away from the roadside environment. Roadside soils exhibited significantly lower levels of major plant nutrients including total nitrogen, potassium, calcium, and phosphorus (Table 2). Additionally, soil organic matter and total organic carbon content was significantly reduced in soils adjacent to the roadbed compared to soils further away. Soil organic matter provides the major pool of nutrients for vegetation and greatly influences the physical, chemical, and biological properties of a soil. Reductions in soil organic carbon, phosphorus, and total nitrogen levels have correlated with reduced herbaceous biomass and diversity of perennial plant species (29). Leaching of base cations by sodium ions likely contributed to poor roadside soil quality across study sites. Sodium levels were significantly elevated in roadside soils along with significantly reduced levels of magnesium, potassium and calcium (Tables 1 and 2). Despite these differences, decreases in soil organic matter, total nitrogen, and potassium levels correlated significantly but only very weakly ($R^2 < 0.075$) with increased overall tree necrosis levels.

TABLE 2 Mean Significantly Different ($p < 0.05$) Plant Nutrients and Pollutants from Trees and Soils Adjacent to the Roadside and Distant from the Roadside, $n = 8$

	Roadside	Distant from Roadside
Soil N (ppm)	569.0	1,172.8
Soil K (ppm)	190.5	235.7
Soil Ca (ppm)	1,069.4	1,476.0
Soil P (ppm)	18.1	31.1
Soil organic matter (%)	2.67	5.7
Soil total organic carbon (%)	1.38	3.15
Soil Pb (ppm)	30.4	16.38
Needle total organic carbon (%)	50.4	51.2
Needle S (ppm)	943.0	785.3
Needle N (%)	1.17	0.96
Needle Cu (ppm)	4.15	3.34
Twig Pb (ppm)	0.58	1.09

Although significant degradation of nutrient status was observed in roadside soils, concomitant differences in plant nutrient levels between the needle tissues of roadside and distant trees was not observed (data not shown). Only total organic carbon in conifer needle tissue was significantly lower in roadside trees compared to their off-road counterparts (Table 2). Reduced organic carbon content in needle tissue correlated moderately with increased foliar injury ($R^2 = 0.23$, $p < 0.0001$), and may be related to reduced spring photosynthesis rates in roadside trees. Overall, these data suggest that in most cases, salinity in Colorado roadside soils does not appreciably affect nutritional balance in the shoot and leaf tissues of lodgepole and ponderosa pines.

Trees and soils along Colorado roadsides exhibited increased levels of pollutants and heavy metals compared to their counterparts away from the roadside environment (Table 2). Specifically, significantly elevated levels of sulfur, nitrogen, and copper in needle tissue, and lead in roadside soils were observed. Needle total sulfur concentrations have been linked to stomatal uptake of sulfur dioxides, and needle nitrogen concentrations to dry or wet deposition of atmospheric nitrous oxides (7). Nitrogen content in needle tissue was moderately positively correlated with crown necrosis ($R^2 = 0.20$, $p < 0.0001$), and may reflect this pollutant exposure. Reductions in leaf carbon content and increases in nitrogen and sulfur content have also been noted in trees of the evergreen oak *Quercus ilex* exposed to urban air pollutants (30).

Needle tissue sulfur and lead content correlated very weakly ($R^2 < 0.07$) with observed levels of foliar necrosis. Although a contribution to foliar injury is likely, changes in these factors explained only a small amount of the variation in crown necrosis compared to the accumulation of salt ions in plant tissues. In contrast, needle sulfur content correlated moderately with reduced photosynthesis rates ($R^2 = 0.39$, $p < 0.001$), suggesting that this pollutant exposure may contribute to some degree to physiological depression in roadside conifers. Acute exposure to sulfur dioxides has been previously shown to reduce photosynthesis in pine species (31).

Needle and soil cadmium contents, as well as soil copper levels and needle zinc contents also formed weak negative correlations with conifer photosynthesis rates ($R^2 \leq 0.10$).

Finally, study site trees exhibited only minor damage attributable to disease, insect, animal and abiotic injuries, which was unlikely to impact tree health and physiology (data not shown). Previous examinations of sodium-damaged ponderosa pines in Denver also exposed no fungi, insects, or nematodes that could be implicated as causal agents of foliar injury (15).

Comparing the Effects of NaCl- and MgCl₂-Based Deicers on Plant Health and Photosynthesis

Deicer exposure caused significant foliar injury in saplings of ponderosa (*P. ponderosa*) and lodgepole (*P. contorta*) pine during controlled greenhouse experiments (Figure 4a). Patterns of tissue necrosis in deicer-exposed saplings were similar between deicers types and corresponded with observed foliar injury in trees along Colorado highways (Figure 1c). Overall, exposure to the MgCl₂ deicer was far more deleterious to sapling health and physiology than exposure to NaCl sand and salt, with higher concentrations leading to complete sapling mortality (Figure 4a). As magnesium has not demonstrated appreciable phytotoxicity or significant correlations with foliage damage in the field, chloride exposure is the likely cause of sapling injury. In this case, chloride toxicity may be exacerbated due to the heavier concentration of chloride anions per application of MgCl₂ deicer compared with an equivalent application of NaCl sand and salt.

Strikingly, direct foliar contact with the MgCl₂ deicer was far more injurious to saplings than exposure to MgCl₂ through the soil matrix (Figure 4a). Saplings exposed in this manner exhibited severe and ultimately fatal necrosis at even the 10% concentration level (3% MgCl₂). In field studies, deicing salt exposure due to spray within 10 to 20 m (33 to 66 ft) of the road caused greater foliage damage than soil uptake alone (3, 18). Aerosolized MgCl₂ deicer appears to act equivalently to NaCl spray as a nonselective herbicide, with conifers demonstrating particular sensitivity.

Depression of photosynthesis rates and sapling mortality occurred with increasing MgCl₂ salt concentration exposure in both pine species, while trees exposed to NaCl sand and salt in contrast, exhibited little to no impact on photosynthesis rates, even at 100% roadbed application strength (Figure 4b). Overall, *P. contorta* saplings were relatively more sensitive physiologically to soil applications of MgCl₂ deicer, while *P. ponderosa* saplings were relatively more sensitive to foliar applications of MgCl₂ deicer (data not shown).

CONCLUSIONS

While many aspects of roadside environments may contribute to vegetation damage, injury to Colorado roadside trees correlated more strongly with levels of chlorides in needle tissues than any other factor examined in the study. In controlled experiments, deicer exposure in pines led to foliar injury, depression in photosynthesis rates, and sapling mortality. Equivalent amounts of a magnesium chloride-based deicer, especially when applied directly to sapling foliage, were far more damaging to conifers than exposure to a NaCl-based sand and salt mixture. The assertion therefore, that liquid MgCl₂-based deicers have no negative environmental impacts, or that they provide a more environmentally friendly alternative to NaCl-based sand and salt deicers for roadside vegetation is both inaccurate and misleading. Continued use of MgCl₂-based deicers

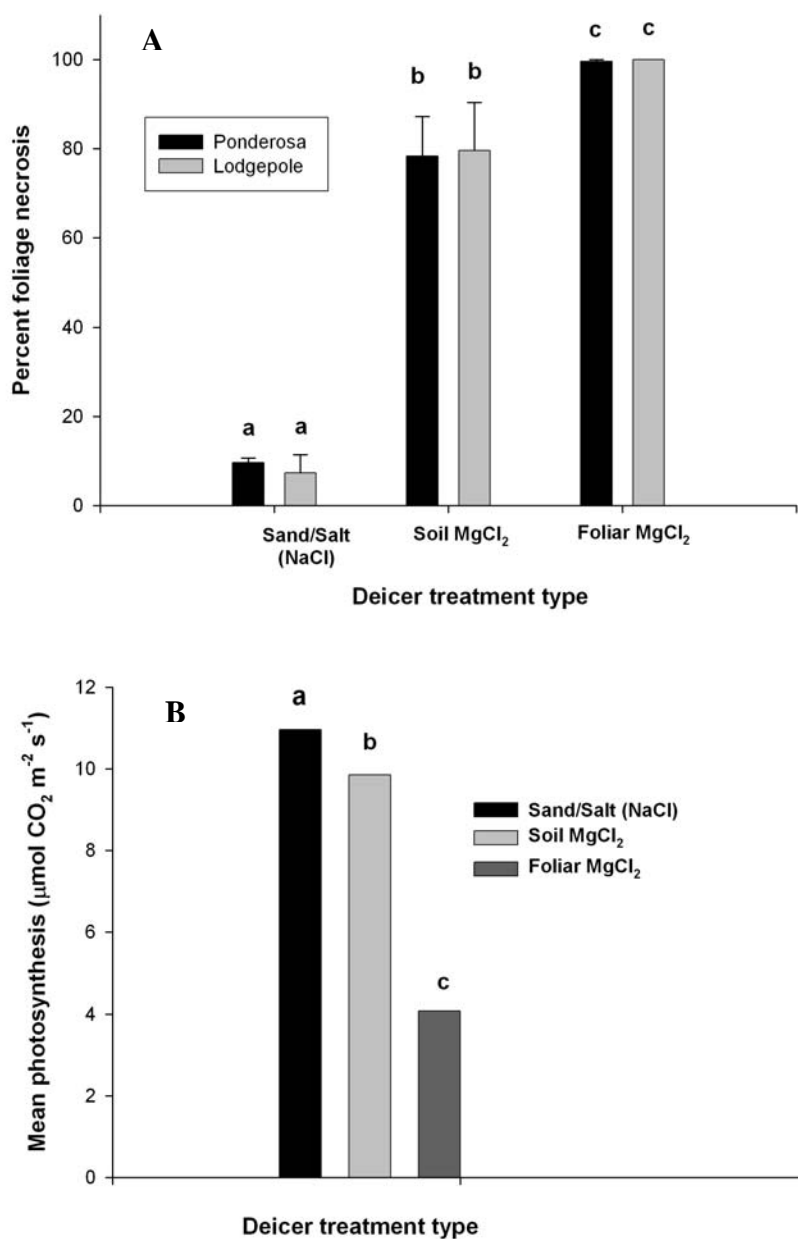

FIGURE 4 Foliage damage and photosynthesis rates in response to deicer treatment types in greenhouse-grown ponderosa (*P. ponderosa*) and lodgepole (*P. contorta*) saplings: (a) mean percent necrotic foliage in saplings exposed to full strength (100% road application concentration) deicer treatments, $n = 48$; (b) mean photosynthesis in both sapling species to varying deicer treatments over all concentration levels, $n = 96$.

should include recognition of the impacts on roadside vegetation, and warrants the exploration of mitigation efforts that will decrease vegetation exposure.

ACKNOWLEDGMENT

This work was supported by a grant from the Colorado Department of Transportation Research Branch.

REFERENCES

1. Westing, A. H. Plants and salt in the roadside environment. *Phytopathology*, Vol. 59, 1969, pp.1174–1181.
2. Hall, R., G. Hofstra, and G. P. Lumis. Effects of deicing salt on eastern white pine: foliar injury, growth suppression and seasonal changes in foliar concentrations of sodium and chloride. *Canadian Journal of Forest Research*, Vol. 2, 1972, pp. 244–249.
3. Bryson, G. M., and A.V. Barker. Sodium accumulation in soils and plants along Massachusetts roadsides. *Communications in Soil Science and Plant Analysis*, Vol. 33, Nos. 1 and 2, 2002, pp. 67–78.
4. Winter Driving, Frequently Asked Questions, Road Treatments. Colorado Department of Transportation. www.cotrip.org/winterdriving/faqroadtreatments.htm. Accessed November, 30, 2007.
5. Koebrich, M., and J. Wolf. CDOT's Solution May Be Sickening Trees. 9 News.com, July, 2007. www.9news.com/rss/article.aspx?storyid=74280. Accessed November, 30, 2007.
6. Harrison, R. M., and S. J. Wilson. The chemical composition of highway drainage waters I. Major ions and selected trace metals. *The Science of the Total Environment*, Vol. 43, 1985, pp. 63–77.
7. Grodzinska-Jurczak, M., and G. Szarek-Lukaszewska. Evaluation of SO₂- and NO₂-related degradation of coniferous forest stands in Poland. *The Science of the Total Environment*, Vol. 241, 1999, p. 115.
8. Jones, P. H., B. A. Jeffrey, P. K. Watler, and H. Hutchon. Environmental impact of road salting. In *Chemical Deicers and the Environment* (F. M. D'Itri, ed.), Lewis Publishers, Boca Raton, Fla., 1992. p. 1116.
9. Environment Canada, and Health Canada (eds.). Canadian Environmental Protection Act, 1999. Priority substances list assessment report. Road salts, 2001.
10. Norrstrom, A. C., and E. Bergstedt. The impact of road deicing salts (NaCl) on colloid dispersion and base cation pools in roadside soils. *Water, Air, and Soil Pollution*, Vol. 127, 2001, pp. 281–299.
11. Trahan, N., and C. M. Peterson. *Factors Impacting the Heath of Roadside Vegetation*. Report No. CDOT-DTD-R-2005-12. Colorado Department of Transportation Research Branch, 2007.
12. Bogemans, J., L. Neirinckx, and J. M. Stassart. Effect of deicing chloride salts on the ion accumulation in spruce (*Picea abies* (L.) sp.). *Plant and Soil*, Vol. 113, 1989, p. 311.
13. Pedersen, L. B., T. B. Randrup, and M. Ingerslev. Effects of road distance and protective measures on deicing NaCl deposition and soil solution chemistry in planted median strips. *Journal of Aboriculture*, Vol. 26, No. 5, 2000, pp. 238–245.
14. Kelsey, P. D., and R. G. Hootman. Deicing salt dispersion and effects on vegetation along highways. Case study: deicing salt deposition on the Morton Arboretum. In *Chemical Deicers and the Environment* (F. M. D'Itri, ed.), Lewis Publishers, Boca Raton, Fla. 1992, pp. 253–282.
15. Staley, J. M., J. Altman, and R. A. Spotts. A sodium linked disease of ponderosa pine in Denver, Colorado. *Plant Disease Reporter*, Vol. 52, No. 12, 1968, pp. 908–910.
16. Hautala, E. L., A. Wulff, and J. Oksanen. Effects of deicing salt on visible symptoms, element concentrations and membrane damage in first year needles of roadside Scots pine (*Pinus sylvestris*).

- Annales Botanici Fennici*, Vol. 29, 1992, pp. 179–185.
17. Kozłowski, T. T. Responses of woody plants to flooding and salinity. *Tree Physiology*, Monograph No. 1, 1997, p. 129.
 18. Viskari, E. L., and L. Karenlampi. Roadside Scots pine as an indicator of deicing salt use A comparative study from two consecutive winters. *Water, Air, and Soil Pollution*, Vol. 122, 2000, pp. 405–419.
 19. Bedunah, D., and M. J. Trilca. *Highway salting influences on ponderosa pine seedlings*. Report Agreement No. 16531CA. Rocky Mountain Forest and Range Experiment Station, Colo., 1977.
 20. Lewis, W. M. *Studies of environmental effects of magnesium chloride deicer in Colorado*. Report No. CDOTDTDR9910. Colorado Department of Transportation, Research Branch, 1999.
 21. Fischel, M. *Evaluation of selected deicers based on a review of the literature*. Report No. CDOTDTDR200115. Colorado Department of Transportation, Research Branch, 2001.
 22. Nicholson, K. W., and J. R. Branson. Factors affecting resuspension by road traffic. *The Science of the Total Environment*, Vol. 93, 1990, pp. 349–358.
 23. Blomqvist, G., and E. L. Johansson. Airborne spreading and deposition of deicing salt: a case study. *The Science of the Total Environment*, Vol. 235, 1999, pp. 161–168.
 24. Fitch, G. M., and D. Roosevelt. Environmental Implications of the Use of “Ice Ban” as a Prewetting Agent for Sodium Chloride. In *Transportation Research Record: Journal of the Transportation Research Board*, No. 1700, TRB, National Research Council, Washington, D.C., 2000, pp. 32–37.
 25. Spotts, R. A., J. Altman, and J. M. Staley. Soil salinity related to ponderosa pine tipburn. *Phytopathology*, Vol. 62, 1972, pp. 705–708.
 26. Connor, J. *Negative impact on vegetation from dust palatine*. Internal memo. Rocky Mountain National Park, Natural Resource Specialist, June, 1993.
 27. Cunningham, M. A., E. Snyder, D. Yonkin, R. Morgan, and T. Elsen. Accumulation of deicing salts in soils in an urban environment. *Water, Air, and Soil Pollution*, online first, DOI 10.1007/s11252-007-0031, 2007.
 28. Banuls, J., and E. PrimoMillo. Effects of chloride and sodium on gas exchange parameters and water relations of Citrus plants. *Physiologia Plantarum*, Vol. 86, 1992, pp. 115–123.
 29. Panchal, N. S., and A. N. Pandey. Study on soil properties and their influence on vegetation in western region of Gujarat state in India. Presented at 12th ISCO Conference, Beijing, China, 2002.
 30. Alfani, A., D. Baldantoni, G. Maisto, G. Bartoli, and A. Virzo-De Santo. Temporal and spatial variation in C, N, S and trace element contents in the leaves of *Quercus ilex* within the urban area of Naples. *Environmental Pollution*, Vol. 109, 2000, pp.119–129.
 31. Katainen, H. S., R. Karjalainen, E. Makinen, J. Jokinen, and S. Kellomaki. Effects of SO₂ on photosynthesis and peroxidase activity on Scots pine needles. *Forest Pathology*, Vol. 14, No. 1, 1984, pp. 33–42.

ENVIRONMENTAL STEWARDSHIP

Road Dust and Air Quality in Sweden**MATS GUSTAFSSON****GÖRAN BLOMQVIST****PER JONSSON***Swedish National Road and Transport Research Institute*

During the last years it has become evident that wear particles from road pavements, tires, brakes, and road maintenance strongly contribute to episodes with very high concentration of inhalable particles (PM₁₀) in outdoor air. These episodes normally occur during dry periods in winter and spring when accelerated wear and particle production occurs due to the use of studded tires and winter gritting. A lot of new knowledge about wear particles is needed in order to develop cost-efficient measures to deal with them. A great advantage is the possibility to study aerosols from each source both separately and in different combination in a controlled environment. At VTI (Swedish National Road and Transport Research Institute) a road simulator, previously used for pavement and tire wear studies, is used as a wear particle generator. Measurements of PM₁₀ in the road simulator hall have been used to study the influence of pavement properties, tire type, and vehicle speed on pavement wear. In several cities in Sweden, different winter maintenance chemicals (e.g., calcium magnesium acetate and magnesium chloride) have recently started to be used as dustbinders in springtime in order to abate the dust problem. Also other measures aiming at abating road dust concentrations are under way, including reduced studded tire use and speed reductions. In this paper compilations of results from several recent research projects and field case studies will be presented. Different pavements, tires, winter maintenance abrasive material, as well as measures like reduced studded tire wear and chemical dustbinding are discussed.

Air quality research in Sweden had not paid much attention to road dust until a study surprisingly showed that during periods with high concentrations of inhalable particles (PM₁₀), the bulk PM₁₀ originated in pavement wear and resuspension. It turned out that many street and road environments were facing problems regarding complying with the upcoming environmental quality standard for PM₁₀. These facts triggered a rather intense research effort to characterize road dust particles, determine their sources and find feasible measures to mitigate the problem.

Road dust in combination with winter traffic had previously been identified as an air quality problem in, e.g., Finland, Norway, and Japan. While Norway and Japan blamed the problem on the use of studded tires, Finland concluded winter gritting to be the main source. These differences have resulted in different research areas being prioritized and different measures being used.

This paper aims at compiling the main knowledge about the generation of road dust and how the road dust problem has been dealt with in Sweden.

SOURCES TO AND GENERATION OF ROAD DUST

Pavement and Tire Interaction

The interaction between vehicle tires and road pavement is the main process for road dust formation in the road environment. The relative contributions from pavement and tire depend on their properties. Tire properties play an important role in formation of wear particles in the road tire interface. There are several different types of tires, like summer, studded and nonstudded winter tires. Within these tire types there can be large differences regarding rubber mixture, thread pattern, and construction. Also tire age and size are important factors. All these properties, in combination with how the tires interact with a road surface during certain environmental conditions and driving situations, affect particle generation from both the tire itself and the road surface.

The pavement wear increases dramatically during wintertime when studded tires are used. Studs abrade the pavement stone material and only in Sweden more than 100,000 tons of pavement is worn off each winter (1). The PM_{10} fraction of this amount is not well known and is likely to vary depending on pavement characteristics.

A 3-year average emission factor for personal cars in a busy street in Stockholm is calculated to be 242 mg per vehicle km (2). The monthly averages vary, however, from approximately 100 during summer months up to 500 to 1,000 mg per vehicle km during spring months. This should be compared to the road wear, which for the actual street is approximately 2 g per vehicle km (private cars). This would give a PM_{10} fraction of up to 10% of the total wear.

An illustration of the high particle production using studded tires is given by studies using a circular road simulator Figure 1 (3). In this test, studded, nonstudded (friction) and summer tires were tested using in a standardized pavement and test cycle as PM_{10} were measured in the equipment hall. As can be seen in Figure 2 studded tires are vastly more effective in producing road dust particles from the road surface than any other tire type. It is also obvious from these experiments that increasing speed results in higher particles production.



FIGURE 1 The Swedish National Road and Transport Research Institute circular road simulator.

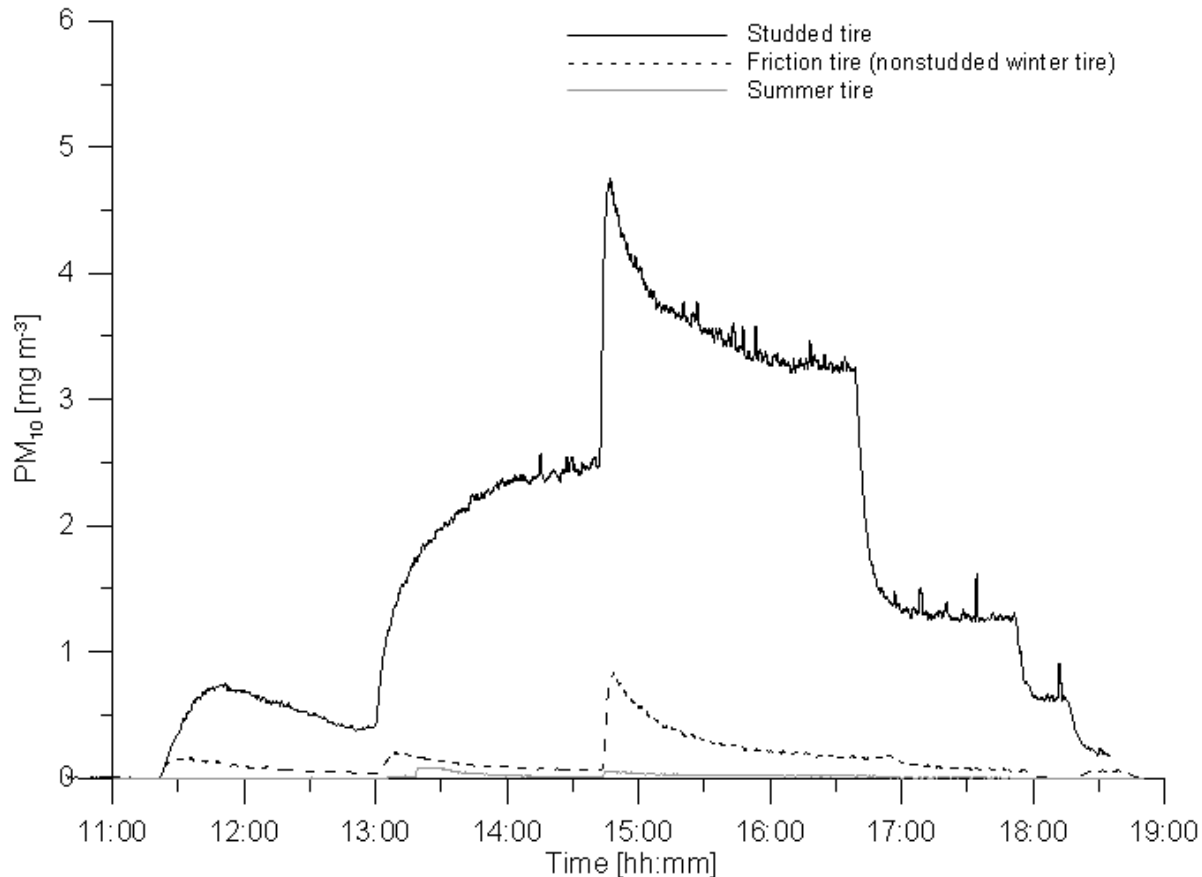

FIGURE 2 Measured concentrations of PM_{10} in a road simulator hall with different types of tires (studded winter tires, nonstudded winter tires, and summer tires). Road simulator speed was set to 30, 50, and 70 km/h successively.

As type of tire is important for the formation of PM_{10} , so are the pavement properties. In the same road simulator, three commonly used pavements in Sweden (granite <16 mm, quartzite <16 mm, and quartzite <11 mm) were studied with respect to particle generation (3). Figure 3 shows the results of measurements made during 1 h at 70 km/h with these different pavements. Two comparisons can be made. First, the difference between quartzite and granite pavements with the same maximum aggregate size is obvious (upper and middle lines). The granite pavement produces PM_{10} concentrations that are almost 70% higher in comparison to the quartzite pavement. The measured concentrations are, regardless of pavement extreme as a result of the confined hall. Second, the two pavements with similar (but originating from different quarries) stone material (quartzite), but with different maximum aggregate size (11 and 16 mm respectively), also exhibit large differences in resulting PM_{10} concentrations.

The total wear of a pavement normally decreases with increasing aggregate size (1). However, it can be seen in this experiment that the properties of the different materials seem more important than aggregate size since the pavement with the smaller aggregate size (quartzite <11) leads to less PM_{10} production than the coarser pavement (quartzite <16). Obviously, the

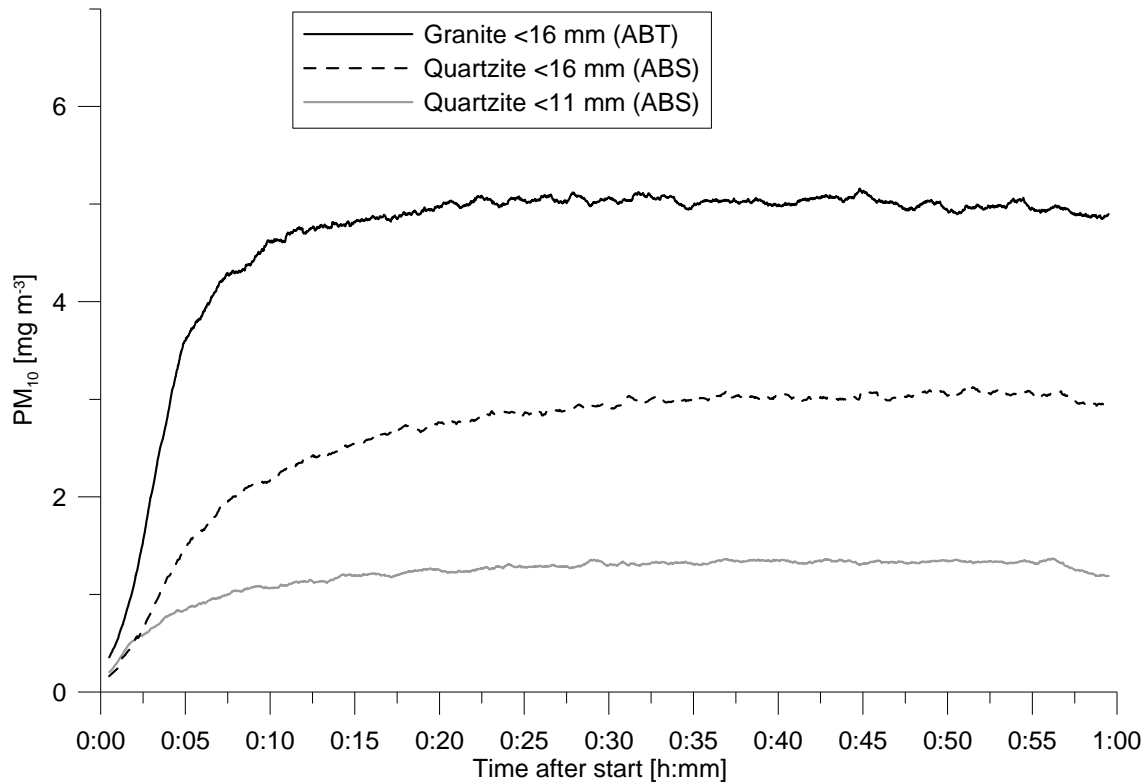

FIGURE 3 Measured concentrations of PM₁₀ in the road simulator hall with different pavements (granite <16 mm, quartzite <16 mm, and quartzite <11 mm) under controlled ambient conditions. Road simulator speed was set to 70 km/h. Studded winter tires were used.

properties deciding the PM₁₀ production are complex and interrelated. According to Räsänen et al. (4) the resistance against fragmentation and wear are the parameters that are usually thought to determine particle formation. Out of commonly used aggregate materials, Räsänen et al. found that volcanic rock is the most resistant to wear, while granite is much less resistant. Therefore, the latter should only be used for low quality applications. Ongoing research at VTI aims at clarifying the influence of stone size and material properties for PM formation.

Winter Gritting

Traction sanding is a common method to retain friction on roads in areas experiencing ice and snow conditions. Material properties such as size, shape and hardness are important for friction effect and duration. Both crushed bedrock and natural sand is used for traction sanding in a great range of size fractions. In Sweden, a questionnaire to 92 municipalities (5) showed that the mostly used traction material is natural sand 0 to 8 mm and crushed rock in fractions above 2 mm (2 to 4, 2 to 5, and 2 to 6 mm). Normally, rock or glaciofluvial material as nearby as possible is used for cost reasons, but material properties are equally important.

Traction sand is also a source for inhalable particulate matter and the material properties that affect friction and duration also affect the material's ability to disintegrate and produce PM₁₀ particles. Also, a material that is not sieved might contain PM₁₀ already when it is put on the

road, available for suspension by passing vehicles. Weathering and erosion processes can produce fine particle fractions in natural sand and also in stored crushed material exposed to weather.

Gertler et al. (6) calculated that 44% to 59% of PM_{10} originated in traction sanding and salting after a winter period when roads began to dry up. Kuhns et al. (7) found that PM_{10} emissions increased with 75% after traction sanding but had decreased to the same level as before the sanding after 8 h.

Traction sand is ground into finer fractions between pavement and tires by passing vehicles. At the same time the pavement is worn by the traction sand, producing particles. The latter effect is called the sand paper effect and was described by Kupiainen et al. (8). Their experiments in a road simulator showed that a dominant part of the airborne PM_{10} collected, originated from the pavement rather than from the traction sand. Räisänen et al. (4, 9) studied PM_{10} formation in relation to traction material properties. They found that material with bad fragmentation resistance produced more PM_{10} than material with good and that material initially containing smaller fractions (1 to 5.6 mm) produced more PM_{10} than coarser material (2 to 5.6 mm). Gustafsson et al. (10) showed similar results in experiments where unwashed natural sand (0 to 8 mm) produced markedly higher PM_{10} concentrations than washed crushed rock (2 to 4 mm) in a road simulator. In combination with studded tires both materials produced more PM_{10} than with friction tires (Figure 4).

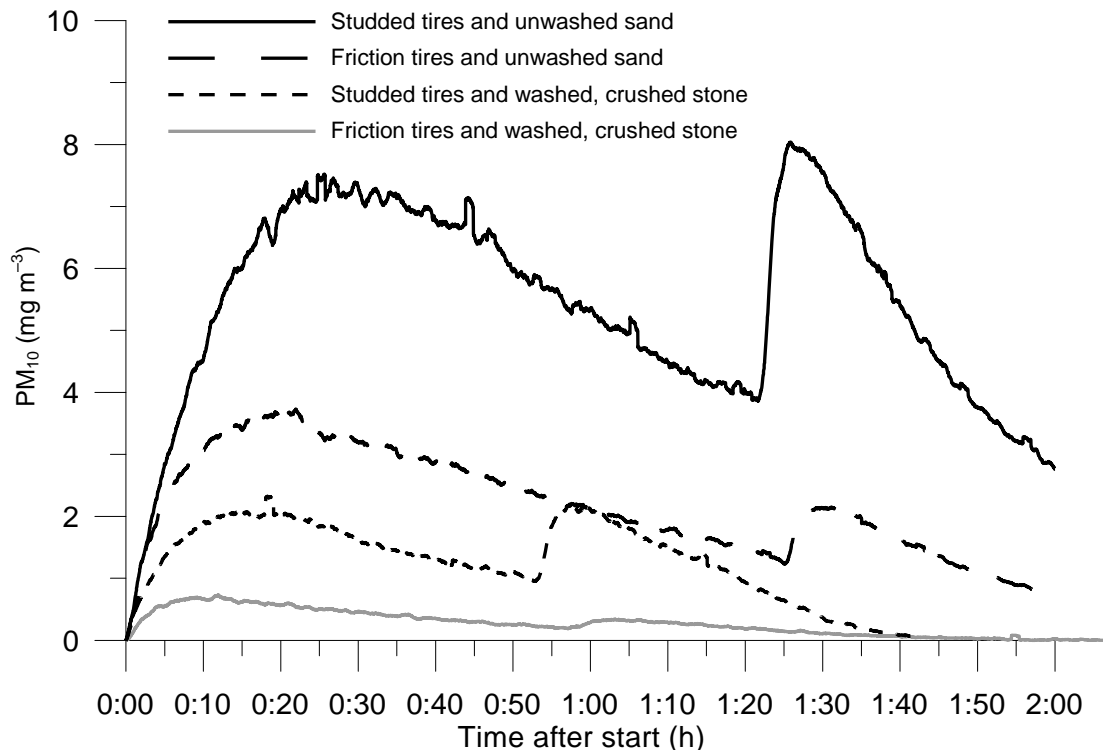

FIGURE 4 Measured concentrations of PM_{10} in the road simulator hall with studded and friction tires in combination with unwashed sand and washed crushed stone as gritting material. The secondary peak is formed when increasing the speed from 15 km/h to 30 km/h.

The importance of traction sand as a source for airborne PM₁₀ is likely to vary a lot in space and time. Since the material is rather quickly removed from the wheel tracks by passing vehicles the initial production may be high but short lived. Sand can be reentrained into the tracks by turbulence and vehicles running over sand deposits adjacent to the tracks, which will cause further particle production.

MEASURES AGAINST ROAD DUST

Measures Reducing the Production of Road Dust

As mentioned, studded tires have been identified as an important source for PM₁₀ production. They are also considered an important part of winter road safety in Sweden and Swedish pavements have for decades been constructed for maximum wear resistance. The health-related particle problem has triggered some reconsideration concerning the societal benefits of studded tires. In the measures programs to comply with the environmental quality standard, the cities of Stockholm, Gothenburg, and Uppsala have informed the public about the pros and cons of studded tire use and encouraged the use of nonstudded tires (Figure 5). Similar campaigns



FIGURE 5 Examples of winter tire campaign pamphlets. Left: “What’s spinning real fast, but can make your heart stop?” used in Uppsala in 2006. Right: “Winter tires. A small pamphlet about many questions” used in Stockholm 2007.

were used in Norway in the 1990s and were followed by studded tire fees in Oslo, Trondheim and Bergen, reducing the use of studded tires from 80% to about 30%. So far the Swedish campaigns are too recently launched to follow up.

The obvious differences in PM_{10} production from different pavements have led to research aiming at identifying the key pavement properties determining the production. So far, smaller maximum stone size seems to increase production when all other pavement properties are held the same. There is also a tendency, though not yet conclusive, that more wear-resistant stone material results in reduced PM_{10} production.

Since road wear as well as PM_{10} production increase with speed, speed reduction can be a feasible measure. So far, no tests have been performed in Sweden, but in Oslo (Norway) so-called environmental speed limits are being tested. These imply that the speed limit is lowered from 80 to 60 km/h on Riksveg 4 between November 1 and March 30. Results from the first winter show that while the actual speed reduction was between 11% and 14%, PM_{10} was reduced by 30% to 40% (Figure 6). Some of the PM_{10} reduction can probably be attributed to 2.9% less traffic and 10% less studded tire use (11).

Finnish and Swedish studies show that the quality of gritting material affects the PM_{10} formation from the material itself as well from the sand paper effect. In Finland, gritting material washed clean of fine fractions is in use in Helsinki as an air quality measure, but no follow-up studies of this specific measure are available. So far, measures including higher quality, washed gritting material have not been implemented in Sweden, even though proposed in some cities' measures programs.

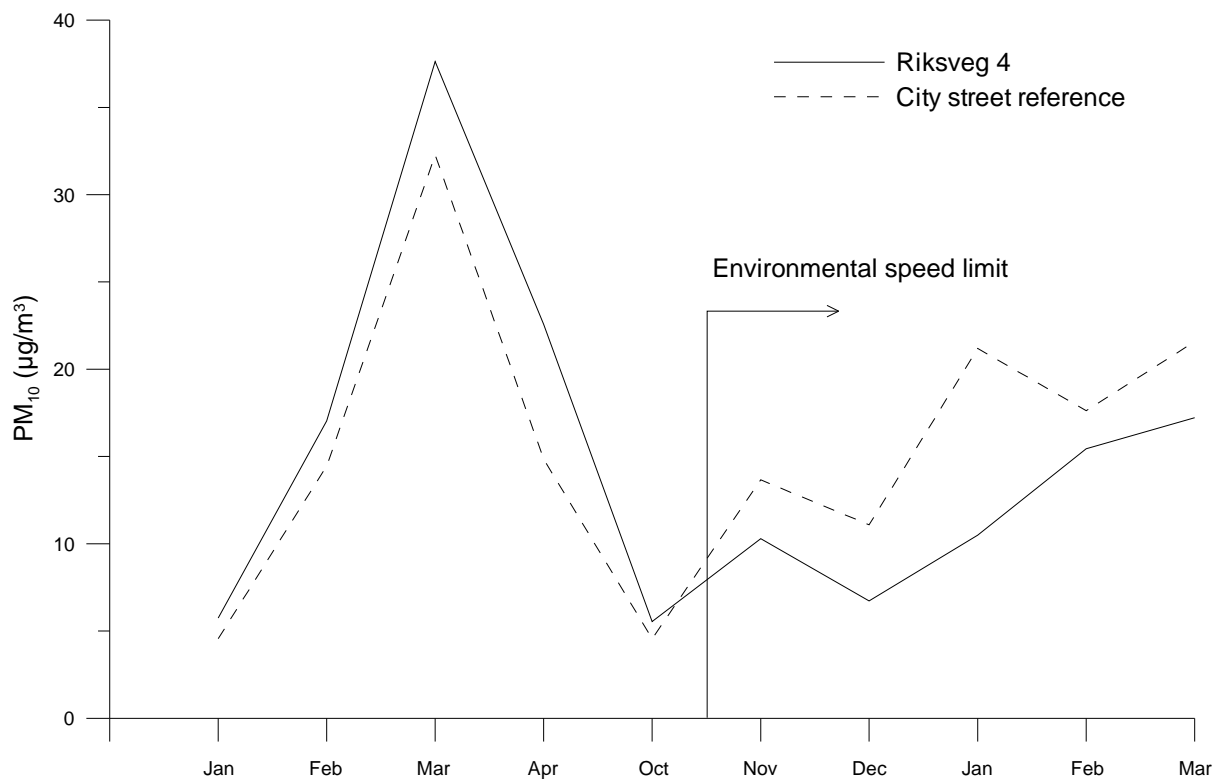

FIGURE 6 Effect of environmental speed limit in Oslo (after Hagen et al., 2005).

Measures Reducing the Dispersion of Road Dust

So far, measures in Sweden have been focussing on reducing the dispersion of road dust. The best known method to prevent already present road dust from being suspended from the road surface is dust binding. Calcium magnesium acetate (CMA), magnesium chloride ($MgCl_2$), as well as glucose solutions have been tested as dust binders. CMA is used since it has been showed to have a lower environmental impact than chloride salts. In Stockholm, tests have been made with CMA in both motorway and city street environments and also $MgCl_2$ on a motorway. Simultaneously, washing of the roadside with high pressurized water was tested as a measure. Results show that these dust binders are capable of reducing the PM_{10} concentrations by up to 30% to 40% the day after application. Studying the ratios between a CMA treated road section and a washed road section to an untreated road section reveals that dust binding is more efficient in reducing PM_{10} concentrations (Figure 7). In spite of these results, the effect is short lived and not sufficient for Stockholm streets to reach the environmental quality standard (12). Dust binding tests in other Swedish cities generally confirm these results also for $MgCl_2$ and glucose solution (13, 14, 15).

Reductions in speed and traffic amount have the advantage of reducing both the production and the dispersion of road dust. In the previous section an example of speed reduction effect on PM_{10} concentration was shown. Knowledge about the effect of traffic amount reduction on road dust PM_{10} is sparse. The Stockholm trials during 2006 involving a congestion tax resulted in the emissions of particles and nitrogen oxide from road traffic falling by 8% to 12% in Stockholm's inner city. For all road traffic in the City of Stockholm this corresponds to 3% to 5%. How much of the reduction that is related to road dust is unknown (16).

COMMENTS

The road dust problem in the Nordic countries is regarded as serious, since particulate pollution from local sources, to which the road dust is an important contributor, has been attributed to about 1,800 premature deaths brought forward each year with a life expectancy reduction of

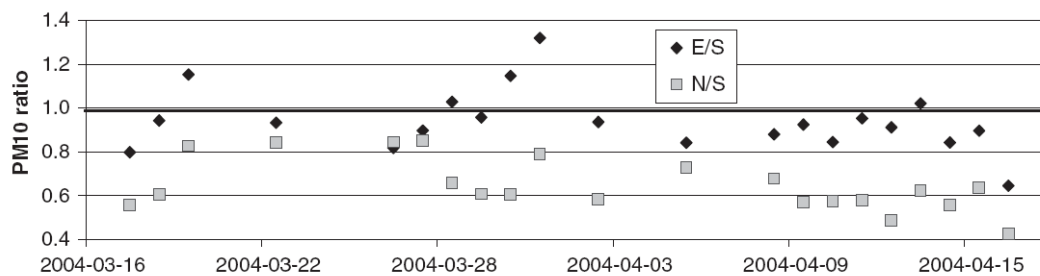

FIGURE 7 Ratio of the daily average PM_{10} levels at a washed stretch (E) and a CMA treated stretch (N) compared to an untreated motorway stretch (S) in spring 2004 [Norman and Johansson (12)].

about 2 to 3 months (17). The introduction of the environmental quality standard for PM₁₀ in January 2005 caused a sudden need for scientifically supported measures. Gradually, ongoing research is providing information on which such measures can be based.

The measure supposed to give the best effect on PM₁₀ emissions is reduced studded tire use. Since this measure has a direct relation to road safety, the debate is very animated concerning the adequacy of such a measure. The better friction of studded tires on smooth ice is balanced by negative effects on health and environment as well as increased noise and road maintenance costs. Even though studded tires has been shown to have better friction on certain road conditions, available accident statistics do not support any noticeable differences between studded and nonstudded winter tires during winter conditions (18). This might be due to insufficient data or data quality, but is also likely to be related to driver behavior effects. Only two socioeconomic studies have tried a holistic approach on studded tire use. A Norwegian study considered it optimal to reduce studded tire use in the four biggest cities, provided the frequency was not reduced in rural areas (19). A Swedish study (20) partly based on the Norwegian study (19) concludes that studded tires are socioeconomically beneficial if the toxicity of wear particles is negligible, studded tires have better friction on light snow and slush, and if the values used for risk of accident (21) are low, otherwise not.

To conclude, there are certainly many measures against road dust relating to both properties of materials and road operation as well as traffic measures such as tire use, speed and traffic amounts. The optimal solution to reduce road dust, without jeopardizing road safety and accessibility in a cost-efficient manner will most likely consist of different combinations of measures adapted for specific road or street environments.

ACKNOWLEDGMENT

The Swedish Road Administration is acknowledged for financially supporting several of the projects on which this paper is based.

REFERENCES

1. Jacobson, T., and F. Hornvall. Beläggningsslitage från dubbade fordon. VTI notat 44. Linköping, Sweden, 1999.
2. Johansson, C., M. Norman, G. Omstedt, and E. Swietlicki. Partiklar i stadsmiljö – källor, halter och olika åtgärders effekt på halterna mätt som PM₁₀. SLB Analysis Report 4:2004.
3. Gustafsson, M., G. Blomqvist, A. Gudmundsson, A. Dahl, P. Jonsson, and E. Swietlicki. Factors influencing PM₁₀ emissions from road pavement wear. *Proc., 6th International Conference on Urban Air Quality*, Limassol, Cyprus, March 2007.
4. Räisänen, M., K. Kupiainen, and H. Tervahattu. The effect of mineralogy, texture and mechanical properties of anti-skid and asphalt aggregates on urban dust. *Bulletin of Engineering Geology and the Environment*, Vol. 62, 2003, pp. 359–368.
5. Gustafsson, M., and J. Yakoub. Användning av vintersand i kommuner—en enkätstudie (in Swedish). VTI Notat (in press), Linköping, Sweden, 2008.
6. Gertler, A., H. Kuhns, M. Abu-Allaban, C. Damm, J. Gillies, V. Etyemezian, R. Clayton, and D. Proffitt. A case study of the impact of winter road sand/salt and street sweeping on road dust re-entrainment. *Atmospheric Environment*, Vol. 40, 2006, pp. 5976–5985.

7. Kuhns, H., V. Etyemezian, M. Green, K. Hendrickson, M. McGown, K. Barton, and M. Pitchford. Vehicle-based road dust emission measurement. Part II: Effect of precipitation, wintertime road sanding, and street sweepers on inferred PM 10 emission potentials from paved and unpaved roads. *Atmospheric Environment*, Vol. 37, 2003, pp. 4573–4582.
8. Kupiainen, K., H. Tervahattu, and M. Räisänen. Experimental studies about the impact of traction sand on urban road dust composition. *Science of the Total Environment*, Vol. 308, 2003, pp. 175–184.
9. Räisänen, M., K. Kupiainen, and H. Tervahattu. The effect of mineralogy, texture and mechanical properties of anti-skid and asphalt aggregates on urban dust, stages II and III. *Bulletin of Engineering Geology and the Environment*, Vol. 64, 2005, pp. 247–256.
10. Gustafsson, M., G. Blomqvist, A. Dahl, A. Gudmundsson, J. Lindbom, A. Ljungman, B. Rudell, and E. Swietlicki. Inandningsbara partiklar från interaktion mellan däck, vägbanor och friktionsmaterial. Slutrapport från WearTox-projektet. VTI Report 520, Linköping, Sweden, 2005.
11. Hagen, L. O., S. Larssen, and J. Schaug. Miljøfartsgrense i Oslo. Effekt på luftkvaliteten av redusert hastighet på rv 4 (in Norwegian). NILU Report OR 41/2005.
12. Norman, M., and C. Johansson. Studies of some measures to reduce road dust emissions from paved roads in Scandinavia. *Atmospheric Environment*, Vol. 40, 2006, pp. 6154–6164.
13. Johansson, C., M. Norman, and K.-G. Westerlund. Försök med dammbindning längs E4 och i Stockholms innerstad (in Swedish). SLB Report 6:2006.
14. Bouma, H., E. Bäck, and S. Sjöstedt. Effekter på partikelhalten av CMA-spridning och rengöring—en studie av E6 genom Gårda och Lundbytunneln i Göteborg. Göteborgs stad, Miljöförvaltningen (in Swedish), 2005.
15. Sandsveden, R., and D. Andersson. Mätning partiklar (PM₁₀) Östra Promenaden 1 januari 2007 – 30 juni 2007 (in Swedish). Norrköpings kommun, Report 4:2007.
16. SLB analys. The Stockholm Trial. Effects on Air Quality and Health. SLB rapport 4:2006.
17. Brunekreef, B., and B. Forsberg. Comparative Health Impact Assessment of Local and Regional Particulate Air Pollutants in Scandinavia. *Ambio*, Vol. 34, No. 1, February 2005.
18. Gustafsson, M., C. M. Berglund, B. Forsberg, I. Forsberg, S. Forward, S. Grudemo, U. Hammarström, M. Hjort, T. Jacobson, C. Johansson, A. Ljungman, O. Nordström, U. Sandberg, M. Wiklund, and G. Öberg. Effekter av vinterdäck. VTI Report 543, Linköping, Sweden, 2006.
19. Statens Vegvesen, Vegteknisk avdeling. Slutrapport fra Veg-grepsprosjektet - Veggrep på vinterveg (Final Report on the Road Grip Project). Allkopi, Oslo, Norway, 1998.
20. Angelov, E. I. The Studded Tire—A Fair Bargain. *Examensarbete i miljöekonomi*, Vol. 308, Institutionen för ekonomi, SLU, Uppsala, 2003.
21. SIKA. Översyn av samhällsekonomiska metoder och kalkylvärden på transportområdet (in Swedish). SIKA Report 2002:4.

Maintenance Decision Support Systems

MAINTENANCE DECISION SUPPORT SYSTEMS

Providing Winter Road Maintenance Guidance
*An Update of the Federal Highway Administration
 Maintenance Decision Support System*

KEVIN R. PETTY
WILLIAM P. MAHONEY III
JAMES R. COWIE
ARNAUD P. DUMONT
WILLIAM L. MYERS
National Center for Atmospheric Research

Controlling snow and ice buildup on roadways during winter weather events presents several challenges for winter maintenance personnel. Among these challenges is the need to make effective winter maintenance decisions (treatment types, timing, rates, and locations), as these decisions have a considerable impact on roadway safety and efficiency. Additionally, poor decisions can have adverse economic and environmental consequences. In an effort to mitigate the challenges associated with winter maintenance decisions, FHWA initiated a program in 2000 aimed at developing a winter road maintenance decision support system (MDSS). The primary goal of the MDSS program was to construct a functional prototype MDSS that could provide objective guidance to winter road maintenance decision makers concerning the appropriate treatment strategies to use to control roadway snow and ice during adverse winter weather events. It was envisioned that this prototype would also serve as a catalyst for additional research and development by the private sector. To date, five versions of the MDSS prototype code have been made freely available to the surface transportation stakeholder community, with the last release (MDSS Release-5) occurring in the fall of 2007. The FHWA MDSS prototype utilizes current weather observations and numerical model predictions from multiple sources to produce route-specific analyses and forecasts (48 h) of environmental conditions. Output from this process is used to drive an energy balance model to generate predictions of pavement conditions along each route of interest. Together, environmental and road condition information is used to construct recommended treatments, which are based on standard rules of practice for effective deicing and anti-icing operations. An interactive Java-based display is used to visualize graphic and text-based treatment recommendations, as well as diagnostic and prognostic atmosphere and road condition data. Through this interface, not only can users inspect the current recommended treatment strategies, but they can also investigate alternative courses of action and ascertain the anticipated consequences of action or inaction. Over the last three years, the MDSS prototype has been demonstrated in Colorado. During this period, the system was accessible to maintenance managers in the Denver metropolitan area. The multiple season demonstration provided a variety of disparate events on which to analyze system performance. As a result of the demonstration activities, the MDSS has undergone a number of recent improvements and refinements, and several lessons have been learned. This paper provides a comprehensive overview of the current FHWA MDSS prototype including the latest enhancements and changes.

Over the last several decades, there have been numerous advancements that have helped maintenance agencies more effectively mitigate the impacts that adverse winter weather conditions have on roadway level of service, including the introduction of more effective treatment alternatives, new types of treatment strategies (e.g., anti-icing, pre-wetting), and improvements in the equipment used to service roadways. However, two of the most important

factors related to optimizing treatment strategies are the ability to know the evolution of road weather conditions during a winter weather event and understanding how to employ this knowledge based on best practices for effective anti-icing and deicing. Until recently, the winter maintenance community has had to rely on conventional methods of acquiring, synthesizing, and applying road weather-related intelligence in the treatment decision process, which in some cases can result in information overload and poor winter maintenance decisions (treatment types, timing, rates, and locations).

In the late 1990s, FHWA Road Weather Management Program realized the need to address the challenges faced by the winter maintenance community in terms of effectively using road weather information in the maintenance decision making process, and in 2000, the concept of the maintenance decision support system (MDSS) was conceived. FHWA's vision was an automated end-to-end decision support system that had the capacity to provide users with diagnostic and prognostic weather and road condition information, as well as guidance about how to treat roadways prior to and during winter weather events. In an effort to create a system that would fulfill this vision, the FHWA initiated the MDSS project. During the course of the project, five national research centers have contributed to the development of a prototype MDSS. The participating laboratories include the Army's Cold Regions Research and Engineering Laboratory (CRREL), National Center for Atmospheric Research (NCAR), Massachusetts Institute of Technology–Lincoln Laboratory (MIT/LL), National Oceanic and Atmospheric Administration (NOAA) Earth System Research Laboratory (ESRL), and NOAA National Severe Storms Laboratory.

An initial version of the FHWA MDSS Functional Prototype (FP) was developed and released for public use in 2002. Since that time, there has been a considerable amount of MDSS-related research and development, which has resulted in four subsequent prototype releases. The system has been demonstrated each winter over the state of Colorado since 2004. These demonstrations have allowed researchers and engineers to monitor and track system performance, identify and target areas for improvement, and validate system enhancements. This paper describes the MDSS FP, with an emphasis on the latest version, Release 5.0. The paper also documents several of the principal changes and enhancements that have taken place since Release 2.0, which was reported on in 2004 (1).

FUNCTIONAL PROTOTYPE STRUCTURE

The original MDSS FP was designed using a modular framework. It was decided during the early phases of development that this type of development model would allow those responsible for setting up and operating the system to efficiently modify and update components without having to consistently augment other parts of the overall system. The modular framework also enables components to be easily added or removed, depending on the needs and requirements of the end user. Although the FP has gone through several revisions, the general foundation upon which it was designed still holds true today. The MDSS demonstrated in Colorado has utilized four primary components: (1) a numerical weather prediction system, (2) a road weather data forecast and data fusion system, (3) a road condition and treatment module, and (4) a Java-based display system.

The MDSS supplies the end users with strategic information in the form of hourly forecasts of atmospheric and road conditions out to 48 h at user-defined locations; forecasts are

updated every 3 h. Atmospheric predictions include, but are not limited to, forecasts of ambient air temperature, dew point temperature, wind speed, and precipitation occurrence, type, and rate. In an effort to account for the uncertainty in precipitation forecast, the system also provides probabilities of precipitation and conditional probabilities of precipitation type. Forty-eight-hour forecasts of road-related parameters such as road and bridge temperature, road mobility, and chemical concentration are also provided to decision makers.

Unlike previous versions of the MDSS, the current version has the capacity to deliver tactical environmental and road condition information. Decision makers can display and animate real-time radar and satellite data. These data not only allow users to track weather systems that will potentially affect their area of responsibility, but they also enable users to observe real-time, local conditions once the storm has commenced and determine which roadways are being most heavily impacted. In addition, the system is capable of generating tactical alerts, which are based on a combination of observed and forecasted data. These alerts notify winter maintenance personnel about current and near-term (0 to 3 h) conditions that may require action, such as the occurrence of frozen precipitation and forecasts of subfreezing pavement temperatures during precipitation events.

The MDSS FP combines predicted environmental and road condition information, along with standard practices for effective anti-icing and deicing, to derive route-specific treatment recommendations. Such treatments can be used by winter maintenance personnel as guidance as to what actions should be taken to maintain the highest level of service possible along each route of interest. The MDSS also supplies decision makers with information regarding the road conditions should one of three scenarios be followed: (1) no treatment is performed during the entire forecast period, (2) the recommended treatment is followed, or (3) a user-defined treatment plan is selected. In this way, users are presented with information that allows them to gauge the outcome of action or inaction. It should be noted that treatment recommendations generated by the MDSS FP can be tailored to fit the operations of a maintenance agency (e.g., chemicals used, route times, maximum and minimum application rates).

EXTERNAL DATA

The primary source of atmospheric forecast data for the demonstration MDSS is the National Center for Environmental Prediction (NCEP), which runs several numerical weather prediction models. Supplemental numerical forecast data are obtained from NOAA's ESRL. In addition to numerical model data, real-time observations of weather and road conditions are acquired and used in the FP. These data originate from roadway weather information system environmental sensor stations (ESSs) and automated observing platforms located at airport facilities. These observing stations are operated by several organizations including the U.S. government, state departments of transportation (DOTs), local municipalities, and roadway authorities. More recently, remotely sensed data (radar and satellite) have been utilized in the MDSS to provide users with information concerning regional environmental conditions.

Although output from numerical prediction systems such as the North American Mesoscale, Global Forecast System, and Rapid Update Cycle models has been used in the MDSS for several seasons, the MDSS is not confined to using a particular model(s) to generate weather forecasts. Nor is the MDSS FP restricted to using forecasts that are generated via automated

means. The system is designed to be flexible enough to adapt to data sources and forecasts available from both public and private weather providers, as well as maintenance agencies.

A software package known as the local data manager facilitates the acquisition of much of the data used in the FP, while a data assimilation process is used to extract relevant data and derive the additional data fields needed for system operation. Select data sets are then forwarded to downstream algorithms and modules such as the Road Weather Forecast System (RWFS), Road Condition and Treatment Module (RCTM), and the Java-based display system (Figure 1).

All forecast and observation data are ultimately placed in a data store that is accessible to internal MDSS processes and external display clients. Data are accessed by display clients via the Treatment Update Network Layer (TUNL) or Thematic Real-Time Environmental Distributed Data Services (THREDDS) mechanisms. The THREDDS server provides gridded data such as satellite and radar, while the TUNL is the interface that provides all other observation and forecast data.

In the latest MDSS FP, static geographic information systems data such as state and county maps and road and topography data are no longer hard-wired into the display. These data are now accessed dynamically at run-time from a Web Map Service (WMS) server. The raw data and how they are to be displayed are configured on the server. This allows far more flexibility in relocating the system to a new geographic domain, as well as allowing the system to display data on different special scales.

ROAD WEATHER FORECAST SYSTEM

Figure 1 shows a system overview of the MDSS Release 5.0, as it pertains to how the system has been set up and run for the most recent Colorado demonstration. Weather forecasts are generated using RWFS, a fuzzy logic-based suite of techniques and algorithms developed at NCAR. The RWFS uses a combination of numerical model forecasts, statistical predictions, and climatology and real-time observations to produce optimized forecasts at user-defined locations and lead times. This is accomplished using a technique that tracks the performance of each forecast module. Each forecast module (e.g., numerical model) produces an independent forecast; the consensus forecast skill is improved using a scheme that automatically adjusts the weighting of the inputs from each module based on recent performance and then integrates the individual inputs to create the final consensus forecast (2).

There are several key advantages to this approach including the capability to (1) utilize as many or as few input analysis/forecast products or techniques as desired, (2) easily accommodate the addition or removal of data or product inputs, (3) adaptively weight component forecast techniques according to their proven performance for specific conditions and locales, (4) easily adapt to missing data or apply automatic quality control processes for input data or weather products, (5) incorporate human forecaster experience and “rules of thumb” into the system via weighting procedures, (6) adapt and evolve the system easily from one regime to another, where conditions and major forecast influences vary, and (7) establish a dynamic link between forecast verification and component weighting to systematically evolve the weighting of input components.

Although the RWFS has been an instrumental element of the MDSS FP demonstrations, it is not considered to be part of the FP and is no longer distributed with other MDSS components. It is available from NCAR upon request. Its sole function is to generate and deliver

the environmental forecasts used to drive core MDSS modules. It is not required that the RWFS be used as a source for weather forecasts; however, a surrogate, automated or manual, is needed to produce the required time series forecasts valid at user-defined locations. These time series may be human-generated forecasts or may be derived from a single or from multiple numerical models; the origin of the forecasts is at the discretion of the system operator.

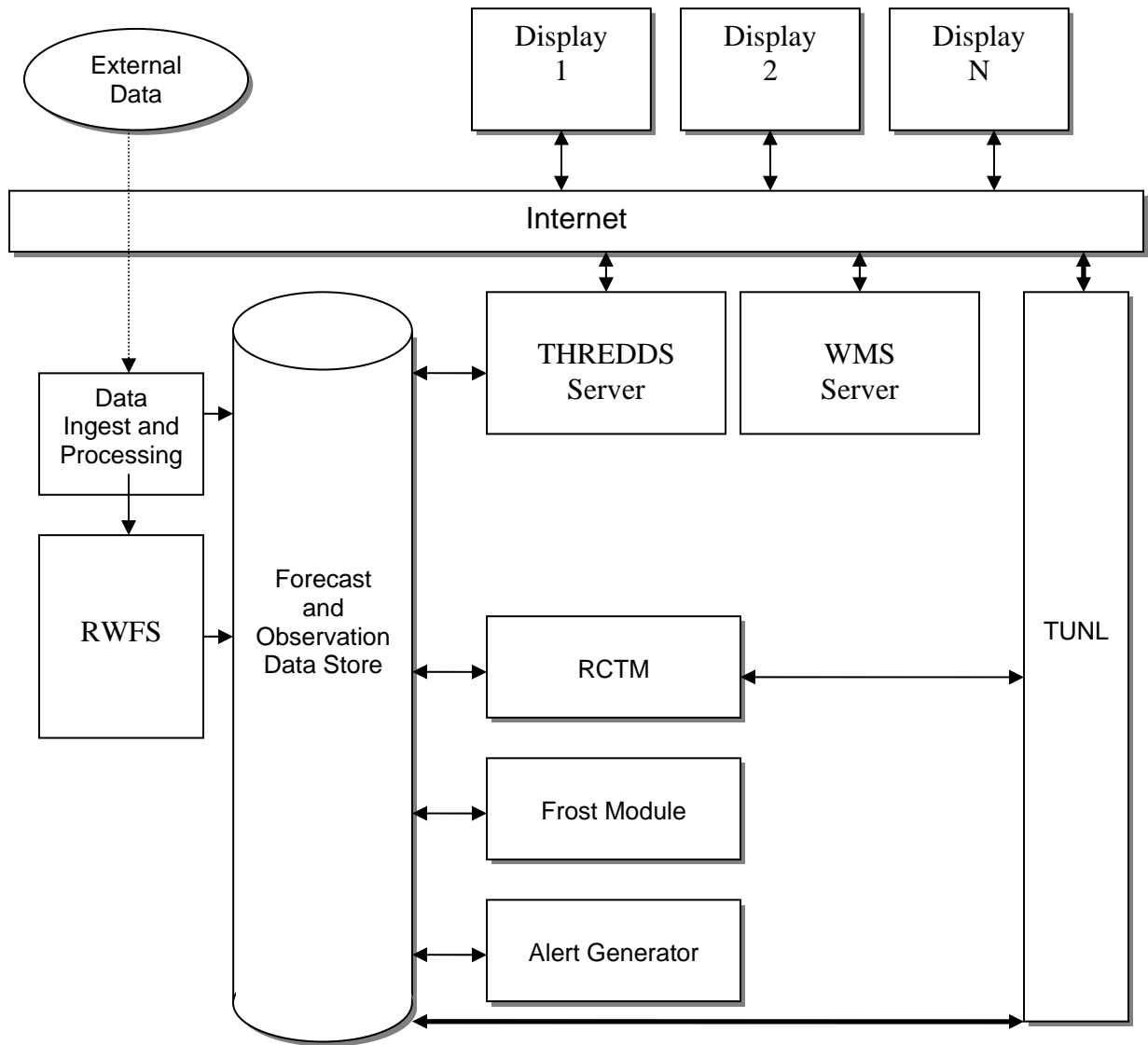

FIGURE 1 MDSS FP system data flow overview.

ROAD CONDITION AND TREATMENT MODULE

RCTM is considered to be the focal point of the MDSS, as its function is to produce road condition forecasts and treatment recommendations (Figure 1). A detailed depiction of the RCTM is provided in Figure 2. Note that the RCTM comprises several modules including a road temperature and snow depth module, net mobility module, rules of practice module, and chemical concentration module.

During winter demonstrations, the RCTM has been run and tested on a small number of forecast sites along user-defined routes. Weather forecasts and roadway observations (e.g., ESS observations) valid at a forecast site, along with roadway characteristics, are used as input into the road temperature module. Output from the road temperature module is used in conjunction with the weather forecast to characterize the road weather conditions over the next 48 h. Based on this information the system generates a net mobility index, which is a simple nondimensional metric used to identify the predicted state of the roadway relative to winter road conditions.

Forecasted road weather conditions are also used to recommend appropriate road treatment strategies for winter maintenance personnel, when necessary. As previously noted, the RCTM has been designed to determine road conditions and recommend treatment actions in three different modes: (1) no treatment, (2) recommended treatments, and (3) user-defined treatments. The no-treatment mode assumes that no action (i.e., treatment) is taken, and information is provided to the user concerning the state of the roads if no maintenance action takes place. The second mode, the recommended treatment mode, determines the most appropriate course of action based on anticipated road weather conditions and best practices for anti- and deicing (3). In the user-defined treatment mode, users can specify alternate treatment plans (what-if's) in an effort to examine what happens to the state of the road under different scenarios. When a user selects a treatment plan, whether it is the system recommended plan or a user-specified treatment plan, the system stores this information and uses it to calculate the road conditions and subsequent treatment actions.

When a treatment plan or recommendation is selected, the chemical concentration module is used to track and estimate the concentration of anti-icing and deicing chemicals on the roadway. This entails having knowledge regarding the amount of chemical applied to the roadway surface and the amount of precipitation that occurs. After the onset of precipitation, a chemical will begin mixing with the available surface water to form a chemical solution. As precipitation continues to fall, the chemical concentration will continue to decrease, reducing the overall effectiveness of the chemical. Other factors such as evaporation and solution drainage will also influence chemical concentration. The chemical concentration module attempts to capture the essential aspects of the chemical application–dilution process.

In the last few years, the RCTM has undergone a number of substantial modifications. These enhancements include the incorporation of a new model to forecast road temperatures and conditions. Additionally, numerous enhancements have been made to the treatment recommendation process including, but not limited to, new chemical types, treatment logic, and rules of practice. The following sections outline many of the more prominent RCTM improvements.

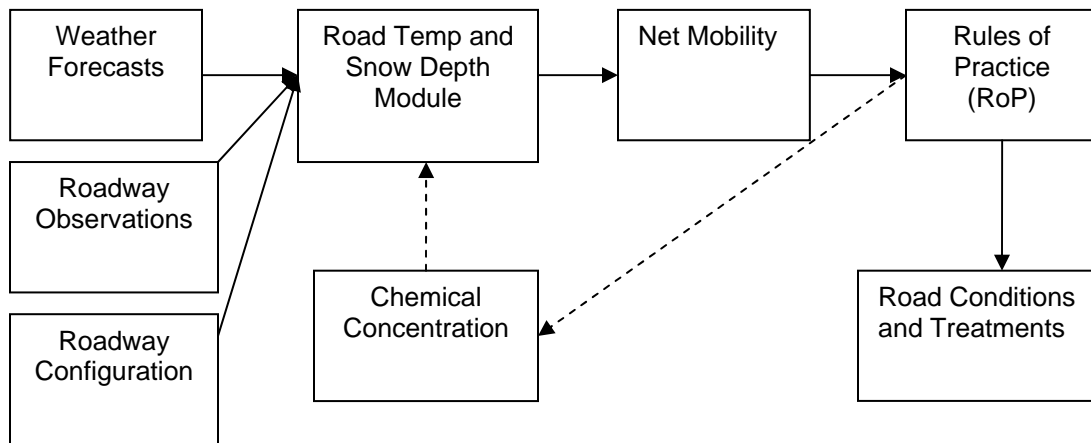

FIGURE 2 RCTM data flow diagram. Dashed lines indicate the data flow if the rules-of-practice module determines that a treatment is required.

Road Temperature Model

Previous versions of the RCTM relied on a land-surface model called SNTHERM to forecast pavement temperatures and subsurface profiles. SNTHERM is a FORTRAN-based, one-dimensional energy and mass-balanced model developed at CRREL in the 1980s. In recent years, CRREL has shifted its focus to a newer road temperature model [Fast All-Season Soil Strength (FASST) model]. As a result, a study was conducted to find a suitable replacement model for SNTHERM, since this model will no longer be supported. FASST and the Model of the Environment and Temperature of Roads (METRo) were identified as potential replacements. METRo is an operational model developed and used by the Meteorological Service of Canada, and it has been designed specifically to forecast local pavement temperatures (surface and subsurface) and road conditions (4). The investigation into a replacement model focused on several criteria including forecast performance, code stability, support, efficiency, and ease of use. In the end, the decision was made to incorporate METRo into the RCTM.

METRo, which is a physically based model, forecasts the evolution of pavement temperatures and accounts for precipitation accumulation on roads (liquid and solid forms) by solving the energy balance at the road surface, as well as the heat transfer process within the substrate material. In determining the surface energy balance, METRo examines and computes short, longwave, and turbulent fluxes, as well as the flux related to the phase change of precipitating water. METRo also attempts to account for anthropogenic contributions (e.g., heat from vehicles). A one-dimensional heat diffusion equation serves as the basis for computing the subsurface temperature profile, with key parameters being heat capacity and ground heat flux. METRo is capable of computing profiles for both roads and bridges. Finally, METRo has the capacity to simulate liquid water and snow or ice on the pavement surface by tracking and

calculating key elements such as precipitation, evaporation, and runoff. The removal of snow resulting from the traffic can also be parameterized in the model (4).

Like other models, METRo does have some weaknesses; two of the most notable are the amount of time it takes to run the model and the need for an observation history at each forecast site. While SNTherm and FASST take approximately 0.2 s to generate a 48-h forecast, METRo takes roughly 2 s. This can be attributed to the fact that METRo uses the industry standard XML format, and the parsing of XML input files and writing the XML output files takes a significant amount of the processing time. It's estimated that METRo's input-output process takes up roughly 90% of the processing time. METRo also requires an observational history of the surface and, if available, subsurface observations. Using this history, METRo develops its own estimate of the current subsurface temperature profile. At least a 3-h history is required and 12 h is preferred, which can present challenges at nonobserving sites. Nonetheless, the strengths of METRo clearly outweigh its weaknesses.

METRo exhibits a number of traits that make it attractive in terms of the MDSS FP and the technology transfer process. Not only does METRo perform well under a number of disparate road weather conditions, but experience has also shown that it is extremely easy to acquire, install, and use, even for novice users. Moreover, the support provided by the developers, along with an expanding community of end users, will ensure that problems or issues that do arise can be addressed and corrected in a timely manner. It should be noted that METRo is open source software distributed free of charge by Environment Canada. A wiki (<http://documentation.wikia.com/wiki/METRo>) has been established to facilitate the use of METRo by sectors of the road weather community.

Rules of Practice

Based on feedback and lessons learned from early MDSS field demonstrations conducted in Iowa, as well as demonstrations in Colorado, MIT/LL perform a considerable amount of research and engineering in an effort to enhance the Rules of Practice (RoP) module. MIT/LL rewrote the RoP code, essentially removing the software layer between the RoP and RCTM, to make the interprocess communication smoother and more robust. Together, NCAR and MIT/LL tested and updated the RoP during multiple Colorado demonstrations. In addition, winter test cases were used to simulate different scenarios to exercise various sections in the code. These activities have resulted in software that is more compact, stable, and flexible, with the capacity to better meet the needs of the winter maintenance community.

During Colorado field demonstrations more than one agency was utilizing output from the MDSS. Consequently, parameters that had been set only once in processing (chemical type, pretreatment strategy, and minimum-maximum chemical values) needed to be set for each agency. In an effort to enable further flexibility, the code was modified to allow these parameters to be set not just for each agency, but for individual routes. This change allows the system to provide treatment plans based on a wide variety of strategies, even within a single agency.

Earlier versions of the RoP used simplified curves to essentially automate the treatment look-up from the FHWA tables. This latest version of the RoP, however, utilizes both the eutectic curves directly and the dilution information from the chemical concentration module to more accurately estimate the amount of chemicals needed on the road surface to keep snow and ice from bonding. Treatment recommendations are now driven by dynamically calculating chemicals needed based on expected chemical dilution and hourly forecasted weather and road

conditions. This process benefits from the development and implementation of a storm characterization module, which was added to better categorize pre-, in-, and post-storm weather and road conditions. To further improve the treatment recommendation process, the RCTM tracks the expected amount of available water on the road surface and the phase of the water (e.g., snow, ice, wet), improving the RoP logic and enabling the system to protect against critical situations such as surface water refreezing post-storm.

The reconfiguration of the MDSS for operation over Colorado shed light on the need for the system to support additional chemical types, since some maintenance agencies in Colorado use newer products such as Caliber and Ice Slicer in treating roads. As a result, additional eutectic curves were added to the RoP to handle these chemical types. Currently, the system supports five different chemical types: (1) sodium chloride, (2) calcium chloride, (3) magnesium chloride, (4) caliber, and (5) ice slicer. Furthermore, the form of the treatment chemical (dry, pre-wet, and liquid treatments) can be entered explicitly by the user (either as the preferred treatment type or in the user and what-if treatment strategies). Chemical splatter off the road and dilution rates are modified by the chemical form entered (liquids splatter less, but dilute faster).

Support for the application of multiple chemicals was added allowing users to select user-defined treatments that apply more than one chemical during a storm. System recommended treatments, however, are still only capable of single chemical recommendations (except for pre-treatment). An option was also added to allow users to configure the treatment strategy that their operation employs: continuous or triggered operations. Continuous operations are when trucks are deployed continuously during the precipitation phase of a storm regardless of current treatment effectiveness. Triggered treatment strategy refers to operations that deploy treatments only when either the chemicals are ineffective or the snow is at a plowable depth.

Finally, blowing snow potential is now considered in the development of treatment plans (higher blowing snow potential yields higher treatment recommendations). The RoP also provides textual output that describes the reasoning behind the development of the recommended treatment plan.

FROST MODULE

The MDSS development team worked to refine and implement a frost potential product based on work conducted at Iowa State University (5). The product uses METRo to calculate pavement temperatures. The forecasted air temperature, dew point temperature, wind speed, pressure, precipitation rate, and the Iowa State algorithm are used to calculate frost deposition. The forecast data are interpolated for each site to create a minute-by-minute forecast over the entire forecast period for each variable. Because the occurrence of frost is very sensitive to small errors in environmental conditions (that is, a small change in air or dew point temperature can result in a switch from favorable to unfavorable frost conditions), a Monte Carlo statistical technique is applied to the primary data inputs (surface, air and dew point temperatures, and wind speed) to calculate the uncertainty in those predictions. The variations used are based on appropriate standard deviations for each variable. An interest function is applied to the frost depth returned from the Iowa State algorithm and a weighted average of these interest values is calculated. The weight given to each frost occurrence estimate emulates the statistical probability of that combination of events happening. The likelihood of frost is calculated and mapped to the MDSS alert categories (OK, marginal, poor, and extreme).

ALERT GENERATOR

The Alert Generator is a module that calculates weather and road alerts based on current observations and forecasts. Alerts are designed to be simple notifications of predetermined hazardous weather or road states that are either occurring at the present time or will be occurring in the next few hours. They are intended to attract the attention of users so that they can examine the condition in more detail. Alerts are generated on a route-by-route basis and are binary in nature, that is, for each route, an alert condition either exists or does not exist.

There are two types of alerts currently implemented in the MDSS: weather alerts and road alerts. Weather alerts are based on precipitation reports from observation data such as METARs and provide real-time indication of potentially adverse weather. A weather alert is generated when snow or freezing precipitation is reported at or near a specific route. Weather alerts are updated as new observation data are received. Road alerts are more predictive in nature and use the most recent road condition forecasts to determine if an alert is warranted. A road alert is generated for a route if the road temperature is anticipated to go below freezing and precipitation is expected, or if the road is currently wet and the road temperature is expected to go below freezing. Road alerts are updated each time a new forecast is available and are valid until the next forecast update.

SYSTEM DISPLAY

The MDSS display application provides an interactive display of data generated by upstream components (e.g., the RWFS, RCTM). The display is a Java-based application that resides on an end user's computer and is invoked through Java WebStart from Sun Microsystems. This allows the display to be run on a variety of platforms. The application obtains data and information from a remote server; this process is handled by a web server that interfaces with the TUNL in response to requests made by the display application (Figure 1). The display system enables the user to

1. Ascertain whether adverse weather or road conditions are predicted to occur in the future (current forecast period is 48 h);
2. View forecasted and observed weather information at user-defined forecast sites;
3. View forecasted and observed road condition information at each user-defined maintenance route or zone;
4. Be alerted to potential real-time and near-term road weather hazards;
5. Verify forecast performance (air and road temperature, relative humidity, and wind speed);
6. View archived events, including weather and road condition forecasts, observations, treatment recommendations and selected treatment actions;
7. Calculate winter maintenance treatment plans for each route or zone;
8. Assess the predicted impact of system recommended treatment plans;
9. Perform what-if scenarios to assess the impact of user-defined treatment plans; and
10. View recommended and selected treatment history (previous 6 h).

The latest version of the MDSS display was completely revised. While much of the look and feel remains the same when compared to previous versions, the underlying code base was ported to an entirely new Java visualization framework. The new framework provides better support for asynchronous data retrieval, time selection, and emerging standard data formats. Data layers may be added or removed easily. Maintenance districts and management areas may now be nested or overlapped. The same display may be used for real-time planning and archival event reviewing.

The display system reads output data from the forecast and observation data reformatters and provides the user with various derived views of the data. In the initial state maintenance area view displayed in Figure 3, the state alert zones on the map are color coded for the worst weather forecasted for the next 48 h. This is the view presented to the user upon display startup. In addition, the display system provides several other high-level alerts of forecasts for inclement weather, impaired road conditions, blowing snow, and bridge frost. At this display level, the user can determine whether the alert information warrants further investigation. If so, the user can choose to select one of the preconfigured maintenance area views. These are indicated in a combo box located in the upper-left corner of the display. When a maintenance area is selected in the combo box, the map is zoomed to that area and the alerts are updated to reflect only the roads and forecast points within that maintenance area.

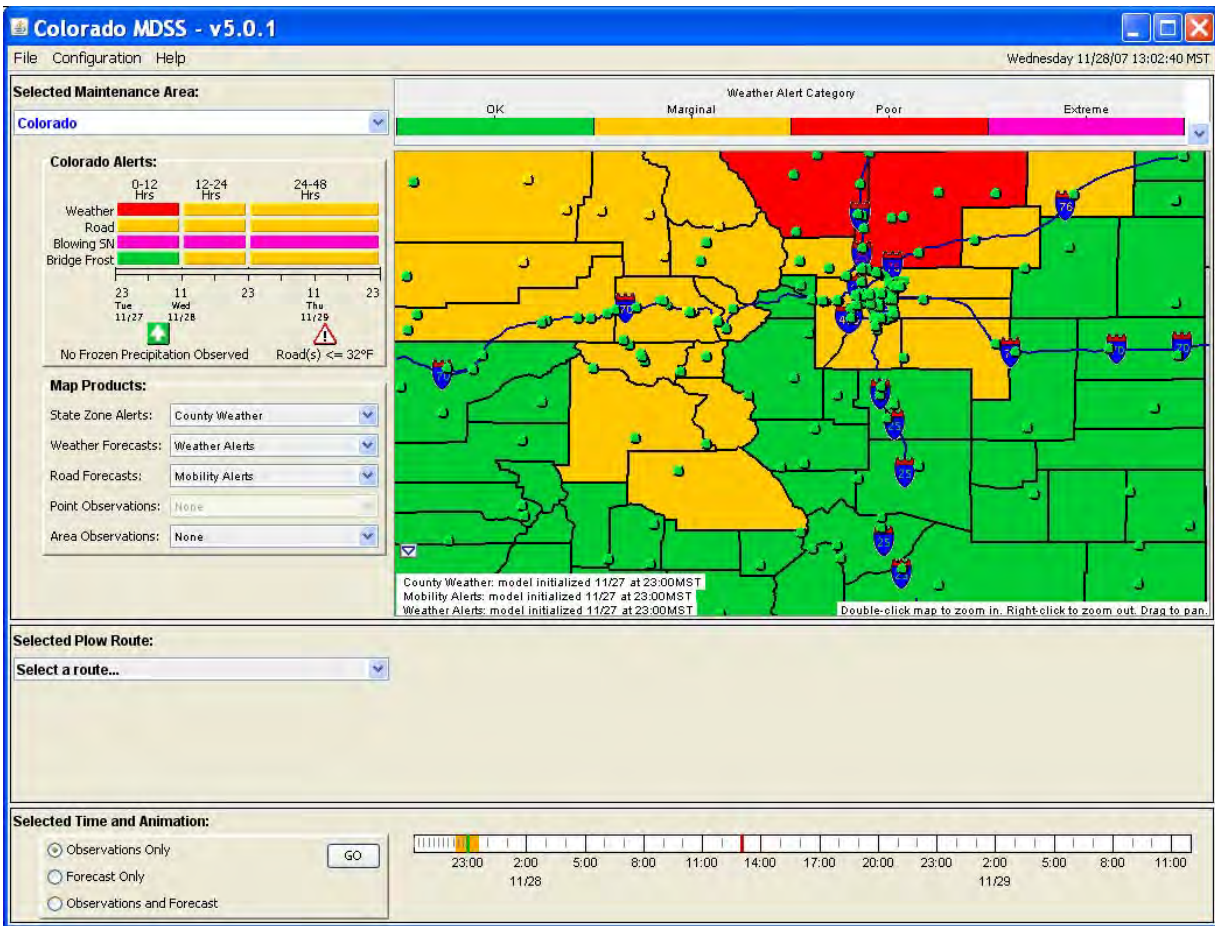

FIGURE 3 Example MDSS FP state view for Colorado.

Figure 4 displays the E-470 Public Highway Authority Maintenance District. From this view, users can investigate current and anticipated road weather conditions that are valid for the district. All of the data sets listed in the map products panel to the left of the map may be independently enabled and disabled. The weather forecasts combo box controls the visibility of the weather variables such as air temperature, relative humidity and snow accumulation, while the road forecasts combo box controls the visibility of the road variables, including road and bridge temperature and snow depth. The point observations combo box controls the visibility of the observed variables (e.g., ESS data), and the area observations combo box controls the visibility of the radar and satellite data sets.

Weather and road forecast charts can be accessed by clicking on a user-defined forecast point or road segment, respectively. As an alternative, a summary of predicted weather and road conditions is provided in the event summary dialog. There is an event summary dialog available for each route in the system, and it provides an overview of key forecasted parameters, including but not limited to road temperatures, total snow accumulation on the road, conditional probabilities of rain, snow, and ice, as well as the total probability of precipitation and the declared precipitation type.

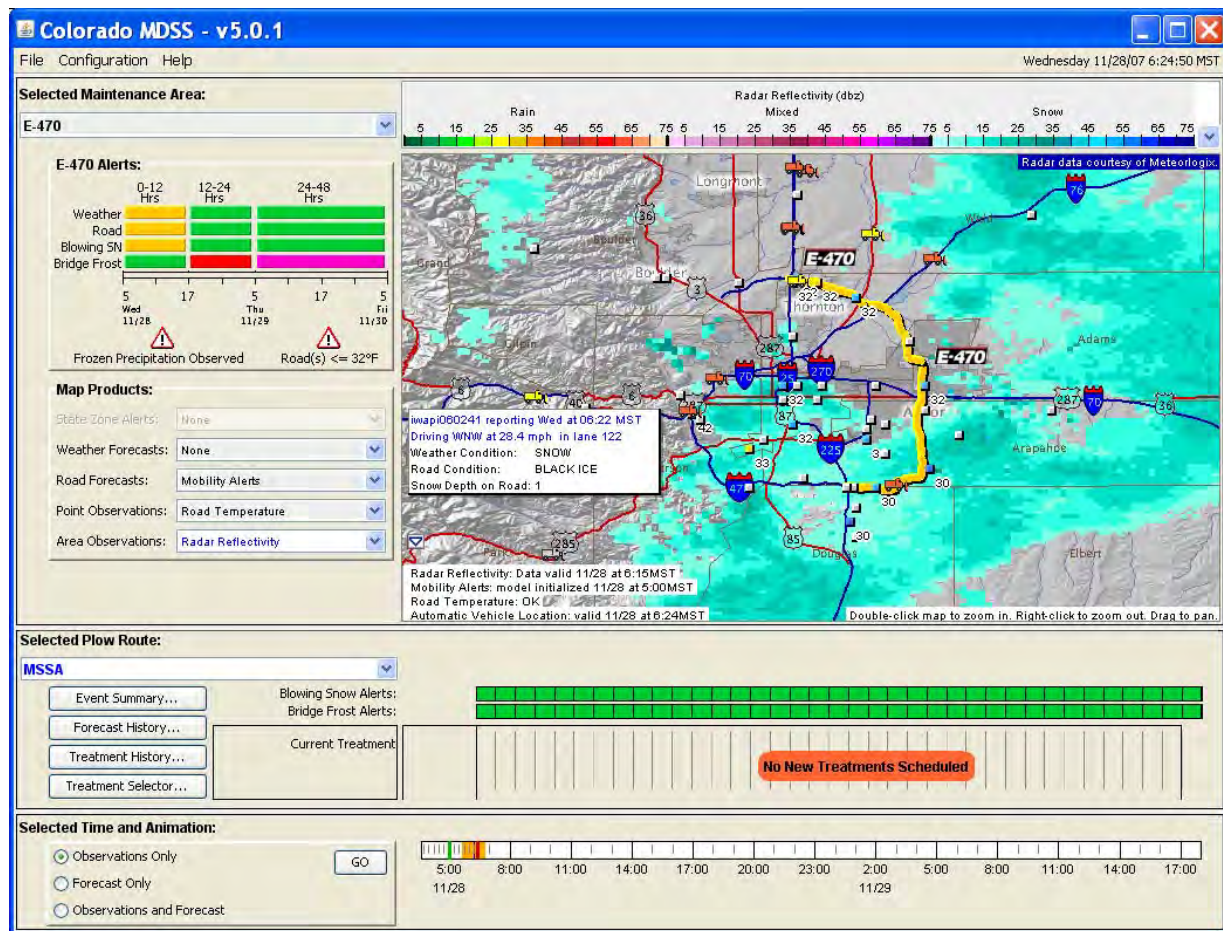

FIGURE 4 E-470 Maintenance district. Displayed data include pavement temperatures, mobility alerts, radar data, and automatic vehicle location information.

The treatment history dialog for each route displays the recommended and last-selected treatments for the current 3-h run and the two previous 3-h runs. The information is presented in graphical or textual format, as desired, and as with many of the dialogs, the contents may be printed.

Road treatment functionality is provided in the treatment selector dialog. This dialog allows users to get a recommended treatment for each of the road segments modeled in the MDSS system. It also allows users to test user-specified treatments for each segment. If the user is satisfied with the results of a treatment scenario, the user can select it for use in operations. The user may also opt to select one of the other scenarios for use in operations. In either case, the display adjusts the road condition alerts to reflect the predicted road conditions based on the selected treatment (Figure 5).

Figure 4 also demonstrates several of the key display enhancements that have been incorporated into the MDSS FP during the last development cycle. One of the major extensions is the ability to display gridded products such as radar and satellite data, which can be used to support tactical maintenance operations. These data are distributed by a THREDDS server and are loaded in one of the emerging standard meteorological data formats, netCDF. In the example contained in Figure 4, radar data indicating the location and intensity of snow are displayed.

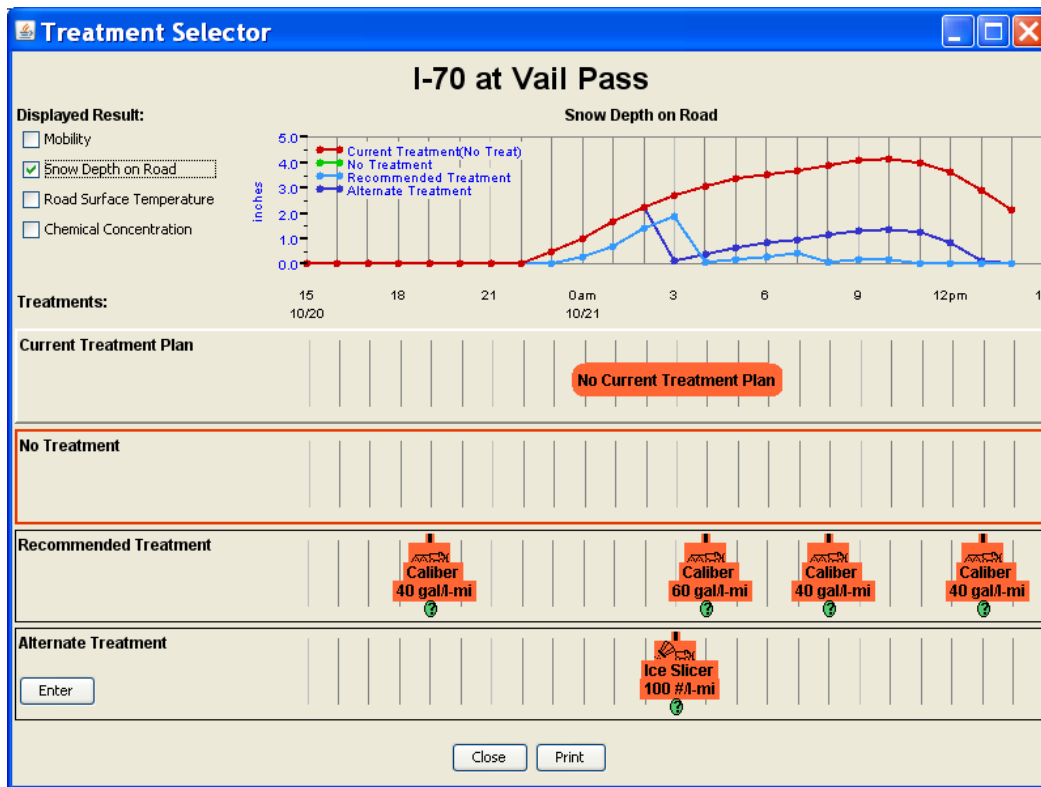

FIGURE 5 An example of the MDSS FP treatment selector dialog. This dialog allows users to select and modify treatment plans, as well as view the predicted results of their action or inaction. Note that select buttons do not appear in this image, as this image was produced in archive mode. In real-time mode, these buttons would be available to the user.

Another major extension is the support for dynamic basemaps. These maps show the appropriate resolution of roads, political boundaries, and topographic detail for the current pan and zoom. Mapping functionality also allows arbitrary zooming and panning using a double-click to zoom in, a right-click to zoom out, and a click-drag to pan.

The configuration menu provides access to several useful features. The show trucks menu item enables the display of automatic vehicle location data for all trucks that have reported within the desired time range: the last 12 h, the last 24 h, or any time, allowing managers to view vehicle location, speed and direction, treatment, and observed weather and road conditions. Only the latest report from each truck is shown. Tooltip (i.e., mouse over) inspection of trucks yields a table containing all available details from the truck report (Figure 4).

Overall, the new display is far more localizable than its predecessors. All local configuration is specified in files separate from the application source code. Recompile would not be required to move the display from one state to another. Nearly all data layer configuration is specified in a single XML file. Geographic data are dynamically requested using the web map service WMS protocol, and road segments and alert zones are specified in Shapefile format.

TECHNOLOGY TRANSFER

One of the fundamental goals of the MDSS project is the development of an MDSS prototype that will serve as a catalyst for additional research and development, accelerating the time to market for MDSS capabilities. The enhancements and upgrades discussed here have been carried out in support of this goal. Many of the features and functions that now make up the current MDSS FP were developed and implemented with feedback from a wide range of stakeholders. It is recognized that not all of the capabilities desired by the winter maintenance community have been incorporated into the prototype, as this was not part of the vision of the project. However, the code is sufficiently mature to facilitate the development of a more complete road weather system.

Under the direction of the FHWA's Road Weather Management Program, each release of the MDSS FP code has been made freely available to the public. The intent is to promote a process by which private sector companies, together with potential MDSS end users (DOTs, local municipalities, etc.), can use the FP as leverage to construct fully operational versions of the system. This can be achieved by using all or portions of the MDSS code as a starting point or using the MDSS concept and system design as a template for development. The success of this approach can be seen in the increased interest by the maintenance community in MDSS-related technologies, as well as the development and deployment of MDSS capabilities by commercial vendors.

The current MDSS prototype has been demonstrated in Colorado for the past few years. The MDSS development team has relied on these demonstrations as a way to test the system in real time, investigate its performance, and identify needed changes. The enhancements that have been made as a result of these demonstrations, as well as feedback from the winter maintenance community, have culminated in the development of MDSS Release 5.0. As with past MDSS releases, the FHWA is distributing this release to the public on a nonexclusive basis. MDSS project information, technical documentation, and Release 5.0 are available from the MDSS website, which can be found at http://www/ral/ucar/edu/projects/rdwx_mdss.

SUMMARY

FHWA funded and directed the development of a prototype system capable of providing guidance to winter maintenance personnel regarding what treatment actions to take based on the anticipated road weather conditions. To date, five versions of the MDSS FP have been developed and released, and the maintenance community is beginning to see a shift in the winter maintenance operations paradigm, including the strategic planning and tactical response processes.

The enhancements made to the FHWA MDSS FP during the last few years have resulted in a very comprehensive winter maintenance support system capable of being used as a foundation for operational MDSS capabilities. The success of the MDSS project can be measured by the fact that several private sector companies have begun developing operational versions of the MDSS. However, it should be noted that more research and development is needed in order to develop end-to-end MDSS capabilities that are able to meet all of the needs and requirements of the winter maintenance community, with key areas being improved road weather forecasts, mobile data integration, and assessment of current and emerging treatment chemical effectiveness. As more commercial vendors work with the winter maintenance community to develop and implement MDSS-related technologies, MDSS capabilities will be improved, leading to a high level of performance and, ultimately, widespread adoption of the technology by winter maintenance practitioners.

ACKNOWLEDGMENTS

The FHWA Office of Transportation Operations Road Weather Management Program sponsors this project. The MDSS development team is grateful for the leadership provided by Paul Pisano, Pat Kennedy, and Andy Stern (Noblis). The MDSS team would also like to thank the City and County of Denver and the E-470 Public Highway Authority for supporting and participating in Colorado field demonstrations. In particular, the team would like to acknowledge William Kennedy (City of Denver) and Terry Gowin (E-470).

The MDSS FP development has involved several U.S. national laboratories. In recent years, much attention has been given to refining and enhancing the MDSS RCTM. The authors would like to recognize the efforts made by Robert Hallowell (MIT/LL), since without his contributions, these enhancements would not have been possible.

REFERENCES

1. Pisano, P. A., A. D. Stern, W. P. Mahoney III, W. L. Myers, and D. Burkheimer. Winter Road Maintenance Decision Support System Project: Overview and Status. In *Transportation Research Circular E-C063: Sixth International Symposium on Snow Removal and Ice Control Technology*, Transportation Research Board of the National Academies, Washington, D.C., 2004, pp. 3–17.
2. Mahoney, W. P., and W. L. Myers. The Winter Road Maintenance Decision Support System (MDSS) Project Update and Future Plans. Presented at the 19th Conference on Interactive Information and Processing Systems, American Meteorological Society, Long Beach, Calif., 2003.

3. Federal Highway Administration. *Manual of Practice for an Effective Anti-icing Program: A Guide for Highway Winter Maintenance Personnel*. Publication FHWA-RD-95-202. FHWA, U.S. Department of Transportation, 1996.
4. Crevier, L., and Y. Delage. METRo: A New Model for Road-Condition Forecasting in Canada. *Journal of Applied Meteorology*, Vol. 40, 2001, pp. 2026–2037.
5. Greenfield, T. Bridge Frost Prediction by Heat and Mass Transfer Models. MS thesis, Iowa State University, 2004.

MAINTENANCE DECISION SUPPORT SYSTEMS

Development of Winter Maintenance Support System

Overview and Status

NAOTO TAKAHASHI
ROBERTO A. TOKUNAGA
MOTOKI ASANO

Civil Engineering Research Institute for Cold Region

In snowy, cold regions, keeping travel safe, effective, and efficient during the wintertime is an important theme and road administrations conduct various snow and ice control operations to provide as good roadway conditions as possible. With the limitation of budgets and the high expectation of the public, it is necessary to conduct winter maintenance operations more efficiently. Our institute has undertaken developing the winter maintenance support system to improve the productivity and efficiency of winter maintenance management and its practices. The system, known as the maintenance decision support system, has been developed to be suitable for Japan's geographical features, weather, and existing snow and ice control activities. This system consists of weather forecasts and the prediction of road surface temperature and condition. Furthermore, the system has been developed and improved in cooperation with other relevant organizations. The project began observing the weather and road surface temperature and developing the prediction model in 2004, and in 2005 the prototype started experimentally providing the information while improving the model and interface as the need arises. This paper describes the conceptual framework of this information system and status of the project. The paper also details the practical/operational situation as well as the evaluation of the system.

In cold, snowy regions, with wintertime comes the potential for icy, slippery roadways, and snowfall and snow accumulation lead to narrowing roads. These winter conditions result in negatively affecting traffic performance on roadways. Road authorities have developed and implemented a variety of practices and techniques for better snow and ice control to minimize winter hazards and make travel safer and more reliable. However, while the snow and ice control budget has limitation, it is required to implement more effective and efficient snow and ice control operations and treatment activities.

In order to contribute to more efficient winter maintenance operation, the Civil Engineering Research Institute for Cold Region (CERI), Japan, has engaged in developing the winter maintenance support system, also well known as the maintenance decision support system (MDSS), that has provided information on road weather and road icing to road authorities since 2004. Then, since the winter of 2005–2006, its test operation has been started for the national highways in Sapporo, and the system has been practically used while improving the interface as the need arises.

The rest of this paper is organized as follows. The next section presents the summary of the system development, and the third section describes the system's composition and function. The fourth section discusses the state of the system, and the final section summarizes the study results and suggests subjects for future inquiry.

SUMMARY OF WINTER MAINTENANCE SUPPORT SYSTEM

Background of System Development

Accurate forecasting of road surface icing is essential to the adequate and appropriate application of winter road surface management programs. For instance, anti-icing operations are a proactive preventive approach that needs to be applied early enough to keep ice from forming (1); otherwise, it requires forecasting road-surface conditions accurately for winter maintenance decisions.

Such effective operations require developing an approach to predict road icing scientifically as road surface condition changes suddenly with rapidly changing climate conditions, such as radiative cooling phenomena. Besides, in order to form operational crews by prior decision or to start operational work at the appropriate time, forecasting information must be provided to road authorities as soon as possible. This might lead to more appropriate and more efficient winter maintenance.

Such a system providing road weather information and forecasting information on road surface conditions to road authorities is known as the roadway weather information system (RWIS) or MDSS (2, 3). In order to support road authority's decision with providing accurate forecasting information based on a scientific approach, our institution has undertaken development of a winter maintenance support system suitable for Japan's geographical features, weather, and existing snow and ice control activities.

Organization of System Development

The winter maintenance support system has been developed in cooperation with not only the road authority but also academic and weather institutions. Figure 1 shows the cooperation status with the agencies and institutions concerned.



FIGURE 1 Cooperation with the agencies concerned.

Summary of System

Figure 2 shows the conceptual diagram of the winter MDSS developed in this study and the process of how to provide forecast information is described as follows along the diagram.

Data Collection

Measurement devices are placed at the study point to observe weather and road surface temperature. The study also obtains on-the-spot weather data and prediction data, such as amount of solar radiation, clouds, and humidity, from the meteorological agency.

Data Intensive

The meteorological data and road surface temperature data obtained at the study point are recorded on a data logger. Those data are concentrated at the server of the maintenance support system through the phone line. On the other hand, the area's weather-related data from the meteorological agency are sent to the system server through the private line.

Development of Forecast Information

Based on the collected data, the system develops prediction information on road surface temperature and condition. This is based on the model to predict road surface temperature, taking into account the effect of running vehicles and surrounding environment (4, 5), by joint research with an academic institution (see Figure 3 and Equation 1–3). During the winter of 2006–2007, a study was conducted to verify the accuracy of the model, and it showed that the accuracy of the prediction through the model improved to approximately 2°C.

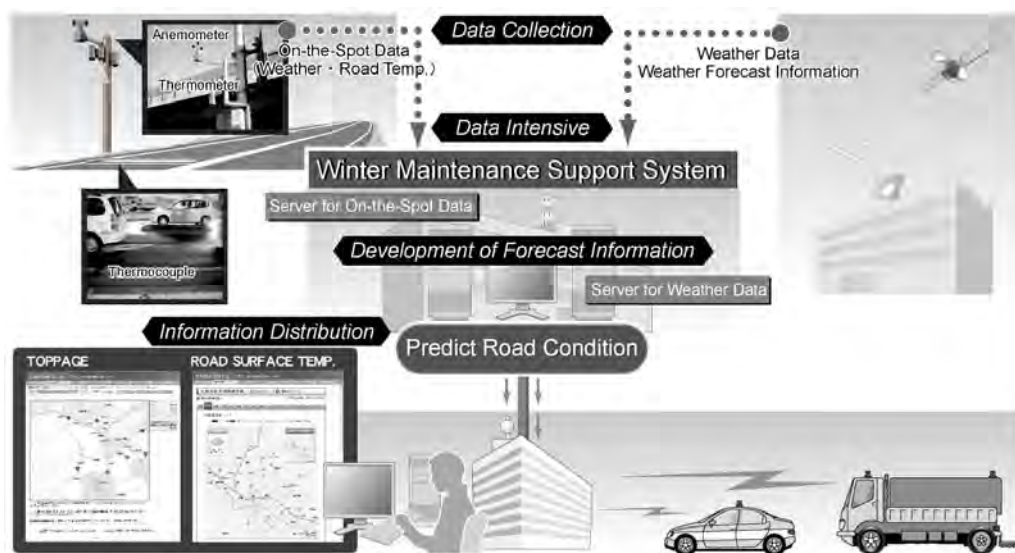

FIGURE 2 Conceptual diagram of winter maintenance support system.

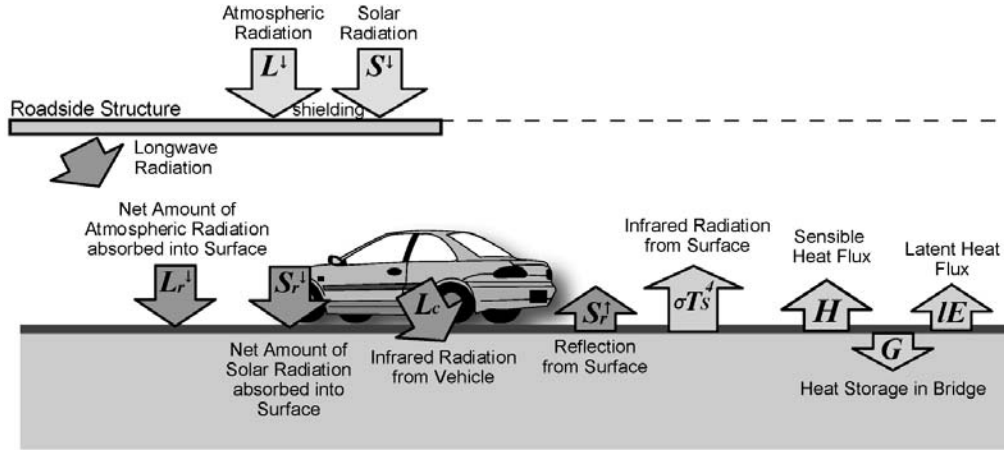

FIGURE 3 Conceptual diagram of road surface temperature prediction.

$$R^{\downarrow} = \sigma T_s^4 + H + IE + G \quad (1)$$

where

R^{\downarrow} = net thermal energy into the road surface,
 σ = Stefan–Boltzman constant,
 T_s = road surface temperature,
 H = sensible heat flux,
 IE = latent heat flux, and
 G = ground heat flux.

$$R^{\downarrow} = S_r^{\downarrow} - S_r^{\uparrow} + L_r^{\downarrow} + L_c \quad (2)$$

where

S_r^{\downarrow} = net solar radiation into the road surface,
 S_r^{\uparrow} = net radiation reflected from the road surface,
 L_r^{\downarrow} = net atmospheric radiation into the road surface, and
 L_c = net infrared radiation into the road surface from vehicular traffic.

$$L_r^{\downarrow} = (1 - \phi)L_r^{\downarrow} + \phi L_{strc}^{\downarrow} \quad (3)$$

where ϕ equals the rate of radiation shielding and L_{strc} equals the net outgoing longwave radiation from structures.

As shown in Figure 4 and Equations 4 to 6, the study developed the model to predict road surface condition based on water balance on road surface. The study defines road surface condition as five classifications of icy, compacted snow, slush, wet, and dry based on the storage amount of water, snow and ice. Besides, in this study, “road icing risk” is assumed by three classifications of “high risk” as icy roadway, “moderate risk” as compacted snow or slush, and

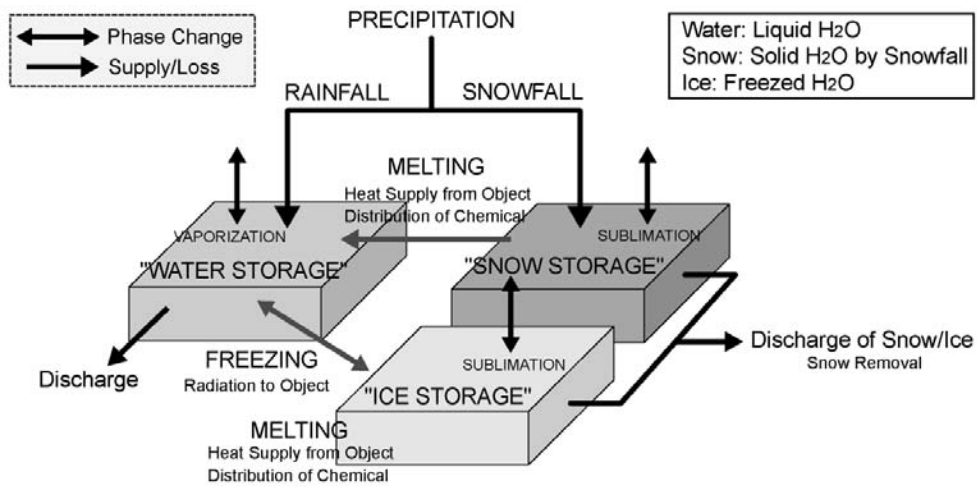

FIGURE 4 Conceptual diagram of road surface condition prediction.

“low risk” as wet or dry. The prediction accuracy during the 2006–2007 winter was approximately 60% in five classifications while about 70% in three.

$$\frac{dq_{\text{water}}}{dt} = \tau \cdot q_{\text{water}} + \frac{M}{L} - \frac{lE}{L_{\text{evap}}} + \text{Prec}_{\text{water}} \quad (4)$$

where

- q_{water} = accumulated water level,
- τ = drainage coefficient (0–1),
- M = melting (if positive value)/freezing (if negative value) heat transfer,
- L = latent heat,
- L_{evap} = enthalpy of vaporization, and
- $\text{Prec}_{\text{water}}$ = rainfall.

$$\frac{dq_{\text{snow}}}{dt} = -A \frac{M}{L} - B \frac{lE}{L_{\text{subl}}} - \Gamma \cdot rm \cdot \frac{q_{\text{snow}}}{q_{\text{snow}} + q_{\text{ice}}} + \text{Prec}_{\text{snow}} \quad (5)$$

where

- q_{snow} = accumulated level of snow,
- L_{subl} = latent heat of sublimation,
- rm = snow removal,
- $\text{Prec}_{\text{snow}}$ = snowfall, and

A, B, Γ : 0, 1 flags are

$$\begin{aligned}
 A &= \begin{cases} 1 & q_{\text{snow}} > 0 \text{ and } M > 0 \\ 0 & \end{cases} \\
 B &= \begin{cases} 1 & q_{\text{snow}} > 0 \\ 0 & \end{cases} \\
 \Gamma &= \begin{cases} 1 & rm > 0 \\ 0 & \end{cases} \\
 \frac{dq_{\text{ice}}}{dt} &= -(1-A)\frac{M}{L} - (1-B)\frac{IE}{L_{\text{subl}}} - \Gamma \cdot rm \cdot \frac{q_{\text{ice}}}{q_{\text{snow}} + q_{\text{ice}}}
 \end{aligned} \tag{6}$$

Process of System Development and Operation

Table 1 describes the process of system development and its operation.

Generally, there are two kinds of approach to develop the winter maintenance support system. One is a waterfall model, which develops the whole system at once with advancing a process in turn. The other is a spiral model, which performs design and mounting of a part of the system first and then repeats a design and mounting through the feedback from customers.

This study selected the latter model since a scheme and an interface desirable by the road authority were unknown in advance. Therefore, it was possible to improve a system, applying experimentally with repeated discussions about operation cycle, operation time, information service item, interface, and operability with the road authority and contractors. Otherwise, the system's continuous improvement has been performed from the early stage of the system development to realize effective operation (see Figure 5, Table 2).

TABLE 1 Process of System Development and Operation

Date	Action
2004~	Selected a case study route. Began to observe weather and road surface temperature. Developed the model to predict road surface temperature. Evaluated in model verification.
December 2005	Began to operate the system experimentally (provide text-based information: 1 point).
February 2006	Displayed the predicted result with the graph. Added the points to predicted road condition (1 point to 5 points).
December 2006	Started the experimental operation of the system with the same interface as the 2005–2006 version. Added the study route to predicted road condition.
February 2007	Integrated with the existing system used by road authority. Began to provide the route information for the case study route.



FIGURE 5 Discussion with road authority and contractor.

TABLE 2 Discussion Theme

1. Regarding State of Snow and Ice Control Operations
<ul style="list-style-type: none"> - Schedule and cycle of daily operation. - Goal on operational performance. - Point and section where should be noticed as icy roadway. - Important point and section for anti-icing treatment. - Amount of anti-icing materials and the proper use.
2. Item, Contents, and Interface
<ul style="list-style-type: none"> - Appropriate forecast time to provide information? - Necessary items for information service? - Suitable classifications for winter road conditions? - Appropriate display and description on top screen. - Amount of information displayed on one screen. - Size of screen showing predicted condition at specific point. - Permissible frequency of click. - How to display route prediction. - Request for the existing screen and information. - Request for long-term improvement.

SCHEME AND FUNCTIONAL FORMATION OF SYSTEM

Scheme of System

This system's scheme is shown in [Figure 6](#). The information to be provided to road authorities is roughly classified into two categories; mesh weather information and road icing prediction information. This is provided with accompanying general weather information. The outline of the main parts consisting of the system is introduced after the following subsection.

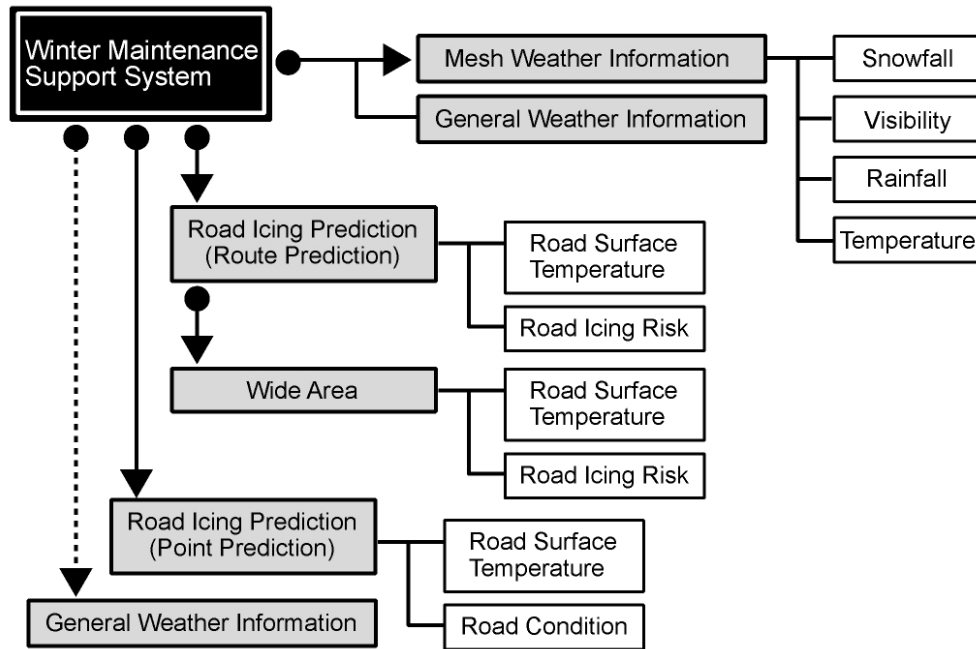

FIGURE 6 Scheme of winter maintenance support system.

Top Page and Mesh Weather Information Screen

Figure 7 shows the top page of the system. The road authorities had traditionally used the road management support system, which provided snowfall forecast information (6), except for this winter maintenance support system. Although the winter maintenance support system in this study was originally developed as an independent system, it integrated with the road authority's existing system according to the opinion from road authority and contractors. Integration is completed to put information together with utilizing the top page of the road management support system, which is high-name recognition as applied for many years. Consequently, the number of accesses has increased significantly.

The top page serves a double purpose for road authorities; one is the mesh forecast information including snowfall, visual range, rain, and temperature, and the other is the mesh weather information screen showing the past data. Only rainfall and temperature information are distributed from the Meteorological Agency, and all the other information develops in this system.

The size of each mesh is 1 km² in area, and the information to provide is classified into five steps on the basis of the value referred to when road authority works. Besides, the color pattern displaying information is made into about five colors based on the discussion in which it is difficult to distinguish the specific color when there are many categories.

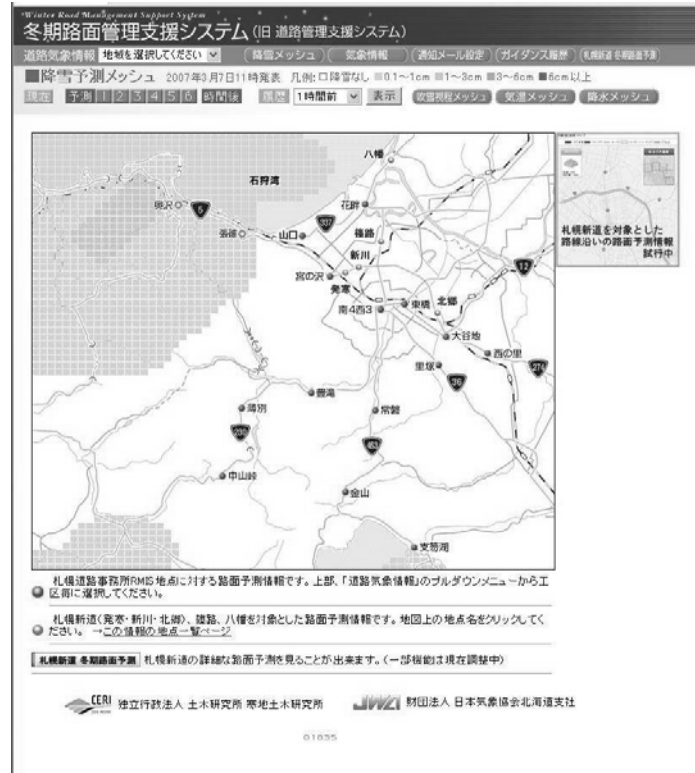

FIGURE 7 Top page and mesh weather information screen.

Road Icing Prediction Screen (Route Prediction)

One moves to the top screen of road icing prediction (route prediction) by clicking a map of the top page or the window beside the map. There are two kinds of information on road icing prediction. One is road surface temperature prediction, and the other is icing risk-related information (prediction information for road surface condition).

A road authority performs spot spraying limited to a crossing and a bridge with many slip accidents or the point being able to icing sectionally, rather than distribute anti-icing material to the entire route. Therefore, “information on route prediction” corresponds to such snow and ice control operations.

Road Surface Prediction Screen

As shown in Figure 8, the top screen of road icing prediction shows the panorama view of road surface temperature distribution of the targeted route. The road surface temperature is divided into five levels in addition to one with 2°C or more, which have almost no possibility of icing. Clicking the tab on a map, the system shows the road surface temperature distribution for 1- and 16-h forecasts. In urban areas, snow and ice control operations are usually conducted from midnight to early morning in order to provide as good winter roadway conditions as possible during morning commuter hours. Therefore, by setting to a 16-h forecast, it enables operational plans to be considered in the daytime.

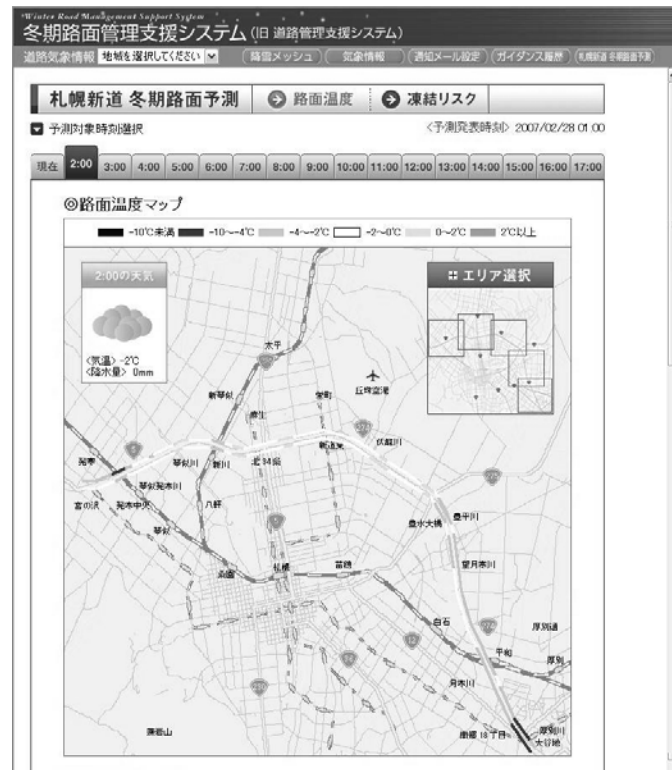

FIGURE 8 Road surface temperature prediction screen.

Moreover, road weather prediction (pictogram) and the weather forecast of temperature and precipitation are displayed on the small window at the upper left of the map. Then, clicking the small window at the upper right of the map, the system displays the area expansion map of the route with more detailed road surface temperature distribution.

Road Icing Risk Prediction Screen

When the risk of road icing button of the upper part of the screen is clicked, it moves to the top screen of road icing risk prediction, and the spot with road icing risk through the entire route is displayed (Figure 9). The system classifies the condition of snow-icy roadways into five levels: icy, compacted snow, slush, wet, and dry. The model to predict road surface condition corresponds to these five classifications.

At the present stage, risk of road icing is displayed at three levels: high risk (icing), moderate risk (compacted snow or slush), and low risk (wet or dry). This is due to the road authority's opinion that it would like to know whether a road surface would be icy more directly than through a detailed road surface classification. This page shows the same content as one of the road surface temperature prediction with the 1- and 16-h forecast. This page also shows the road weather prediction with pictogram at the upper left of the map, as well as arranging the small window of area selection at the upper right of the map.

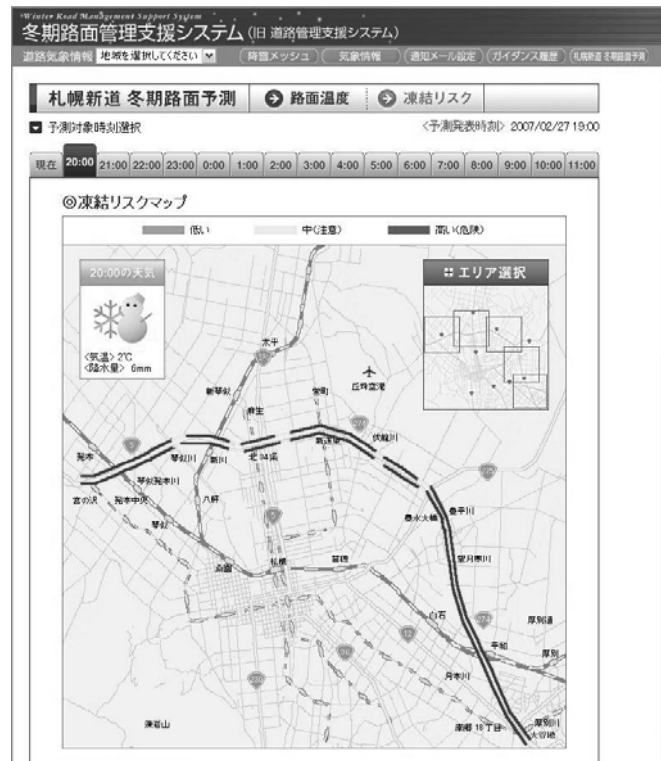

FIGURE 9 Road icing risk prediction screen.

Enlarged Screen View of Area

As shown in Figure 10, one moves to the enlarged screen view of each area from the area selection window in the upper right of the road icing risk prediction screen and road surface temperature prediction screen (see Figure 10). The enlarged screen view shows the location of a convenience store and gas station on the map, so it may become a guide for recognizing a point.

THE STATE OF THE SYSTEM

State of the Winter Maintenance Support System

The study had a workshop with the road authority and contractors in order to recognize the effective operation of the system. The main comments about the use of this system are described in the following. If there are some comments regarding the system's interface or operability, these are omitted in this section since those are overlapped with description in the previous sections.

State of Confirmation

- Check the information on the system for every hour when the weather is unstable, especially from 5 p.m. to 8 a.m.



FIGURE 10 Area expansion screen (left, road surface temperature; right, road icing risk).

- Check the information two to three times a day when the weather is stable.
- When considering operation plans at night, often confirm the information if evening temperature is less than +1°C.
- Do not use the system to fix the operational system at the time of storm.

Practical Use for Snow and Ice Control Operations

- Use as reference of anti-icing activity.
- Utilize as a factor that determines time to go on patrol.

Expectation and Direction of Future Improvement

- Change the predicted value of road surface condition after treatment by distributing anti-icing material.
- Since accountability is further required for operational activities from now on, use positively as reliable source.

Number of Accesses to the System

Figure 11 shows the trend of number of accesses to the winter maintenance support system. Although the number of accesses did not increase immediately after opening operations in December 2005, the number steadily increased after the end of January 2007. This might be due to increased cognitive level with the progress of time.

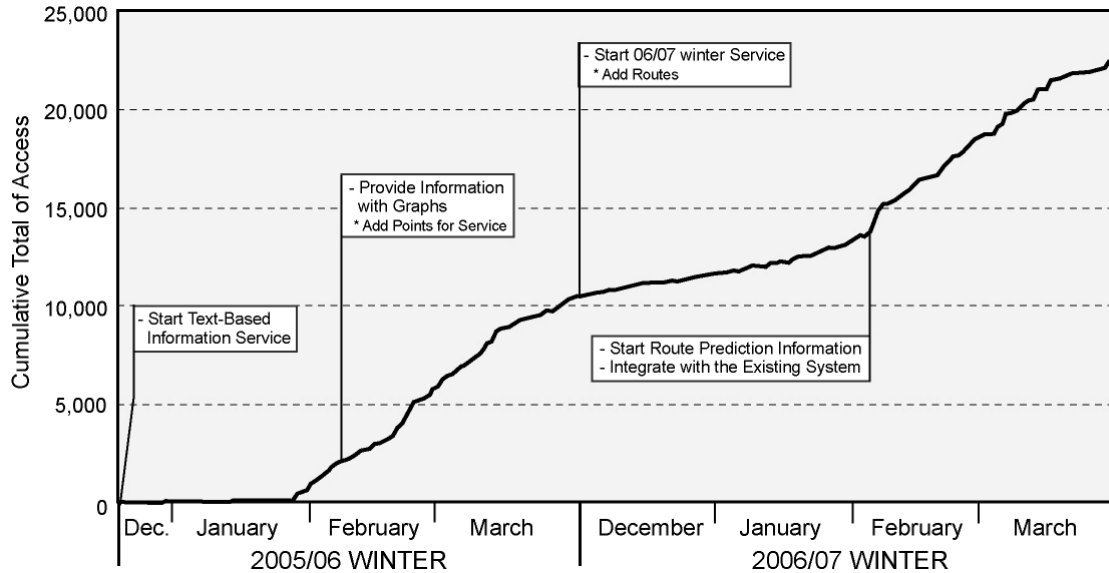

FIGURE 11 Trend of number of accesses to the system.

The number of accesses had hardly increased due to the effects of mild winter during the winter of 2005 at the beginning of its operation. However, the number came to be significantly increased with integration this new system with the existing one that had been used by road authorities, and with the start of the information service on road icing prediction for specific routes in February 2007. This might be due to the effect of providing information highly required by road authorities and to the effect of improvement of accessibility to information with the integrated system.

At the end of 2006, total accesses amounted to 22,503 although there was trouble with the access log temporarily. The system's visitors are the road administrator staff, mainly maintenance staff, and contractors who actually carry out snow and ice control activities. As for contractors, it is expected that the number of visitors is less than 50 since the staff in charge on the specific day mainly looks at the system. Therefore, the study finds that the system came to be used quite frequently with increased understanding.

CONCLUSIONS AND FUTURE THEME

This paper describes the background of developing the winter maintenance support program, the conceptual framework of this information system, and the state of the tentative operation. The system supports the road authority's decision making for snow and ice control operations. It is expected to contribute to effective and efficient winter road management programs by avoiding the excess spreading of anti-ice and antislip materials or the missing of areas that require treatment with improving the accuracy of forecast information. Therefore, we would like to enhance the system and make it more useful and reliable for road authorities by improving prediction accuracy, utilizing geographical information systems, and supplementing a function that presents proposed measures.

REFERENCES

1. Hokkaido Development Bureau. *Winter Road Surface Management Manual*. Draft. Hokkaido Development Bureau, Ministry of Land, Infrastructure and Transport. 1997.
2. Toivonen, K., and J. Kantonen. Finnish Road Administration's Web Road Weather Project. *Transportation Research Circular E-C063: 6th International Symposium on Snow Removal and Ice Control Technology*, Transportation Research Board of the National Academies, Washington, D.C., 2004, pp. 50–57.
3. Pisano, P. A., D. L. Huft, and A. D. Stern. Deployment of Maintenance Decision Support Systems for Winter Operations. *Transportation Research Circular E-C098: Maintenance Management 2006: Presentations from the 11th AASHTO–TRB Maintenance Management Conference*, Transportation Research Board of the National Academies, Washington, D.C., 2006, pp 79–90.
4. Takahashi, N., R. A. Tokunaga, M. Asano, and N. Ishikawa. Toward Strategic Snow and Ice Control on Roads: Developing Method for Surface-Icing Forecast by Applying Heat Balance Model. Presented at the 85th Annual Meeting of the Transportation Research Board, Washington, D.C., 2006.
5. Takahashi, N., M. Asano, and N. Ishikawa. Road Surface Temperature Prediction Model Taking into Account the Effects of Surrounding Environment. *Proc., Cold Region Technology Conference*, Vol.22, 2006, pp. 153–158.
6. Yamagiwa, Y., Y. Kajiya, and T. Uemura. Development of an Advanced Winter Road Management Support System for Greater Sapporo. *Transportation Research Circular E-C063: 6th International Symposium on Snow Removal and Ice Control Technology*, Transportation Research Board of the National Academies, Washington, D.C., 2004, pp. 18–30.

MAINTENANCE DECISION SUPPORT SYSTEMS

An Overview of Implementation and Deployment of the Pooled Fund Study Maintenance Decision Support System

ROBERT D. HART

JOHN J. MEWES

BENJAMIN W. HERSHEY

LEON F. OSBORNE, JR.

Meridian Environmental Technology, Inc.

DAVID L. HUFT

South Dakota Department of Transportation

Maintenance decision support systems (MDSS) are becoming an effective decision support tool for highway maintenance and operations' requirements. An MDSS considers past, present, and future weather conditions, pavement conditions, and maintenance actions, as well as agency policies, practices and resources information, in the decision process. The development of the pooled fund study (PFS) MDSS has been guided by 10 state transportation agencies, and as such is accommodating a wide range of operating practices and deployment options. The PFS MDSS has been developed as an open system to which external data sources can be directed and integrated into the decision process. The PFS MDSS incorporates observations from surface weather observing networks (including roadway weather information systems) and integrates them with other remotely sensed meteorological information such as that collected from weather radars and satellites. The combined effects of these weather conditions and agency maintenance actions that have already been performed are simulated by using a sophisticated model, creating an ongoing assessment of current and recent road conditions along agency-defined maintenance routes. Using this same model, the current road condition (with its computed concentration of a deicing agent) and the forecasted weather conditions become the basis for route-specific treatment recommendations. Each recommendation considers available local resources (such as materials, equipment, and personnel), institutional policies and practices, and the specified level of service for the designated route. This paper will describe the development of the PFS research program and the resulting software. It will highlight the objectives of the program and summarize the accomplishments of PFS MDSS in meeting the operational needs of winter maintenance operations. The paper will also discuss the range of deployment options available and illustrate how these options can be tailored to meet the specific needs of the wide range of agencies tasked with winter maintenance activities.

The roots of the pooled fund study maintenance decision support systems (PFS MDSS) extend well back into the implementation and expansion of roadway weather information systems (RWIS) networks that started in the 1970s and continued through the remainder of the 20th century. State agencies deploying systems quickly realized that the information resources associated with RWIS offered a more extensive understanding of the interactions that take place in the layer of snow, ice, water, and chemicals that they deal with during snow and ice control activities. In fact, the volume of information that RWIS produced and the complexity of the interactions that became evident from the measurements led RWIS owners to realize that a tool was necessary to help maintenance personnel utilize the wealth of data effectively. In response to

the interest expressed by state maintenance organizations for an expansion of the RWIS capabilities, FHWA initiated the surface transportation weather decision support requirement (STWDSR) research project in the late 1990s to determine the interest and need for a decision support system for maintenance activities. STWDSR evolved into the MDSS program late in 2000. Meetings, convened to assess and expand the understanding of stakeholder needs, brought together a large community of interested individuals representing state, federal, international, research, and private-sector organizations. The meetings and associated research led to the decision in mid-2001 to develop a proof of the MDSS concept designated as the Functional Prototype (FP). It was within the collegial environment of open dialog during the MDSS meetings in 2001 that a group of stakeholders discussing MDSS and the merits and limitations of the proposed MDSS FP formulated the concept of the PFS MDSS.

In 2002 that group formed a PFS to develop an alternative MDSS approach. The initial MDSS pooled fund study group comprised four states: Indiana, Minnesota, North Dakota, and South Dakota. South Dakota served as the lead state. Iowa joined the program shortly thereafter. The primary impetus for this program was to incorporate maintenance factors in a more dynamic nature into the development of a MDSS solution. The FP solution was designed to use the FHWA *Manual of Practice* guidelines published in 1996 as the decision logic for determining maintenance recommendations. These *Manual of Practice* guidelines represented best or normal practices for given winter scenarios and thus the recommended maintenance actions would tend to duplicate recommendations of existing practices. The PFS members felt that resource constraints inherent in winter operations were critical in making daily operational decisions and these were not included in the FP decision logic. Shortages of materials, one or more maintenance vehicles out of commission, or personnel scheduling often required major adjustments from the standard approaches and the FP approach was not designed to deal with these critical decision support factors. Further, the FP did not permit the user to investigate alternative treatment scenarios to determine if cost savings could accrue by responding to a winter situation in a different way than normal.

OBJECTIVES

Based upon their broader vision of MDSS the charter members of the PFS established four primary research objectives for the PFS MDSS project. They were

1. To assess the need, potential benefit, and receptivity in participating state transportation departments for state and regional MDSS.

The intent of the MDSS program was not to replace the human element in the decision process but rather to demonstrate the benefits that could be achieved by utilizing a computer-based decision system as a decision aid. Given this challenge, there was no absolute guarantee that all departments of transportation are prepared to embrace intelligent transportation system methods associated with an MDSS. Before proceeding with a major research initiative that would require both a significant fiscal and personnel commitment to develop, the participating states desired an assessment regarding the appropriateness of the MDSS within their operational environments. This assessment was done through an evaluation of existing maintenance methods, the operational needs, the receptivity to change, and the use and perception of

computer technology within operations. These factors were evaluated to identify the degree to which the proposed work will produce the desired outcomes and potential benefits.

2. To define functional and user requirements for an operational MDSS that can assess current road and weather conditions, forecast weather that will affect transportation routes, predict how road conditions will change in response to candidate maintenance treatments, suggest optimal maintenance strategies to maintenance personnel, and evaluate the effectiveness of maintenance treatments that are applied.

The objective of the proposed research was to construct the first operationally deployed MDSS. The research team had agreed that the MDSS must

- Assess the current road and weather conditions,
- Predict future road and weather conditions,
- Predict how the road will react to the forthcoming weather conditions and to candidate maintenance treatments,
- Suggest optimal maintenance strategies based on these scenarios and available resources, and
- Evaluate the effectiveness of the treatments applied relative to the results suggested by the MDSS in order to foster further improvement in the MDSS decision logic.

The intent was to define what the requirements were up front, indicating whether it was feasible to expect the necessary involvement from the agencies using MDSS and suggest a plan of action to see that the data and user inputs needed for the MDSS were available and could be acquired in an acceptable manner.

3. To build and evaluate an operational MDSS that will meet the defined functional requirements in the participating state transportation departments.

A pilot test was proposed in each of the participating states to provide insight into the effectiveness of the prototype's design and perform a proof-of-concept evaluation. Where possible the pilot tests were conducted along adjacent borders between states to demonstrate the worth of inter-jurisdictional use of the MDSS and define issues associated with the implementation of a system that spanned political borders. From the information learned from the pilot test, the contractor would implement refinements and enhancements that would then be tested during the second year of the program.

4. To improve the ability to forecast road conditions in response to changing weather and applied maintenance treatments.

The consensus view of the MDSS was that an effective MDSS would require capabilities that had not been integrated into a maintainer's decision support toolset. In fact, several important scientific factors had not been addressed adequately in research programs supporting the maintenance community. Most deal with the physics and chemistry of the mixture of snow, ice, weather, and chemicals present on highways, loss of material applied to the surface, uncertainty of time of application, makeup of the material being applied, and the time between maintenance applications during much of the winter. The approach to resolve the existing deficiencies was to delineate those areas where an inadequate understanding of weather to road condition relationship exists or those areas that have not been effectively integrated into operational support programs and then define steps to resolve the deficiencies.

ACCOMPLISHMENTS

The PFS project management team designed the MDSS program as a multiphase research and development program with a final goal of achieving a statewide deployment of an operational decision support system in each member state. The four phases and their primary programs were

Phase 1—foundation:

- Needs assessment within each state,
- Analysis of institutional receptivity to technology and MDSS,
- Evaluation of the FP, and
- MDSS architecture and system design.

Phase 2—prototype test:

- Construct demonstration applications,
- Conduct limited testing, and
- Refine design.

Phase 3—field validation:

- Winter field tests,
- Case study analyses, and
- System enhancement.

Phase 4—deployment

The time frame in which these four phases were accomplished is laid out in [Figure 1](#).

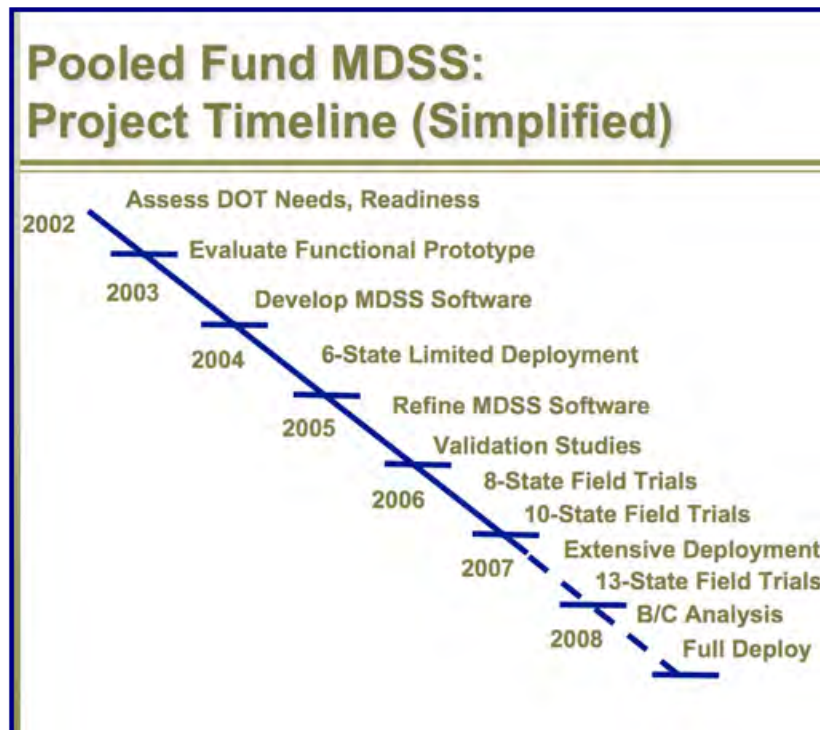

FIGURE 1 PFS MDSS project timeline.

The first objective of the project was to establish a baseline, so during the winter of 2002–2003 the research team surveyed and interviewed maintenance users within the PFS states regarding their experience, acceptance of technology and computers, and support needs they have that are unmet. User feedback revealed that DOT personnel were receptive to computer technology and technological support programs that would help guide their operational needs; however, a major portion of the users felt the computing resources they currently had were still somewhat limited. And while they were interested in technological advances they were also very comfortable in their current mode of operation and the techniques they had developed through years of experience. In the same time period, the design team evaluated the features of the FP. From the user survey, the information gleaned from evaluating the FP, and the direction established in the project's goals and objectives, the research team established the system architecture and delivered a prototype interface design. A significant feature of the design was its modularity, which would permit subsequent independent development of key components of the PFS MDSS software, thus allowing states to interchange modules within the MDSS software package. The design specified the data exchange protocols at the interface between the modules to assure interoperability.

Colorado joined the PFS at the beginning of Phase 2, expanding the study group to six. During 2003–2004 the research team programmed the graphical user interface, the geographic information system weather interface map, and the treatment recommendation module, which were to become core elements of the PFS MDSS and distinctive capabilities of the pooled fund solution. The first operational test of the software occurred late in the winter of 2004–2005 and was designated the limited deployment tactical integration test. It permitted the development team to test the acquisition of maintenance data from the field and evaluate how the system worked in short-term “tactical” maintenance scenarios.

The existing PFS MDSS evolved from the foundation laid during Phases 1 and 2. By October 2005 the lessons learned in the limited deployment test had been integrated into a formal release of the MDSS software. This software is currently in its third full winter of field testing. The number of states involved in the field tests expanded to eight in 2005–2006 with the addition of Kansas and Wyoming, to 10 in 2006–2007 with California and New Hampshire joining, and to 13 in the winter of 2007–2008 with the entry of Nebraska, New York, and Virginia. The technical panel, which is comprised of representatives from each state and the FHWA, has provided extensive guidance on the strengths and weaknesses of the software over the three years. This guidance coupled with input from a number of users who have been active users of the system has made the system a powerful support tool that has been continually refined to meet operational needs as users raise them.

The PFS MDSS is comprised of a server-side central processing component and a client-based graphical user interface. The server side software ingests weather observations and forecasts and maintenance information from the field on a continual basis. This information is processed for user-defined maintenance routes or route segments. Users may specify a wide array of information about each route including the physical characteristics of the pavement, the time it takes to drive the route in normal maintenance mode, the level of service required on this route, the types of treatment materials available for use and their cost, the hours of operation, and whether anti-icing is used. The server-side processor uses an energy–mass balance model called HiCAPS to simulate the actual conditions on the pavement surface. It builds a layer of snow, ice, or water as precipitation occurs and reduces this layer due to natural causes such as runoff, evaporation, or sublimation. It also handles processes such as plowing or the effects of traffic.

During winter situations the processing hub ingests reports of maintenance activity from the field and passes the treatment information to HiCAPS. The model simulates the effects of the reported maintenance action and using phase diagrams and latent heat exchange computes the updated condition of the dynamic layer (layer of snow, ice, water, and chemical on the road surface) and the temperature of the pavement. HiCAPS also simulates the mixing of applied chemicals and the physical movement of slush and water due to traffic using a vehicle-by-vehicle traffic simulation technique. The server-side software continually ingests current weather data and maintenance actions and updates the current simulated physical condition of the road surface. Using this initial road condition, pavement condition, and the weather forecast, HiCAPS then projects the pavement condition going forward. When the pavement condition exceeds the criterion established by the user-defined level of service requirement, the PFS MDSS software determines the least costly treatment option necessary to assure that the pavement conditions will not exceed the criterion before the maintenance truck completes its cycle and returns to the same point again.

Users view the results of the server-side processing via a client-side graphical user interface (GUI). The central server continually transfers weather data (current and forecasted), route conditions for all routes in the user's state, advisory messages, and user-supplied maintenance actions to the database on the user's computer or a computer maintained as a central application in a distributed processing system. In either way the GUI becomes a window on past, current, and future weather and highway conditions. The primary interface that came out of the PFS MDSS development effort is the map view (Figure 2). The map view permits users to control the display of weather- and route-specific maintenance information to meet specific user requirements. Users may select the information layers they want displayed and the parameters within each layer for current information or for conditions back as far as 24 h or the forecasted conditions out to 24 h. The time display control permits looping, incremental transition in user-selected time intervals, and direct selection of a specific time. All layers update as the time slider changes. Users can modify the geographic background to include markers such as geopolitical boundaries, highways, rivers and lakes, and locations of RWIS and National Weather Service (NWS) weather observation sites. The graphical user interface (GUI) permits the user to select a specific area and change the display to that area and place a legend on the display for reference. Users may save their preferential geographic areas and the layer content as custom selections to permit quick transfer to specific display formats. The display continually refreshes as new data reach the GUI database.

This display format resulted from the design specifications from the original set of objectives and several iterations of the actual presentation. A second significant component on the map view is the alert panel in the top left portion of the display. This alert panel was a feature of the original FP design that department of transportation (DOT) personnel found helpful because it provided a quick look at potential maintenance issues. From the original surveys in Phase 1 and ongoing interaction with users through the field tests, the alert panel was refined to better meet the operational requirements of the PFS members. Figure 3 illustrates the four components of the alert panel. It provides an indication of potential adverse weather conditions in four categories: weather, road conditions, blowing snow, and NWS watches, warnings, and advisories for each of the next 24 h. The first three alerts are route specific. By placing the mouse over the specific alert cell, the GUI will provide a text description of the alert criterion. The alert panel is tied to the user's area of concern. This area of concern may be the entire state, the current map view, or a specific user-defined route or area of interest.

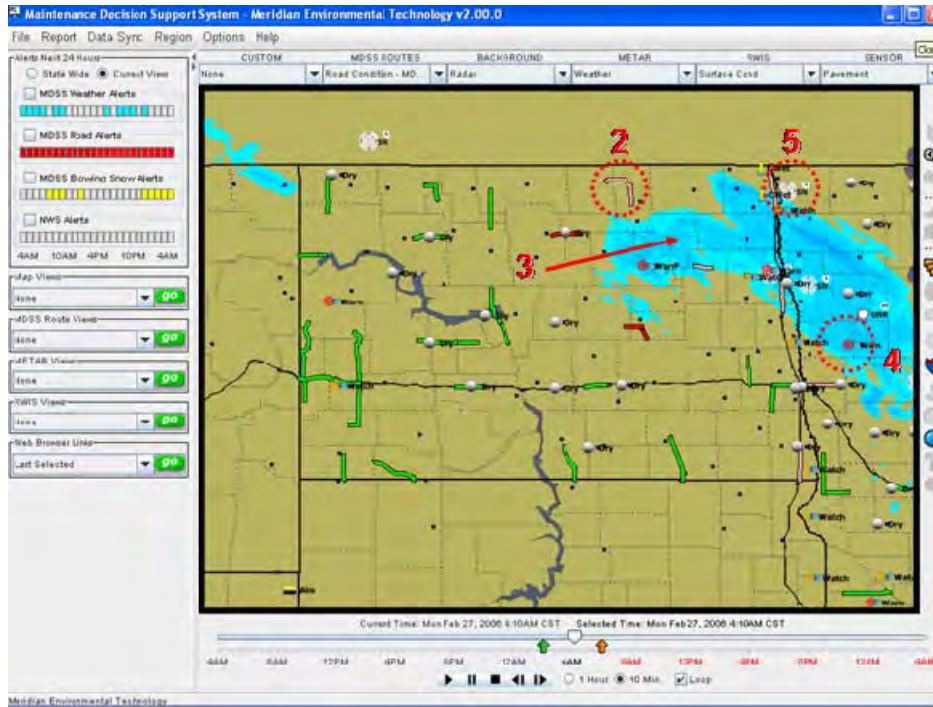

FIGURE 2 Map view containing a multilayered presentation of information including (1) geographic background, (2) MDSS route conditions, (3) weather condition background, (4) RWIS data, and (5) observed weather data.

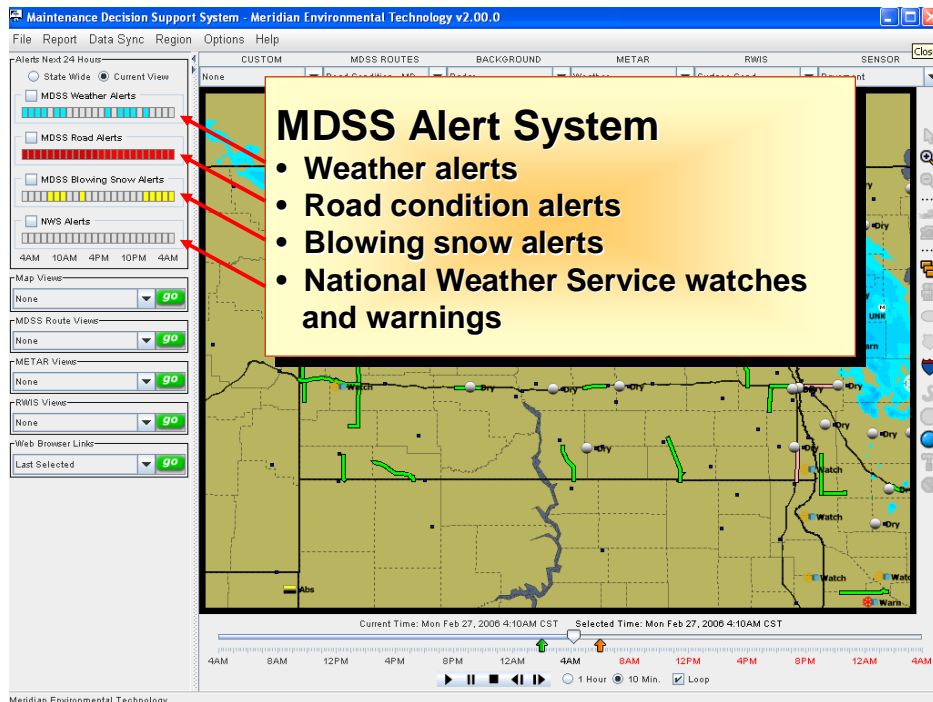

FIGURE 3 Display of the alert panel on the map view page.

The map view also is a selection tool for greater detail regarding any of the display parameters. By pointing to any of the criteria listed in the description under Figure 2 and left-clicking the mouse, users may display the detail associated with that icon. Drop-down windows contain the requested information for that specific site. Typically these drop-down displays contain another link that permits the user to switch from the map view to a presentation format that shows historical information or forecasted information associated with the selected map view parameter. Figure 4 illustrates two drop-down presentations overlaid over the map view: a camera image from a camera icon and route information for the route icon selected by the user.

From the drop-down route information display, users may select to switch to the route view (Figure 5) which presents the road conditions for the specific route segment about which the maintenance user has concerns. This display contains observed and forecasted weather for the specific route, the route conditions, the specific character of the dynamic layer (depth of snow, ice, and water), the percentage of ice in the dynamic layer, treatment actions that have been reported, treatment recommendations, and notes indicating why the decision logic made the recommendations it did. The information may be viewed in a graphic format as shown in Figure 5 or in a table format. The route view represents the culmination of the objective of the PFS MDSS project since it is the resource that the maintenance user views to check the system's treatment recommendations.

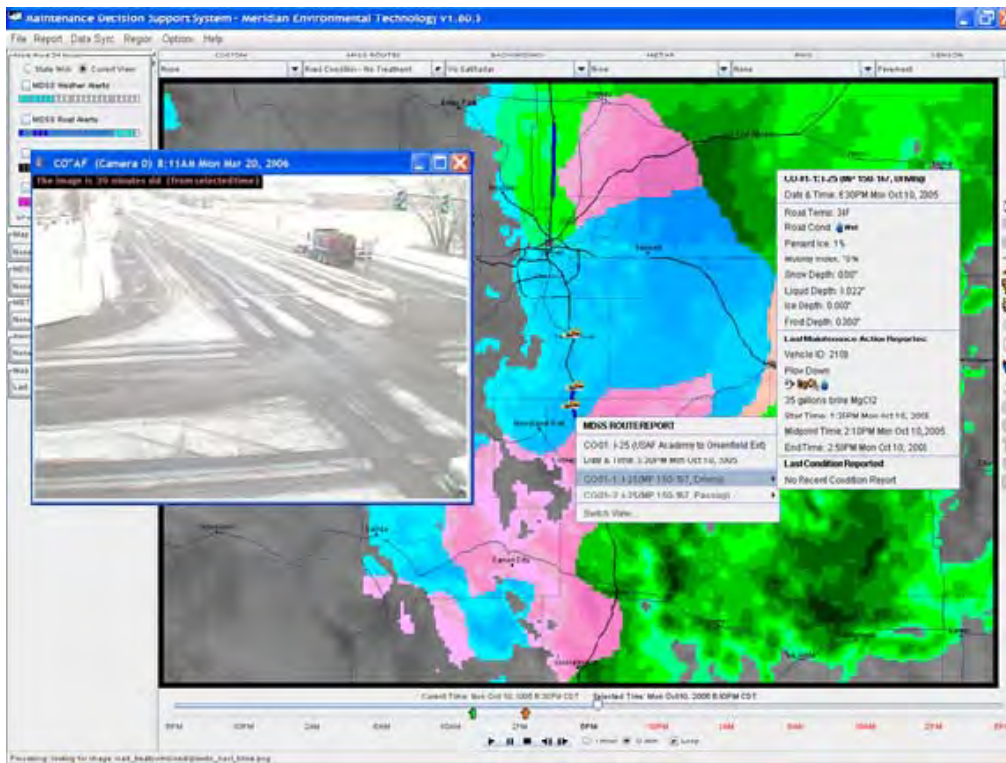

FIGURE 4 Map view with drop-down windows presenting camera imagery and route-specific information for a user-selected route segment.



FIGURE 5 MDSS route view showing past conditions and forecasted conditions.

From the inception of the study the integration of maintenance data has been an essential requirement of the program. In Phase 2 users entered the data using manual input techniques. Drivers rejected this approach after the first year. The evolving automated vehicle location (AVL) technology was integrated with mobile data collection (MDC) systems designed to store information from mobile controllers. MDC had become prevalent in the last decade as the automotive industry started integrating monitoring devices on vehicle electronics and the manufacturers of maintenance controllers enhanced the electronics within their controller systems to monitor and record maintenance activities and application rates. MDSS offered a need to log maintenance activities routinely as both a function of location and time. Several manufacturers moved to fill this requirement and created a combined AVL/MDC system. Some of the maintenance data needed by MDSS could be captured on the truck automatically; however, certain parameters had to be input by the drivers. In order to enter and transfer driver-observed conditions, the AVL/MDC program placed easy to use touch screen monitors in a number of the vehicles in the participating states. This capability was well received since it was so much easier than the manual entry tried previously. The original design of AVL/MDC had been one-way communications—driver to central data collection center. However, the monitors provided an excellent potential for the display of MDSS information back to drivers while they were in the field. This feature became a reality in the second year of field testing. Figure 6 shows the display from one of these monitors of information requested by the driver. The display for these small monitors has a simple format and the data set typically contains the current radar image centered on the vehicle's location, recent weather, and recommended treatment actions.



FIGURE 6 In-vehicle truck display of MDSS recommendations.

DEPLOYMENT OPTIONS

The ultimate goal of the PFS MDSS research project was the deployment of an operational MDSS that met the original expectations of the pooled fund participants. The PFS team has achieved a robust decision support system through active participation of the development team and the users. Much of the system was built upon a strong interaction between these two parties. Deploying outside of this environment will create some new challenges. The specific challenges fall into six categories:

- Technical considerations,
- Cost factors,
- Information technology requirements,
- Institutional issues,
- Intellectual property, and
- Training.

The technical considerations, cost factors, and information technology factors are all intertwined. The ongoing cost to operate MDSS is driven by two primary factors: number of users and number of routes. The number of users impacts communications costs and the number of routes impacts processing and user support costs. There are several technological solutions to minimize the costs but each state will need to evaluate its resources and determine the most effective method of sharing state-supported communications and data processing resources. The

institutional issues deal mostly with the fact that humans are adverse to change. If the PFS MDSS demonstrates the worth that the technical panel members and the development team see, then these barriers will diminish over time but acceptance may take several years. The PFS member states have a paid in full license to use the software and have intellectual property rights to the software developed under the PFS. There are some components that do represent pre-existing technology and do not fall under the Internet protocol umbrella. Training will be an essential component of MDSS as it is distributed throughout an agency. Whether the training comes from an outside vendor or is done by champions within the organization, it will be essential since new participants in the program will need guidance to learn and appreciate the many facets of the MDSS PFS user interface. Finally, the AVL/MDC program was not a direct component of the MDSS research effort. However, it has become an essential tool to acquire input on maintenance activities and subsequently has become important in the transfer of weather information and treatment recommendations to those decision makers who make their decisions from the cab of a winter maintenance vehicle.

REFERENCE

Ketcham, S. A., L. D. Minsk, R. R. Blackburn, and E. J. Fleege. Manual of Practice for an Effective Anti-icing Program: A Guide for Winter Maintenance Personnel. Publication FHWA-RD-95-202. FHWA, U. S. Department of Transportation, June 1996).

MAINTENANCE DECISION SUPPORT SYSTEMS

Maintenance Decision Support System Is Not Just for State Departments of Transportation

WILLIAM (PAT) KENNEDY
City and County of Denver Public Works

Maintenance decision support systems (MDSS) are becoming important tools in the winter weather response strategies of many state departments of transportation. Their value can be extended to local agencies as well. The City and County of Denver, Colorado, has incorporated MDSS with other technological aids to support our snow response and provide the citizens of Denver with a safer driving environment and increased level of service. We contract our MDSS service from the university component of the National Center for Atmospheric Research (NCAR), the University Corporation for Atmospheric Research (UCAR) in Boulder, Colorado. This MDSS has been established to provide weather prediction and treatment recommendations on statewide, regional, and local levels. The weather prediction module of the system utilizes numerous forecast elements and melds these together to form an accurate forecasting model. The system goes much further than just predicting the weather for the next 48 h. Existing atmospheric and roadway conditions are available from dozens of locations statewide. We have also provided the staff at UCAR with our typical response strategies and material usage, which they incorporate into their predictive models. The treatment module provides a recommended treatment strategy to keep roadways at an optimum condition during the course of an event. Included in the software is a treatment selector that allows city staff to different response strategies to see what effect they may have on roadway conditions prior to implementation. The city has not limited its use of technology aids in snow response to just MDSS. The city has invested in pavement sensors that provide surface and subsurface temperatures, moisture phase, and residual chemical concentrations. All these provide information important in the decision process of when and what deicer chemicals to deploy. These data will be integrated into the UCAR MDSS for the winter of 2007–2008. The city has also developed a geographic information system application to monitor the status of plowing operations for the 1,800 lane miles of designated snow routes within the city. At this time the data are only used internally, however, we anticipate at some point this data will be made available to the general public. Currently the snow route status is manually entered into the database that feeds the application but this will become automatic with the implementation of in-cab Global Positioning System–automatic vehicle location equipment. These technologies are exciting tools, but they do not serve the public if they cannot be used to positively affect the level of service we provide to the citizens. There are two ways we can see a direct benefit to the public: cost and safety. The ability to provide timely response, especially in the area of storm pretreatment, can significantly increase the safety of the public during inclement weather. Costs can escalate if crews are mobilized too early or material is placed when unnecessary. MDSS gives us access to critical information that aids in our decision making for storm response. Proper use of these innovative tools allows us to provide the citizens with a cost-effective and beneficial response to winter weather.

Snow removal along major transportation corridors is a time-consuming and expensive endeavor but it is vital to help provide a safe environment for the traveling public (Figure 1). Accurate forecasting of upcoming weather events is an important part of the response by any agency. Deploying forces for storms that do not materialize wastes scarce resources and, even worse, missing the start time of an event can lead to hazardous driving conditions. The effects on



FIGURE 1 Denver, Colorado, plowing operations.

a roadway network from early and late season storms are particularly difficult to predict and respond to appropriately.

A maintenance decision support system (MDSS) is a tool to assist agencies in their planning and response to winter weather. MDSS combines forecasting, existing and predicted pavement condition, and agency standard practices to produce recommended strategies for winter weather response.

For state departments of transportation, multiple responses are necessary to fit geographic or jurisdictional boundaries. For example, weather effects can be dramatically different over small distances in the mountains and plains of Colorado. These effects may not be as noticeable across Denver, but wind variations or the effect of upslope storms can cause different conditions across the city. We have found the power of MDSS to be a great benefit in the planning and implementation of winter weather response.

BACKGROUND

Denver is the 24th largest city in the United States (2000 census) with a population of 550,000 people. The city sits at the eastern base of the Rocky Mountains in north central Colorado. The location of the city leads to varying weather conditions that in turn can make weather prediction a challenge.

Denver receives an average of 60 in. (1.65 m) of snow annually spread out over 12 to 15 events. Snow can occur as early as September or as late as June. Storms greater than 12 in. (30 cm) occur infrequently. March and November are the snowiest months and sunny days with warm temperatures usually follow a winter weather event. All in all, winter weather in Denver is not as brutal as popularly believed around the nation.

Denver Public Works is responsible for maintaining about 1,900 centerline miles (3,075 km) of streets in the city (Figure 2). City forces clear snow from the arterial and collector network. A fleet of 68 plows is used to clear these streets, which total about 700 centerline miles or 1,800 lane miles (1,125 km, 2,900 km).

In 2004, Denver was invited to participate in the MDSS stakeholders and the *Clarus* Initiative. *Clarus* is a program managed by FHWA to collect, quality check, and provide access to weather data as they relate to transportation systems in the United States and Canada. MDSSs are a tactical use of this data to aid in agency response to winter weather. As a city, we saw the value in MDSS. The university component—University Corporation for Atmospheric Research (UCAR)—of the National Center for Atmospheric Research (NCAR) in Boulder, Colorado, was developing the federal prototype of a MDSS, and the city entered into a contractual relationship with UCAR prior to the 2006–2007 winter to use their system.

MAINTENANCE DECISION SUPPORT SYSTEM

Development of MDSS technology started around 2000. As of this writing, MDSS is used by about 15 different transportation agencies nationwide. A full examination of the details of MDSS is best left to the scientists, meteorologists, and engineers who created it, but a brief description of the system used by the City of Denver is included here.

The federal prototype developed by UCAR (Figures 3 and 4) has three basic modules: weather prediction (Figure 5), pavement condition and prediction, and treatment recommendations (Figure 6). The weather prediction module uses multiple data sources and predictive elements to form a weather prediction for a 48-h period that includes probability of moisture and the phase, accumulation, intensity, wind, temperature, and other important data sets for the road weather environment.

In the second module, MDSS uses the data in conjunction with existing weather-related pavement data to form a prediction of expected pavement conditions over the next 2 days. The

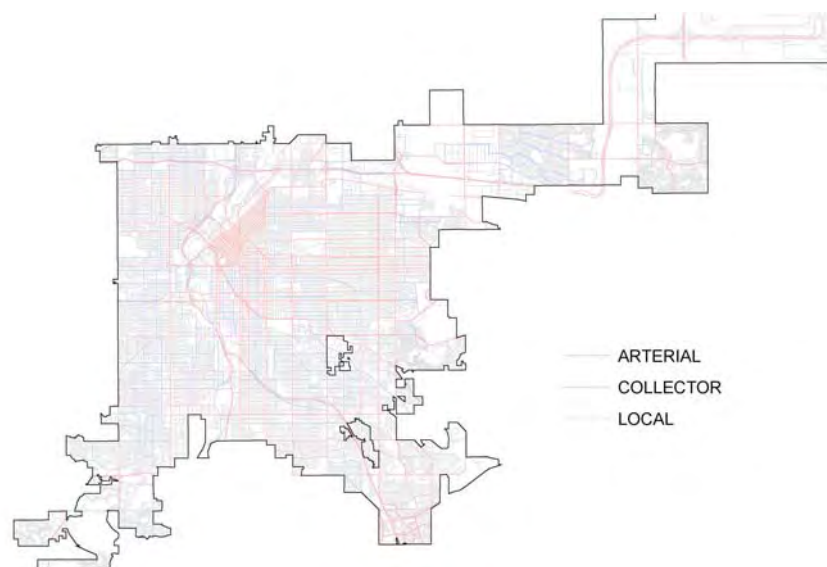

FIGURE 2 Denver street network.

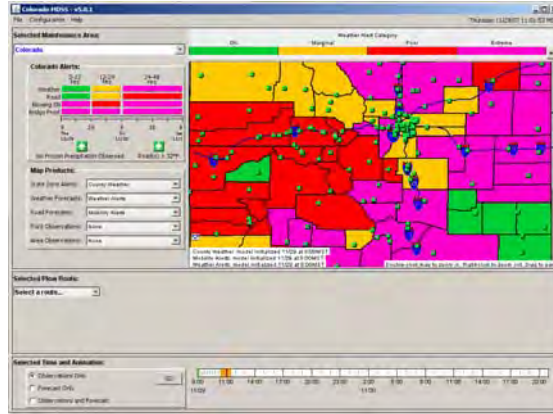

FIGURE 3 An MDSS opening page.



FIGURE 4 Another MDSS opening page.

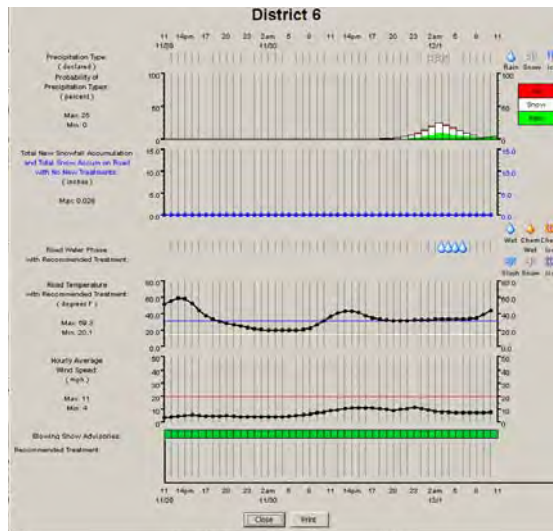

FIGURE 5 Weather and road predictions.

District 4
Treatment Scenario: Alternative 1

Select Material:

- Plow Only
- NaCl
- CaCl₂
- MgCl
- CaMg Acetate
- K Acetate
- Caliber
- Ice Slicer
- Ice Ban

Select Form: Dry

Select Amount: 200 lbs/lane-mile

Select Start Time: Thu Nov 29, 11:00

Treatments:

Thu Nov 29, 11:00 - treat with 200 lbs/lane-mile of dry NaCl

Add Treatment

Delete Treatment

OK Cancel

FIGURE 6 Treatment recommendations.

city has provided UCAR with basic construction data for the pavements that is used by MDSS to model latent heat and subsurface temperatures that will affect surface conditions. A roadway weather instrument system data, which provides existing condition data, allows for calibration and forward error correction of the predictive models.

Having a prediction of the weather and expected pavement conditions for a 48-h period is valuable in formulating a deployment plan for winter snow operations. MDSS takes this a step further in the third module by making recommendations for a treatment regimen throughout the course of a storm. The city has provided the MDSS staff with the types of materials used and the standard operational procedures for snow removal operations. MDSS takes this information and recommends treatments that should provide the greatest mobility and safety for the citizens. Within this module is the ability for city staff to enter other treatment programs that allow supervisors to check whether their own methods will obtain similar results.

We do not feel MDSS should supplant the decision making of the line supervisors and plow operators. They have years of experience and know the nuances of snow operations within their assigned districts. The recommendations provided by MDSS serve two functions. They provide our staff with verification that standard practices are appropriate, and give alternatives that could improve efficiencies. Second, our staff decisions serve as a cross check for MDSS recommended treatments. Since MDSS is relatively new technology working with dozens of variables, we are in a position to verify the veracity of MDSS and help improve the system for ourselves and future users.

SNOW OPERATIONS AND THE USE OF MDSS

Denver Snow Operations

As mentioned previously, Denver performs snow clearing operations on about 1,800 lane miles throughout the city. A standard ice control structure is used for operations. This structure

includes planning, operations, logistics, and administration sections. For most storms only the planning and operations sections are activated. Major events that require multiple days and other coordinated emergency operations may result in the activation of the other sections.

The city is divided into six districts and within the districts individual routes with three priority levels: A (highest), B (mostly minor arterials), and S (schools) (Figure 7). Each district is managed by a supervisor, who has 10 to 12 plows. Shifts are 12 h long, starting at noon and at midnight.

When long-range forecasts indicate a weather event is approaching the planning section begins monitoring weather forecasts from multiple services. When the storm is less than 48 h away, the planning staff launches the MDSS software to see what to expect with the onset of the event. A snow meeting is held with street maintenance managers between 12 and 24 h of the expected start of the event to make decisions on when and to what extent forces will be deployed. The MDSS forecasting module is an important part of these strategic decisions. The forecasting data we watch the closest will be the expected start time of the event, expected precipitation type, snow accumulation, and current and expected pavement temperatures. This information is used by management to decide when to shift crews from daily assignments to snow shifts and if anti-icing may be warranted.

Once an event has started, we can also use MDSS for tactical decisions. Forecasts are updated at 3-h intervals. The short-term forecasting data (precipitation, wind, temperature) can show when conditions may change and allow supervisors to marshal forces as needed to cover conditions or schedule breaks. For the winter of 2006–2007 Denver used MDSS mostly for strategic and tactical weather predictions. In general we did not use the treatment module. This was not due to inherent mistrust of the system, but because it is a new technology only the upper levels of management accessed the software. Following and modifying treatment recommendations are best accomplished at the field operations level. For the winter of 2007–2008, MDSS will be pushed to these field operations and with training, the field supervisors will begin to use this module. Coupled with this will be further refinement by the MDSS designers of the standard practice and material properties within the software. We anticipate full usage of MDSS capabilities prior to the 2008–2009 winter.

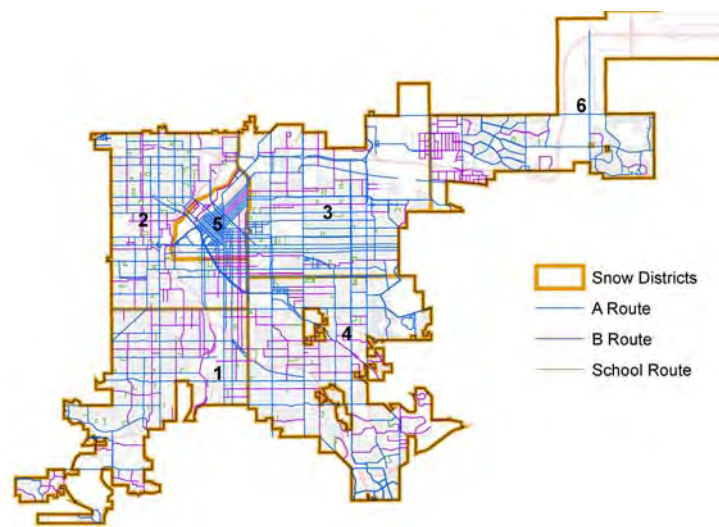

FIGURE 7 Snow routes.

OTHER TECHNOLOGIES

Denver has invested in other technologies that tie directly and indirectly to MDSS and winter snow operations. One of the direct links is the use of pavement sensors to augment and validate the predictions of pavement conditions made by MDSS. MDSS uses the typical pavement structure to predict surface and subsurface temperature profiles and how these will affect and be affected by snow or ice accumulations. The city has installed sensors (Figure 8) in four intersections that provide surface and subsurface temperature (Figure 9), phase of surface moisture and from the conductivity of the moisture, the concentration of chemical deicers on the roadway surface. MDSS can use these data and data from other sources in the models to predict the changes that will occur to pavements during the course of an event and validate the current model. Forward error corrections are made based on the measured current conditions.



FIGURE 8 Sensor installation.

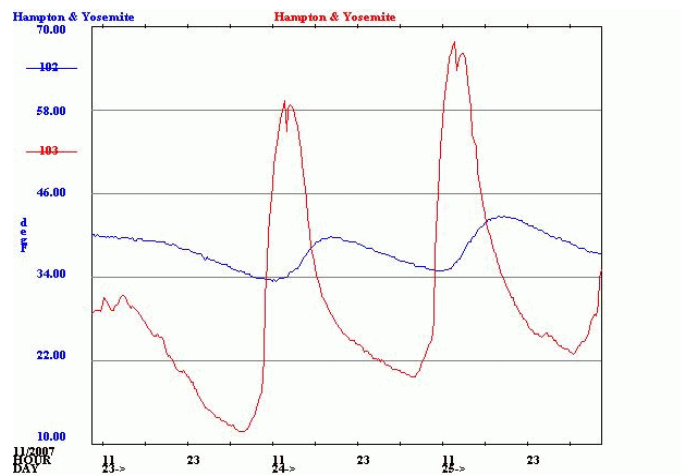

FIGURE 9 Pavement temperature graph.

A graphical interface system (GIS) in place is used to map snow route information and sensor data and has been provided to the UCAR staff to incorporate into the MDSS displays. A layer that shows the status of plow operations (Figure 10) can be combined with expected short-term weather effects as a tactical tool to assist supervisors in the best use of their resources.

During major events, the City Traffic Management Center (TMC) becomes the headquarters for snow operations. MDSS displays, sensor data, and traffic camera feeds can all be integrated to have multiple data sets available for analysis by all of the management at one time. Coordinated response efforts are easier to organize in this environment.

Automatic vehicle location (AVL) is in the future for street maintenance plowing operations. Data that are available from AVL include ambient and pavement temperature status of equipment, application rates, and other information that can be incorporated into the MDSS models. Complex inclusion of data streams from dozens of plows is probably a couple years off yet.

EFFECTIVENESS

Budgetary savings is only one way to measure the value of an MDSS. Accurate predictions of the start of an event help to ensure staff are not deployed too soon and unnecessarily incur wage costs. For Denver, the cost of a 12-h overtime shift on a weekend is \$30,000. A weekday extension of a shift 4 h is nearly \$10,000. Saving a few shifts of unnecessary deployments can make a significant budgetary savings. Material usage is another way to improve the budget. MDSS will recommend timing and the amount of material needed to provide optimal improvement in road conditions. Following those when the system recommends less than maximum distribution levels will result in material savings. For those who are familiar with

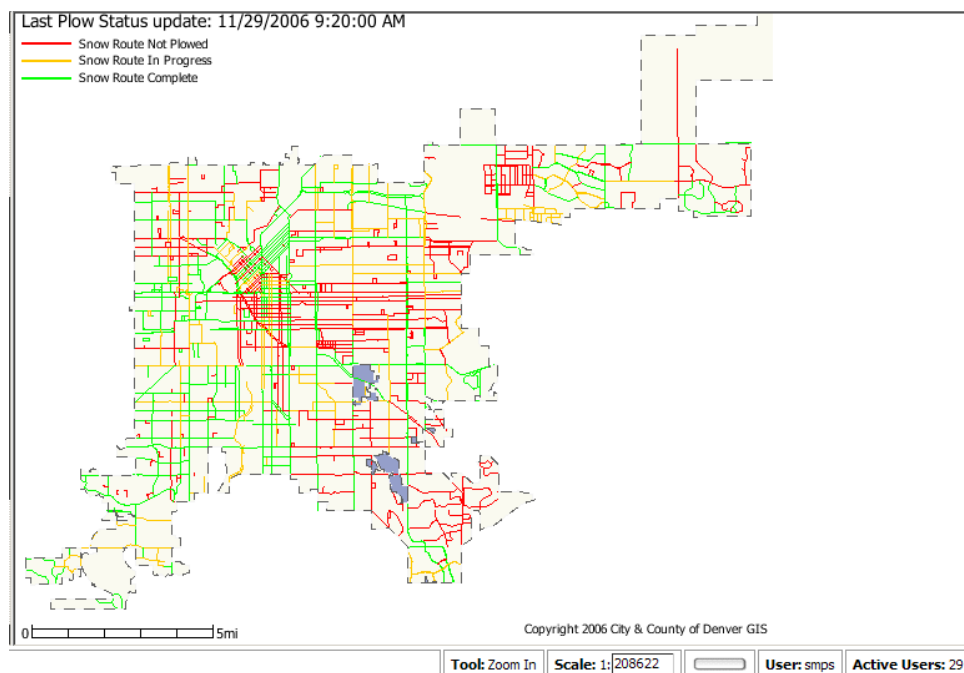

FIGURE 10 GIS plow status application.

field snow operations, many crews and drivers feel that if a little is good, a lot is better; changing that institutional behavior is a challenge. Performing a test and showing crews that the system can be trusted can yield material savings. Accurate predictions of the moisture phase of a storm can also be used to determine if a response is actually needed and what that response should be.

While it may be more difficult to measure, the improved service delivery is nonetheless a more important metric. The goal of any snow response effort is improved mobility and safety. If MDSS can be used to increase the efficiency and effectiveness of operations the natural result will be safer and easier driving conditions. In 2006, Denver experienced conditions in the final days before Christmas where travel around the city was nearly brought to a standstill. Business suffered significant losses due to the inability of the public to travel about. This storm was severe enough that accurate prediction and response recommendations had no effect on the impact felt by the citizens, but it does illustrate the fact that timely and proper response can have a positive impact on the short-term economy of the area.

To help in measuring the direct and indirect benefits of MDSS, Denver is partnering with FHWA to complete a cost–benefit analysis of the federal prototype MDSS Denver uses. This study will take two winter seasons to complete, the first to identify the metrics and the second to actually perform the analysis. Results of this study should be available in 2009.

FUTURE GROWTH OF MDSS

Denver began using MDSS in the winter of 2006–2007, but to be honest, that winter the full effectiveness was impossible to determine. Denver was hit by back-to-back blizzards 6 days apart during the holiday period, and Denver went into emergency response mode for over 2 months during which less intense storms hit at roughly 1-week intervals. Material stockpiles dwindled to nothing within the first 2 weeks so MDSS recommendations were then of little value. During that winter Denver staff used MDSS for weather prediction and little else. For the winter of 2007–2008 we have pushed MDSS down to field superintendent and supervisor levels, providing the middle management and field officers with another tool in their emergency snow response. This increased use is integral to the concurrent cost–benefit study. Over time we will continue to push MDSS information down to driver level, especially when AVL is implemented so tactical recommendations and weather information can be readily accessed by plow operators.

The designers of MDSS have also begun looking at expanding the capabilities of their system to include summer operations. This enhanced system can be used to increase efficiencies of summer operations by improving the predictions of weather impacts to those operations. For example high winds can adversely affect weed control, cool weather or rain can affect many different operations. Accurate predictions of timing and intensity can be used to schedule work crews with better effectiveness.

CONCLUSIONS

As of late 2007, fewer than 20 agencies nationwide were using an MDSS system in some manner, and Denver was one of only a handful of municipal or local agency users. In the short time it has been in place and with benefits measured more with anecdotes than hard data, it is still apparent that the system has been a valuable addition to the tools that are used in emergency

snow response. Our confidence in the predictive modules grows with every storm. An anecdotal illustration of this occurred on November 27, 2007. Local weather forecasters predicted nothing more than dropping temperatures and high winds for November 28 in Denver while snow was predicted for the central mountains. During the evening of November 27, MDSS predicted 1 to 2 in. of snow for rush hour the next morning. Snow began at 5:00 a.m. and lasted a little over 2 h and the final total was 1.6 in. Predictions like that will keep Denver as a client of UCAR and user of MDSS.

ACKNOWLEDGMENTS

The author acknowledges the following individuals for their expertise and vision in the development and implementation of MDSS by the City of Denver: William Mahoney, Kevin Petty, and the staff of the National Center for Atmospheric Research in Boulder, Colorado; Paul Pisano, project manager, MDSS Stakeholders Project and *Clarus Initiative* from the Federal Highway Administration; and Guillermo (Bill) Vidal, manager, and Dan Roberts, deputy director, Denver Public Works.

Snowplow Operations and Equipment

SNOWPLOW OPERATIONS AND EQUIPMENT

The High-Speed–Environmental Snowplow**PONTUS GRUHS***Swedish Road Administration*

A new kind of snowplow has been constructed. The snowplow has several advantages compared with a conventional plow: it can go much faster, it is more silent, and it is cheaper to use because the need of spreading chemicals is reduced. And all these advantages accrue without less quality than with a conventional plow. The secret is the invention of new cutting edges and new wheels. The new plow is also lighter than a normal plow. We call the new kind of snowplow “the environmental plow” or “the high-speed plow.” A couple of years ago the inventor Gösta Källqvist came up with an idea. If it were possible to calculate the forces that a snowplow is exposed to during normal use, it would be possible to construct cutting edges that would be strong and flexible enough to plow in much higher speeds than normally. Recently finite element analysis has made this possible. Tests of the new cutting edges have been carried out in a laboratory and after these tests one plow has been constructed with the new cutting edges. The new plow has not yet been tested objectively and scientifically on the road, but during the winter of 2007–2008 the new snowplow will be evaluated in a number of different tests.

Before the 1970s the cutting edges on the snowplows were not flexible. The cutting edges were mounted with an offensive cutting angle directly on the snowplow. The trucks that were used with the snowplows were small and could not go very fast. Later in the 1970s chemicals were introduced for winter maintenance, and heavier trucks were used. Furthermore, spring-strained snowplows with vertical cutting edges were introduced. The above described equipment is still used; however, the possibility of good results with this kind of plow is greatly reduced in speeds exceeding 35 km/h (≈ 22 mph). The reason for the limited efficiency at higher speeds is that when increasing the speed, the cutting edges must be lifted higher from the road; otherwise they risk breaking. There have not been many improvements or inventions in the area of snowplows since the 1970s.

The need for a snowplow that can go faster than conventional plows is obvious for both economical and traffic (accessibility) reasons. It would be possible to increase the speed of plows if the problem with the inflexible cutting edges were solved. But so far the knowledge of the forces and the force dynamics of plowing have been limited. After some work with finite element (FE) analysis, it is now possible to calculate the forces on the plow and therefore possible to construct a snowplow that is more durable. This knowledge has been used to construct a plow that has been subject to only a few tests and only during one winter. The new plow has flexible cutting edges (see [Figure 1](#)), which enable it to go at higher speeds than an ordinary snowplow. It is also lighter than an ordinary snowplow.

It is called the “environmental plow” or “the high-speed plow” (see [Figure 2](#)).

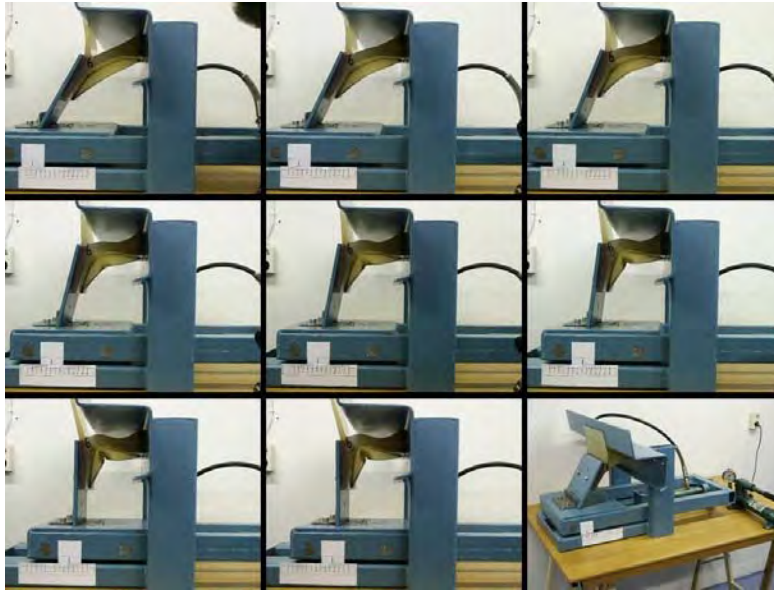

FIGURE 1 Flexible cutting edges.



FIGURE 2 The new snowplow with the new kind of wheels.

The new snowplow is able to go about 70 km/h (\approx 43 mph) and still remove the snow from the road in an effective way.

The test results are so far very promising, but there is still need for further testing. The tests will continue during the winters of 2007–2008 and 2008–2009, respectively.

TESTS DURING 2007–2008

During the winter of 2007–2008 several snowplows will be tested in four different places in Sweden. The tests are divided into four parts. Each part consists of a protocol to be filled in: first a protocol for the driver to fill in before using the plow; the second for the driver to fill in after action; the third is for the project manager to fill in; the last protocol is used for a before-and-after study. The two first parts are more subjective than the two last parts.

Part 1 (for the Driver Before Action)

- Note the date.
- Note the temperature.
- Note how long the vehicle has been running since it was last in use.

Part 2 (for the Driver After Plowing)

Type of Plowing

- Grit
- Snow
- Wet snow

Environment for the Driver–Noise

- Low
- Medium
- High

Environment for the Driver—Snow Smoke

- Low
- Medium
- High

Method

- Plowing
- Plowing + chemicals
- Only chemicals

Result After Plowing

- Low
- Medium
- High

Ability to Throw Snow

- Low
- Medium
- High

Ability to Cut the Snow–Ice

- Low
- Medium
- High

Part 3 (for the Project Manager)

- Maintenance cost per snowplow and winter
- Type of wheel (rubber, polyurethane rubber, more)
- Determination of whether steels have been changed and which type of steel is being used
- Measurement of the steels, how much has been torn down
- Comparison of the noise from the conventional plow and the environmental plow
- Measurement of how long it takes to change spare parts and how often
- Comparison of the state of the traffic signs, before and after the winter

Part 4 (Measure the Road Condition)

Before the tests, two similar test locations will be identified. The test locations will be as similar to each other as possible for temperature and snow–rain, traffic flow, profile, and maintenance class. A before-and-after study will be made.

The tests are expected to show

- Fuel consumption,
- Chemical consumption,
- Speed when plowing,
- Length of time to change spare parts,
- Frequency of necessity to adjust the plow,
- The noise from the snowplow,
- The noise in the truck (for the driver), and
- Any problems with traffic signs (if signs are too weak for the forces when plowing the snow).

Test locations and type of plows follow:

- Luleå. Tests with the environmental plow will be carried out on a 50-km-long stretch. A conventional snowplow will be used on the same road but in the other direction. The new plow is 4.60 m wide. On another road in Luleå, an environmental snowplow will be used with a side plow with modified cutting edges as seen in Figures 3 and 4. This will be compared to a conventional plow with a conventional side plow.

- Örnsköldsvik. A conventional snowplow will be tested on the same type of road as the environmental plow. On this road, which is smaller, sand with some salt is used instead of chemicals.

- Nyköping. One new plow 4.60 m wide and one new plow 3.60 m wide with a side plow with modified cutting edges will be tested.

- Gävle. One new plow 4.60 m wide and one new plow 3.60 m wide with a side plow with modified cutting edges will be tested.

In addition to this a “super” plow (a very wide plow mainly for use in “2+1” roads; the 2+1 roads are one lane and two lane alternated; when there are two lanes in one direction, there is one lane in the other direction) with modified cutting edges will probably be used in Luleå.

The snowplows that will be tested are both conventional snowplows but with modified cutting edges and brand new plows:

- 4.60-m snowplows,
- 3.60-m snowplows,
- Conventional side plows,
- The “super” plow, and
- Conventional snowplows, modified with flexible cutting edges.



FIGURE 3 Snowplow with modified cutting edges.



FIGURE 4 The wheel on the side plow will be replaced with a wheel made out of polyurethane.

BENEFITS

The environmental plow has both environmental and economical potential:

- The need to spread chemicals during the winter is reduced because the plow is more efficient. Some roads in bad condition have an uneven surfacing. Since the new plow is flexible, it will have an improved effect on such roads.
- The plow is more silent than conventional plows [because of less weight—about 300 kg less (\approx 660 lb)].
- Traffic safety will be increased since the plow is able to go in 70 km/h (\approx 43 mph) compared to about 25 to 28 km/h (\approx 15 to 18 mph), which is normal today.
- It is possible to cross bridges at a higher speed, because of the flexible cutting edge.
- The need for repainting road marks will be reduced since the forces are much less.

The secret is that the cutting edges are flexible (see [Figure 1](#)). The cutting edges are made out of polyurethane rubber with steel bars to reinforce the construction. This makes it possible to plow at much higher speeds than with a conventional plow. Furthermore, wheels in the same material as the cutting edges make it possible to plow at high speed.

With the new plow, it is possible to plow with a positive plowing angle, 55 degrees, which makes it more effective. Ordinary snowplows have an angle of 90 degrees (see [Figures 5](#) and [6](#)).

PROBLEMS

Since the speed will increase a lot compared to ordinary plowing, there is a risk for problems with traffic signs and fences. This has not yet been evaluated but it is a parameter that will be analyzed. One solution as seen in [Figure 7](#) is a kind of snow protection that will protect the fences and traffic signs by throwing the snow lower than normal.



FIGURE 5 New cutting edge, 90-degree angle.

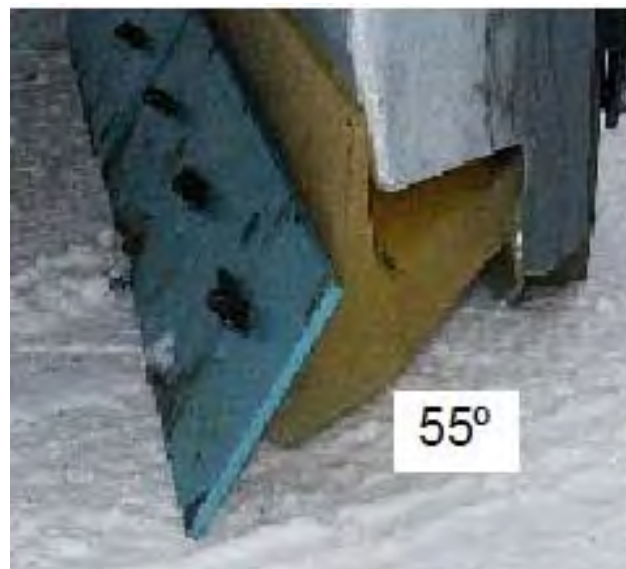

FIGURE 6 New cutting edge, 55-degree angle.

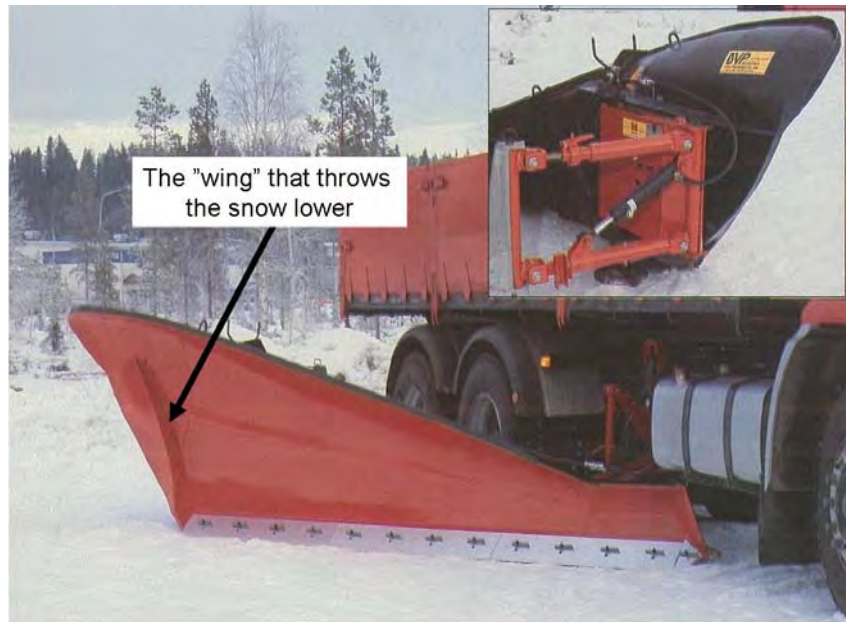

FIGURE 7 The plow with snow protection.

SNOWPLOW OPERATIONS AND EQUIPMENT

Plowing Wider and Faster on 21st-Century Highways by Using 14-ft Front Plows and Trailer Plows Effectively

ROBERT GLENN LANNERT

Missouri Department of Transportation

The Missouri Department of Transportation (MoDOT) has embarked on solving the challenges of clearing more lanes and shoulders, with the same number or fewer trucks and operators. The challenges were to plow wider and faster in an attempt to increase services without adding personnel. Using wider front plows to clear one 12-ft lane in one pass has proven to reduce the number of passes needed, saved fuel, and reduced labor. Using trailer plows (now known as TowPLows) has allowed one snowplow truck and one operator to clear over 24-ft wide at high speeds, providing a level of performance never before seen in the industry. Previous trucks with wing plows generally cleared a path of 16 ft or less at speeds less than 30 mph.

Highway agencies continue to build more lanes and paved shoulders to meet 21st-century needs. They built roads; the traffic came and has kept coming. Because continuing to build additional lanes is not an option in some areas, incident management strategy has changed its focus. Agencies must ensure that lanes remain in service, even during snow storms.

Today's Interstates continue to be stressed with more traffic and a greater need to remain in service. Snowstorms and snow removal operations are among the greatest threats to our highway systems and the movement of just-in-time commerce. Two-lane Interstates are being expanded to multiple lanes to meet today's needs, while snow removal operations continue to be dependent on 20th-century plowing equipment and methods.

Plowing of shoulders has become common to provide safety for multiple driving lanes. Many Interstates now have three lanes or more and center barrier walls, with wide left and right shoulders. These designs require one-pass snow removal to the right on multiple lanes, requiring eight or more snowplow trucks to perform the task and assure a windrow is never left in a lane.

In order to maintain the design capacity of a system, agencies have to maintain the intended design speeds. Therefore, plowing at 35 mph will not meet tomorrow's needs for high speed, high capacity roads. Most agencies continue to use 10- to 12-ft front plows. The largest truck and right wing plow combination can only clear up to 16 ft. Operators have difficulty using wing plows at high speeds. Adding more wing plows and more trucks with more operators became the solution for some agencies. The Missouri Department of Transportation (MoDOT) sought a different approach and new concepts.

ONE-PASS CLEARING BY USING 14-ft FRONT PLOWS

MoDOT has implemented the concept of using 14-ft front snowplows to achieve one-pass clearing in each lane on Interstates and other routes. More than 400 of the 1,800 trucks are equipped with these wider plows.

Wing plows were used in previous attempts to plow wider paths. These included front, mid-, and rear-mounted wing plows. Wing plows provided wider clearing paths, but also created several problems.

Ten- to 12-ft wings are very heavy; this causes most trucks to lean and often overload one tire or axle. The heavy hardware remained on the trucks which increased the average weight of the truck by several hundred pounds, affecting fuel economy and handling of the trucks in routine work.

The redesign of front plows created a reversible 14-ft plow, which could plow 11.5 ft at 35 degrees and 12.5 ft when operated at 27 degrees. The use of the 35-degree angle allowed for better snow flow, required less horsepower, provided better fuel economy, and increased production.

Returning the plow to a 25-degree angle allowed an operator to clear 12-ft lanes in one pass and cast the windrow beyond the edge line. Casting the windrow beyond the edge line is the most important asset of this concept. Most agencies use 10-, 11-, and 12-ft plows, which clear only 8 to 10 ft. These sizes require an operator to make a second pass to clear the driving lane. Eliminating a second pass can provide major savings.

Many agencies adopted the practice of using small (junior) wing plows to assure they cleared the entire lane in one pass. This equipment works well until one encounters higher speeds where trucks must plow faster than 40 mph to prevent rear end collisions. Wing plows tend to bounce or porpoise when used at speeds over 30 mph, and therefore are too slow for some applications.

The implementation of 14-ft plows provides a specific advantage when plowing Interstate and other divided highways. The previous practice of using smaller plows left the windrow of snow inside or on the edge line. Fast-moving, large trucks would then suck this windrow of snow back in behind them before the snowplow truck could return to make the second pass. One pass clearing disposes the windrow just outside of the edge line and reduces or eliminates this issue of trucks sucking the snow back across the pavement. Hence, the operator can proceed to the passing lane and clear it in one pass. This concept has proven to eliminate the need for additional passes, both on the Interstate and on collector routes.

GANG PLOWING OF MULTILANE HIGHWAYS AND SHOULDERS

Multiple lane highways of three lanes or more require gang plowing techniques to assure the windrow of snow is never left on the pavement. Some agencies do not allow the operators to cast snow to the left, against center median barriers. This practice helps to prevent snow ramps and situations where vehicles can catapult over the barrier. Therefore, agencies use four to 10 trucks in a line, called gang or echelon plowing, to plow all snow to the right. Additional trucks often follow to clear the windrows from blocking the exit and entry ramps. Gang plowing can consume the majority of available trucks. This practice creates two problems.

Gathering trucks into gangs often removed trucks from other assigned routes. The question became, “If we are plowing in gangs, where are we no longer plowing?” Gathering trucks to form gangs often postpones or reduces services on other routes.

The second problem was created when eight to 10 trucks gathered and then returned to replenish their salt and brine loads. These trucks would encounter long cycle times to reload before returning to assigned routes. MoDOT needed a solution to reduce the number of trucks in gang plowing to maintain services on all routes. Plowing faster was not an option in urban St. Louis and Kansas City areas because of slower congested traffic. Adding more trucks was not desirable because additional operators were often not available. Hence, plowing wider became the only viable solution.

Most agencies utilize more wing plows to plow wider with each truck. This created several problems when implemented. Wing plows are not forgiving when an obstacle is hit, which often damages the wing plow components and can bend the truck frame. Either or both can cause the truck to be out of service for days to weeks.

Operators cannot see a wing plow on the right side of the truck. Wing plows have been hit by vehicles trying to pass the snowplow truck on the right. Plows are either up or down, with little to no ability to vary the plowing width.

Wing plows were not designed to clear pavements. They continue to serve very important functions to push back high drifts and clear beyond shoulders at slow speeds. They can clear pavements and shoulders at speeds less than 30 mph, but encounter problems at higher plowing speeds. Divided highways require higher speeds (see [Figures 1 and 2](#)).



FIGURE 1 Conventional gang plowing.



FIGURE 2 TowPlows in gangs.

The creation of the TowPLow (TP), a trailer plow, solved many of the problems. The TP truck combination can clear 26 ft wide with one operator and replaces two and half standard snowplow trucks operating in a gang. This concept not only plows wider but also assures accurate spacing and overlap, where most gang plowing trucks often overlap 20% or more. Adding a TP truck can release two trucks from the gang plowing operation to perform plowing on other routes. The TP truck combination can vary its plowing width from 10 ft to a path of 26 ft by steering the trailer with one hydraulic lever. Operators can vary the width, as needed, within these ranges. An operator can drive and plow the driving lane, while the TP clears the shoulder and steers around parked cars and other obstacles when needed.

Equipping the trailer plow with a brine tank provides good conspicuity to the front and rear, when the unit is deployed. Tanks were originally installed to provide a visual presence to discourage approaching vehicles from passing on the right. Agencies are now using the tanks for brine anti- and deicing efforts. An enhanced design now provides 8 cubic yd of salt or other mixed materials on the trailer. The material spreader serves the same purpose in discouraging drivers from passing and hitting the moldboards.

The trailer design hooks to the host truck just like any pup or other trailer, using standard hitches and air brake systems with antilock braking system. The TP is less than 102 in. when towed. Agencies only have to modify the host truck to provide two hydraulic circuits to the trailer, one for lifting the moldboards and the other to steer left and right. Most trucks with wing plows can be readily converted to TP trucks, by using the existing wing plow hydraulic circuits.

Operators, who have operated wing plows in gangs, quickly transition to a TP clearing 26 ft wide. Wing plows are difficult to impossible to see from the driver's seat. The trailer plow can be viewed using power mirrors to track the variable width as needed.

ADDITIONAL PRACTICAL USES FOR TRAILER PLOWS

The use of gang plowing and requiring multiple passes occur at other sites. Snowplow trucks have to also clear entry and exit ramps. These trucks either plow and then back up against traffic or travel long distances to turn around and return to make another pass on the ramps. A TP truck can clear 10 ft, flair out to clear 26 ft and then transition as needed to pass through narrow lanes with adjacent islands. This variable width ability and the fact the TP is less than 102 in. wide, may solve the problem of snowplow trucks having to pass through limited width toll booth lanes. Variable plowing widths, from 10 to 26 ft and back to 10 ft, are achievable in less than 150 ft of travel.

Some states have climbing lanes, which require snowplow trucks to return to these isolated areas just to plow these special lanes. A TP truck can plow one lane, then flair wide to clear the climbing lane and then transition back to clearing one lane, providing one pass service.

A few states have implemented periodic passing lanes. These routes are three lanes wide, allowing one direction to pass for 4 mi. Then, lanes are remarked to allow the other opposing direction to pass for the next 4 mi. This causes situations where one needs to plow two lanes for 4 mi, then one lane for 4 mi, alternating throughout the route, repeating the practice on the return trip. The trailer plow truck combination eliminates the need for the second round to clear these extra lanes.

SAFETY ASPECTS

Wing plows are firmly attached to the truck and are not forgiving when they strike obstacles. TPs use the standard trailer hitch, which is pin connected to the truck. This prevents any transfer of moment loading to the truck and provides flexibility when striking obstacles. TPs have struck guardrail ends without any affects upon the towing truck. The moldboard ends were slightly damaged, but remained in service.

Wing plows are difficult to stabilize to prevent hopping at higher speeds. TPs have proven to be stable above 45 mph, potentially providing the means to plow rural Interstates at much higher speeds. This feature may allow TP trucks to approach traffic speeds, which can improve safety and reduce accidents.

ECONOMICS

The additional cost to upgrade from 11- and 12-ft plows to 14-ft front plows is less than \$400 per foot. The use of 14-ft plows, in lieu of wing plows, reduces costs. Operators tend to be more comfortable with front plows compared to wing plows, which they cannot see mounted on the right side of the truck. Some agencies provide dual truck steering at a cost exceeding \$3,000 per truck, which allows an operator to use the right steering wheel when operating a right wing.

The implementation of a TP can reduce the need for capital funds by reducing the number of snowplow trucks. This concept can reduce an agency's capital investment needs by 20% to 30% and still achieve the same amount of work. One can attach TPs to trucks and increase services without adding trucks and operators. Hence, increasing plowing production and reducing the number of required passes reduces truck miles and saves fuel.

CONCLUSIONS

Agencies will continue to struggle with increased customer expectations for snow removal. Plowing wider and then faster are the two primary solutions. Plowing faster with traffic is needed to assure traffic flow and provide assurance for just-in-time commerce. A future goal is to safely plow within 10 to 20 mph of the traveling public's speeds at all times. This goal can provide improved safety by reducing rear end collisions with snowplow trucks.

Implementing the concepts of using wider front plows and trailer plows will allow agencies to plow wider and faster to increase production and improve snow removal services, while utilizing existing manpower.

ACKNOWLEDGMENTS

The author acknowledges Wess Murray, MoDOT's Kansas City Metro superintendent, and Steve Rider, Viking Cives Midwest, Morley, Missouri, who provided the support and process to commercially provide the TowPLow, while meeting the challenging design and performance expectations of the author. This process has improved and forever changed the concepts of snow removal operations in the Show-Me State.

The author thanks and congratulates MoDOT, Wess Murray, and Steve Rider for the combined efforts to Provide Solutions for 21st Century Gang Plowing, which was recognized by the 2007 Governor's Award for Quality and Productivity for implementing new Innovations in Missouri State Government.

SNOWPLOW OPERATIONS AND EQUIPMENT

Global Positioning System–Controlled Salt Spreading

From Idea to Implementation

FREDDY KNUDSEN

BO SOMMER

Danish Road Directorate

Salt spreading controlled by Global Positioning System allows salt distribution on the whole road surface with automatic adjustment of spreading dosage, width, and symmetry while the driver concentrates on following the route. This technology is developed because automatic data collection from salt spreaders has shown that even skilled drivers can't adjust spreading width and symmetry in a proper way and drive the truck at the same time. In the long term the technology is essential to implement salting with different dosages based on prognoses for the salt needed along a route. Today the same dosage is used on the entire route even though we know that the salt needed won't be the same.

Salt spreading controlled by Global Positioning System (GPS) allows salt distribution along the whole road surface with automatic adjustment of spreading dosage, width, and symmetry while the driver concentrates on following the route. This paper describes the background for developing this technology and the future use of it to ensure different salt dosages along the route depending on forecasts on section level.

WINTER SERVICE IN DENMARK

Denmark is a flat country situated in the northern part of Europe, with a typically coastal climate. The country covers an area of 44,000 km². The highest point is just 173 m above sea level. Denmark has two main road authorities:

- The Road Directorate is responsible for 3,800 km of state roads including 1,000 km of motorways and
- 98 municipalities are responsible for 68,000 km of paved roads.

The main winter problems in Denmark are hoarfrost and freezing wet roads due to temperatures typically floating from plus degrees in the daytime to minus degrees during the night. We have approximately 100 salting actions and 5 to 10 days with snow and in total just 30 to 50 cm of snowfall per season. The snowfall can vary from nearly nothing to several meters.

The Danish Road Directorate operates six 24-h winter centrals that are responsible for the winter service on the state roads. They decide when, where, and how to call out for salting and snow removal. Private contractors deliver trucks including drivers ready for operation 24 h a day from October 1 until April 30.

At the winter central the personnel on duty operate two software tools. They are using VejVejr, a road weather information system (RWIS), to assist in making the right decision about when and where to go. When the decision is taken, they are using Vinterman, a winter maintenance management system (WMMS), to handle the call-out and registration of all ongoing actions.

On all main roads salting is done as preventive action before a slippery situation occurs. Salt is spread across the entire road profile by letting the driver adjust spreading width and spreading symmetry along the road while he or she drives the truck.

MOTIVATION

Vinterman had automatic data collection from the salt spreaders since 1998. It has a general interface to the spreaders to ensure presentation of data from different manufacturers within the same software. Figure 1 shows an example of the data collection from one salting action. This detailed documentation shows all spreader settings made during the route with red dots during salting and smaller black spots for transportation.

In Figure 1 the speed, spreading width, and spreading symmetry are shown as a graph. It is obvious that the spreading width is adjusted regularly while the buttons for adjusting the spreading symmetry are never touched. This is a very typical situation, which means that bus stops, turning lanes, etc., only rarely are treated as they should be. Analysis has shown that less than half of all necessary adjustments are made by even very experienced drivers.

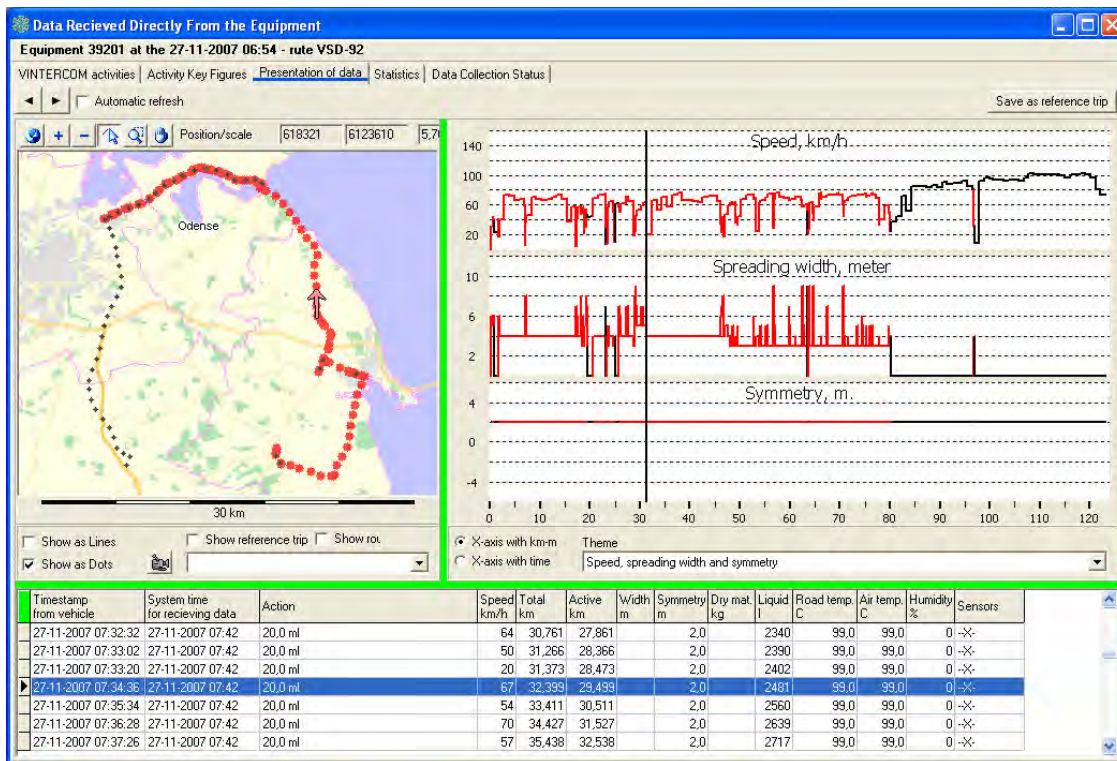

FIGURE 1 Detailed data collection from one route.

The reason for the lack of spreader adjustments is simple. It is very difficult or almost impossible to make all adjustments correctly through a junction with turning lanes, etc., at a speed of 50 to 60 km/h and still be able to handle the traffic situation. In Denmark it is forbidden by law to handle a mobile phone during driving. Letting the driver do five adjustments of spreading width and symmetry during 7 s while passing a junction is not forbidden but will never improve traffic safety.

The conclusion at that time was that a system for automatic adjustments of the spreader would improve the quality of the salting action by getting salt where it is needed and only there. At the same time it would have a positive effect on traffic safety if the driver wouldn't have to adjust the spreader control box.

Based on this the project, spreading controlled by GPS was initiated in Denmark in cooperation with the salt spreader manufacturers on the Danish market. During winter 2004–2005 the first products were available, and we had two different products running. In the winter of 2007–2008 we have GPS-controlled spreading at more than 70 routes in urban areas and in open land.

The four products are a little different in development state and usage, but the basic principles are the same. The next section is an introduction to how GPS-controlled spreading is set up by using the Epoke equipment, which is most common.

HOW DOES IT WORK?

The first stage is to record the route with all the correct settings for the trip. This normally takes place with a salt spreader simulator installed in an ordinary car. The route is driven together with a driver experienced on the route. The driver just makes all the settings without driving. When recording the speed is lower at junctions, full stops can even occur to ensure registration of all the correct settings with a high level of accuracy. The recording can also take place in a truck with a traditional spreader, but a patrol car with beacon light and a simulator is normally more practical. It is in general worth spending time on making the recording as perfect as possible.

After the route is recorded, it is transferred to a PC by using a memory card. At the PC the route can be presented including all the settings. Within this software the route can be fine-tuned afterwards by adding extra settings or moving the position of a setting a little. In the first versions of GPS-controlled spreading it was not possible to adjust the recorded trip, but this has been necessary to handle minor adjustments without recording the entire route again.

When the recorded route is adjusted in the PC software, it is transferred to a real salt spreader by a memory card. At this stage it can be stored in different versions, e.g., with different dosages. After this, the driver just has to select the correct entry when he or she starts salting, and the spreader will by itself change dosage, symmetry, spreading width, etc., while the driver just drives the route.

After software installation it takes about half a day to record, tune, and install a route into a spreader control box ready for use as GPS-controlled spreading.

On the basis of experience, routes in open land through small cities have about 200 changes in settings, and routes in urban areas have up to 700 changes in settings. In both situations it is routes of 2 to 2½ h of driving (Figure 2).

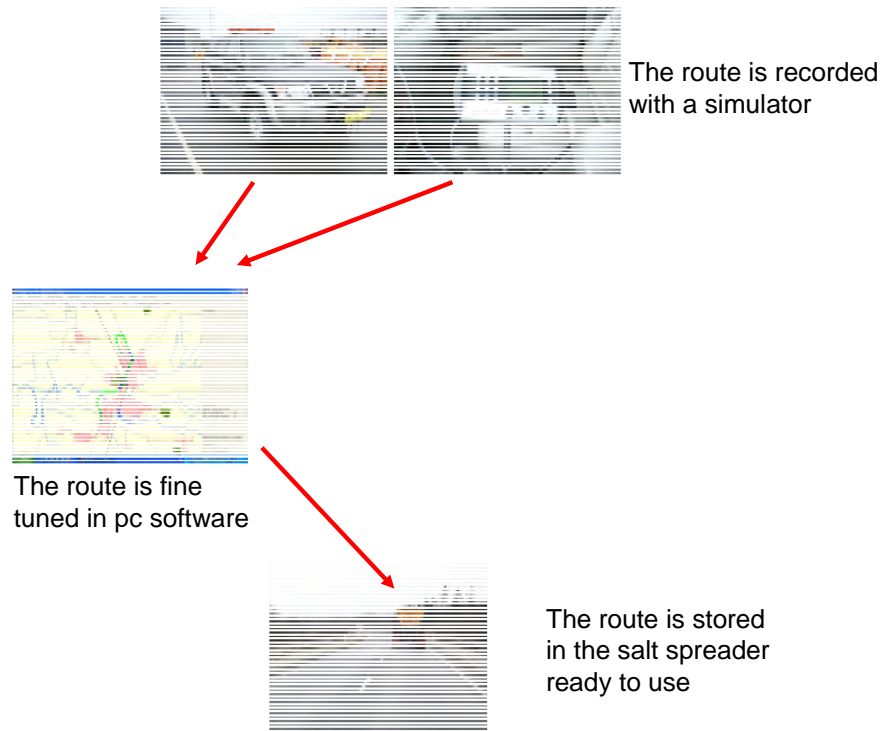

FIGURE 2 Preparation of a route to GPS-controlled spreading.

OPERATION AND ACCURACY

When the project started, focus was on two important factors. The accuracy and stability were important to ensure, and the system must be easy and intuitive to work with during the daily operations. In the initial specification of GPS-controlled spreading, the accuracy was defined as a precision within 5 m. Because of the mechanical element of a salt spreader, a change in spreading width cannot take place instantly. A length of 5 m is equal to 0.3 s of driving at 60 km/h. Neither the driver nor the mechanics can do adjustments more precisely than this today.

In the daily operations it has been an important requirement that the driver can override the automatic replay, e.g., with symmetry changes due to heavy side wind or by pressing “max dosage” at places with drifting. In the same way the system must work adequately if the driver leaves the route and returns later. This could be in situations with temporary closed roads or when he or she needs to stop for fuel, or food, or to go to the depot for reloading.

The different products have met these challenges in different ways. But until now we have seen the requested accuracy. At least one product used special algorithms to improve the accuracy of the GPS signal in combination with speed-dependent settings where the speed can take the mechanical delay into calculation. This combination has given a very satisfactory accuracy.

During the first recordings of routes it was clear that it was not possible for a driver to make all the adjustments at the control box beforehand. On average there have been between two and six changes in settings per minute, but most of the adjustments are usually concentrated, e.g.,

at junctions. When salting at a speed of 50 to 60 km/h (~15 m/s), there might be need for four to eight adjustments on the control box within a few seconds.

Figure 3 shows an example of a normal T-junction with a divider and turning lanes, etc., from one of the first routes that got GPS-controlled spreading. At a speed of 50 km/h it takes less than 7 s to pass the entire junction, and at the right side the drivers needs to make in total five adjustments of symmetry and spreading width. Figure 3 is a simplified sketch from a route in Ribe. A short video from this junction is available on the Internet at www.vejsektoren.dk/wimdoc.asp?page=document&objno=59916. From this link please select “GPS styret spredning, klip fra Ribe.”

The drivers of the salt spreaders have been very positive about this new technology. It makes their job easier and gives them more time to focus on the traffic and just surveying that the spreader is “doing its job.” Even experienced drivers are saying that salting by using GPS-controlled spreading gives a better result than they ever would be able to produce without it.

SECTION-BASED PROGNOSES

In Denmark there are approximately 325 road weather information stations distributed along the road network. For each station we do have prognoses for road temperature, dew point, etc., to ensure a good base for the decision about salting or not. These measurement stations are usually placed at cold spots while the road temperature between these stations is usually higher.

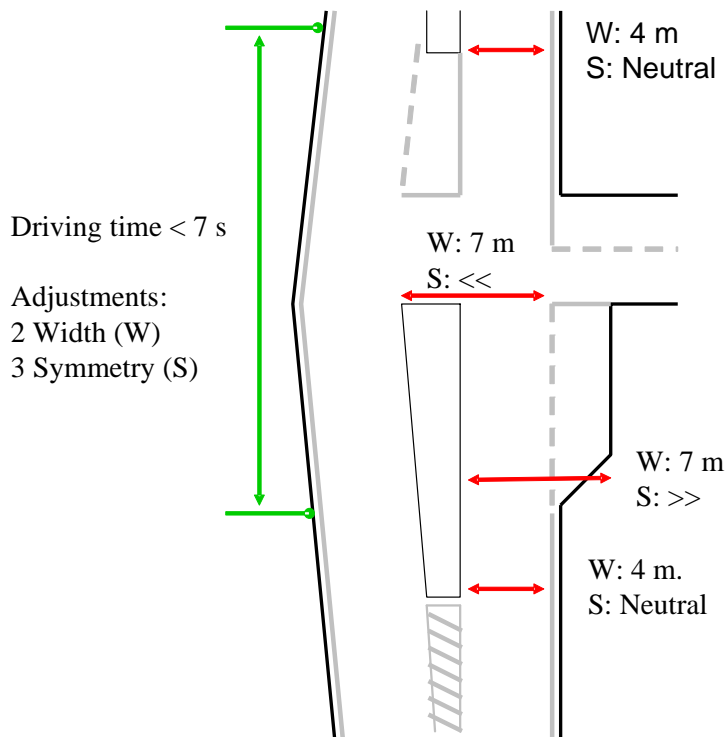

FIGURE 3 Example of changes in spreading width (W) and symmetry (S) through a T-junction.

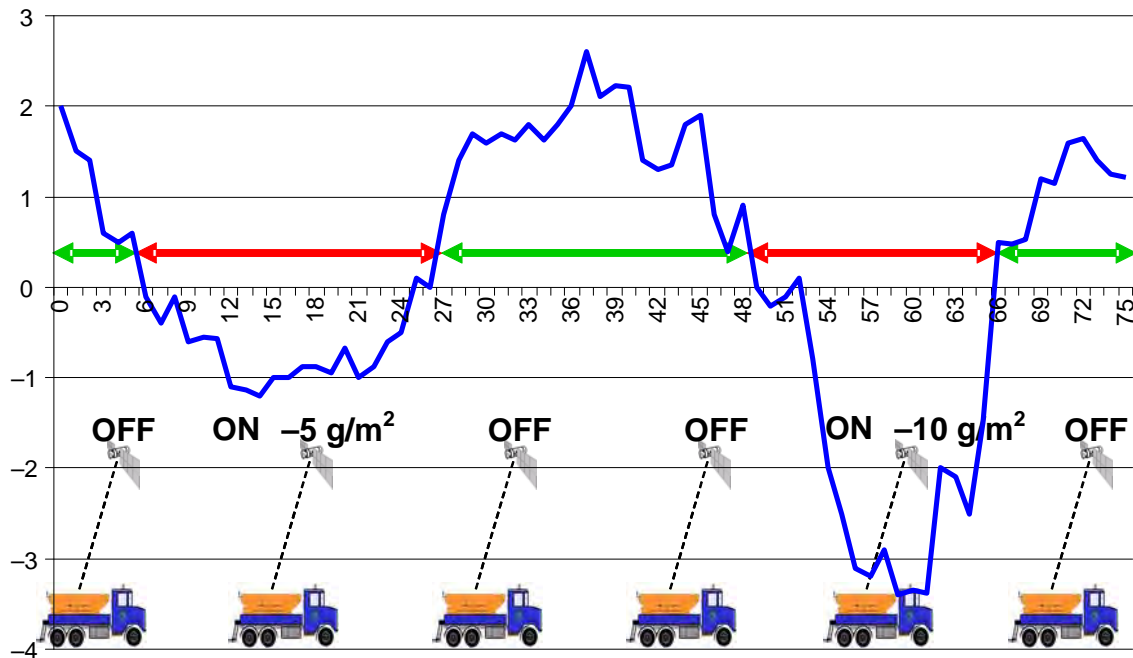

FIGURE 4 Forecast for temperature profile at a route and corresponding salt dosages.

Today most spreader manufacturers can deliver a tool to change the dosage according to the present road temperature by using a sensor mounted on the truck. During preventive actions it will be much more beneficial to be able to salt according to the prognosis for the road temperature during the entire route. Figure 4 shows an example of a 75-km route where the temperature even in a flat area can vary up to 7 degrees. In the figure the temperature forecast is shown together with the corresponding salting dosages. Normally the dosage will be the same during the entire route because we have forecasts only on station level, which usually will be at the two coldest spots.

At the moment the Danish Meteorological Institute is working with a model to develop section-based prognoses and by making them available in our RWIS. Being able to make a section-based model demands a lot of temperature measurements along the route at different weather conditions. This can be done by a separate vehicle, but today we equip new spreaders with temperature sensors that automatically send measurements together with the data collection from each action. This gives approximately 100 temperature profiles for each route per winter season.

Section-based prognoses are still in a development phase. But to benefit from this it is important to have GPS-controlled spreading as the tool that ensures the different dosages along the route.

SNOWPLOW OPERATIONS AND EQUIPMENT

Tools to Gain Faster Snow and Ice Response While Ensuring Preservation of Equipment *Especially with Part-Time or Seasonal Snowplow Operators*

LARRY E. NELSON

Minnesota Department of Transportation

The public, with the full attention of the media, is demanding ever faster response times and requiring ever higher standards of management of the snow and ice (S&I) events that affect our roadways. Many departments of transportation (DOTs) or public works departments are asked to meet these demands even though they are faced with fewer full-time operators and an increasing proportion of part-time or seasonal crews, who often are not as familiar with the S&I equipment as the full-time operators. Determining proper use of the many chemical options can be challenging for an operator, especially when being asked to factor in material costs and sensitive environmental protection measures. As if that weren't enough, new engine technologies and lubricant requirements can be overwhelming and cumbersome to apply correctly, even for the experienced operator. Improper use can result in dangerous conditions (as with 1,200-degree exhaust in some 2006 and newer engines). The use of specially designed and manufactured synthetic lubricants, while superior in performance, can result in very significant repair costs if improperly employed. Even new engine coolants pose a threat if misused. The complicated variety of new brake components can cause both compliance and safety issues. To address these problems, the Minnesota Department of Transportation (MnDOT), with the blessing of the Minnesota State Patrol Commercial Vehicle Section, developed a set of clear-cut tools that comply with federal motor carrier safety regulations, state laws and regulations, and MnDOT agency policies. These tools have been in place for 4 years and have yielded excellent results. Perhaps most noteworthy, they don't cost more money—they in fact save money. The results include (a) intermittent operator efficiency gained; (b) S&I vehicle preparation time, with both full-time and intermittent operators, reduced from 20 to 30 min to 5 to 10 min; (c) equipment better maintained; (d) operational costs reduced; (e) downtimes reduced; and (f) compliance and safety improved. Proper use of the following tool set is explained, providing examples, sample forms, and instructional documents: (a) unit-specific data—complete, quick, and easy operator–mechanic access; (b) commercial motor vehicle inspection–scheduled interval servicing—accuracy–efficiency combo; and (c) procedural example—abbreviated air brake inspection.

It can be quite discouraging when enumerating the many and varied challenges in responding effectively to snow and ice (S&I) events on public roadways, including these:

- Compensate for new, part-time, or seasonal operator inexperience,
- Enhance public relations while simultaneously improving operational costs, and
- Comply with requirements for a commercial driver's license (CDL), commercial motor vehicle (CMV), or federal motor carrier safety regulation (FMCSR) requirements and meet safety objectives.

However, this paper may bring encouragement through the demonstration of some easy-to-use, low-cost tools that can be quickly tailored to the uniquely differing operations found in various agencies. A lot of attention has been given to S&I chemical usage. Looking at another area where the results could pay huge dividends but cost little or nothing appeared worth a review. This tool set has been successful in exceeding original objectives.

As will be readily seen, most items presented for consideration are already given substantial attention by most agencies. The difference presented here is the manner in which the desired work was accomplished. That, not increased effort or cost, accounted for the improved results gained in Minnesota Department of Transportation (MnDOT) trials.

The tool set revealed in the following pages aids both intermittent and full-time operators. Furthermore, it assists agencies in compensating for new employees, who may lack awareness to perform thorough vehicle inspections. It specifically targets operators required to inspect and service trucks, especially CMVs, before and after trips. Field-proven methods speed up preparation times—resulting in faster S&I event response. They ensure preservation of equipment—saving operational costs. In addition, agencies and operators alike are assured of safer, easier compliance with federal, state, and local CDL/CMV/FMCSR requirements. Sample forms and true-to-life examples will be presented to facilitate adaptation to specific organizational needs.

It is vital to establish the scope of the problem. Field supervisors may be all too aware of the challenges; however, it may be helpful to managers to peruse this document to gain a closer overview of the extent of need. To accomplish this, one can examine a few of the major challenges. These challenges have been growing exponentially in size and number for years, and may seem nearly insurmountable to many servicing agencies.

As previously mentioned, a primary challenge is public pressure to maximize response to S&I events. And no wonder the public is demanding more. Citizens appear to be justified in many cases. For example, in major metro areas, a delay of as little as one hour in getting employees to work on time can have a huge economic impact via lost wages, sales, and production that can easily reach into the millions of dollars—in many instances exceeding the responding agency's entire winter season S&I budget. Timely response during a S&I event can provide one of the best returns on investment a taxpayer can receive from tax dollars. One DOT calculated that saving people in its metro area 1 h in arriving at work in the winter could pay back nearly every tax dollar paid for S&I. All the rest of the S&I cost figuratively was “free” to the public from that point forward. Maybe it's time agencies fully educate the public of this fact and garner some positive public relations.

Many agencies are required to meet public demands regarding S&I regardless of ordeals often encountered filling complements with qualified snowplow operators. In addition, a person who typically “drives a desk” or who plows snow only intermittently is seldom as proficient as a full-time operator, and likely causes significantly more damage to equipment in the harsh winter operating conditions. Quality, quantity, and promptness of event response can suffer noticeably. Furthermore, there are those who are mandated to perform S&I duties even though they fear or resent them. A 93-lb administrative assistant may fear driving a 56,000-lb truck. An engineering specialist may resent driving any truck when continuing to feel pressure to perform numerous engineering duties. This manner of cross-investing employee resources may not be preferred by managers, yet budget constraints have fostered this trend in many areas.

To complicate matters further, chemical choices, application procedures, new engine technologies, and new lubricant requirements can paint a confusing scenario. A heretofore

simple act such as adding correct engine oil can be puzzling—no more just popping in a gallon of 10W50 standard motor oil.

Many are surprised to learn that new engine coolants can pose a threat. Gone are the days of merely adding some green-colored antifreeze when the radiator gets low. There are at least three common, not always compatible, types and colors of antifreeze today.

The array of new brake components (short stroke, long stroke, drum style, disc style, etc.) can be difficult to sort out, even for mechanics. An operator is deemed responsible for CMV brake compliance under FMCSR or state CDL regulations, yet may be unable or even unaware of how to make the determination of compliance or (alarmingly) safety.

Bearing rules, regulations, laws, and policies in mind, and being aware of their complexity, it is no wonder the average operator often cowers at accepting responsibility for compliance with them all. To illustrate, MnDOT has a comprehensive training program called SPOT, an acronym for snowplow operator training. To complete the program successfully, each trainee must pass three tests: an FMCSR written test, a hands-on vehicle inspection test (pre and posttrip), and an American Trucking Association road test. The most feared portion of the testing is surprisingly not the road test. It is hands down the vehicle inspection test, and that is because of the many complexities previously described.

In the present environment, many agencies can cite personal examples of operator overload. One state DOT told of operators feeling so inundated by the myriad of details that they quit on the spot, leaving their snowplows to be picked up on freeway ramps. That same DOT told of having to train nearly 600 temporary operators before each winter season, and their only previous experience may have been as pizza delivery drivers or small van couriers. The situation is reminiscent of words someone once quipped “They are expecting us to do more and more with less and less” and then added “Soon they’ll expect us to do everything with nothing!” This doesn’t mean it’s easy for full-time, experienced operators. It is not. The sheer number and complexities of aspects are daunting even when fully comprehended. As agencies proceed, it is hoped that keeping in mind the challenges will sufficiently highlight the need so that it inspires agencies to formulate plans of action.

UNIT DATA SHEET

When the wide array of challenges is summarized this way, one can garner a good overview of the complicated type of environment an operator faces when asked to perform S&I duties. Despite this, there is good news. Ways can be found to help get a handle on some of those challenges. A tool set that can aid in the often dreaded area of vehicle inspection follows. The first tool is the unit data sheet ([Figure 1](#)). Though not unique in its contents, it can be unique in its methods of application. Instead of the information contained thereon being stored away in a file cabinet or stuck in a glove compartment, the model MnDOT has adopted affixes the unit data sheet to the left side of the operator’s seat for easy viewing. Laminated and riveted in place, it is not likely to get lost. To preserve accuracy of the information, unit data sheets can only be made and placed by authorized mechanics.

Imagine how the unit data sheet works. One quick glance produces a wealth of vital information. There is no more struggling in a dark shop to see proper tire inflation information that is stamped in hard-to-read black letters on a black tire. Proper inflation, of course, means increased safety and longer tire life. Exact tire sizes plainly listed should eliminate installation of

Unit # 209144 (sample)
Class: 33 **Plow #:** 209145
Wing #: 209146 **Sander #:** 209147
Antifreeze: yellow
Power steering: power steering fluid
Engine oil wgt.: 15W40
Transmission: ATF (red)
Front hubs: 50W synthetic
PTO: 75W90 synthetic
Lug nut torque: 450 dry, 500 wet
Hydraulic: standard (red)
Differential: 75W90 synthetic
Grease: chassis (red or black)
Special grease: none
Tires: (size, load range, air pressure)
 - Front axle: 315/80Rx22.5, L, 130
 - Rear axle(s): 11Rx24.5, G, 100
Brakes: (maximum stroke)
 - Front: 2" - Rear: 2 ½"

Form 3133 T
Unit Data Sheet

Rev. N 10-11-06



FIGURE 1 Unit data sheet.

incorrect tires and prevent mismatches that can lead to dangerous blowouts. Facts such as specified wheel lug nut torque can be hard to locate and thus perilously ignored. Inattention of this nature can be disastrous.

Being able to read exactly the type of fluid to add to a specific vehicle assembly can prevent contamination from incompatible fluids, resulting in reduced service life and possibly costly repairs, especially with engines, transmissions, and other drive train components.

S&I components are usually removed when no longer needed for the next season. Identifying parts (such as plows, wings, and sanders) and listing them on the unit data sheet can save many hours and much frustration in attempting to match and fit parts when time for installing them again returns.

Knowing the proper brake stroke length can ensure both safety and compliance with regulations. As many have learned the hard way, this is one of the first areas checked and most often found noncompliant when accident investigations are performed. Improper brake adjustment can not only result in heavy liability costs but also can be a major contributing factor to serious injury or loss of life.

1,000-mi SERVICE RECORD

As one can see, the unit data sheet provides a key tool but can be appreciably more powerful when linked with another member of the tool set named the 1,000-mi service record (Figure 2). The "1,000-mi" in the title is no cause for concern. As managers learn what is intended, the determination may be made to tailor the forms with 2,000-mi, 5,000-mi, or 100-h, 200-h, etc., intervals. Depending on equipment type and use, one of the benefits of this kind of form is that it can be adapted for use with various equipment types.

1000 - Mile Service Record
Class 33/35 (non-plow CMVs @ 4000 miles)



Unit # _____
Date: _____ **Mileage** _____

- Review Operator/Service Manuals
- Review Operator's Vehicle Inspection Report for defects/problems
- Review Unit Data Sheet
- Conduct a **THOROUGH** pre-trip vehicle inspection (FMCSR 396)

Fluids/Lubricants: (FMCSR 393)

- Windshield washer fluid level
- Antifreeze level and strength
- Power steering fluid level
- Engine oil level
- Transmission fluid level (hot)
- PTO pump fluid level
- Front hub lubricant level
- Hydraulic fluid level
- Differential(s) lubricant level
- Grease chassis, box, and all components (wing, sander, etc.)

Brakes: (FMCSR 393)

- Spring brake operation
- ABS warning light indicator
- Low air pressure warnings activate at _____ p.s.i.
 - Buzzer
 - Light
- Governor cut out p.s.i.: _____ (should be 105-135 p.s.i.)
- Governor cut in p.s.i.: _____ (never less than 80 p.s.i.) (difference between cut in and cut out should not exceed 25-30 p.s.i.)
- Compressor air pressure build time from 85 to 100 p.s.i. _____ (must be 2 minutes or less with engine idling at 600 to 900 r.p.m.)
- Brake linings (pads) (no less than 1/4 inch remaining)

- Brake push rod stroke:
 (maximum inches of travel with 100 p.s.i. full application of foot brake)
- #2 axle driver side: _____
 - #2 axle passenger side: _____
 - #3 axle driver side: _____
 - #3 axle passenger side: _____
 - #1 axle driver side: _____
 - #1 axle passenger side: _____
 - Air tanks: drain moisture (wet tank first), check for excessive water or oil

Other: (FMCSR 393, 396)

- Tire pressures: check with gauge
- Check tires for tread depth, cuts, bulges, nails, etc.
- Check all lug nuts with torque wrench
- Exhaust system: damage, leaks
- Air cleaner restriction
- Battery: water level, corrosion
- Clean cab interior and windows
- Brake pins: free up and lube
- Fuel water separator (drain if needed)
- Air dryer heating element connection
- Breathers: PTO, AT, differentials
- Write Unit Service Request, if needed
- Write Unit Service Report for oil change or other service

Comments:

Unit serviced by:

(legible signatures, print also if necessary)

1. _____
2. _____

FIGURE 2 1,000-mi service record.

An agency may charge a mechanic with many of the responsibilities on this form. If so, it can be easily modified to fit any situation respective of designated operator or mechanic roles. To enable this tool set to work as designed, however, this information should be readily available by pretrip inspection time. At MnDOT, to minimize mechanic expenses and maximize operator efficiency, operators perform the items listed on the 1,000-mi service record.

Perhaps most important, this form is used as a checklist to ensure that all components are inspected and serviced completely and correctly, whether done by mechanic or operator. This is obviously important for preservation of equipment and saving costs, but it is paramount for operator and public safety. Regulatory compliance is thereby maintained and documented. Such information should never be assumed. Pertinent date and mileage information can be referenced quickly to be sure the inspections are current in addition to being complete, a pivotal point in solid defense during litigation.

The top left of the form lists a full CDL type inspection, which includes those items done on a standard pretrip inspection. This is the time to catch and attend any problems found—not wait until immediately before placing the unit into active service. Free from the time pressures of urgent work demands, a thorough inspection can be more diligently performed. The vehicle can be cleaned and placed on a hoist. Drop lights can be used for better viewing. As items are completed, the form is appropriately marked. For a form to be deemed totally complete, all boxes () must be noted in writing with predetermined, uniform markings. Suggested markings are printed at the bottom of the 1,000-mi form with this key:

Checked/OK/Complete **NA** Not Applicable Not OK/Defect/Problem

The scheduled servicing opportunity provides an ideal time for tires to be closely inspected for nails and cuts; any inside damage can be more easily seen. Leaks around transmission seals or hydraulic hoses can be more readily found. Cracks in frames, springs, etc. are easier to discover. Wear or chafing on wires and hoses can be seen with less difficulty. Brake shoe inspection holes can be optimally viewed from both top and bottom locations. Automatic transmission fluid (ATF) can be checked in accordance with proper warm-up procedures.

Those fluid levels and components not easily accessible or not required to be inspected on the abbreviated pretrip (e.g., differential fluid), can be conveniently checked. Parameters such as those for air compressor strength and air pressure system governor limits are listed for quick reference. When these lengthy checking procedures are necessary, they can be completed with sufficient time to perform them thoroughly.

Some special notes when measuring the brakes: chock the wheels and fully release both service and emergency brakes. After measuring and recording brake stroke length at all wheel positions, it is more convenient to solicit a helper for the brake applied measurements. Because of the danger from moving parts, explicit instructions are recommended. For example, set the air pressure set at a benchmark 100 psi. Next, instruct the operators to give the helper complete directions similar to the following:

Get into the driver's seat and touch no controls until I tell you. I don't want to be hurt by moving parts. When I tell you, push the service brake all the way to the floor and hold it there. Do **not** release it until I tell you. I will be measuring all wheel positions before I stop, so be aware that this will take a few moments. I'll tell you to release only when I'm done. Do you have any questions?

The reason for listing the axles on the form in the order of 2, 3, 1 is purely a courtesy. The helper's leg can tire while maintaining constant, full-service brake application pressure during the entire time needed to finish a measuring sequence. The recorder's assuming a position on the shop floor and under the truck (ready to measure at the driver's side #2 axle) permits easier communication and speedier recording and thereby reduces helper leg fatigue.

Numerous other safety, operating, and maintenance checks can be performed at the 1000-Mile interval, which would not be time effective or even necessary to perform at each pretrip. Attention here reaps significant time and cost savings. Examples of other items to be addressed are moisture in air tanks, air dryer function, lug nut torque, exhaust system leaks, battery corrosion and water levels, brake pin lubrication, greasing, and cleaning of the entire unit inside and out—including windows and mirrors.

A space is provided for comments in case the person inspecting and servicing the unit wants to convey information to future operators. An example would be a note stating that a brake push rod stroke was nearing the outside limit and should be checked within the next 100 mi to ensure that the automatic slack adjuster makes the appropriate adjustment.

Space is also provided for signatures of those performing the inspection and service work, thus making available the names in the event other operators need to ask questions of them. More important, it adds accountability that can easily be verified by a supervisor or CMV enforcement officer.

INSTRUCTIONS FOR THE 1,000-mi SERVICE RECORD

To be fully effective, the 1,000-mi service record (Figure 3), or a similarly designed replacement form tailored for an agency's specific requirements, should be accompanied by a set of fundamental policies. Policy samples are shown in the following paragraphs. When the final format is determined by management, blank forms are presented to operators and other service personnel by supervisors. A form is completed during each service. It may serve as a checklist while the activities are being performed. When fully complete, a photocopy is made and placed in a common, easily accessible location (such as the driver's door pocket) in the cab of each unit. The original is filed in an office file accessible by operators. In this way, if the copy in the unit is lost, a new copy can easily be made and substituted in the vehicle.

The 1,000-mi interval inspections may be knowingly missed if they occur in the midst of S&I or other emergency operations. On the basis of the history of the unit and the determination of the supervisor or a designated knowledgeable and responsible employee, the unit may be operated until 1,000-mi servicing can be performed. Of course, judgment must be used regarding how long the unit may continue without full maintenance servicing. However (this is of crucial importance for safety of operators and the public), pretrip inspections must be performed as usual and brake measurements must be done during the posttrip inspection as close as possible to the 1,000-mi interval. A new form is used to record brake push rod stroke measurements. This is the only section completed on the form since this is the only work done. A photocopy of the dated and signed form should be made and attached to the front of the previous form in the unit. Any future operator can readily note, by the incomplete front form, that servicing must be performed as soon as possible. As previously done, this new original should be attached to the front of the original office copy and filed. Continue in this manner, as long as the supervisor deems it a prudent priority because of the urgent event, until the unit can feasibly be scheduled for service.



INSTRUCTIONS

3134 – 1000 Mile Service Record

The 1000-Mile Service Record is to be provided to Operators, via their Supervisor, with these basic instructions:

- a. Complete a 1000-Mile Service Record at each service.
- b. Make a photocopy and place it with the Operator's Vehicle Inspection Report in the pocket provided on the drivers' door of each truck.
- c. Place the original in an office file accessible by Operators (in case they lose the truck copy, another can be easily made and re-placed in the truck).
- d. If the 1000-mile service interval is missed due to Snow and Ice or other emergency, a new 1000-Mile Service Record is to be used at the 1000-mile interval, or on the pre-trip closest to 1000 mile interval, completing the brake section only.
- e. Continue according to d. above, completing a complete brake check and new form every 1000 miles, or on the pre-trip closest to 1000 miles, until the unit is able to be scheduled for service – which the Supervisor will do as soon as feasible after the snow and ice or other priority event.
- f. If a form is lost and no copy is readily available, the operator will perform a complete brake check, which should include measuring the brakes, before taking a CMV on the road.

FIGURE 3 Instructions for 1,000-mi service record.

If a form is lost and no copy is readily available, the operator must minimally perform the required FMCSR pretrip inspection, including performance of a complete brake push rod measurement check, before taking a CMV onto the roadways.

PRETRIP BRAKE INSPECTION GUIDE

Since the brakes are fully checked at the 1,000-mi interval, an abbreviated method is made possible. However, because brakes are such a crucial factor in operator and public safety, functionality should still be checked immediately before operating a CMV on public roadways. FMCSR agree. A quick, easy, and thorough sample procedure is fully outlined in [Figure 4](#). Keep in mind, both service and emergency (park) systems should be verified. In some 2006 or newer CMVs, the transmission computer may not allow the park brake to remain applied when the truck is initially placed in gear. In that case, it is necessary to accelerate the vehicle to approximately 3 to 5 mph and then apply the emergency brake to test it. It should have the capability to stop the truck in an emergency as well as hold it safely when parked.

THE MAJOR TIME SAVER

Although one of the major time savers in using this tool set is getting ready for S&I, especially at the time of pretrip inspection, it can save significant time in other operations. This becomes very apparent when looking at an example like brakes. Their importance has already been referred to regarding safety, liability, and compliance. It holds true outside of S&I as well. FMCSR specifically state in Part 392.7: “No commercial motor vehicle shall be driven unless the driver is satisfied that the following parts and accessories are in good working order ... service brakes, parking brake ...”

Therefore, it can be interpreted that the only way a driver can be sure of brake compliance is to check them thoroughly; that can be construed as measurement of the slack adjuster push rod stroke. And that is exactly what used to be required at MnDOT for every pretrip inspection. Then came all the changes in brake styles, and along with them the difficulty in determining correct maximum stroke lengths. As if that weren't enough, the agency was deluged with non-traditional operators—part-time, temporary, and intermittent. Those folks could hardly be expected to wade through the complexities of compliance in the minimal time many spent on the job actually operating equipment. Something had to be done to shorten inspection times, preserve equipment, and maintain employee and public safety. This tool set was developed out of necessity. With it an operator can be confident in brake measurement without having to do it at every pretrip inspection. Knowledgeable personnel do, or assist with, the measurement. Pretrip inspection times have been cut by 50% or more, resulting in faster response time to an event whether it be S&I or another urgent incident. As everyone knows, minutes can be critical for saving lives when recovering a slippery road. Furthermore, compliance is assured. In any agency, it is recommended that compliance verification of agency policies be made with all federal, state, and local regulations. It is best to check all new policies with law enforcement, such as a state patrol commercial motor vehicle section.

Pre-Trip Brake Inspection Guide

Shop Air Brake System Inspection

Keep in mind there are two brake systems, Emergency brakes and Service brakes.

Emergency Brakes (Spring brakes) - are activated by pulling out the Parking Brake Control on the dash. Pulling it out will release the air from the Spring Brake System on the rear axle of the truck. With out air in the system, the spring will expand, thereby moving the push rod. This will then apply the brakes. Pushing in the Parking Brake Control will fill the system with air pressure, collapsing the spring, which releases the brakes and allows the truck to roll or move freely.

Service Brakes – are activated by depressing the service brake pedal. When the brake pedal is pushed, air pressure is sent to all brake foundations. The air pressure moves the diaphragms and in turn moves the push rods and s-cams, applying the brake pads to the brake drum. Releasing the service brake pedal allows air to escape from the brake foundations, releasing the brakes, which allows the truck to roll or move freely.

Sequence for air brake system check:

In the Shop

Air up system to maximum p.s.i. (100-120 p.s.i.) using shop air, then disconnect shop air.

With the system at rest, check for 2 p.s.i. air loss rate for one minute.

Release the parking brake and apply the service brake - check 3 p.s.i. air loss rate for one minute.

If the system is working properly, fill out the pre-trip inspection paper work and turn it in.

Start engine and gently move the vehicle to test service brake.

Drive the truck outside.

Outside - The truck must be on level ground

While moving, apply foot pedal to test the service brake. Feel for steering pull to either side.

Stop the truck and shut the engine off. Turn the key to the “on” position and pump the service brake pedal; check low air warning signals.

Turn the key “Off” and continue to pump service brake until parking brake valve applies (pops out).

Start the engine, put transmission in low gear and gently try to move the vehicle. If the vehicle doesn't move, the parking (emergency) brakes are working. (On 2006 or newer vehicles, it may be necessary to move the truck and apply emergency brake at 3-5 m.p.h.)

Allow the air system to reach maximum p.s.i. and continue on your way.

FIGURE 4 Pretrip brake inspection guide.

EXEMPT FROM FMCSR, NOT RESPONSIBILITY

Many states have adopted FMCSR because these regulations were seen as providing excellent safety guidelines. Some have not adopted them. They therefore may not concern themselves with time lost doing inspections, because they don't perform them to the extent suggested in FMCSR. The statement has far too often been heard that an agency is exempt from FMCSR and that it therefore does not have to comply. That point may be true technically. However, this does not necessarily absolve an agency from potentially huge legal liabilities incurred in an incident. Liability alone should be enough of a motivator to encourage all reasonable effort to comply with FMCSR.

But the most important reason of all to comply is seldom cited and sometimes not realized until it's too late. It is personal, moral responsibility. If a personal injury or death occurs, and any individuals or organizations do not do everything feasible and prudent to prevent it, the moral responsibility rests on them, even if they escape legal consequences. And that burden can be oppressively heavy. To illustrate, imagine an incident in which a snowplow operator fails on the pretrip to check thoroughly a truck that has faulty brakes, is unable to stop at a stop sign, then broadsides a school bus, killing seven children on board. A lifetime of personal guilt may be relieved only by the snowplow driver's own death. This is not the type of burden anyone wants to carry. That fact should sufficiently prompt anyone who possesses the responsibility for vehicle inspections and safety. That includes the managers who set policies and the supervisors who enforce them, as well as the mechanics and drivers who inspect, repair, and operate equipment.

FACTS INDICATING REDUCED FATALITIES

Attention to the procedures and regulations discussed in this paper can pay additional dividends. In release DOT 72-07, dated July 23, 2007, U.S. Transportation Secretary Mary Peters announced declining traffic deaths in 2006 leading to the lowest highway fatality rate ever recorded and the largest drop in total deaths in 15 years. Large-truck-related injuries also fell 15%. "Tough safety requirements and new technologies are making our vehicles safer and our roads less deadly," she said.

It should surprise no one that the crash facts attest to the practices cited in the previous pages. Every public agency holds inherent responsibility to find feasible ways to save lives and prevent injuries.

SUMMARY

Fast S&I response times are being demanded of agencies by the public. Many agencies are being asked to accomplish this with limited budgets and nontraditional, intermittent personnel who may lack equipment knowledge and experience. In addition, proper use of many new products and technologies can complicate the learning task for all employees. Safety guidelines such as FMCSR, state regulations, and agency policies may not be attained. Optimal procedures and policies may not be in place to counter these problems. This state of affairs can result in costly lost time, equipment damage, and poor public service.

Fortunately, ways can be found to address these issues. Procedures and forms in the attendant paper provide a tool set in the area of equipment inspections that have the ability to make positive impact on the situation. As hoped when the MnDOT project was conceived, S&I vehicle preparation times, involving both full-time and intermittent operators, were reduced approximately 50% overall by employing the tools.

RECOMMENDATION

The author highly suggests public service agencies consider this tool set as a primer for designing and initiating their own specifically tailored tool set. As has been shown, positive results can be realized in such wide ranging areas as public service, public image, operator efficiency, equipment maintenance, operating costs, down time, regulatory and policy compliance, liability, and overall efficiency.

Above all other factors, such a tool set can help managers, supervisors, mechanics, and operators fulfill their intrinsic moral responsibility to assure public and employee safety, including saving lives through faster, safer event and incident response.

This paper represents the results of research conducted by the author and his associates at the Minnesota Department of Transportation and does not necessarily represent the views of the entire agency.

RESOURCES

Crash Stats, Traffic Safety Facts. National Highway Traffic Safety Administration, July 2007.
DOT 72-07. Office of Public Affairs, U.S. Department of Transportation, July 23, 2007.
Federal Motor Carrier Safety Regulations, Part 392.7, March 13, 2006.
Publication HS 810 791, U.S. Department of Transportation, 2007.

Application of Weather Information in Transportation Agencies

APPLICATION OF WEATHER INFORMATION IN TRANSPORTATION AGENCIES

Guidance for Creating and Maintaining Written Snow and Ice Control Plan and Policy Documents

DUANE E. AMSLER, SR.
AFM Engineering Services

This paper discusses the importance, benefits, creation process, and suggested content of written municipal snow and ice control plan and policy documents. The experience and success of three diverse agencies is cited to highlight the importance and utility of these documents. The following suggested content sections are discussed in the paper: introduction, communication and cooperation, level of service, planning, record keeping, risk management, operations, specific treatment guidelines, snowplowing guidelines, materials spreading procedures, post-storm clean up and safety restoration, passive snow control, personnel or personnel management, equipment management, emergency operations, materials management plan (environmental issues), and appended information. The intent of the paper is to provide a fairly complete and comprehensive “cook book” for agencies to use in the development of their plan and policy documents.

Creating and maintaining an approved written snow and ice control plan is one of the most important things a winter maintenance agency can do for itself, its governmental entity, its community, and its customers. This paper is the result of an extensive literature and web search and the personal experience of the author. It is intended to provide guidance to winter maintenance agencies seeking to create or improve written plan and policy documents.

BENEFITS OF A WRITTEN SNOW AND ICE CONTROL (STORM MANAGEMENT) PLAN AND POLICY DOCUMENT

The primary benefits of creating a written plan and policy document include

- Agency managers and supervisors are forced to plan ahead. This avoids chaos when difficult situations arise and provides a framework for efficient and effective routine operations.
- As a result of a good planning process, there will be a higher and more consistent level of service that results in increased safety, higher mobility (in general and for emergency services), and fewer “lost” days for the business, education, transportation, and manufacturing sectors.
- Managers, supervisors, maintenance workers, and the governmental community at large, will all be on the same page in terms of policy, operational procedures, and operational issues.
- Exposure to tort liability will be limited if the plan is reasonable, has realistic goals, is resource driven, and is followed to the extent possible.

- The public will have a clearer understanding of agency operations. This will generally result in reduced complaints and request for service.
- The agency will have a forum for continuous improvement and a basis for comprehensive planning and training.

The benefits of governmental agencies, educational facilities, and major employers having a comprehensive written snow and ice control plans have long been recognized. Al Gesford, a technology transfer specialist with the Institute of State and Regional Affairs at Pennsylvania State University, is a long-time advocate of carefully crafted written plans and policies. He helped create the winter planning and organization section of the Salt Institute–local technical assistance program (LTAP) winter maintenance training program and prepared a training document entitled “10 Lessons For Winter Operations Survival.” This document focuses primarily on plan and policy issues. He has presented the essence of that document at many training forums throughout the country and has inspired many agencies to create written policy documents.

I was fortunate to be assigned the task of updating the written snow and ice control plan and policy for the New York State Department of Transportation (NYSDOT) in 1991. We employed a committee process to blend new technology and ideas with existing policy. The resulting document has stood the test of time well and has been revised only recently. I have had scores of occasions to provide expert testimony on that document as it related to particular snow and ice claims against NYSDOT. As long as the guidelines in the policy have been followed to the extent possible, there has been very little successful litigation.

The experience of three agencies that have crafted comprehensive snow and ice control plan and policy documents is instructive.

Indiana Department of Transportation

Tom Konieczny, LaPorte District highway management director for the Indiana Department of Transportation (INDOT), offers the following about the creation and implementation of a comprehensive snow and ice control plan and policy:

In 2000, after seeing many exciting innovations in snow fighting around the country, Indiana DOT made a commitment to modernize its winter maintenance efforts. We created a Winter Operations Team to review and disseminate information, which leads to recommendations regarding snow and ice removal materials, equipment, and activities. One objective was to provide more consistent service on a statewide basis. As part of this effort, the Team prepared a *Total Storm Management Manual* as a tool that provides guidelines and options in an effort to keep Indiana Highways open and safe during the winter season. The manual covers a wide range of topics: administrative and management issues, equipment, snow and ice control materials, weather information systems, storm operations, and miscellaneous issues such as training aids and reports. It is a resource that has everything needed in one location. It is both for the novice and the veteran. Although initially there was some reluctance to change, most of our employees have noticed a difference and have embraced our new direction. It has

delivered us from a reactionary agency to one that is proactive and innovative and striving to enhance safety, mobility, and economic growth for our customers.

Tom further indicates that most of the benefits listed above have, in fact, been realized by INDOT. The 2003 INDOT Storm Management Manual is available at <http://rebar.ecn.purdue.edu/JTRP/> under “JTRP Projects.”

Rockland County, New York, Highway Department

Charles H. (Skip) Vezzetti is the superintendent of highways for Rockland County, New York. Skip’s first exposure to the benefits of a written plan and policy was at an American Public Works Association (APWA) snow conference about 20 years ago, while he was highway superintendent for the Town of Orangetown, Rockland County. He remembers the liability-limiting potential as being a good reason to start the process. With broad-based input, he crafted a written policy for Orangetown. The scope of the policy grew and eventually contained a comprehensive materials management plan that allowed the town to win several Excellence in Storage awards from the Salt Institute. During his current tenure with Rockland County, he created a similar, but more comprehensive, written plan and policy. That policy is on the county web page at: www.co.rockland.ny.us/Highway/hwydocs/Snow%20and%20Ice%20Control%20Policy%202002.pdf.

Skip feels that the policy is a great internal and external communications tool that helps maintain uniformity of service and keep his customers informed. The county receives very few complaints about its snow and ice control services. The commitment to excellence that drove the creation of plan and policy has had important spin-offs in terms of keeping the highway forces up to date in terms of innovative equipment, ground speed-controlled materials application, and level-of-service–appropriate strategies and tactics.

Township of Cranberry, Pennsylvania, Highway Department

Duane McKee is the director of public works for the Township of Cranberry, Pennsylvania. In 2004 the township decided to create a snow and ice control plan and policy that would help in materials management and public communication and acceptance and provide a tool for modernizing operations and equipment. The township went about it in a little different manner. It hired a consultant with significant experience in creating snow and ice control plans to through the process.

The township created a diverse committee including representatives from several stake holding departments, township managers, highway supervisors, and equipment operators to provide input and review material provided by the consultant. As the township had to provide little staff time, the process took only about 2 months from start to final draft.

A separate, but integral, part of Cranberry’s snow and ice plan is a materials management plan. The plan uses situational analysis and identifies all of the business practices employed to minimize environmental pollution. These become the basis for its policy.

Since implementation, Cranberry has used the plan and policy as a primary training document. Duane feels that there has been significant improvement in providing a uniform level of service and a much better understanding of operational policies. This has resulted in fewer

snow and ice service complaints. The plan is available on the township web page (www.twp.cranberry.pa.us/publicworks/SNOWICECONTROL04.pdf).

Using the plan as a roadmap for continuous improvement, Cranberry is phasing in ground speed controllers and truck mounted pavement temperature sensors through new equipment buys. The township installed a “poor man’s” road weather information system (a \$20 bulb thermometer cemented into an area of the parking lot) that provides surrogate pavement temperature information to assist in determining ice control treatments on the roads. Chemical application rates are now designed to reflect current pavement temperature, weather conditions, and the presence or absence of ice–pavement bond.

CREATING A WRITTEN PLAN AND POLICY

The process for creating a written plan and policy is extremely important to the overall success of the effort.

One key element for success is to secure broad-based participation. Representation and input from the following may be helpful in crafting a widely accepted plan:

- Highway agency (probably should lead the process),
- Police agency,
- Fire control agency,
- Emergency medical services and major medical facilities,
- School district,
- Elected legislative body,
- Local transit,
- Major local employers,
- Road and streetside business owners,
- Local automobile clubs,
- Local media,
- Community groups (churches, parent–teacher associations, service groups), and
- At-large customers (road users and roadside property owners)

Form a smaller working committee. It is not practical to have a large working committee comprised of representatives from all of the above groups. Some may have to provide input by only reviewing and commenting on draft documents or attend a few meetings at which they can comment on drafts.

The working committee should have top-to-bottom representation from the highway (lead) agency. Committee members should look for examples of plan and policy documents from neighbor agencies, LTAP centers, the winter planning and organization section of the Salt Institute–LTAP winter maintenance training program, the agencies cited in this article, and internet resources. Much of that will be unnecessary, as most of the topics will be discussed in this paper.

The document should be written to be understood by people outside the highway community. This means that many terms will have to be defined in a clear, concise manner. It is also important that the document be free of composition errors and other mistakes, as people tend

to judge credibility on these items. This means a rigorous edit and review process should be undertaken before publication

Once an agency has crafted a plan it feels will serve the agency and community at large, that plan must be approved by the municipality's legal staff and ultimately by the governing legislative body.

ELEMENTS OF A WRITTEN PLAN AND POLICY DOCUMENT

Introduction

Each plan should have an introductory section that creates a roadmap for readers. This section should contain information that will guide the reader in terms of content, purpose, how the document was created, sources of information that appears in the document, the mission statement for agency snow and ice control operations, and how the agency will use the document. It should also define the action terms that appear in the document. As an example,

Shall and must	=	a required course of action,
Should and recommended	=	a recommended course of action, and
May	=	an optional course of action.

Consider a statement in this section that alerts the reader that due to the finite nature of resources, road conditions during most winter weather events will not be "bare-wet." Also, road conditions immediately after a winter weather event will depend on available resource levels, weather conditions, and the relative success of operations during the event. Severe winter weather events, such as intense snowfall and ice storms, present even more operational challenges, and the restoration of acceptable pavement conditions will be further delayed.

Communication and Cooperation

The section on communication should contain how customers can contact the highway agency to request service or report bad road conditions. It might include telephone numbers, e-mail addresses, and website URLs. Customers should be urged to use restraint in this area, particularly with telephone contacts, as there is likely to be a large volume of calls during winter weather events. If the agency is able to provide weather, road conditions, and treatment progress information, how the public can access that information should be detailed here as well as listing other locations and sources of information about winter maintenance activities.

A section on how customers can help facilitate winter maintenance operations should appear in this section. Items such as parking regulations, snow emergency routes, snow removal operations, tire and chain requirements, abandoned vehicles, and generally not driving during events should appear here.

Another section on how customers can help by keeping trash cans, basketball devices, large obstacles, snow forts, and fencing away from the road. Removing snow from and around hydrants by residents can also be helpful. A reminder that it is illegal to relocate snow into the road should also appear here (this applies to both residential and commercial snowplowing–

blowing–shoveling operations). A copy of the applicable section of state or provincial law should be placed in the appendix.

This is a good location for safety tips about removing and storing snow from driveways and walkways, and general winter safety driving and preparedness information. A section on how the agency will deal with plow damage to mailboxes, turf, and other features should also appear here.

This section is a good location for a multiagency organizational and communications directory as it relates to snow and ice control and other emergency situations.

A listing of the roads within the political subdivision that are not maintained by the agency is always helpful. Here contact information for the responsible maintenance agency should also be provided.

Public relations and media information should be included here. This would include

- Designated spokesperson(s),
- Schedule and content guidance for press releases and newsletters,
- Guidelines for interviews with media, and
- A listing of media forums utilized by the agency.

Agency communications options and procedures should be included in this section. These may include

- Radio communications procedures and protocols,
- Phone and cell phone options,
- Pagers,
- Automated vehicle location (AVL) options and procedures, and
- Dispatcher responsibilities, protocols and procedures.

Level of Service

The section on level of service describes what customers can expect in snow and ice service.

In addition to providing customer expectations, it will be the standard of accountability in the event of slippery roads and related litigation. Common descriptors include

- When treatments are supposed to begin relative to the beginning of a winter weather event;
- Road conditions at various points in time, during and after a winter weather events;
- The level of effort that will be provided for various predicted storm conditions;
- A priority classification of the entire road system (A, B, C; 1, 2, 3; red, yellow, blue, etc.), and the respective level of service assignments;
 - Treatment timing and sequence (priorities) for various storm conditions by time of day and day of week;
 - The time(s) service will be diminished or not provided; and
 - When cleanup operations will begin and what is involved.

It is important for the agency and its customers to realize that available resources dictate the level of service that can be provided. Although there may be political pressure to put a happy face on the service capabilities, it is wise to state only what can actually be provided. Candid statements about not being able to provide the goal level of service during unusually severe and long duration events and other circumstances that may diminish the capability of the work force are a good idea.

Define how level of service is determined. A good way to do this is to establish a “design storm” intensity and duration that may be exceeded about 10% of the time in any given year (the 90th percentile storm) for your area. This will vary considerably depending on location, but 1 in. of snow per hour for a period of 12 h may be a good starting point. Once this is established, use treatment cycle time capability (based on the availability of people and equipment) and the type of treatment capability (solid chemicals, abrasives/chemical mixtures, liquid chemicals, plow only, etc.) to determine how you will describe level of service. Here you can cite the other factors that interact to impact cycle time and routing decisions. These include

- Higher volume and slow traffic moving roads;
- Critical locations:
 - Hills,
 - Curves,
 - Intersections,
 - School bus routes,
 - Transit routes,
 - Emergency services considerations,
 - High snow and ice accident locations and other problematic areas,
 - Business routes,
 - Snow emergency routes,
 - Shift changes for major employers in the area,
 - Churches,
 - Recreational areas; and
- Other situations unique to the local community.

Planning

This section is primarily to provide a blueprint for the agency to conduct the year-around activities that relate to snow and ice control. A good approach is to use the seasons of the calendar year to describe agency activities that should be accomplished in a timely manner, in those time frames.

- Spring activities:
 - Review equipment breakdown and storage;
 - Inventory materials;
 - Inspect highways;
 - Clean winter materials;
 - Repair damage;
 - Analyze winter data;

- Review specific route problems (drainage, manhole covers, obstructions of all types, safety issues, etc.);
 - Review the effectiveness of operational procedures;
 - Review the effectiveness of materials and materials supply;
 - Review the effectiveness of personnel and staffing policies;
 - Review equipment performance and maintenance activities;
 - Review contract, interagency, and intermunicipality cooperative performance;
 - Review the performance of weather service providers and sources of weather information;
 - Review media relations, customer complaints, and customer cooperation; and
 - Solicit feedback from customers and others on the past winter service performance.
- Summer action items:
 - Order and bid materials and equipment;
 - Improve drainage;
 - Remediate obstacle;
 - Adjust drainage structure;
 - Improve high snow and ice accident areas;
 - Acquire necessary personnel and equipment;
 - Train new operators and staff; and
 - Remediate blowing and drifting snow areas.
- Fall activities items:
 - Finalize all cooperative and contract agreements for snow and ice equipment and services;
 - Make sure weather information and other information systems are fully functional;
 - Start sequentially bringing snow and ice equipment on line;
 - Make necessary changes to plan and policy document;
 - Commit necessary operational and other changes to writing (update the written snow and ice control plan and policy document);
 - Refresher training for seasoned operators and staff and continuing training for new operators and staff;
 - Snow and ice meetings with union(s);
 - Calibrate materials spreaders;
 - Mark obstacles (in pavement, adjacent to road, and overhead);
 - Do “dry” and “wet” runs;
 - Trim overhanging trees;
 - Install snow fence;
 - Mark drainage structures;
 - Coordinate meetings with all involved agencies; and
 - Establish and reestablish contact with media and other information outlets.
- Winter activities:
 - Get psychologically, physically, and operationally prepared for the first and succeeding storms (whenever they arrive);
 - Review performance after each storm and make adjustments as necessary;
 - Maintain materials inventory control; and

- Perform timely safety restoration and cleanup operations after each storm.
- Year-round continuous improvement activities. This section is a good location to include the continuous improvement activities that occur throughout the year. These would include: poststorm meetings, postseason meetings, preseason meetings, various training forums, various committee activities, suggestion–innovation–improvement programs, and “living document” provisions for the plan and policy document.

Recordkeeping

A basic recordkeeping system for snow and ice control operations is a very valuable asset. It has a number of benefits including being a powerful tool for use in

- Defense against frivolous tort claims and other allegations,
- Development of budget request and defining impacts of budget reductions,
- Measurement of the efficiency and effectiveness of agency operations, and
- Measurement of the outcome of improvement efforts.

Here the agency should define the essential content or provide appended examples of: operator reports or trip tickets, supervisor reports, equipment operation, and maintenance reports and management reports.

Risk Management

In this section the agency should describe activities and programs that relate to snow and ice risk management. These may include

- Insurance or self-insurance status;
- Safety training programs;
- Programs to identify and remediate high accident locations;
- Weather and road condition information systems (internal and for public distribution);
- Accident investigation, documentation, and reporting procedures;
- Training on agency policy and procedure;
- Training on how to create and maintain records;
- Environmental risk management (details are covered in the “materials management plan,” later in this paper);
- Actions necessary to warn the public of hazardous conditions; and
- Documentation of all operational problems encountered during snow and ice operations, and the actions taken to address those problems.

Operations

Your snow and ice control plan and policy will only be so many words unless you include a section on the nuts and bolts of the plan in terms of operations. This section should identify the strategies and tactics employed by the agency, their background, and rational and specific areas and times they will be utilized. This should be specific and detailed, as it will be a basis for

training agency personnel. Here, a clear definition of fundamental snow and ice control terms should be provided, or reference provided for items such as

- Anti-icing,
- Deicing,
- Temporary friction improvement ,
- Prewetting,
- Pretreating,
- Material spread pattern,
- Material discharge rate,
- Material application rate,
- Ice control chemicals,
- Chemical form,
- Gradation or grain size distribution,
- Solution,
- Chemical concentration,
- Chemical dilution,
- Eutectic temperature,
- Eutectic concentration,
- Endothermic,
- Exothermic,
- Hygroscopic,
- Abrasives,
- Mixed abrasives,
- One-way plow,
- Reversible plow,
- Wing plow,
- V plow,
- Underbody plow,
- Plow angle of attack,
- Plow rake angle,
- Minimum depth of snow that can be plowed,
- Snowplowing,
- Tandem plowing,
- Close echelon plowing,
- Benching or shelving,
- Windrow of plowed snow,
- Snow removal, and
- Other locally defined terms and procedures.

A more complete list (glossary) and associated definitions for most terms that appear in this paper that is suitable for placing in the body of the plan and policy document or in an appendix can be found at www.saltinstitute.org/snowfighting/glossary.html.

Specific Treatment Guidelines

This section provides the specific guidance for all snow and ice control operations. Before designing individual treatments are described, a set of definitions for common terms that relate to pavement and weather conditions should be provided.

- Pavement condition terms:
 - Dry,
 - Damp,
 - Wet,
 - Slush,
 - Loose snow,
 - Packed snow,
 - Frost,
 - Thin ice, and
 - Thick ice.
- Weather (precipitation) condition terms:
 - None,
 - Light rain,
 - Moderate rain,
 - Heavy rain,
 - Freezing rain,
 - Sleet (ice pellets),
 - Light sleet,
 - Moderate sleet,
 - Heavy sleet,
 - Light snow,
 - Moderate snow,
 - Heavy snow, and
 - Blowing snow.
- Treatment design process. This section should define the weather and other information resources utilized by the agency when making treatment decisions. It should also provide definition, significance, and impact of the presence and magnitude of the treatment design factors including
 - Ice–pavement bond;
 - Pavement temperature and trend;
 - Solar radiation or sunshine;
 - Clear night sky radiation;
 - Geothermal effects;
 - Air temperature and wind;
 - Residual snow or ice on the pavement;
 - Type, intensity, and trend of precipitation event;
 - Treatment cycle time;
 - Traffic volume, speed, and timing;
 - Chemical type; and
 - Chemical form.

The analysis of items immediately above should be summarized into an application type and rate tables for the various pavement, weather, traffic, and operating conditions.

Snowplowing Guidelines

This section should include specific procedures and requirements for

- Plowing speed;
- Snow cast;
- Tandem and close echelon plowing;
- Plow angles for various conditions;
- Managing windrows;
- Various lane configurations (passing, turning, deceleration–acceleration);
- Intersections and ramps;
- Crossovers;
- Cul-de-sacs, dead-ends, and alleys;
- Roundabouts;
- Safety appurtenances;
- Railroad grade crossings;
- Shoulders; and
- Benching and shelving.

Materials Spreading Procedures

This section should include specific requirements for placing the ice control material on the highway. Typical items include

- Spreading speed;
- Spread pattern for various conditions and materials;
- Banked curves;
- Hills, curves, and intersections;
- Banked curves and bridges;
- Placement of material in lane(s);
- Parking areas and walkways;
- Bridges and other potentially cold spots;
- Blizzard treatment;
- Thick ice (heavy freezing rain) treatment;
- Thin ice (frost and black ice) treatment;
- Snow pack treatment;
- Railroad grade crossings; and
- Blow-over and drifting areas.

Poststorm Cleanup and Safety Restoration Procedures

This section should contain, with specific location detail, the items of work and when they are to be performed. These items may be included:

- Shoulder plowing;
- Railroad grade crossings;
- Warrants and locations for hauling snow;
- Procedures for loading, hauling, and disposing snow;
- Achieving and maintaining satisfactory pavement surface conditions;
- Clearing sight distance problems;
- Pushing back and benching or shelving;
- Maintaining problematic areas;
- Drainage restoration;
- Clearing bridges;
- Clearing safety appurtenances as necessary;
- Clearing drifted areas;
- Clearing sidewalks;
- Clearing hydrants;
- Clearing crosswalks, islands, and raised medians;
- Clearing traffic calming features; and
- Clearing signs and signals.

Passive Snow Control

This section should contain the locations and type of passive snow control features employed and their maintenance requirements. It should also contain recommendations for design and reconstruction design options that minimize drifting and blowovers.

Personnel or Personnel Management

This section should contain details on all personnel rules and policies that relate to snow and ice control operations. Items that typically would fall into this category include

- Training requirements, forums, and certifications;
- Call-in procedures, incentives and requirements;
- Overtime, shifts, and scheduling;
- Hours of continuous duty limitations;
- Union contract requirements;
- Temporary and reassigned personnel;
- Contracted personnel;
- Fitness for duty—requirements and cites;
- Relevant portions of union agreement;
- Interaction with the public;
- Family readiness; and

- Procedures for managing hired, reassigned, and cooperative personnel.

Equipment Management

This section should contain the nuts and bolts of managing the snow and ice control equipment fleet. This may be further broken down into the agency equipment and other equipment.

Agency Equipment

This should contain the relevant policies and procedures associated with equipment owned or leased by the agency. These may include

- Inventory requirements (parts, required numbers of each type of equipment, and any “spare” equipment allowances),
- Routine inspection procedures,
- Safe operating criteria for each type of equipment (operational),
- Criteria for “downing” or determining a piece of equipment is not roadworthy or safe to operate,
- Maintenance schedule for each type of equipment,
- Calibration procedures for the various materials distribution systems,
- Fueling procedures,
- Personnel authority to perform various types of maintenance and repairs, and
- Procedures and warrants for outsourced repairs and maintenance.

Outsourced, Cooperative, or “Borrowed” Equipment

Everything necessary to acquire and manage other than agency equipment should appear here. Items may include

- Ownership and amount of equipment,
- Activation procedure,
- Contract requirements,
- Determination of priorities,
- Work management procedures (if operator comes with equipment), and
- Accounting and required paperwork.

Emergency Operations

If the agency has a separate emergency operation manual, relevant portions may be incorporated into the plan and policy document at this point. If not, an emergency operations plan should be included here. Critical information to be provided includes

- Contact information for key functions in local, state and federal government, utilities, and emergency aid providers;
- Road and bridge closure plans;

- Detours and emergency evacuation routes and plans for every possible scenario;
- Potential sources of help and what each can provide;
- Maps showing water level at various flood stages;
- Sources of weather information;
- Shelter information;
- Sources of emergency provisions;
- Alert and public information systems;
- Reporting procedures; and
- Emergency fuel procurement.

Materials Management Plan

It is crucial to include a comprehensive materials management plan, within the framework of the agency snow and ice control plan. This will clearly demonstrate that the agency is doing a credible job of planning and executing operations in a way that will have the least possible environmental impact. One of the best sources of information on this topic is found on the Transportation Association of Canada's web page: <http://www.tac-atc.ca/english/information/services/readingroom.cfm#syntheses>.

Policy Statement

The first order of business is to state clearly, in a policy statement, the agency's policy, objectives, and commitment to minimizing environmental impacts and taking reasonable actions to actually reduce environmental loadings. The statement should emphasize that highway safety is the first priority in the agency's snow and ice control operations.

Situational Analysis

Here the agency identifies the potential sources of negative environmental impact associated with snow and ice control operations and defines the locations of areas that are known, or may be, environmentally sensitive to aspects of winter maintenance operations.

- Materials:
 - Sand,
 - Solid ice control chemicals, and
 - Liquid ice control chemicals.
- Material storage and work locations:
 - Stockpiles,
 - Drainage,
 - Housekeeping,
 - Loading,
 - Wash water, and
 - Equipment fluids.
- Potentially sensitive areas associated with on-road usage:
 - Groundwater recharge areas,
 - Vulnerable water tables,

- Drinking water supplies,
- Sensitive vegetation,
- Sensitive water bodies,
- Sensitive agriculture areas,
- Sensitive nonplant species, and
- Other (locally defined).
- Disposal sites:
 - Snow and
 - Abrasives.

Planned Approach

In this section, the proposed control measures for dealing with each of the items in the Situational analysis should be described. These may include

- Equipment calibration,
- Prewetting to make solid chemicals more effective,
- Ground speed control of all materials dispensed,
- Designing individual material treatments in response to weather and road conditions of the moment and near future, and
- Spread pattern control.

Training Activities

The various training requirements and activities in support of the agency materials management program, for agency and hired forces, should be described here.

Monitoring, Recordkeeping, Reporting, Analysis, and Agency Action

Here the systematic process for assuring the materials management program is working as intended should be described in detail.

Appended Information

This section should contain a listing and location of the various appended information that appears at the end of the document. These may include

- Beat or route maps,
- Personnel policy documents,
- Relevant portions of union agreements,
- Personnel rosters including area(s) of responsibility,
- Equipment inventory by type and year class,
- A listing and locations and maps of parking sites for use during storms and cleanup operations,
- Snow storage and disposal locations,
- Maps showing emergency snow routes and level of service classifications,

- Locations of emergency shelters,
- Copies of any applicable local laws or ordinances, and
- Copies of applicable portions of state or provincial highway law, insurance law, and vehicle and traffic law.

FINAL STATEMENT

The list of possible topics for inclusion in municipal snow and ice control plans provided in this paper is large and probably incomplete. Realistically, it is not expected that every snow and ice control plan will contain all of the material listed. However, it is a good idea for an agency to at least consider all of the topics.

APPLICATION OF WEATHER INFORMATION IN TRANSPORTATION AGENCIES

Follow-Up Study of Winter Standard as a Research and Development Project

TORGEIR VAA

SINTEF Roads and Transport

IVAR HOL

Norwegian Public Roads Administration

Norway is divided into 103 winter maintenance contracts—first quarter on bid in 2003 and the last quarter on bid in 2006. One of the consequences of the competitive tendering is a decrease in the research and development (R&D) projects involving the contractors. This is why the Norwegian Public Roads Administration has introduced challenging measures to maintain a required level of research in winter maintenance. In one of the contracts starting in autumn 2006, there has been set aside US\$100,000 per year in the 7-year contract period to stimulate research projects. This amount of money is meant to be used for investment in equipment and to cover extra costs for the contractor and road keeper. The project consists of a main project with focus on a follow-up study of the winter standard on the most important road in the contract area. Two other subprojects planned for are (a) sanding under difficult conditions with different gradation of the sand to investigate the importance of the grain size on the friction improvement and duration of a sanding action and (b) the relationship between pavement condition and amount of winter maintenance actions. This paper describes the background and content of the main project and the two subprojects and also some preliminary results. The results from the project so far are positive from both a professional and an organizational point of view. R&D within the area of winter maintenance is already included in several of the contracts renewed in 2007.

Norway is divided into 103 winter maintenance contracts—first quarter on bid in 2003 and last quarter on bid in 2006. The contracts are performance based (friction, snow depth, etc.).

One of the consequences of the competitive tendering is a decrease in the research and development (R&D) projects involving the contractors. This is why the Norwegian Public Roads Administration has introduced challenging measures to maintain a required level of research in the area of winter maintenance. In Contract 1503, Indre Romsdal southwest of Trondheim (Figure 1), there has been set aside US\$100,000 per year in the 7-year contract period to stimulate research projects. This contract started in autumn 2006.

The main project focuses on a follow-up study of the winter standard on E136, which is a trunk road and the most important road in the contract area (Figure 2). The main reasons for the choice of contract and the road section in the follow-up study are

- The area is very exposed to snow avalanches,
- The area is an important route for trailer trucks and is of high national importance,
- There have been many complaints from the public, and
- In addition to the functional requirements in the contract, there are also special demands regarding the readiness and equipment.

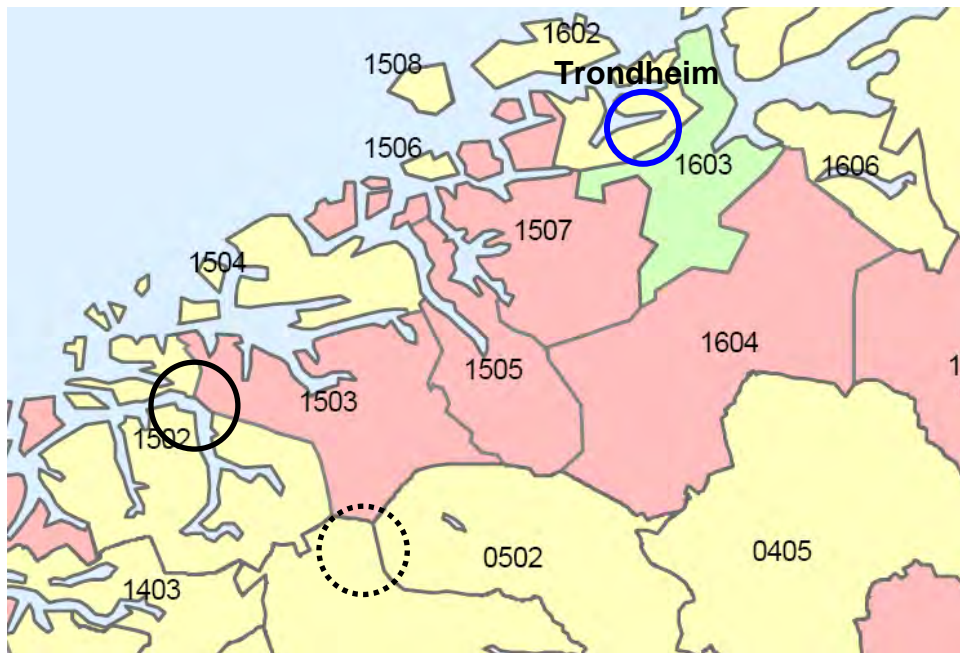

FIGURE 1 Contracts 1503 and 0502 are included in the study area.

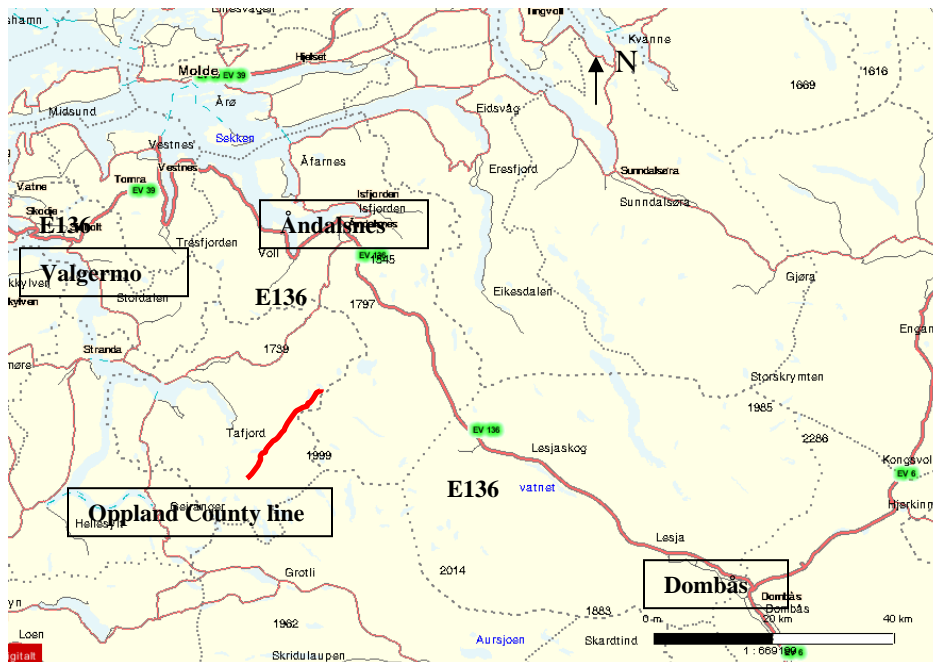

FIGURE 2 Map showing E136 in the follow-up study.

The annual average daily traffic (AADT) on E136 in Romsdalen is 1,500, with winter traffic slightly above 1,000 vehicles per day. The share of trailer trucks is approximately 40%. The road standard varies a lot, and the road width is narrow compared with the traffic volume and proportion of trucks. The road is also twisting and has steep hills with a mean gradient of 6% on the last part of the way from Åndalsnes to the county line.

GOAL

The goal of the project is to improve the traffic safety and trafficability with correct use of resources and it has been decided to focus on documenting the winter standard by frequent follow up of the road conditions. The purpose with this is to

- Give a good basis for the contractor to carry out the correct measures to the correct time,
- Give good and updated information to the public regarding the driving conditions through the winter, and
- Supply the road keeper with good documentation of the winter standard and driving conditions on the road.

ORGANIZATION OF THE PROJECT AND EXPECTED RESULTS

The follow-up study is organized as a joint effort between the contractor and road keeper, and it is expected that the collaboration in the project will initiate other important R&D projects. The project is expected to give benefit in the short term:

- Better basis for decisions and faster reaction time for execution of winter operations will result in better driving conditions and increased traffic safety and trafficability on the road network and
- Better information will be of service to the road users and make it possible for the transport industry to plan their deliveries in a better way.

Long-term systematic documentation and analysis of the actual winter standard will provide knowledge that can be used as a basis for improvement of routines and methods both locally and in general:

- Overview of difficult road sections and places demanding extra effort;
- Overview of time and periods when, on the basis of experience, difficult driving conditions can be expected;
- Overview of how different weather conditions influence on driving conditions and the need for actions;
- Better basis to assess the effect of different methods, equipment, and materials; and
- Better basis to evaluate standard requirements and contract descriptions.

In addition the area covered by the project has been chosen to test new requirements developed as a part of an ongoing revision of the Norwegian winter standard (Handbook 111). The following questions are addressed:

- What is the friction when measures in form of plowing and sanding and salting are carried out?
- What is the friction when the driving conditions are difficult?
- How do the friction conditions vary throughout the whole road section?
- Is it possible to measure direct impact on the driving speed when actions are carried out?
- How much precipitation as snow is necessary to reduce the trafficability to such extent that the traffic flow is reduced?

PROJECT DESCRIPTION

Expansion of the Project and Maintenance Strategies

In autumn 2007 the road in the follow-up study was extended to Dombås in Oppland County. The reason for the extension of the road section was several aspects adding value to the project:

- The project now covers two regions;
- More winter conditions are expected in Oppland County, the registration season will thereby be prolonged, and more data will be obtained;
- Two different contractors are involved in the project;
- The follow-up study covers contracts with different terms of settlement—one with fixed price and one with variable winter costs depending on the severity of the winter; and
- The road section in the follow-up study includes three different winter maintenance strategies.

The friction requirements for different strategies are summarized in [Table 1](#) and [Table 2](#). For comparison the requirements for bare road strategy is similar to the almost bare road strategy except that the whole roadway shall be bare within the same time limits and anti-icing shall be done when friction is expected below 0.40.

The road section Oppland County line—Valgermo is operated according to winter road strategy with a shorter section of 12 km operated according to almost bare road strategy, that is, salt is being used when the conditions are appropriate for using salt.

The road section Oppland County line–Dombås is operated according to a strategy with so-called active salting. The design of this strategy is that snow or ice cover is acceptable with friction requirements according to winter road strategy. The contractors are allowed to use salt in their daily operations if the use of salt makes it easier to meet the friction requirements. This strategy is being used on trunk roads and other roads with high traffic where it is difficult to achieve the friction requirements by the use of sand or salt-blended sand.

TABLE 1 Friction Requirements, Winter Roads Strategy

Class of Road	AADT	Local Sanding		Continuous Sanding	
		Start At	Finished Within	Start At	Finished Within
Trunk roads		$\mu < 0.30$	1 h	$\mu < 0.20$	2 h
All other roads	> 1,500	$\mu < 0.25$	1 h	$\mu < 0.20$	2 h
	501–1,500	$\mu < 0.25$	2 h	$\mu < 0.15$	3 h
	0–500	$\mu < 0.20$	2 h	$\mu < 0.15$	4 h

NOTE: μ is the friction factor before spreading is started.

TABLE 2 Friction Requirements, Almost Bare Roads Strategy

Tasks	Triggering Criteria and Maximum Time for Action in Regard to Different AADT		
	< 3,000	3,001–5,000	> 5,000
Anti-icing	If expected friction value < 0.30	If expected friction value < 0.30	If expected friction value < 0.30
Deicing after snowfall: bare in tracks before	6 h	4 h	2 h

The different strategies for friction measures give the follow-up study an interesting dimension regarding both the actual standard gained and the amount of actions carried through.

Data Recording

A registration vehicle is provided for the follow-up study. The main instrument on the vehicle is a friction device of the type Traction Watcher One (TWO), which is a continuous measuring device with fixed slip test wheel (Figure 3). TWO is mounted on a tow bar. The test wheel is equipped with a standardized friction measurement tire according to ASTM E-520 (grooved tread) with 8 in. diameter. The test wheel is normally positioned in the left wheel track.

Data are transferred to a laptop mounted on the dash, and there is a new recording every second. The friction value recorded is the mean value of the readings at the last second (100 readings per second). Data are stored in a database.

The TWO friction device has been modified to meet the needs in the project and in autumn 2007 was ready in a new version. One of the new functionalities is that a new measuring mode is introduced and allows for three different ways of doing the measurements:

- Normal mode. Friction measurements with standard 60 kg ground pressure.
- Inspection mode. When the coefficient of friction exceeds a set value, e.g., 0.60 over a distance of 100 m the ground pressure is automatically lowered to 30 kg, and the ground pressure is raised again to 60 kg when the coefficient of friction falls below a set limit over a distance of 100 m.
- Spot mode. Friction measurements are made with 60 kg ground pressure on a 70-m long road section at fixed intervals. The operator chooses the measuring intervals between 1 and 5 km. All data except for the friction value are logged continuously.



FIGURE 3 TWO friction measuring device.

On days with winter conditions, up to three trips per day are made in both directions in the hours between 4 a.m. to 10 p.m. Other data are also recorded including the extent of plowing and salting–sanding, weather conditions, and traffic flow and speed. The follow-up study includes the following routines (some of the routines are new in the autumn 2007):

- Friction measurements with TWO friction measuring device;
- Air temperature, road surface temperature, and relative humidity;
- Calculation of dew point;
- Pictures in fixed points triggered by position registered by use of a Global Positioning System;
- Road weather data from road weather information systems (RWIS) stations;
- Registration of car rescue actions by use of pocket PC (new routine autumn 2007);
- All measures carried out by the contractor registered by use of automatic data collection system;
- Programmable pocket PC used to register additional information about the road conditions;
- Drivers on buses and trucks filling out a form to have their opinion on the driving conditions; and
- Automatic registration of driving speed by recognition of vehicles using piezoelectric cables to register number of axles and weight (new routine autumn 2007).

In addition to the follow-up study, it can also be mentioned that two other subprojects are planned:

- Sanding under difficult conditions with different gradation of the sand to investigate the importance of the grain size on the friction improvement and duration of a sanding action, and
- The relationship between pavement condition and amount of winter maintenance actions.

There will be a preliminary report with the results from these two subprojects after the winter season 2007–2008.

RESULTS

Amount of Winter Operations

Figure 4 shows the amount of plowing and consumption of salt and sand on trunk roads in the two contract areas in the winter season 2006–2007.

Both the extent of plowing and use of sand indicate that there is a major difference between the two contract areas. There can be several explanations to this: difference in the climate, difference in the road geometry, difference in the interpretation of the contract regulations, and difference in the terms of settlement. It is too early to draw conclusions on the differences in the total winter maintenance effort in the two contract areas, but there are some indications that the payment system can be a factor influencing the contractors' input of labor (Figure 5).

From Figure 5 one can see that for the salting costs and the sanding costs both the reported variable costs in Contract 1503 are substantially higher than anticipated costs based on empirical data. The reason for this will be further investigated in the coming winter seasons and also against controlled data for Contract 0502.

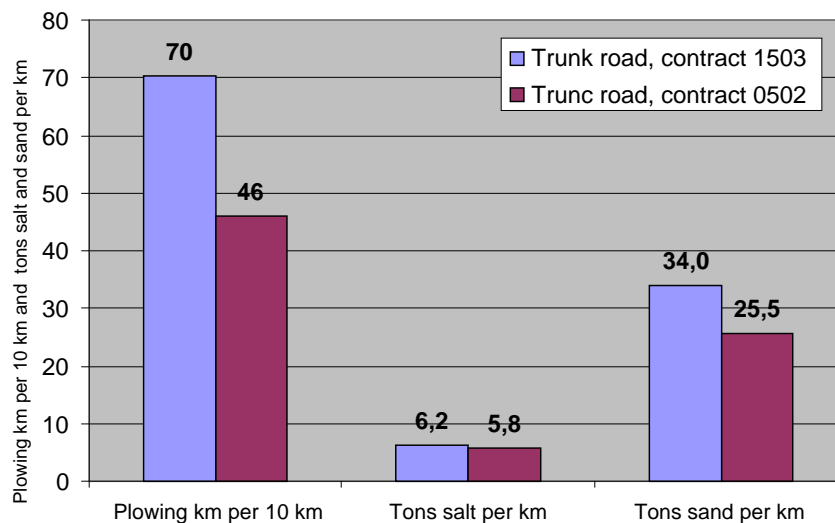

FIGURE 4 Amount of plowing and consumption of salt and sand for the winter season 2006–2007.

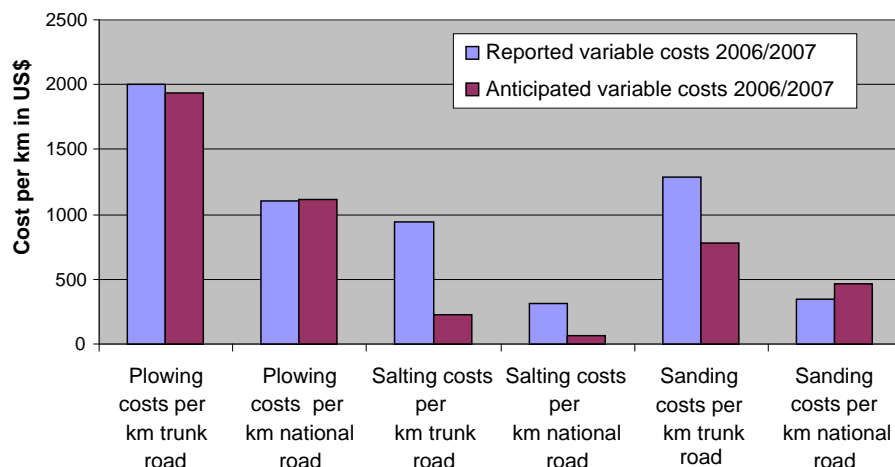

FIGURE 5 Reported and anticipated variable costs on trunk roads in Contract 1503.

Driving Conditions Reported by Bus and Truck Drivers

In the winter season 2006–2007 a total of seven drivers on buses and trucks participated in the reporting activities to give their subjective view on the driving conditions. The main reporting period was from January 8 to March 26, 2007. The drivers were asked to fill out a form and note travel time and their view on the driving conditions and need for friction improvement actions on the two road sections: Valgermo–Åndalsnes and Åndalsnes–Oppland County line. The following alternatives were listed in the form:

- Driving conditions: very good, good, slightly difficult, very difficult or
- Need for friction improvement actions: yes, no, partly.

Figure 6 and Figure 7 show the statistics based on the reported driving conditions and the drivers' judgment of the need for salting and sanding for the road sections Valgermo–Åndalsnes and Åndalsnes–Oppland County, respectively. It is a bit surprising that the driving conditions are reported to be poorer on the road section Valgermo–Åndalsnes than on Åndalsnes–Oppland County since the road eastward from Åndalsnes traditionally is most problematic. One reason for this can be that the contractor gave higher priority to this part of the road since most of the complaints in earlier winter seasons were related to the road section Åndalsnes–Oppland County. See also the comments in Figure 12.

Another interesting aspect is whether there is a logical connection between the drivers claim for friction improvement actions and the reported driving conditions. Table 3 shows that there is not such a clear connection. More than half of the need for partial actions is claimed while the driving condition is reported to be good.

Figure 8 shows the calculated mean travel time under different reported driving conditions. The results presented in Figure 8 show that the subjective reporting of the driving conditions is not fully consistent with the travel time noted. For both road sections the maximal travel time is noted when the driving conditions are reported to be best. The data set is, however,

Reported driving conditions, Valgermo - Åndalsnes

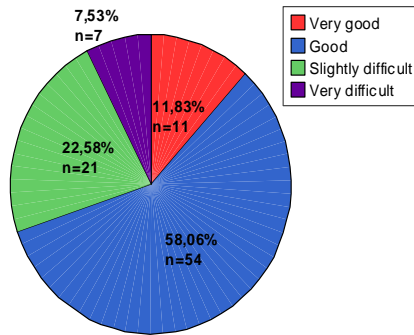

Need for salting/sanding actions, Valgermo - Åndalsnes

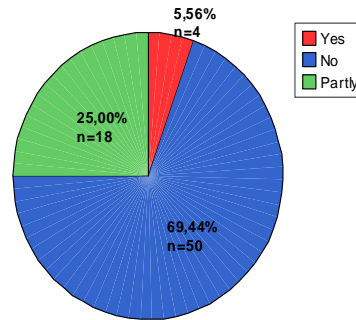
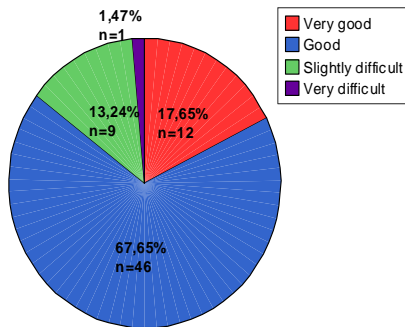

FIGURE 6 Driving conditions January 8–March 26, 2007, reported by bus and truck drivers, Valgermo–Åndalsnes.

Reported driving cond., Åndalsnes - Oppland County



Need for salting/sanding, Åndalsnes - Oppland County

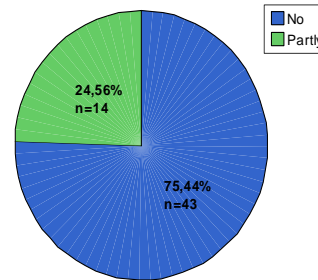

FIGURE 7 Driving conditions January 8–March 26, 2007, reported by bus and truck drivers, Åndalsnes–Oppland County.

TABLE 3 Cross-Tabulation Between Driving Conditions and Need for Salting–Sanding

Need for Salting–Sanding	Valgermo–Åndalsnes				Åndalsnes–Oppland			
	Yes	No	Partly	Total	Yes	No	Partly	Total
Driving conditions								
Very good	0	10	0	10	0	10	0	10
Good	0	31	10	41	0	26	8	34
Slightly difficult	1	6	7	14	0	2	4	6
Very difficult	3	2	0	5	0	0	1	1
Total	4	49	17	70	0	38	13	51

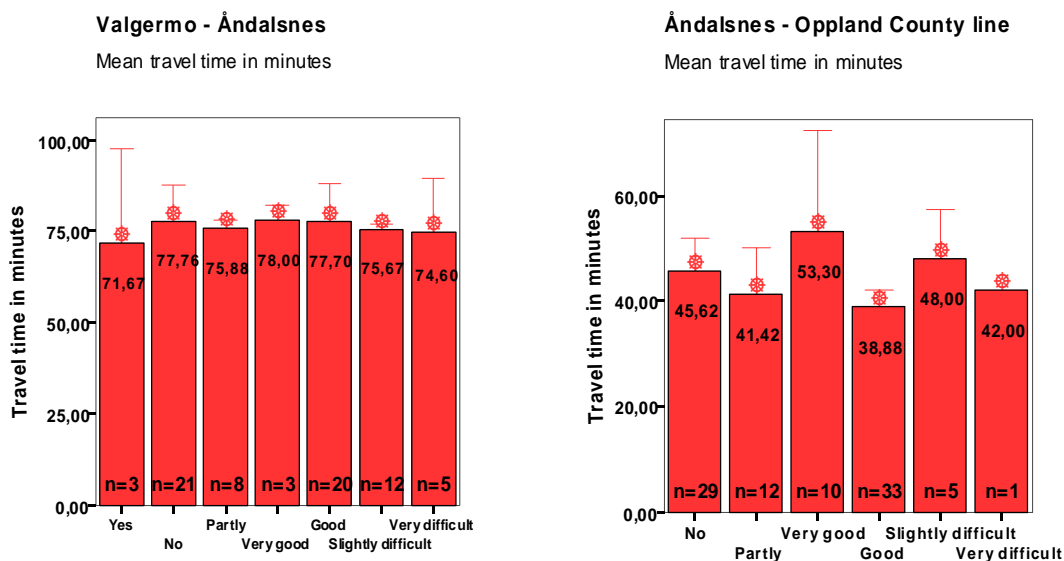

FIGURE 8 Mean travel time during different reported driving conditions.

too limited to get significant results. This supports the need for more objective data and also to increase the amount of data to be able to analyze what factors influence the most on the travel time for heavy vehicles. This is why a new method for registration of travel times was introduced in autumn 2007.

Friction Measurements

Data from the first winter season showed that some days there could be great variations in the driving conditions between different road sections. Some examples are shown in the following figures. Figure 9 shows RWIS data during a snowfall in February 2007, and Figure 10 and Figure 11 show friction measurements made the same day at 08:36 and 9:46 a.m., respectively.

The main idea in the first winter season was to register the variability in driving conditions alongside the road section in the follow up study. Figure 11 shows the results from the friction measurements approximately 60 km west of the section presented in Figure 10. The variation in this case probably was caused by variations in the climate.

Over the registration period January 15 to February 27 (Figure 12), the mean coefficient of friction on four shorter road sections did not vary very much. The only exception was the road section where salt was applied, Number 1 from the Oppland County line to Sæterbø. Up the rise (eastward) the mean coefficient of friction on this part of the road was 0.35 compared with 0.27–0.30 for the other three road sections in Figure 12. Even if the difference is not significant, this can also explain the reports from the bus and truck drivers since road section NR 7 is a mountain pass located between Valgermo and Åndalsnes, where salt was not being used.

The routines for the friction measurements during the winter season 2006–2007 did not allow for more frequent measurements and was not suitable for detailed follow-up of the change

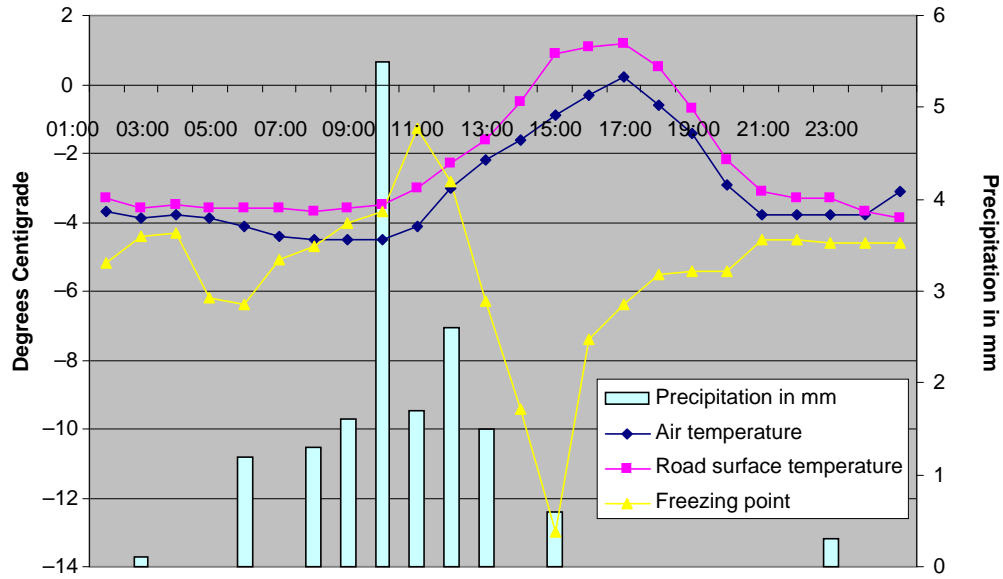

FIGURE 9 Data from Brustuglia RWIS station, February 27, 2007.

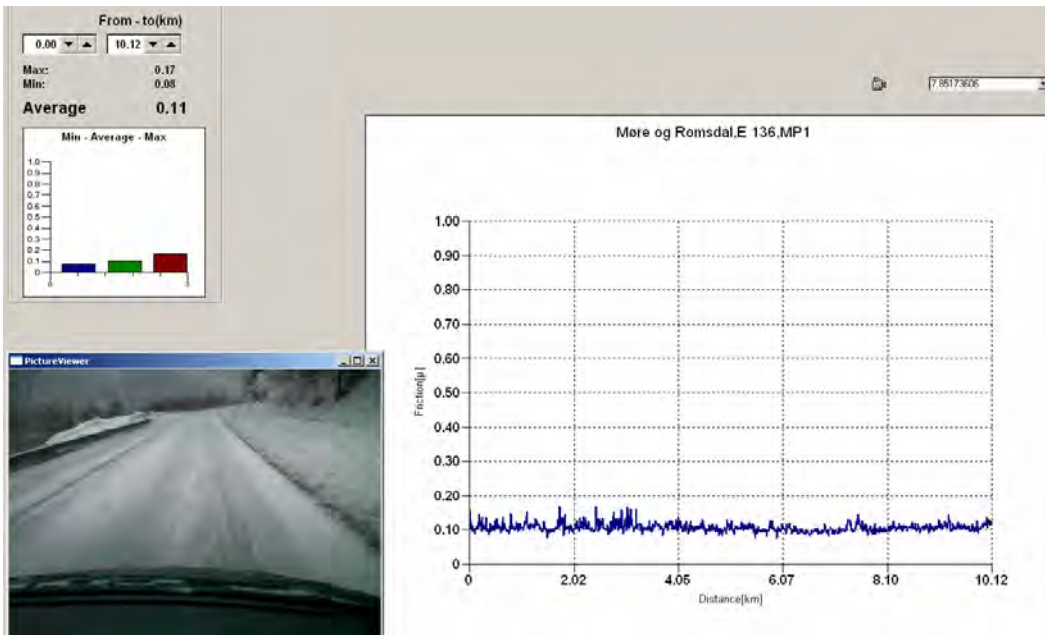

FIGURE 10 Friction measurements past Brustuglia RWIS station, February 27, 2007, 8:36 a.m.

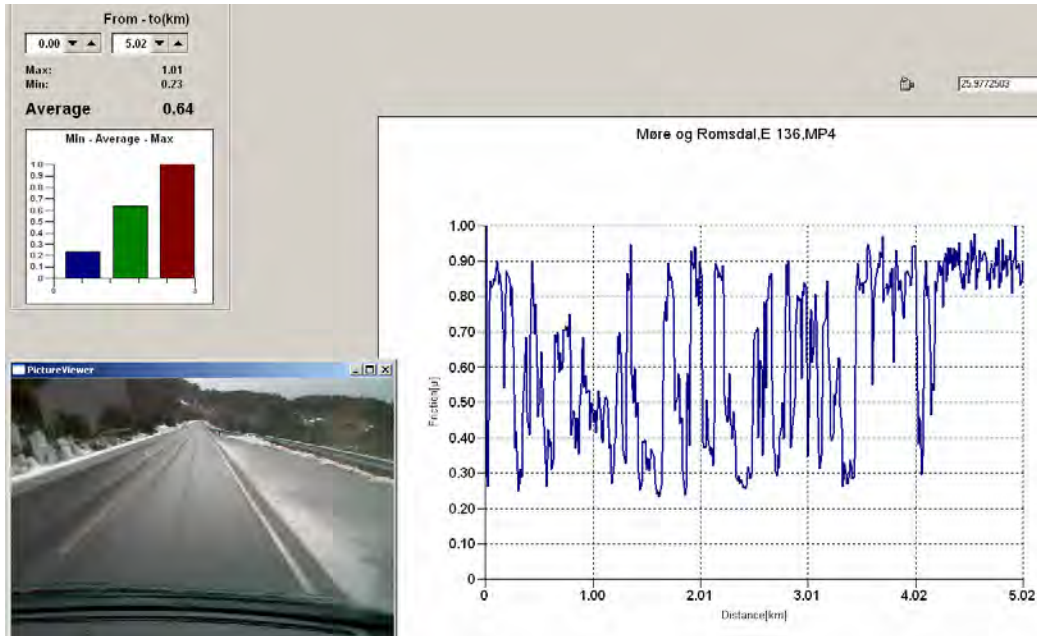

FIGURE 11 Friction measurements 60 km west of Brustuglia RWIS station, February 27, 2007, 9:46 a.m.

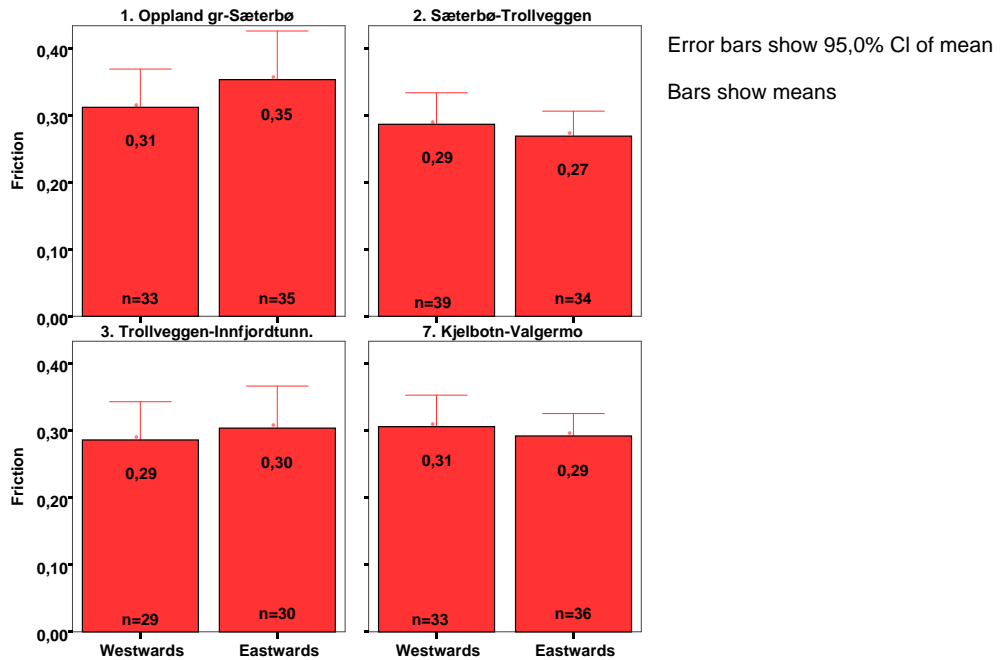

FIGURE 12 Mean coefficient of friction during the winter season 2006–2007 on E136.

in driving conditions on a long road section during a precipitation period. Such studies are, however, planned for the winter season 2007–2008 for periods to concentrate on the measurements on shorter road sections.

Figure 13 illustrates how the road surface changes through snowfall, February 27, 2007, near the RWIS station, and the plan is to cover such situations with more frequent friction measurements in the winter season 2007–2008.



FIGURE 13 Pictures from Brustuglia RWIS station, February 27, 2007, 07:11–12:41 a.m.

CONCLUSIONS

The results from the project so far are positive from both a professional and an organizational point of view. Preliminary results from the winter season 2006–2007 support the main idea behind the project that incorporating R&D in maintenance contracts is of value to both the road keeper and the contractor. The project helps in increasing the general knowledge about factors influencing the driving conditions, the importance of doing the correct actions, and also the benefit of having a system to follow up the standard on winter roads.

ACKNOWLEDGMENTS

Public Roads Administration Midregion has initiated the project and is responsible for the project management together with the Centre for Road and Traffic Technology in Trondheim. The contractor is actively involved in the project.

APPLICATION OF WEATHER INFORMATION IN TRANSPORTATION AGENCIES

Integrating Weather into Transportation Operations

A Utah Department of Transportation Case Study

CHRISTOPHER K. STRONG

XIANMING SHI

Montana State University

Recent years have brought increased awareness of the impacts of weather on surface transportation operations. A variety of approaches to improve the utilization of weather information have emerged, including investments in technologies, such as road weather information systems and decision support systems, and an increasing array of private-sector and public-sector sources of weather information, including emerging initiatives such as *Clarus*. One recent trend, documented in federal studies, is the idea of integrating weather information into transportation operations decisions. This is a promising direction for improving the reliability and safety of the transportation system. The Utah Department of Transportation (UDOT) has taken an innovative step in this direction through the creation of a weather operations program as a part of UDOT. The weather operations program utilizes an in-house meteorologist, augmented by private-sector forecasting support, to provide customized weather information to a variety of users within UDOT, ranging from winter maintenance to construction to operations. A research project was conducted to examine this unique program more closely to see how its services were used by DOT customers to change and improve business practices. The project included surveys of many UDOT maintenance foremen and construction engineers, as well as a quantitative benefit–cost analysis based on data collected regarding winter maintenance activities and outcomes. The results of the research showed that the weather operations program provides significant benefits to UDOT merely from a winter maintenance perspective. There are additional benefits of the weather operations program to other functions within UDOT that, though not quantified in the research project, were clearly indicated. This paper describes the findings of the research project, with the idea of applying it as a case study for consideration by other states. The paper will integrate other recent studies that have explored the question of how weather can support transportation operations and will highlight directions for promising innovations in this direction on the basis of what was learned in the UDOT experience.

Surface transportation in the United States is constantly threatened by the capricious character of weather, as weather “acts through visibility impairments, precipitation, high winds, temperature extremes, vehicle maneuverability, pavement friction, and roadway infrastructure” (1). Adverse weather increases the likelihood of traffic accidents that may result in injuries and fatalities. There are more than 1.5 million weather-related crashes in the United States every year, resulting in 690,000 injuries and 7,400 fatalities (2). The estimated economic cost from weather-related crashes in the United States alone amounts to nearly \$42 billion annually (1). In addition, adverse weather causes traffic delays, estimated at nearly 1 billion person hours per year (3), which degrade the productivity, reliability, and user experience of the surface transportation system.

Improving the quality and accessibility of road and weather information may benefit a wide spectrum of weather data users, including state and municipal departments of transportation (DOTs), public weather forecasting agencies, public weather consumer agencies, private weather information providers, electronic and print media, road users, in-vehicle navigation system

providers, the general public, mass transit, and rail (4). These benefits come not only as information is tailored to specific users but also as it is integrated into the way those users conduct business.

This paper describes an innovative approach for improving the integration of weather information with transportation operations adopted by the Utah Department of Transportation (UDOT). After reviewing the value of weather information and recent efforts to improve the quality and usefulness of weather information, the paper will describe how UDOT's Weather Operations/Road Weather Information System (RWIS) program integrates weather information into the DOT's operations, and the types of benefits that it has provided for its customers.

RECOGNIZING THE VALUE OF WEATHER INFORMATION

The staggering statistics presented in the introduction highlight the challenges posed by weather on the highway system. However, the problem which is revealed by these statistics does not commend its own solution. As long as the surface transportation system operates in exposed environments, it will be subjected to the effects of weather. Therefore, the question arises as to how the adverse effects of weather, including safety and delay, can be mitigated. The question can be answered, in part, from the perspective of maintainers, operators, and the traveling public.

Proactive Winter Maintenance

According to FHWA, winter road maintenance accounts for roughly one-quarter of state DOT maintenance budgets. Each year, state and local agencies spend more than \$2.3 billion on snow and ice control operations (2). These operations are necessary to preserve mobility and safety for the traveling public, for whom the costs of winter weather crashes and delay are much greater than costs borne by road agencies. However, while agencies are under increasing pressure to preserve a high level of service on the roadways, especially to support goods movement, maintenance budgets are often stagnant.

In recent years, transportation agencies across North America have been shifting from reactive strategies to proactive strategies for snow and ice control, such as anti-icing. Compared with traditional methods for snow and ice control (e.g., deicing and sanding), anti-icing leads to decreased applications of chemicals and abrasives, decreased maintenance costs, improved level of service, and lower accident rates (5). Partly attributable to the paradigm shift from reactive to proactive winter maintenance strategies and tactics, state and local maintenance professionals across North America are beginning to realize the importance of high-resolution, customized, area-specific weather forecasts for surface transportation (6,7,8).

Integration of Weather into Transportation Operations

The user costs associated with traffic congestion are also significant, estimated at \$78 billion per year (9), with the vast majority of these costs being borne in urban areas. Most U.S. urban areas have created transportation management centers (TMCs) to assist with management of traffic, focusing on quicker detection and clearance of incidents, traffic control and traveler information strategies. Since an estimated 15% of congestion is due to weather events (10), it is logical that there could be potential value in integrating weather into transportation operations.

A recent FHWA study investigated this question, examining the state of the practice of the integration of weather information into TMCs (11). The study identified five dimensions in which integration can be characterized. The first dimension is operational integration, which includes the ways in which data and information are shared and used, such as to support operational decision making. This integration is supported by four other types of integration: physical integration, technical integration, procedural integration, and institutional integration. While noting some success stories, the report noted that there are several challenges to integrating weather information into TMCs, including a failure to recognize the opportunities for weather integration and a lack of awareness of the value of weather information in traffic operations.

This study has been accompanied by others, including a self-assessment tool to help agencies improve their integration of weather information, and a concept of operations for weather responsive traffic management (12), which are seeking to improve how TMCs and transportation system managers use weather information.

Safety and the Traveling Public

Another way that weather information can provide value is when it is provided directly to the traveler. Surveys of traveler information services have routinely noted that weather information, whether provided through text or camera images, is the most frequently requested type of information (13). Improvements in technology have also allowed for the creation of dynamic warning systems, in which weather sensors are integrated with flashing beacons or other dynamic signing to warn motorists of specific weather phenomena, such as reduced visibility, high winds, or icy pavement (14, 15). These technologies can help motorists prepare for challenging weather conditions that may not be immediately resolvable through maintenance action or operations mitigation.

RECENT IMPROVEMENTS IN WEATHER INFORMATION

The operational and safety effects of weather on the highway system have spawned numerous efforts at improving the quality of weather information in the roadway environment. These have ranged from efforts which focus on improving observations and forecasting to systems designed to make it easier to apply the weather information to the transportation system.

RWIS Program

Many transportation agencies have adopted RWIS as an important weather information tool. RWIS includes the hardware, software, and communications interfaces necessary to collect and transfer field observations from a remote site to a display device at the user's location. RWIS collects data from environmental sensor stations, which include a suite of atmospheric, pavement–subsurface, and water-level sensors (16). They differ from conventional weather stations in that they are always deployed in the immediate highway environment, they often measure conditions on the roadway itself, and they are generally deployed where roadway weather conditions tend to be worst.

While RWIS provides detailed weather information, this is only for specific points along the roadway; information on conditions between these points must be generated from other sources or interpolated. Moreover, significant costs are associated with RWIS networks, not only for initial installation activities but also for on-going maintenance, calibration, communications, and power.

Mesonets

The concept of a mesonet is to integrate weather observations from a variety of sources to improve on the density of weather observations over what may be available through a single source. There have been several successful demonstrations of mesonets to support surface transportation.

rWeather

rWeather is a web-based system that was created and is maintained by the Washington State DOT and the University of Washington to collect real-time and predictive statewide road and weather information and disseminate it to WSDOT maintenance and other decision makers, as well as to the public. rWeather integrates weather data from nearly 400 weather stations throughout the state, offers the data at a single location in a graphic format, and supplements this with forecasts provided by the Northwest Regional Weather Consortium and the University of Washington.

WeatherView

WeatherView is a web-based system maintained by the Iowa DOT to collect real-time and predictive statewide road and weather information and disseminate it to DOT maintenance and other decision makers, as well as to the public. The information is collected from RWIS sensors, airport-based sensors, and regional forecasts provided by a private contractor, as well as contractor-produced bridge frost forecasts.

WeatherShare

The California Department of Transportation's (Caltrans) WeatherShare is a web-based system that features the integration of regional weather and road data and forecasts from multiple sources and agencies. Its focus is on streamlining currently available weather and road data from Caltrans RWIS sites, National Weather Service (NWS) sites, and other sources available in the region into one single source easily accessible by incident responders and potentially the traveling public. Unlike rWeather and WeatherView, it does not provide weather forecasts at this time.

Clarus Initiative

The *Clarus* Initiative is a federal effort that seeks to “develop and demonstrate an integrated surface transportation weather observation data management system, and to establish a partnership to create a nationwide surface transportation weather observing and forecasting system” (17). Such a “system of systems” will “collect, quality control, archive, and disseminate surface transportation weather observations” (17). It is envisioned to improve surface transportation weather forecasting with enhanced data density, quality, and integration. Three multistate demonstrations are currently under way, and grants have been provided for states to integrate their RWIS data into *Clarus*. *Clarus* is similar to the other mesonets in its aggregation of current conditions; however, it does not incorporate forecasts at this time.

FORETELL System

FORETELL refers to a multistate advanced road and weather condition prediction system developed by Castle Rock Consultants. It integrates satellite, radar, and surface observations with RWIS data, using state-of-the-art National Oceanic and Atmospheric Administration–NWS weather models and decision support displays (www.crc-corp.com/projects/archive/Foretell.htm). The service provided by FORETELL includes a 24-h forecast updated four times per day as well as hourly updates known as nowcasts, and pavement condition predictions (7). FORETELL is similar to some mesonets in that it aggregates current and predicted weather information. The application also includes manual road reports, which are input using a sister system, Condition Acquisition and Reporting System. Four states continued to operate FORETELL’s regional forecasting models until the winter of 2006–2007, when they switched to maintenance decision support system (MDSS) modeling approaches, which are described below.

Maintenance Decision Support System

The concept of the MDSS is to use state-of-the-art forecasting techniques based on scientific principles to provide accurate roadway treatment recommendations for winter maintenance personnel. MDSS has been developed as a computer application. It tries to automate many information-gathering and synthesis techniques to support winter maintenance treatment decisions. Several efforts fall under this term. A FHWA effort initiated in 2000 has coordinated work between several national laboratories to develop and enhance a prototype MDSS that can be used on its own or as a foundation in private-sector MDSS applications. A group of state DOTs, led by South Dakota, has worked with a private-sector vendor to develop a MDSS focusing on tactical treatment recommendations. Other private-sector vendors are also marketing products of this type. FHWA is now discussing expanding the MDSS concept to provide weather information for other surface transportation applications, including traffic operations and transit.

Private-Sector Meteorological Services

The private sector has long played a role in tailoring weather forecasts for specific groups of users. Advances in meteorology, telecommunications, and computational programs “have created a situation in which forecasters have more to offer transportation operators and users than

ever before” (18). In a recent survey, winter maintenance professionals said that private-sector forecast services can provide more accurate forecasts (due to the knowledge of microclimates), more timely forecasts, access to a forecaster to help improve forecast quality, advanced warning of storm conditions to assist in storm response, and knowledge of weather parameters that can influence treatment decisions (including storm timing and precipitation amount, type, and rate) (19). Respondents also reported high levels of satisfaction with these services, saying that these can be cost-effective.

CASE STUDY: UDOT WEATHER OPERATIONS PROGRAM

The preceding sections hint at the level of interest and effort being directed toward improving how the transportation system responds to weather. The subject of this paper is UDOT’s Weather Operations/RWIS program, which combines many of these elements into a nationally unique entity.

Beginnings

The program’s origin traces back to when Salt Lake City prepared to host the 2002 Winter Olympic Games. Organizers and transportation agency personnel were aware that the same winter weather that attracted Olympians and spectators could prove challenging for people trying to access event sites. Some of the challenges included the potential for adverse weather to delay or postpone events and to impede access to events because of reduced visibility or high winds (20).

The need to document weather events before and during the Olympics resulted in an expanded number of weather station installations throughout Utah. During the Olympics, a hazardous winter weather potential was produced for the primary transportation corridors twice each day; it included the weather forecast as well as wind, temperature, and precipitation predictions. This report was also produced for the avalanche zones along US-189. The information from these reports along with private-sector customized forecasts assisted UDOT with their winter road maintenance (20). After the Olympics concluded, these efforts developed into a UDOT effort called the Weather Operations/RWIS program.

Structure and Products

Currently, the UDOT Weather Operations/RWIS program assists the DOT operations, maintenance, and construction functions by providing detailed, often customized, area-specific weather forecasts. Established under the UDOT Traffic Management Division, the program has two main components. First, the Weather Operations component features four staff meteorologists stationed in UDOT’s Traffic Operations Center (TOC), providing year-round weather support for winter maintenance, road construction, and rehabilitation projects; TOC operations, avalanche safety, planning, risk management, training, and incident management. With the staffed meteorologists, quality control of weather forecasts is ensured. Weather briefings are conducted in the TOC on a daily basis, involving TOC personnel, area supervisors, and maintenance foremen. In addition, the program provides tailored crew-specific forecasts in a text format for all 82 UDOT maintenance sheds. Another component of the program is the

intelligent transportation systems component, which manages 48 RWIS stations and expert systems such as bridge spray systems, high wind alerts, and fog warnings (21).

As shown in Figure 1, the program provides various services to numerous customers within UDOT. It provides the Office of Central Maintenance with year-round, long-term weather forecasts that are mainly used for planning in terms of materials (storage and purchasing), staffing, and equipment. It provides construction engineers and contractors with weather forecasts for new construction and renovation projects that are mainly used to plan for staffing, materials, and equipment. The program provides prestorm, during-storm, and poststorm weather forecasts to maintenance engineers, area supervisors, and local sheds. The type of information in each forecast and the benefits to maintenance are shown in Table 1. In addition to snow and ice control, such forecasts are also useful for the operations and projects of road rehabilitation, weed abatement, and avalanche safety.

The program creates and distributes daily weather forecasts by e-mail in a text format as weather conditions worsen. Forecasts have a 36-h time horizon. In addition, area supervisors or shed foremen can call the program office to receive nowcasts, and on average the program receives 25 calls daily (with a maximum of 75 calls). The meteorologists also call area supervisors or shed foremen if new information about the weather event indicates that an earlier forecast was inaccurate.

The UDOT Program provides weather forecasts that are much more locally specific than traditional weather services and seeks to tailor information toward use by UDOT personnel. (See Table 2 for a comparison of example language that might be included in a traditional forecast, versus the detail and customization associated with a forecast created by the UDOT program.)

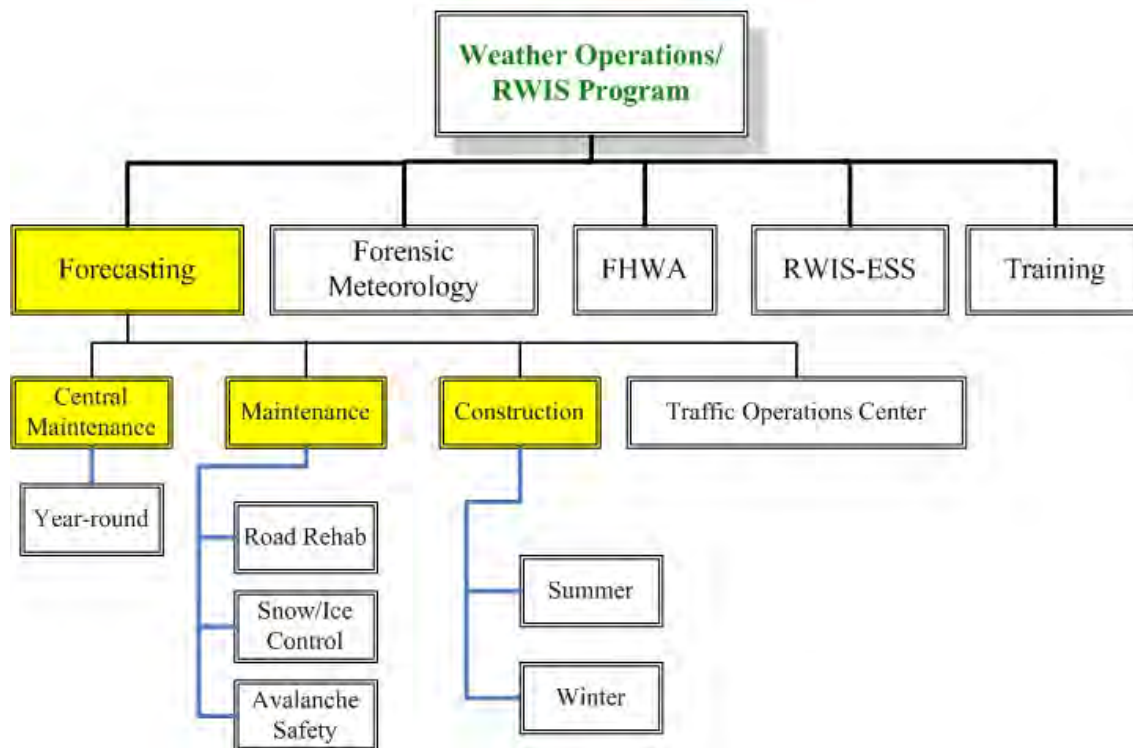

FIGURE 1 Organizational chart of UDOT Weather Operations/RWIS program's services.

TABLE 1 Information Provided by the Program to Local Maintenance Sheds

Timing	Type of Information	Application
Prestorm	<ul style="list-style-type: none"> • Timing and onset of the weather event • Rain versus snow • Temperature trends 	Key for anti-icing operations that aim to prevent the bonding of ice to the roadway by spreading chemicals before or in the early stage of a winter weather event, allowing easier removal by mechanical means.
During storm	<ul style="list-style-type: none"> • Intensity and duration of the weather event • Temperature trends 	Key for snow and ice removal operations. On the basis of the forecast, various tools could be used to remove snow and ice from roadways or to improve traction, including deicing, snowplowing, and sanding.
Poststorm	<ul style="list-style-type: none"> • Exit timing of the weather event • Blowing snow • Temperature trends 	Key for snow and ice cleanup operations.

TABLE 2 Comparison of Traditional and UDOT Forecasts

Example of Traditional Weather Forecast	UDOT Weather Forecast
Mostly cloudy with a 20% chance of light snow. Lows near 8° above. North winds 15 to 25 mph.	<ul style="list-style-type: none"> • Quick ¾ to 1 in. snow over the next 1 h. • Alerted for road concerns developing by 1400, sloppy onset. Up to 1 to 2 in. road snow for the commute tonight. • Snow band stalling again over your routes' areas. Big thing will be dropping temps W-E late afternoon Park Valley, I-15 areas around 1800. General tapering trend west desert areas after temp drop, snow I-15 corridor through 0000.

Distinctives

The UDOT Weather Operations/RWIS Program combines the weather information initiatives described earlier in several interesting ways. First, the program recognizes the need to supplement and enhance the existing weather observation network. Recognizing that the challenge for operators and winter maintenance managers occurs on the roadway environment, the program supports installation, and operation of RWIS sites across the state. In addition to this, the program has sought partnerships with other organizations in the state to offset installation costs by deploying roadside equipment in locations that could be mutually beneficial to multiple agency customers.

Beyond its observational capabilities, the program provides customized forecasting services. Its forecasts are developed using a combination of agency personnel and staff from a private-sector contractor. This results in a unique level of integration between weather information and DOT operations. The institutional integration of having an in-house

meteorologist can help to build trust between end users and the forecaster. Meteorological staff are collocated in the TOC, which supports the potential for weather forecasts to directly influence operational decisions. This can help with, for example, determining the message text and timing associated with weather-based warnings on dynamic message signs, as well as signal timing. As is the case with many private-sector providers, UDOT forecasters have worked closely with winter maintenance end users to ensure that they communicate forecasts in a way that is actionable, such as discussions of timing, rate of precipitation, and similar characteristics. In this way, the program seeks to provide decision support capabilities, though without the automation involved in MDSS. Forecasters have also worked with end users on procedural integration to ensure that the forecasts are delivered in an easy-to-access fashion. This includes “call outs” (phone calls from forecasters to maintenance foremen when forecasts are missed) as well as regular weather briefings in the TOC.

UDOT’s program is also unique in that it is structured to reach a broad variety of agency users, ranging from field maintenance to construction to operations and others. While future MDSS development is going toward this multiuser approach, the UDOT program represents an early (nonautomated) example of this type of functionality.

BENEFIT–COST ANALYSIS

Conducting a benefit–cost (B/C) analysis of UDOT’s program can help to quantify the value of integrating weather information more deeply into a transportation agency’s operations. Consequently, a recent research project sought to evaluate the benefits and costs of the UDOT Weather Operations/RWIS Program (19). This was a methodological challenge not only because of the number of program users but also because of the difficulty in assigning precise benefits to improvements in weather information. For example, improvements in weather information should support proactive winter maintenance activities that should, in turn, improve the level of service of the roadway system, which should improve user safety and delay. Each of these causal links is intuitive but is hard to quantify. Other factors, such as the relative severity of weather, could make the links even more difficult to establish.

Therefore, the scope of this analysis was limited to one portion of the overall program (weather operations), and to one group of users (winter maintenance). This was analytically desirable for several reasons. First, the costs associated with winter maintenance operations are well documented and are easily understood and communicated. The costs associated with other program customers, and more specifically how those costs may be affected by the weather operations program, are more difficult to define. Second, the costs of the weather operations portion of the program are readily identifiable, whereas the costs of the RWIS portion are somewhat difficult to define, as they spread over several divisions within UDOT. Third, it is believed that winter maintenance would be the customer most helped by improved weather information, given the resources currently spent on winter maintenance.

In summary, the B/C analysis for this study defined benefits in terms of reduced agency costs and costs in terms of the costs of sustaining the weather operations portion of the program.

Winter Maintenance Cost Model

The best way to estimate the cost savings that may have resulted from maintenance personnel using the weather operations program would be to compare the winter maintenance costs accrued using all available sources of weather information, including UDOT's weather operations program, with those accrued using all available sources of weather information, excluding UDOT's weather operations program. This comparison is valid only when all other factors are equal. However, one can seldom consider all other factors being equal when looking at winter maintenance cost data. There are obvious challenges in comparing cost data at one maintenance shed with another because of differences in roadway mileage and level of service requirements. Even in comparing within the same maintenance shed, however, there are challenges because of changes in the relative severity of winters (i.e., the need for winter maintenance operations) and the outcome of winter maintenance operations, expressed as the actual level of service.

To resolve this challenge, a winter maintenance cost model was developed. To compare the different sheds at the same baseline, it is assumed that labor and materials cost (LMC_a) for a given shed a is a function of several factors described as follows.

$$LMC_a = f(USE_a, EVLN_a, ANTI_a, LOM_a, VMT_a, WSI_a) \quad (1)$$

where

- USE_a = shed a 's overall winter usage of the UDOT service
- $EVLN_a$ = shed a 's overall evaluation of the UDOT service
- $ANTI_a$ = the level of anti-icing practice used by shed a (0 if no anti-icing; 0.5 if to start anti-icing program soon; 1 if already anti-icing)
- LOM_a = the level-of-maintenance of the winter roadways managed by shed a
- VMT_a = the vehicle miles traveled (VMT) on the winter roadways managed by shed a
- WSI_a = winter severity index for the area managed by shed a

To lessen the influence of different relative costs of labor and materials over time, the cost model was developed on the basis of data collected during the 2004–2005 winter. The actual data from this season comprises the baseline for the B/C analysis and include a mix of sheds that rely heavily on the program, those who use it occasionally, and those who do not use it.

USE and EVLN are used to capture the extent to which a maintenance shed relies on the weather operations program for weather information to support winter maintenance. ANTI reflects, at a very high level, the types of winter maintenance operations used by a particular shed. Values for these three variables were derived for each shed on the basis of telephone interviews of shed foremen conducted by the research team, and data collected by the weather operations program. LOM is a variable that reflects the pavement condition achieved during winter maintenance activities; increased values of LMC should generally result in improvements in LOM. VMT and WSI are input variables that reflect the level of need for winter maintenance; increases in either of these two variables should generally result in increases in LMC. More detail on how these variables were derived is provided in the project technical report (19).

Model Calibration

Initially, the research team sought to treat Equation 1 as a multivariable linear regression model. Fifty maintenance sheds were selected for the model, since they had acceptable traffic data and responded to the maintenance survey. Using data from these sheds, the model resulted in an R^2 value of 0.4833. The low R^2 value may be attributable to potential interactions between the investigated factors, nonlinear relationships involved, and the noise inherent in the modeling data. In addition, a comparison of the actual to modeled values of LMC resulted in relative error estimates ranging from -246.9% to +306.9%. Together, these results indicated the need to adopt another approach. The research team elected to use artificial neural networks (ANNs) as a modeling alternative.

ANNs are powerful tools to model the nonlinear cause-and-effect relationships inherent in complex processes (22), as they provide nonparametric, data-driven, self-adaptive approaches to information processing. ANNs offer several advantages over traditional, model-based methods. First, ANNs are robust and can produce generalizations from experience even if the data are incomplete or noisy. Second, ANNs can learn from examples and capture subtle functional relationships among case data. Prior assumptions about the underlying relationships in a particular problem, which in the real world are usually implicit or complicated, need not be made. Third, ANNs provide universal approximation functions flexible in modeling linear and nonlinear relationships. The ANN paradigm adopted in this study was the multiplayer feed-forward neural network, of which a typical architecture is shown in Figure 2.

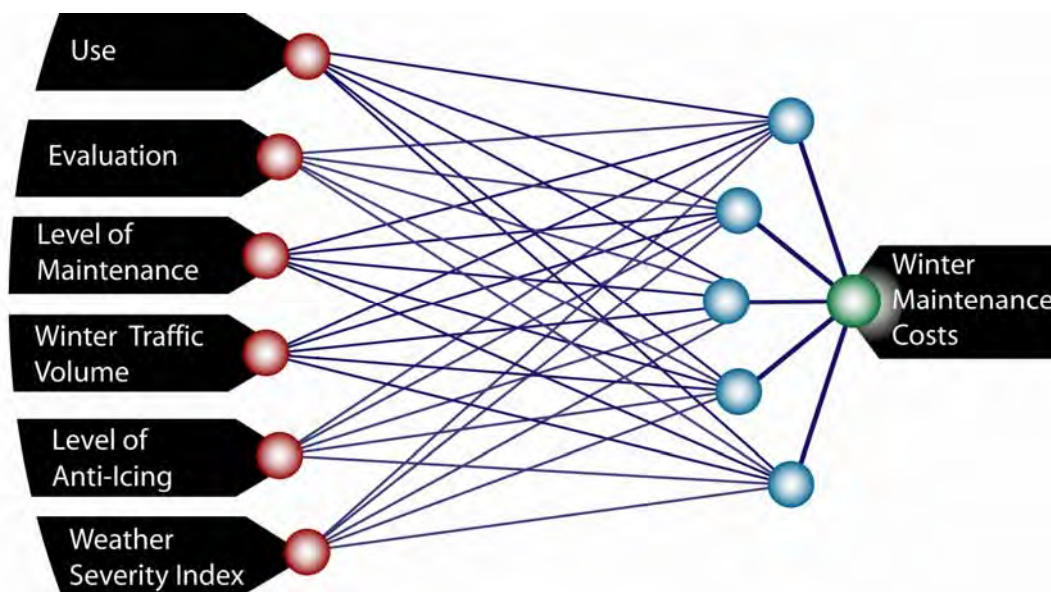

FIGURE 2 Typical multiplayer feed-forward neural network architecture.

The nodes in the input and output layers consist of independent variables and response variable(s), respectively. One or two hidden layers are included to model the dependency on the basis of the complexity of relationship(s). For a feed-forward network, signals are propagated from the input layer through the hidden layer(s) to the output layer, and each node in a layer is connected in the forward direction to every node in the next layer. Every node simulates the function of an artificial neuron. The inputs are linearly summated by utilizing connection weights and bias terms and are then transformed via a nonlinear transfer function.

For the training of the networks, an error backpropagation algorithm was adopted. All the connection weights and bias terms for nodes in different layers are initially randomized and then iteratively adjusted based on certain learning rules. For each given sample, the inputs are forwarded through the network until they reach the output layer producing output values, which are then compared with the target values. Errors are computed for the output nodes and propagated back to the connections stemming from the input layer. The weights are systematically modified to reduce the error at the nodes, first in the output layer and then in the hidden layer(s). The changes in weights involve a learning rate and a momentum factor and are usually in proportion to the negative derivative of the error term. The learning process is continued with multiple samples until the prediction error converges to an acceptable level.

One of the 50 sheds was randomly selected as the test data, and the remaining 49 samples were used as the training data. The test data were used to monitor the performance of the model during training. The training process involved selecting the appropriate number of hidden layer nodes and determining the appropriate limit of allowable training error. Then, the trained model was used to predict the dependency of LMC on the winter traffic volume managed (VMT_a) and the winter severity (WSI), respectively, with the other five factors at the median level of the 50 sheds in the modeling data set. The pattern of these two dependencies, as measured by correlation values and relative error, showed that the ANN model was properly trained, was reasonably suitable for predicting the output of unknown samples within the ranges of the modeling data, and could be used to quantify the benefits of UDOT weather service to winter maintenance (in the form of cost savings).

Results

Once the empirical ANN model was validated, it was used to predict the labor and materials costs associated with different weather information scenarios. As noted earlier, the baseline for the analysis is based on actual winter maintenance cost and program usage experience from the 2004–2005 winter. Three alternatives were compared to this baseline; this allowed for an assessment of the cost savings that were likely realized during that winter. Each alternative used the same traffic volumes, winter severity index values, average level of maintenance, and usage of anti-icing as were used in the baseline. The only variables changed in each alternative were USE and EVLN. The alternatives were compared over one winter season over 77 UDOT maintenance sheds for which there were sufficient data.

The alternatives were defined as follows:

- No program. This alternative assumes that the weather operations program did not exist and that shed foremen would use non-UDOT sources of weather information on a daily basis. The difference between this and the baseline should reflect the labor and materials costs savings in winter maintenance resulting from current usage of the weather operations program.

- **Poor information.** This alternative assumes a worst-case scenario regarding the frequency of usage of weather information sources and the perceived level of quality. Comparing this against the baseline can show the value of weather information in general.
- **Increased usage.** This alternative assumes that the UDOT weather operations program is used as the primary source of weather information by all maintenance sheds and that all sheds call the program as frequently as any shed does now. Comparing this alternative against the baseline provides an estimate of the potential added value that may be associated with greater usage of the weather operations program.

Labor and materials costs were estimated for each of these alternatives and were compared to the actual costs under the baseline condition. The statewide results are presented in Table 3. The analysis estimated that the weather operations program saved UDOT more than \$2.2 million in winter 2004–2005 in terms of reduced winter maintenance costs. Given that the program costs approximately \$200,000, this translates into a B/C ratio of more than 11:1. Additional usage of the program could provide additional benefits. However, additional usage would likely require additional staffing support for the increased telephone call volume, so it is unclear whether the B/C ratio would grow. Nonetheless, this analysis indicates that the program is quite cost-effective simply from the perspective of winter maintenance costs.

The analysis of the “poor information” alternative is interesting in that it provides an indication of the value of weather information in general. Comparing the results from the “no program” and “poor information” alternatives shows that information outside of UDOT’s weather operations program, regardless of the source, provided significant cost savings to UDOT of about \$9.6 million per year. This supports the idea that better weather information in general will more than pay for itself when it comes to winter maintenance costs.

TABLE 3 Benefits of Weather Operations Program Versus Various Alternatives

Alternative	Definition of Alternative	Cost Change as a Result of Using Program at Current Levels	Percent Change
No program	USE = 2 EVLN = 3	Mean: -\$2.244 million Range ($\pm 3\sigma$): -\$1.382 to -\$3.106 million	11% to 25% savings
Poor information	USE = 1 EVLN = 1	Mean: -\$11.864 million Range ($\pm 3\sigma$): -\$7.306 to -\$16.422 million	58% to 131% savings
Increased usage	USE = 6.19 ^a EVLN = 5 ^b	Mean: \$0.883 million Range ($\pm 3\sigma$): \$0.544 to \$1.222 million	4% to 10% in lost savings

^a Reflects the highest observed phone call levels to date.

^b Implies the UDOT weather service is used as the primary source of weather information, and its service, reliability, and usability are better than other providers.

Transferability

With an ANN approach, it is estimated that the B/C ratio associated with the program is more than 11:1, on the basis of simply the labor and materials cost savings associated with winter maintenance. The true B/C ratio of UDOT's program may be higher, as there are other program users whose economic benefits were not considered as a part of this study.

While the research project did not explore the question of whether the favorable B/C ratio demonstrated by UDOT's program can be replicated in other agency contexts, there are a few hints of program elements that may contribute to the program's success and could be transferable.

First, surveys of maintenance and construction end users indicate that the program has been effective in targeting its customers' needs. Seventy-six percent of winter maintenance personnel interviewed for this project said that UDOT's forecasts were more reliable than other weather information services, and 85% said that they were more usable. Further, 90% of maintenance personnel respondents indicated that the UDOT weather operations program provided a better level of service than other weather information services that they might have used (19).

Related to this, UDOT's winter maintenance users had a sense of how improved weather information can reduce labor and materials costs and thereby add value to their work activities. Earlier training and outreach efforts had promoted usage of anti-icing by many UDOT maintenance personnel, and there were already investments in equipment and materials to support proactive snow and ice control. Consequently, winter maintenance personnel understood the potential value of improved weather information, knew the type of information that they required, and had the equipment and resources to act on that information. Against this backdrop, the authors recognize that there were many transportation agencies for which anti-icing was not practical because of a lack of appropriate equipment, specific climatic challenges, or other reasons. The general lesson remains: the end users need to understand how the weather information can be used to help them in their job duties in order for the information to have real value.

This leads to a third point, regarding the level of integration between UDOT's Weather Operations/RWIS program and its customers. The programs' focus on integration (at the physical, procedural, and institutional levels) has ensured that the right information is delivered at the right time in the right way. While many weather information providers do an excellent job of procedural integration, they are generally lacking at the physical and institutional levels. While this study did not quantify the cost-effectiveness of less integrated solutions, such as the use of an off-site private-sector weather forecast provider, it appears that the additional integration included in UDOT's program has not hindered the use of weather information in any way and may indeed have resulted in even greater benefits.

Finally, with respect to transferability, it is recognized that Utah is a state with exceptional climatological diversity. Annual precipitation can range from more than 40 in. per year (equivalent to hundreds of inches of snow) in the Wasatch Mountains to less than 5 in. per year in the desert. A main contributor to the state's diversity is its mountainous terrain, including the Wasatch Range and Uinta Mountains in the northern part of the state, with other ranges located elsewhere in the state (23). Storm patterns can come from several directions, bringing varying combinations of moisture from the south and west and cooler temperatures from the north. This diversity introduces technical challenges in weather forecasting. These challenges are

overlaid on a state that has some rapidly growing urban areas and through which I-80 carries significant volumes of long-distance and goods movement traffic. The challenges of forecasting, and the consequences of missed forecasts, may be different in other areas, so the potential benefits may vary as well.

SUMMARY

This paper has reviewed UDOT's Weather Operations/RWIS program as one example of effective integration of weather information into a transportation agency's operations. The program combines the trends reflected in several innovative weather information initiatives in a way that has proved cost-effective in the area of winter maintenance. Perhaps the central element defining the program's success is its level of integration. While the program's success may not be perfectly replicated elsewhere, elements from the integration approach could prove useful.

ACKNOWLEDGMENTS

The authors thank Shaowei Wang and Katie O'Keefe from the Western Transportation Institute, whose work in supporting the B/C analysis was invaluable, and Ralph Patterson from UDOT and Glen Merrill of NorthWest Weathernet for their insights into the weather operations program, its customers, and its purposes. The authors extend their sincere appreciation to Doug Anderson, UDOT project manager, for his assistance throughout this project. The authors also thank the numerous UDOT personnel who participated in interviews with research team members. Finally, the authors thank UDOT and the U.S. Department of Transportation Research and Innovative Technology Administration for their funding of this research.

REFERENCES

1. *Weather Information for Surface Transportation: A National Needs Assessment Report*. Publication FCM-R18-2002. Office of the Federal Coordinator for Meteorological Services and Supporting Research, National Oceanic and Atmospheric Administration, U.S. Department of Commerce, Washington, D.C., 2002.
2. *How Do Weather Events Impact Roads?* Office of Operations, Road Weather Management Program, FHWA, U.S. Department of Transportation. http://ops.fhwa.dot.gov/Weather/q1_roadimpact.htm. Accessed July 27, 2007.
3. *Clarus—America's 21st Century Surface Transportation Weather Observing and Forecasting System*. Publication No. FHWA-HOP-04-037. Road Weather Management Program, Office of Transportation Operations, FHWA, U.S. Department of Transportation, 2004.
4. Murphy, R. *Clarus—Nationwide Surface Transportation Weather Observing and Forecasting System*. ITSA Rural Stakeholder Interest Group, ITS America Annual Meeting, Phoenix, Ariz., 2005.
5. O'Keefe, K., and X. Shi. *Anti-Icing and Pre-Wetting: Improved Methods for Winter Highway Maintenance in North America*. Presented at 85th Annual Meeting of the Transportation Research Board, Washington, D.C., 2006.
6. Block, C. B., J. J. Mewes, and S. G. Gaddy. *Supporting Surface Transportation Weather Forecasting at Meridian Environmental Technology, Inc.* Presented at American Meteorological Society's 19th Conference on Interactive Information Processing Systems, Long Beach, Calif., 2003.

7. Pisano, P. FORETELL: Finally, Someone Is Doing Something About the Weather! *Public Roads*, Vol. 64, No. 5, 2001.
8. Davies, P., D. Deeter, and C. E. Bland. FORETELL: Providing Integrated Weather Information Services Across the Upper Midwest. *Proc., 1998 Transportation Conference*, 1998.
9. Schrank, D., and T. Lomax. *The 2007 Urban Mobility Report*. Texas Transportation Institute, Texas A&M University, September 2007.
10. *Traffic Congestion and Reliability: Linking Solutions to Problems*. Prepared for FHWA. Cambridge Systematics and Texas Transportation Institute, July 2004.
11. Cluett, C., F. Kitchener, D. Shank, L. Osborne, and S. Conger. *Integration of Emergency and Weather Elements into Transportation Management Centers*. Report No. FHWA-HOP-06-090. FHWA, U.S. Department of Transportation, 2006.
12. Cambridge Systematics. *Weather-Responsive Traffic Management: Concept of Operations* (draft), Prepared for FHWA, U.S. Department of Transportation, January 10, 2003.
13. Strong, C., J. Eidswick, and E. Cuelho. Synthesis of Customer Needs From Rural Traveler Information Surveys. Presented at 85th Annual Meeting of the Transportation Research Board, Washington, D.C., 2006.
14. Goodwin, L., and P. Pisano. Current Practices in Transportation Management During Inclement Weather. Presented at 2002 ITE Annual Meeting and Exhibit, Philadelphia, Pa., August 4–7, 2002.
15. Robinson, M., P. McGowen, A. Habets, and C. Strong. *Safety Applications of ITS in Rural Areas*. Prepared for ITS Joint Program Office, September 2002. Available at www.itsdocs.fhwa.dot.gov/JPODOCS/REPTS_TE//13609.html. Accessed November 29, 2007.
16. Manfredi, J., T. Walters, G. Wilke, L. Osborne, B. Hart, T. Incrocci, and T. Schmitt. *Road Weather Information System Environmental Sensor Station Siting Guidelines*. Report FHWA-HOP-05-026. FHWA, U.S. Department of Transportation, 2005.
17. Pisano, P. A., J. S. Pol, L. C. Goodwin, and A. D. Stern. FHWA's Clarus Initiative: Concept of Operations and Associated Research. *Proc., 22nd International Conference on Interactive Information Processing Systems for Meteorology, Oceanography, and Hydrology, 2006*. Available at <http://ams.confex.com/ams/pdfpapers/101715.pdf>. Accessed November 29, 2007.
18. Davies, P., D. Deeter, and C. E. Bland. FORETELL: Providing Integrated Weather Information Services Across the Upper Midwest. *Proc., Crossroads 2000 Conference*, Ames, Iowa, 1998.
19. Shi, X., K. O'Keefe, S. Wang, and C. Strong. *Evaluation of Utah Department of Transportation's Weather Operations/RWIS Program: Phase I Final Report*. Western Transportation Institute, Montana State University, Bozeman, 2007.
20. Horel, J., T. Potter, W. Dunn, J. Steenburgh, M. Eubank, M. Splitt, and D. J. Onton. *Weather Support for the 2002 Winter Olympic and Paralympic Games*. American Meteorological Society, February 2002.
21. Patterson, R. *Weather Operations and Intelligent Transportation Systems in the State of Utah: A Merging of Technology and the Human Intellect*. Utah Department of Transportation, 2005.
22. Shi, X., P. Schillings, and D. Boyd. Applying Artificial Neural Networks and Virtual Experimental Design to Quality Improvement of Two Industrial Processes. *International Journal of Production Research*, Vol. 42, No. 1, 2004, pp. 101–118.
23. *Climate of Utah*. Desert Research Institute, Western Regional Climate Center. Available at www.wrcc.dri.edu/narratives/UTAH.htm. Accessed July 19, 2005.

Role of Surface Friction in Winter Maintenance

ROLE OF SURFACE FRICTION IN WINTER MAINTENANCE

An Approach to Terrain Classification to Improve Road Condition Forecasts of Maintenance Decision Support Systems

MAX S. PERCHANOK

Ontario Ministry of Transportation

Recently introduced maintenance decision support systems for winter maintenance operations incorporate the outcome of planned plowing and salting operations on meteorological forecasts of highway snow cover to provide a route-specific, tactical plan for storm events. The forecast is limited by meteorological input at the scale of roadway weather information system (RWIS) stations that does not address local variance due to drifting snow. This study investigates the influence of roadside terrain on snow accumulation and proposes a terrain classification approach for predicting local differences. This study uses surface friction measurements to estimate snow cover continuously along maintenance routes at repeated intervals through winter storms. Relationships between friction, roadside terrain features, and meteorological conditions are demonstrated using mapping, spatial correlation, and frequency domain analyses. This approach to mapping snow cover and classifying terrain can be applied to more accurately interpolate snow cover information between RWIS stations, and predict differences in demand for maintenance equipment or requirements for road salt between RWIS stations.

With increasing public demands for safe road conditions during winter storms and for protection of the environment through reduced use of road salt, highway agencies rely more and more heavily on accurate road weather information and decision support tools. Roadway weather information systems (RWIS) and more recently maintenance decision support systems (MDSS) have been developed to respond to this need. MDSS includes features such as algorithms for predicting road weather conditions between RWIS observing stations (MDSS, 2006). This is intended to improve the road maintainer's selection of maintenance treatments and chemicals, for example, by varying application rates with maintenance demand along a salting route.

Several approaches have been taken to predict variations in maintenance demand within the scale of an RWIS network that formerly were treated as random events predictable only through the intuition of highway patrollers. Approaches include climatological mapping of surface temperatures to predict ground frost (Bogren et al., 2000) and improved weather forecasting (MDSS, 2006), but neither addresses variations in snow accumulation within the scale of a maintenance route that are critical to planning tactical snow control operations.

OBJECTIVES

The purpose of this study is to demonstrate the influence of terrain features on highway snow cover during winter storms, and to explore classification of roadside terrain to aid in predicting snow cover on a local scale.

APPROACH AND BACKGROUND

The overall approach was to postulate factors that affect highway snow cover over a variety of scales, focusing on those believed to be significant on a local scale defined by the typical distance between RWIS observing sites. Snow cover was measured continuously along winter maintenance routes, local terrain features were measured or classified, and statistical relationships were uncovered between them.

Snow accumulation on highways is influenced by a variety of natural and human factors, some within scales that can be monitored by an RWIS network and others that cannot (Table 1). Features at scales under 10^4 m are invisible to RWIS but are visible to motorists and highway users. These include frost hollows, icy bridge decks, and snow drifting zones. This study is concerned with the latter.

Snow drifting has been modeled theoretically using a variety of approaches, many of which are reviewed by Pomeroy and Gray (1995). Some form the basis for semi-empirical models that have been applied to estimate variations in snow cover on highways (Tabler, 2004; Perchanok, 1997; MTO, 1998). Progress has also been made in predicting changes in snow cover due to maintenance interventions (Lee et al., 2006).

This paper explores the association of snow cover with roadside terrain at a micro-scale with respect to highway maintenance routes. It provides guidance to future prediction of snow conditions between RWIS stations by classifying roadside terrain with respect to its effects on drifting snow.

ANALYSIS METHODS

The analysis used frequency domain and conventional statistical methods to uncover relationships between terrain and snow cover during winter storms. Autocorrelation analysis and power spectra of friction traces were used to test for relationships between snow cover and roadside terrain features. Regression analysis was used to test for interactions between terrain classes and wind conditions as determinants of snow cover.

The autocorrelation function (ACF) is a measure of the correlation of progressively lagged sample points in a stationary series. Its coefficients range from 0 for a random series to 1 for perfect correlation. The spectral density function (SDF) expresses variance in the data set as a Fourier transform of the autocovariance function, averaged over a defined window to show trends in variance at discrete ranges of period or frequency.

TABLE 1 Scale of Processes Affecting Highway Snow Cover

Process	Scale (m)
Weather system	10^5
Lake effect, orographic effect	10^4
Salting and plowing	10^4
Traffic volume	10^4
Forest	10^3
Bridge, roadside vegetation	10^2
Rock cut, shading	10^1

Local maxima in the averaged power plotted against frequency show the periodicity of variance from the mean of the set. Frequency domain analysis has previously been applied to classify pavement texture under summer conditions (Rado, 1994).

Multiple linear regression (MLR) is a statistical method that estimates coefficients by which one or more independent predictor variables are related to a dependent, in the form

$$Y = a + bX + cY + \dots \quad (1)$$

The coefficients (b, c, \dots) estimate the linear relationship between each predictor and the dependent, in the presence of other predictors. Standardized (Beta) coefficients estimate the relative influence of each predictor ($X, Y, \text{etc.}$) in relation to other predictors (SPSS, 1999).

The large series of evenly spaced measurements provided by a continuous friction trailer is ideally suited to analysis in the frequency domain, while successive traverses of one route provide independently varying samples suitable to multiple regression analysis.

DATA COLLECTION

Investigation of the key postulated factors requires snow cover measurement at a scale of 10^1 m along a highway. Snow cover on a highway is however difficult to measure in a continuous and timely manner. Perchanok (2002) developed an approach to continuous estimation of fractional snow cover on pavement using a continuous friction measuring device (CFM), and showed that the friction coefficient (μ) and snow cover fraction are inversely related by an equation such as:

$$\text{Snow cover fraction} = (-.3645 \times \text{LnMup}) + (.0054 \times \text{Vcrit}), \quad (2)$$

where LnMup is the natural log of the maximum generated friction Mup and Vcrit is the measuring wheel slip speed. More recently, Fu et al. (2008) used a logistic model to classify snow cover using a different friction device.

As a result, continuous measurements of friction coefficient are used in this study as a surrogate for fractional area of snow cover along the pavement. Given the strong evidence of a relationship, friction is used as the primary measure in this study.

Friction was measured using a Norsemeter variable slip friction trailer (Figure 1), which provides an estimate of the maximum obtainable friction coefficient in successive 29-m sample footprints.

Terrain data were obtained from geographic websites and from the Ontario, Canada, Ministry of Transportation's transportation mapping interface (TMI). The spacing of terrain features was measured from satellite imagery, while elevations were measured from a topographic database in TMI. A terrain profile was obtained in one area by averaging elevation over 150-m intervals at an offset of 100 m east from the highway centerline. This is the elevation of the surrounding terrain through which the highway is superimposed, as opposed to the pavement elevation.

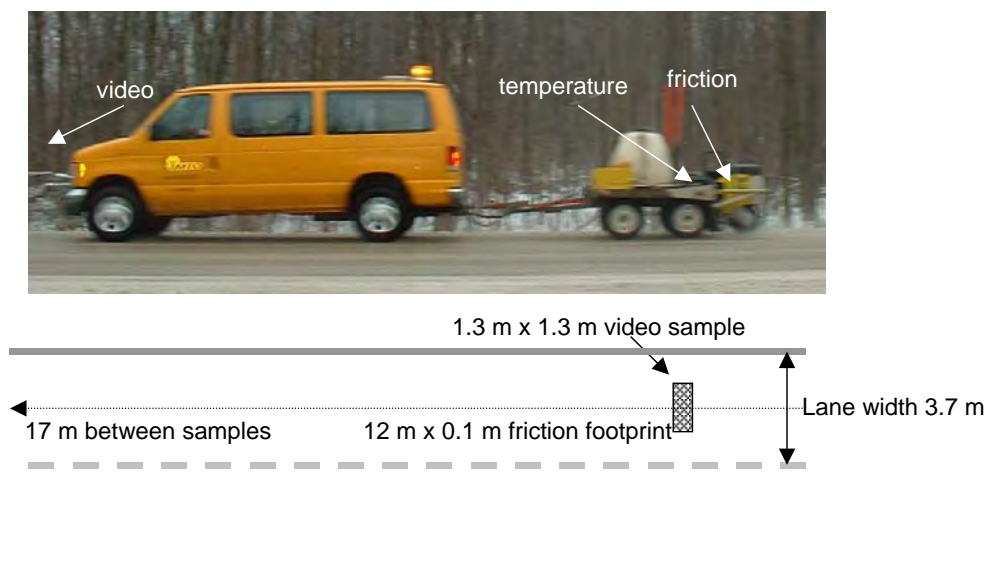

FIGURE 1 Mobile data acquisition system and sampling characteristics (ROAR Mk2).

FIELD AREAS

Data sets were acquired from three field areas in southern Ontario, Canada, each characterized by different terrain features (Chapman and Putnam, 1973).

Area 1 is a level region of farm fields that are unvegetated in winter. Roadside ditches are inhabited by bushes that act as windbreaks, and these are intersected at intervals by concession roads and farm laneways (Figure 2).

Area 2 crosses a region of drumlins, groups of teardrop-shaped hills, which create a landscape of characteristically sinusoidal profile (Figure 3). Road construction through the drumlins results in alternating cut and fill sections of similar scale to the terrain. The drumlin tops are forested, and the valley bottoms are farmed, with fields bare of vegetation in winter. The north part of Area 2 crosses irregular moraine topography with a mix of forest and farm fields.

Area 3 crosses three topographic zones; a level, forested area of former glacial lake deposits; a glacial moraine dissected by streams; and level farm fields that are bare of vegetation in winter. The latter zone can be divided into areas differing in highway alignment (Figure 4, Table 2).

Highways in all field areas are serviced according to Ontario Winter Class 1 standards requiring that snow is plowed before 1.2-cm accumulation and then on a 1.2-h cycle and that road salt or winter sand is applied on a 1.8-h cycle when snow cannot be removed by plowing. Plowing and salting operations were carried out independently at the time of this study.

Wind, temperature, and precipitation data were obtained from the Environment Canada archive for Warton, an hourly recording station in the same climatic zone and located 50 to 100 km from the study sites.



FIGURE 2 Field Area 1: Highway 9 westbound and Highway 4 southbound.

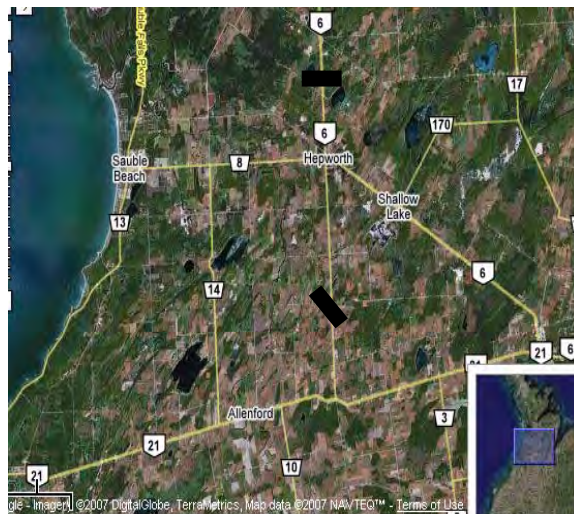

FIGURE 3 Field Area 2: Highway 21 eastbound, county road.

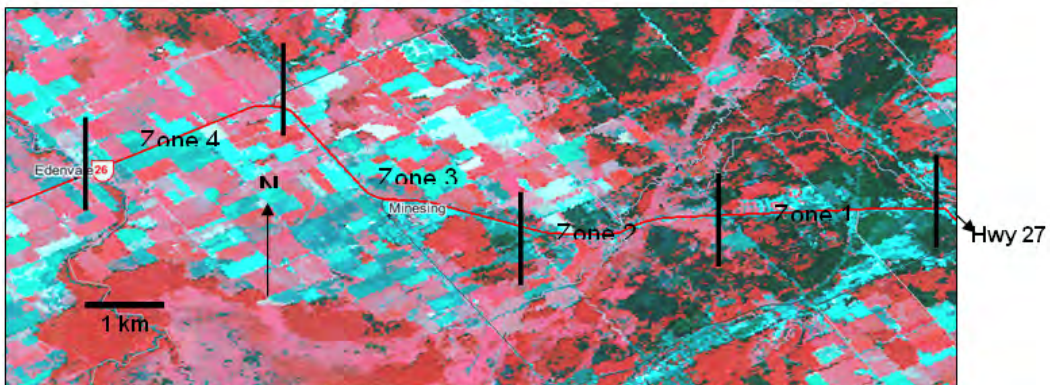

FIGURE 4 Terrain zones in Field Area 3 (false-color satellite image).

TABLE 2 Wind Shelter Zones, Area 3

Zone	Heading	Shelter	Location (m from Hwy 27)
1	EW	Sheltered	0–3,000
2	EW	Partial shelter	3,001–6,000
3	NS	Exposed	9,001–10,000
4	EW	Exposed	10,000–14,000

DATA COLLECTED

The spacing of terrain features as measured from the terrain data sources is shown in Table 3. The amplitude of drumlins in Area 2 is approximately 10 m.

A single friction trace was acquired in Areas 1 and 2 (Figures 5, 6), each during a period of subfreezing temperature and strong east wind on the day following a major snow storm. Nine friction traces were acquired for Area 3 over a 12-h period during a major winter storm. Three traverses are illustrated here (Figure 7); Traverse 1 was under heavy snowfall and light wind conditions, Traverse 3 was under moderate wind conditions, and Traverse 9 was under high wind conditions

TABLE 3 Spacing of Terrain Features in Areas 1 and 2

Area	1			2	
Highway	9	4	21	10	6
Interval (m)	200	1,000	500	500	—
Feature	road	road	drumlin	drumlin	N/A

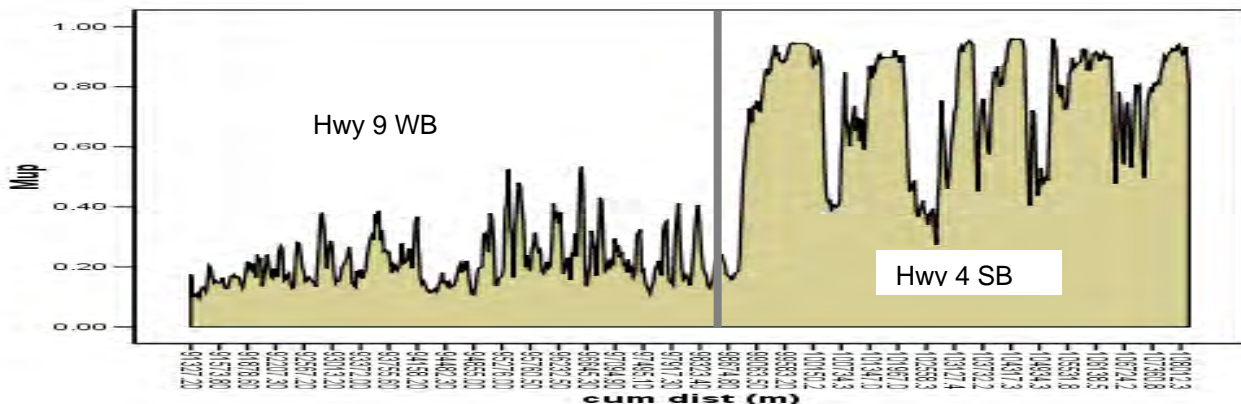

FIGURE 5 Friction trace for Field Area 1.

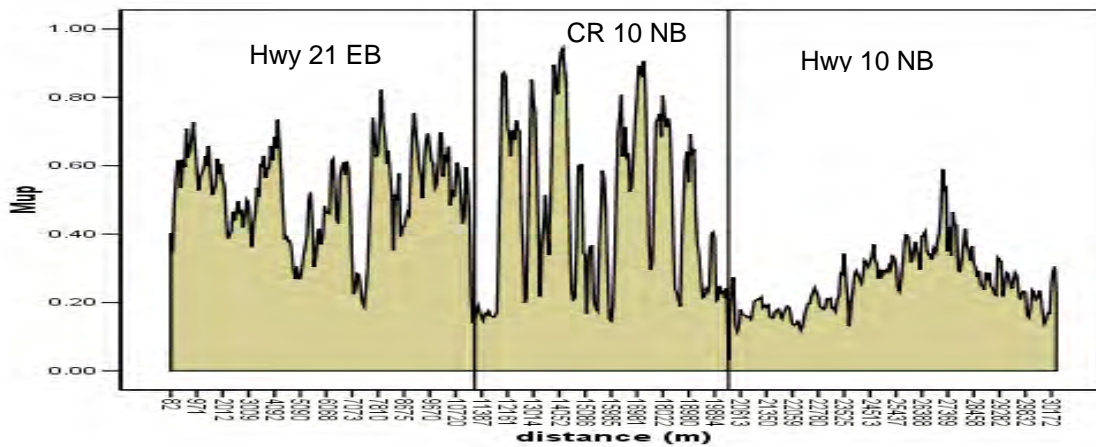

FIGURE 6 Friction trace for Field Area 2.

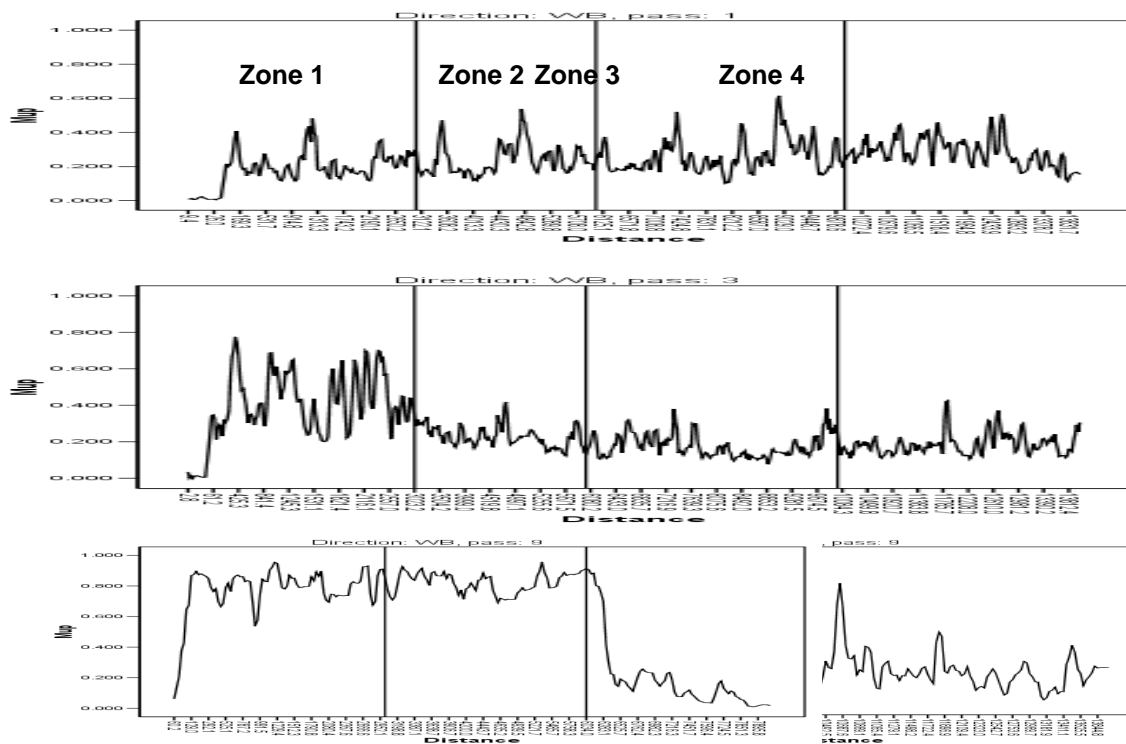

FIGURE 7 Friction traces for Traverses 1, 3, and 9 in Zones 1–4 of Field Area 3.

ANALYSIS

All of the friction traces exhibit zonal characteristics that are stationary but differ in mean value and variance structure. These were investigated spatially using frequency domain methods for Areas 1 and 2 and temporally for Area 3.

In Area 1 the Highway 9 section exhibits a low mean and irregular variance, while the Highway 4 section exhibits a higher mean and periodic variance despite identical maintenance standards and treatments. The two sections differ only in orientation to the easterly ambient wind.

The ACF (Figure 8) shows no periodicity on Highway 9, which is parallel to the ambient wind, but strong periodicity on Highway 4, which is perpendicular to the wind. The SDF estimates a variance peak at 50 cycles (Figure 9), equivalent to a mean interval of 1,250 m. This corresponds closely to the spacing of farm lane intersections (Table 4).

A *t*-test showed highly significant difference between means for Highways 9 and 4 ($\alpha < .000$, $\mu = .51$).

The analysis shows the direct influence of individual driveways and intersecting roads in determining the mean and variance structure of friction under strong wind conditions in open terrain, and that different friction conditions are associated with highway orientation relative to wind direction.

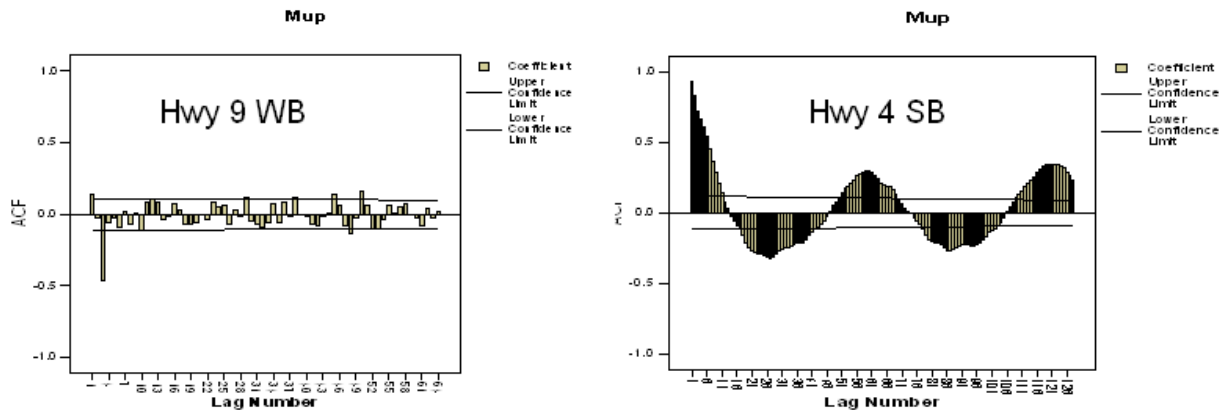

FIGURE 8 Autocorrelation function of friction, Area 1, March 10, 1999.

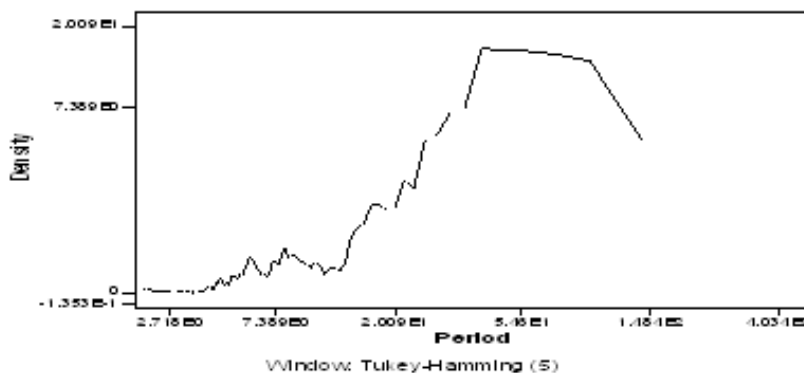

FIGURE 9 Spectral density function for Highway 4, Area 1.

TABLE 4 Terrain and Friction Data

Area	Highway	Friction Measurement				Terrain Feature	
		<i>n</i>	Sample Interval (m)	Spectral Period	Interval (m)	Interval (m)	Type
1	Hwy. 9	324	26.9	N/A	—	200	Road
	Hwy. 4	280	34.2	50	1,250	1,000	Road
2	Hwy. 21	176	63.5	25	447	500	Drumlin
	CR10	147	61.2	15	600	500	Drumlin
	Hwy. 6	191	51.0	N/A	—	—	N/A

The friction trace for Area 2 exhibits three zones of differing variance structure: moderate variance and persistence on Highway 21 eastbound, high variance and periodicity on County Road 10 northbound, and lower mean and variance with no periodic structure on Highway 6 northbound. The autocorrelation functions (Figure 10) confirm patterns observed on the raw traces. Zone 1 had a weak periodic structure; Zone 2, a stronger periodic structure, while Zone 3 has no structure. The spectral densities (not shown) indicate periodicities in Zones 1 and 2 centered on intervals of 447 and 600 m, respectively. The first two zones cross an area of similar topography but in perpendicular directions while the third zone follows the same direction as the second but in different topography. Periodicities in the first two zones correspond closely with the mean spacing of drumlin topography through which the highway passes (Table 4).

Cross-correlation between roadway friction and the elevation of adjacent terrain is evident in spatially averaged data for County Road 10 (Figure 11).

A *t*-test applied to the friction measurements of Zones 1 and 2 showed a significant difference ($\mu=.21$), but the mean difference ($\mu=0.03$) was within the tolerance of measurement and therefore it may be concluded that friction did not differ between zones. The difference between Zones 2 and 3 ($\mu =.23$) exceeded the measurement tolerance and was highly significant ($\alpha<.000$).

This analysis shows the influence of geomorphological features through which the highway traversed in the mean and variance structure of friction during strong wind

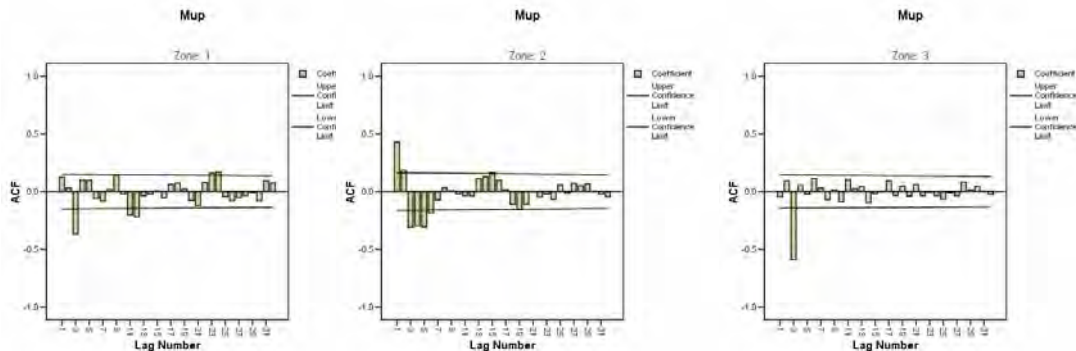

FIGURE 10 Autocorrelation function of friction trace, Area 2, January 31, 2002.

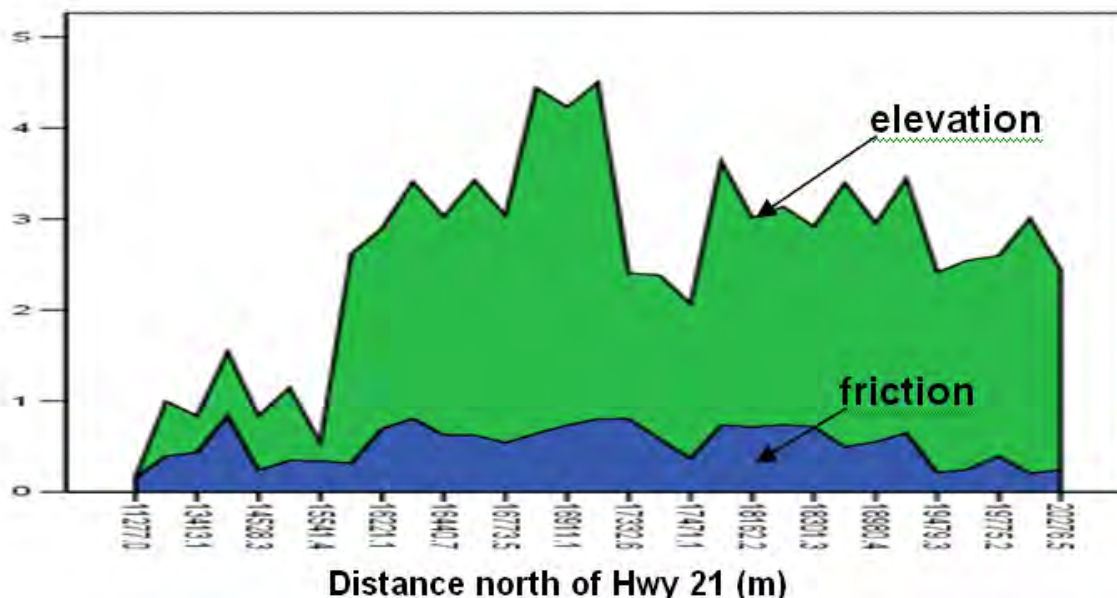

FIGURE 11 Averaged friction and elevation for Zone 2 of Field Area 2.

conditions; friction was higher in areas where landforms and associated vegetation provided wind shelter, and lower where they promoted snow drifting. This effect of terrain on variance structure of friction was more pronounced where the highway alignment was perpendicular to ambient wind direction.

Friction for Area 3 was sampled at nine intervals through a snowstorm, to provide an understanding of variance with both location and time, as illustrated by Traverses 1, 3, and 9 (Figure 12). Traverse 1 exhibits a stationary trace through all zones, with low mean and periodic spikes. Traverse 3 exhibits zonal trends, with mean and variance both decreasing from Zone 1 to 4. Traverse 9 had high mean and low variance in Zones 1 and 2, and low mean with moderate variance in Zones 3 and 4.

Zonal trends in Area 3 correspond with differences in wind shelter conditions provided by roadside topography (Table 2). Mean differences in friction between zones were not significant during the initial period of heavy snowfall with low winds. Differences were significant between zones of wind shelter and exposure in periods when wind speed exceeded 10 kph. Friction across the plow route responded as a population under low wind conditions but zonally by wind shelter under high wind conditions.

A regression analysis was applied to Zones 1 and 4 to test this hypothesis. Zones 2 and 3 were excluded because Figure 12 suggests these are transitional between Zones 1 and 2 in response to wind.

Coefficients were estimated for the mean friction of Zone 1 and of Zone 4 as a function of the traverse (pass) number, and the mean wind speed and mean wind direction for each traverse, using data from each of the nine traverses. Model coefficients were estimated separately for Zone 1 and Zone 4 to compare the relative influence of wind on friction coefficient in areas that are wind sheltered and wind exposed. Coefficients were predicted through the origin to standardize the analysis to a common condition, and results were

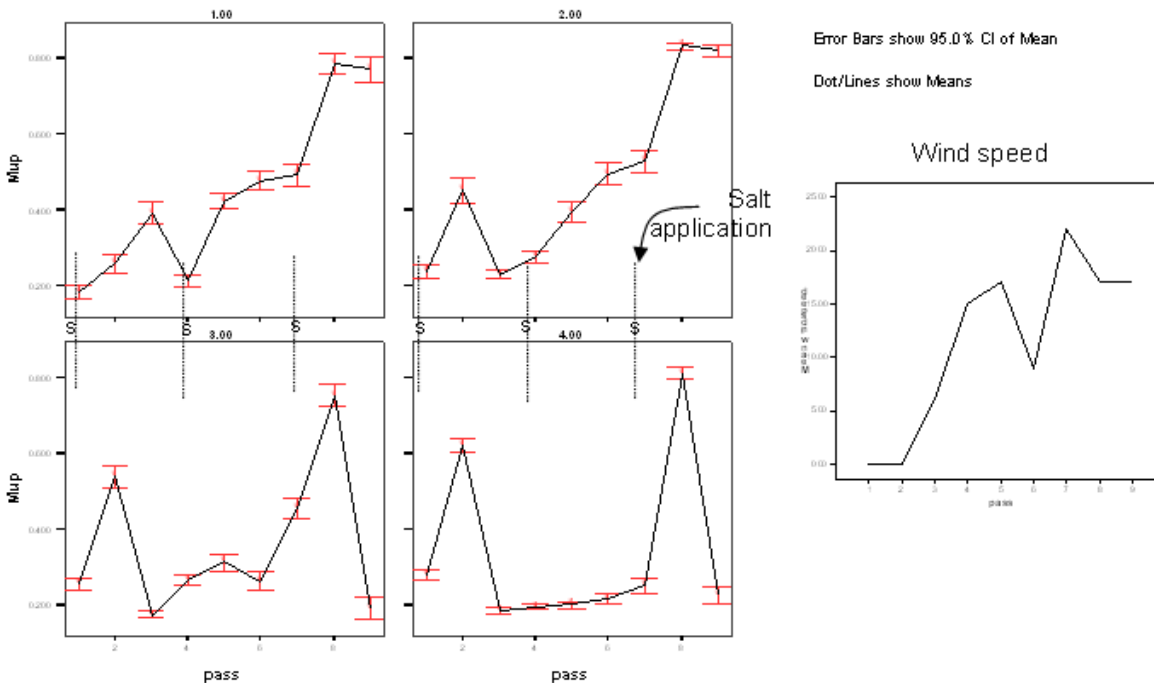

FIGURE 12 Mean friction, wind speed, and times of salt application for nine traverses in Zones 1, 2, 3, and 4, Field Area 3, January 9, 1999.

interpreted using the Beta coefficient to account for the different scales of predictor variables in comparing the importance of wind speed in controlling highway friction between wind-sheltered and unsheltered highway sections.

High r^2 indicates that models for both zones provide strong prediction of friction (Table 5). Standardized (Beta) regression coefficients show that the influence of each predictor varied by zone. Measurement pass number was the most influential variable in Zone 1, where it was more than twice as influential as wind speed. Wind speed was the strongest variable in Zone 4, while pass number had no significant influence on friction. Thus, mean friction levels were differentiated by zones determined by wind shelter conditions.

A t -test applied to mean friction in Zones 1 and 4 showed significant differences through all traverses except Traverse 8; however, mean differences for Traverses 1, 4, and 8 were within the tolerance of friction measurement. Therefore it can be concluded that significant differences occurred in six of the nine measurement events.

The potential for error in estimating snow cover from information in a nearby but dissimilar terrain zone is illustrated by exceedances of snow cover fraction for Zones 1 and 4 over the 12-h storm period monitored in Area 3 on January 9, 1999 (Figure 13). Snow cover was estimated using Equation 1. The exceedances indicate that 95% of the measurements in Zone 1 had snow cover lower than 50% beginning in Traverse 5 while Zone 4 did not reach that level at any time during the measurement period.

TABLE 5 Regression Summary and Coefficients for Area 3

Model Summary					
Zone	Model	R	R ²	Adjusted R ²	Standard Error of the Estimate
1	1	.995 ^a	.990	.984	.062055
4	1	.964 ^a	.929	.887	.137583

^a Predictors = wind direction, wind speed, pass.

NOTE: Linear regression through the origin.

Coefficients									
Zone	Model		Unstandardized Coefficients		Standardized Coefficients	t	Sig.	95% Confidence Interval for B	
			B	Std. Error	Beta			Lower Bound	Upper Bound
1	1	Pass	.103	.012	1.140	8.373	.000	.071	.135
		Wind speed	-.017	.005	-.420	-3.307	.021	-.030	-.004
		Wind direction	.000	.000	.245	1.741	.142	.000	.001
4	1	Pass	.069	.027	.911	2.517	.053	-.001	.139
		Wind speed	-.051	.011	-1.537	-4.553	.006	-.080	-.022
		Wind direction	.002	.001	1.361	3.638	.015	.001	.003

Note: Dependent variable = mean; linear regression through the origin.

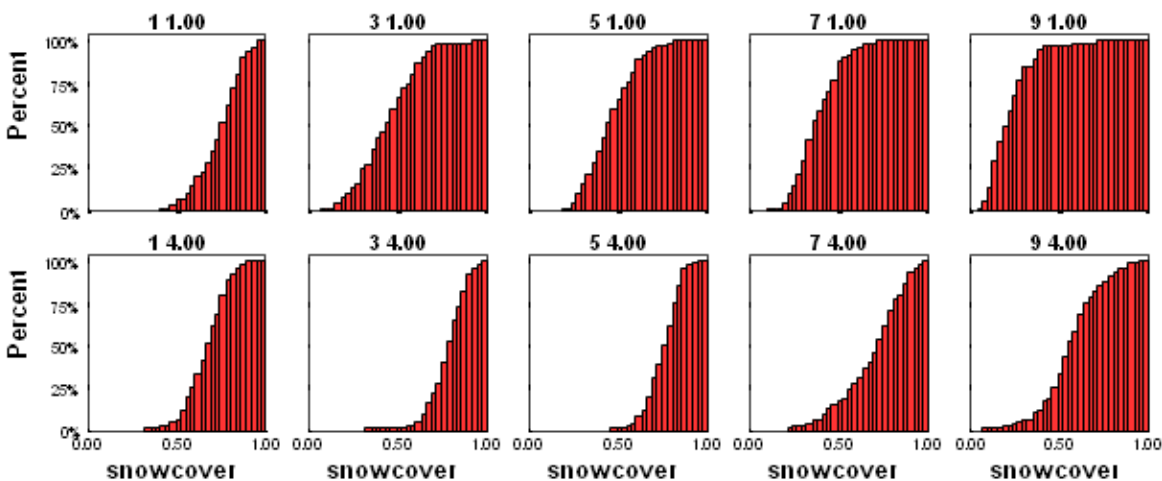

FIGURE 14 Exceedance of highway snow cover by wind shelter zone and sample traverse (Area 3, January 9, 1999).

The analysis from Area 3 demonstrates that initial friction conditions along a 14-km plow route through four terrain zones had similar mean and variance structure under heavy snowfall and light wind conditions, indicating that highway snow cover was influenced by similar underlying processes. Mean and variance structure became increasingly differentiated between wind shelter zones under strong wind conditions.

CONCLUSIONS AND DISCUSSION

The application of friction measurements as a surrogate for fractional snow cover provides new opportunities to analyze fine detail in the spatial pattern of surface conditions on highways. It provides an understanding of factors controlling snow accumulation from the microscale of individual terrain elements to the mesoscale of terrain zones to the macroscale of highway routes.

The regular, closely spaced sampling regime of CFM provides access to frequency domain analysis methods that have not been applied previously to highway operations or to snow cover mapping. This allows the analysis of variance structure in process investigations, which may lead to improved understanding of temporal changes in snow cover and to prediction of highway surface conditions during winter storms. This can be applied to improving forecasts of the demand for winter maintenance resources.

The analyses showed that snow cover is not uniform within the spatial scale of a weather system or even at the scale of a plow route, but varies at the scale of roadside terrain zones and of individual terrain features that control snow drifting within the zones.

These local controls on snow cover imply that estimates of snow cover that are based on data from RWIS can be interpolated with confidence within a terrain zone and between similar terrain zones, but can only be interpolated to dissimilar terrain zones under calm weather conditions, even when those zones are located within a short distance of the observing station.

REFERENCES

- Bogren, J., T. Gustavsson, M. Karlsson, and U. Postgard. The Impact of Screening on Road Surface Temperature. *Meteorology*, Vol. 7, 2000, pp. 1–8.
- Chapman, L. J., and D. F. Putnam. *The Physiography of Southern Ontario*, 2nd ed. University of Toronto Press, 1973.
- Fu, L., R. Sooklall, and M. Perchanok. Effectiveness of Alternative Chemicals for Snow Removal on Highways. In *Transportation Research Record: Journal of the Transportation Research Board*, No. 1948, Transportation Research Board of the National Academies, Washington, D.C., 2006, pp. 125–134.
- Fu, L., F. Feng, and M. Perchanok. Probabilistic Models for Discriminating Road Surface Conditions Based on Friction Measurements. Presented at 87th Annual Meeting of the Transportation Research Board, Washington, D. C., 2008.
- MDSS National Laboratory Consortium. The Maintenance Decision Support System Project (MDSS). Prototype Release 4.0 System Description Version 1.1. Federal Highway Administration, Road Weather Management Program, February 13, 2006.
- MTO. *Design and Maintenance Procedures to Minimize Impacts from Drifting Snow on Highways—Provisional Guidelines*. Report MAT-98-01. Research and Development Branch, Ontario Ministry of Transportation, Downsview, October 1998.
- Perchanok, M. SNOWDRIFT Environmental Modelling System: An Independent Implementation of SHRP Study Results. International Roads Federation World Congress, Toronto, Canada, June 1997.
- Perchanok, M. Patchiness of Snow Cover and Its Relation to Quality Assurance in Winter Operations. World Road Association-PIARC Winter Road Congress, Sapporo, Japan, January 2002.

- Pomeroy, J. W., and D. M. Gray. *Snowcover; Accumulation, Relocation and Management*. National Hydrology Research Institute Science Report No. 7, Environment Canada, Saskatoon, 1995.
- Rado, Z. A Study of Road Surface Texture and Its Relationship to Friction. PhD dissertation. Pennsylvania State University, 1994.
- SPSS. Statistical Package for the Social Sciences, Base 9.0 Applications Guide. SPSS Inc., Chicago, Ill., 1999.
- Tabler, R. D. Effect of Blowing Snow and Snow Fences on Pavement Temperature and Ice Formation. *Transportation Research Circular E-C063: Sixth International Symposium on Snow Removal and Ice Control Technology*, Transportation Research Board of the National Academies. 2004, pp. 401–413.

ROLE OF SURFACE FRICTION IN WINTER MAINTENANCE

A Probabilistic Model for Discriminating Road Surface Conditions Based on Friction Measurement**L. FU
F. FENG***University of Waterloo***MAX S. PERCHANOK***Ontario Ministry of Transportation*

The latest advances in sensor technologies, such as road weather information systems, continuous friction measurement equipment, and web cams, have afforded new opportunities for improved road condition monitoring. While these technologies enable automatic monitoring of road surface conditions, most of them are limited in coverage (i.e., they provide either spatial or temporal coverage, but not both) or in completeness (i.e., they provide only partial description of road surface conditions). There is therefore a need to make inference on road surface conditions based on data of one or a few partial condition measures. Inferring road surface contaminants based on friction is particularly challenging because friction is influenced not only by road surface contaminants but also by other factors such as the characteristics of the pavement material. Furthermore, different types of contaminants could correspond to a similar level of friction due to other confounding environmental factors. In this research, we investigated the patterns of friction and other condition variables under different types of road surface contaminants and developed a multinomial logistic model to relate the probability for a road surface being covered by a given type of contaminants to friction measurements and other available data. The analysis is based on a set of field data collected by the Ontario, Canada, Ministry of Transportation, including concurrent observations of temperature, video images of surface state, and friction. This presentation focuses particularly on how to improve the fitness of the models through spatial aggregation of friction data. The models are evaluated using holdout data and applied to estimate snow coverage of a maintenance route during a snow storm.

ROLE OF SURFACE FRICTION IN WINTER MAINTENANCE

A Feasibility Study on Friction for Winter Road Management**ROBERTO A. TOKUNAGA****MAKOTO FUNAHASHI****NAOTO TAKAHASHI****MOTOKI ASANO***Civil Engineering Research Institute for Cold Region*

Currently in Japan, winter road conditions are visually evaluated and categorized for snow and ice control operation. This visual determination, however, lacks accuracy due to its vulnerability to winter maintenance personnel's individual variations in experience and subjectivity. Therefore, since this subjective measure could result in overapplication of material and areas in need of attention being left untreated, errors during the visual determination compromise the efficiency and effectiveness of the implemented treatment. Alternatively, the evaluation using friction values is anticipated to objectively identify areas in need of treatment, pinpoint slippery sections requiring special attention, quantify the appropriate amount of material to be spread, and accurately evaluate the effectiveness of spreading anti-icing agents and abrasive materials. This study explores the feasibility of implementing a friction measurement evaluation system in Japan as a tool to evaluate road condition objectively and quantitatively. Specifically, with a continuous friction-measuring device that can determine the surface friction of an extended section of road as a line the study tests for obtained data's accuracy and reliability as well as suitability for the snow and ice control management. This paper presents a summary of results obtained from these studies to suggest some ideas for the local road administrators to promote effective and efficient snow and ice control management.

In a cold, snowy region such as Hokkaido, Japan, with winter comes the potential for icy, slippery roadways, and snowfall and snow accumulation leading to narrowed roads. These winter conditions result in negatively affecting winter travel. Especially since the use of studded tires was regulated in the early 1990s, extraordinary slippery roadways can be seen more often. Under such situations, road authorities have developed and implemented a variety of practices and techniques, such as snow removal and spreading materials to treat icy surfaces, for better snow and ice control to minimize winter hazards and make travel safer and more reliable. However, while the snow and ice control budget has limitations, it is required to promote more effective and efficient snow and ice control activities.

It is important to determine road condition to effectively conduct snow and ice control operations, which could reduce costs, increase safety, and improve mobility. However, winter road surface conditions are complicated to understand because of changes in surface conditions due to road-related structures such as bridges and tunnels, environment along roadways, weather, and the increased occurrence of extremely slippery surfaces due to the regulation of studded tires. Therefore, appropriate determination of road surface conditions is an important theme for winter road management.

Currently in Japan, winter road surface conditions are visually evaluated and categorized for snow and ice control operation. This visual determination, however, lacks accuracy due to its

vulnerability to winter maintenance personnel's individual variations in experience and subjectivity; in other words, the visual determination leads to different evaluation result from person to person. Indeed, in the 2005–2006 winter season, our research group examined how difference between visual determination and objective measure using the friction tester. As shown in Figure 1, there are some points that the friction tester shows lower values, which might be snow-icy roadway, while the visual determination recognize non-snow-icy roadway. Besides, the study recognized that in some points person tends to determine snow-icy roadway while the tester indicated higher friction values, which means dry-wet roadways. Then, this subjective measure could result in overapplication of material or areas in need of attention being left untreated. Otherwise, errors during the visual determination compromise the efficiency and effectiveness of the implemented treatment.

Looking for better ways to control snow and ice on roadways in Hokkaido, our research group directs its attention to friction value of road surface, which is already being applied into winter management in some regions of Europe and North America. This study explores the feasibility of implementing a friction measurement evaluation system in Japan as a tool to determine and evaluate road surface condition objectively and quantitatively. Specifically, with a continuous friction measuring device, which can determine the surface friction of an extended section of road as a line, the study measures friction values of actual road surface conditions and tests for obtained data's accuracy and reliability as well as suitability for the snow and ice control management. This paper presents a summary of results obtained from these studies to suggest some ideas for the local road administrators to promote effective and efficient snow and ice control management.

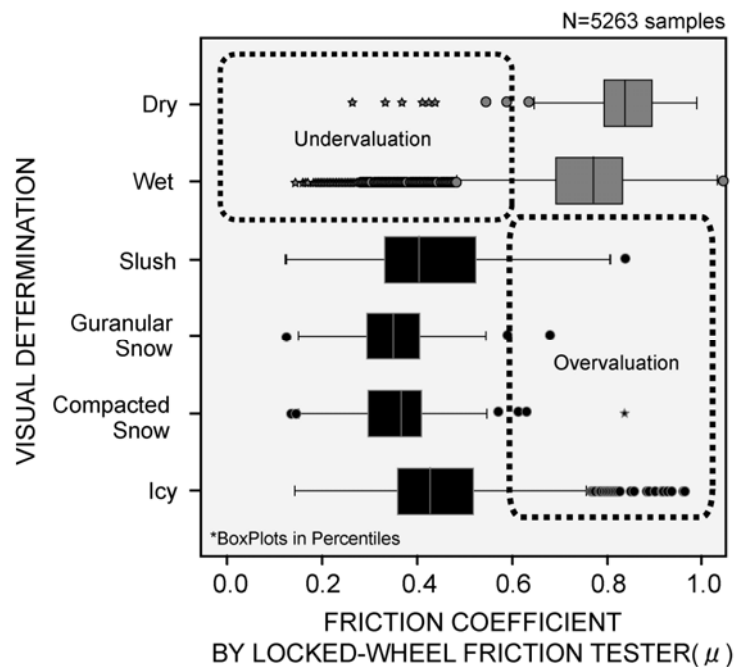

FIGURE 1 Deviation between visual determination and friction coefficient.

SUMMARY OF CONTINUOUS FRICTION TESTER

In Japan, road authorities apply the bus-typed locked-wheel friction tester as the standard tester (Figure 2), and, in other countries, especially in northern Europe, the device measuring the deceleration of the vehicle, called a decelerometer, is more common. These devices measure friction resistance by forcing to lock the test tire in the case of the locked-wheel tester or applying the brake suddenly in the case of the decelerometer. However, these methods of measurement are limited to recording data at specific points, thereby making it difficult to determine the change of friction resistance on a route as a whole.

In 2006, our research group introduced a device to measure friction value on roadways continuously in real time (Figure 3). In the United States, some road authorities have practically used this device to measure friction value on winter roadways. Besides, in the case of Ohio Department of Transportation (DOT), the device is used not only to measure road surface grip but also to apply the device, which is installed in the lower part of the truck for anti-icing operations, as a sensor to determine whether to distribute anti-icing materials (Figure 4).

This device calculates friction value by measuring the axial force created by installing a test tire 1 to 2 degrees off axis from the direction of travel, as shown in Figure 5. The friction value computed by the tester is called Halliday friction number (HFN), which is originally determined by this device's designer, and this HFN scale usually varies in 0 to 100.



FIGURE 2 Bus-typed locked-wheel friction tester.



FIGURE 3 Continuous friction tester.



FIGURE 4 Anti-icing operation vehicle with continuous friction tester (Ohio DOT).

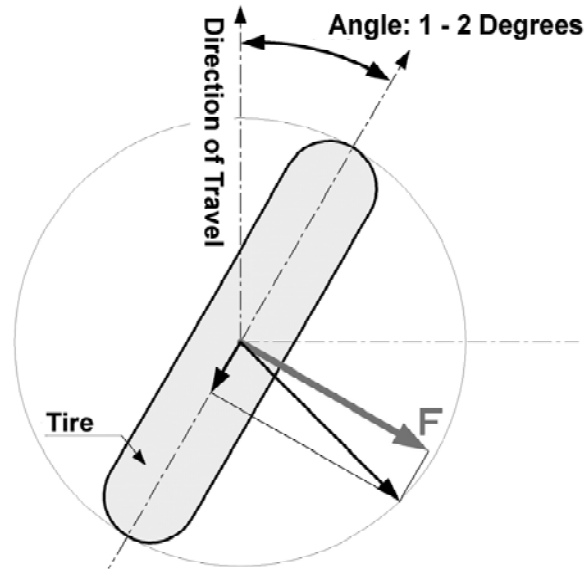

FIGURE 5 Principle of measurement.

As shown in Figure 6, there is linear relationship between the HFN value and the axial force, and the value shows lower while the side force is lower. HFN is defined as 0 when there is no force between the tire and the road, and as 100 with side force between the tire and the road when the tire is being run on dried pavement (this value of 100 can be for a road at 0°C).

On the other hand, this device heavily depends on the steering angle of the vehicle. Therefore, if the angle of steering goes beyond a certain range, the measured friction value is influenced as the angle of the test tire becomes wider in relation to the direction of travel. Otherwise, the increased angle of the tire greatly changes the friction resistance values even if the surface conditions remain the same throughout a curve section, for instance. Accordingly, in order to prevent that the operator of a winter maintenance vehicle misunderstand the measurement value, the system has a function which not displayed the value while setting the specific steering angle as the trigger value. The trigger value can be set up in the range to a maximum of 30 degrees either side, but its recommended range is less than 7 degrees.

This measuring device does not require braking of the test tire, thereby making it possible to continuously measure surface friction resistance values. Another advantage is that the vehicle does not require any special operation while measuring, although caution is required with regard to steering. Moreover, as shown in Figure 7, the measured friction value can be confirmed in real time in the vehicle, and can also be recorded on the external recording equipment, such as a personal computer.

COMPARISON STUDY WITH JAPAN'S STANDARD DEVICE

During the 2006–2007 winter season, our research group conducted the comparison study of two friction testers: Japanese standard (bus-typed) locked-wheel friction tester and continuous

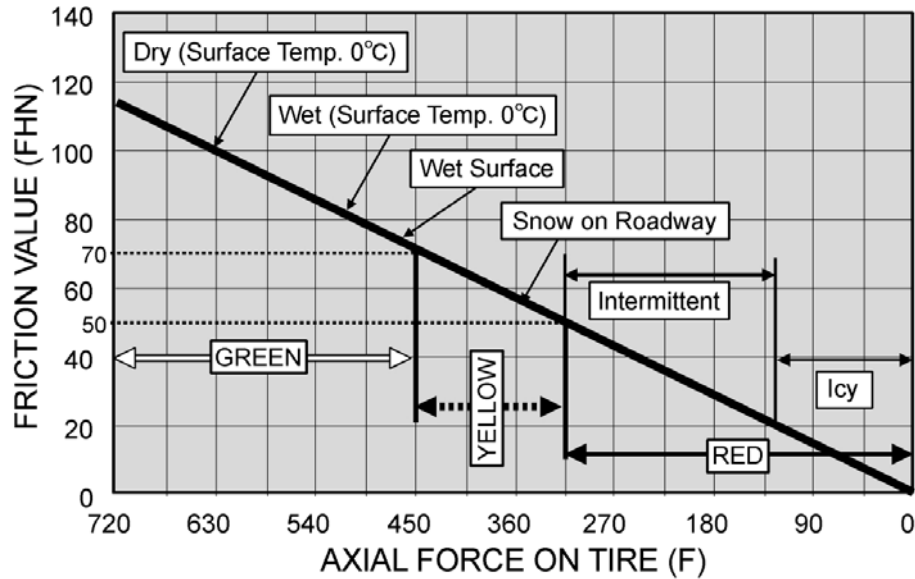

FIGURE 6 Relationship between friction value and axial force.

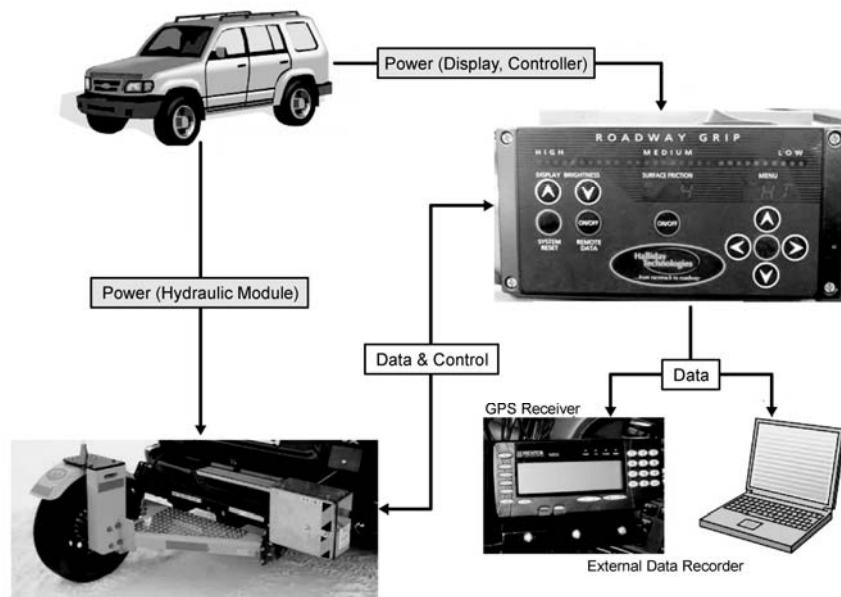

FIGURE 7 Architecture of data collection system by continuous friction tester.

friction tester. Wet and icy surfaces were artificially placed on the test courses (Figure 8) and the friction resistance was measured with each of the test vehicles. The testing speed for the locked-wheel tester was set at 40 km/h while for the continuous friction tester was 20, 40, and 60 km/h. The testing was completed first with the continuous friction tester, and second with the locked-

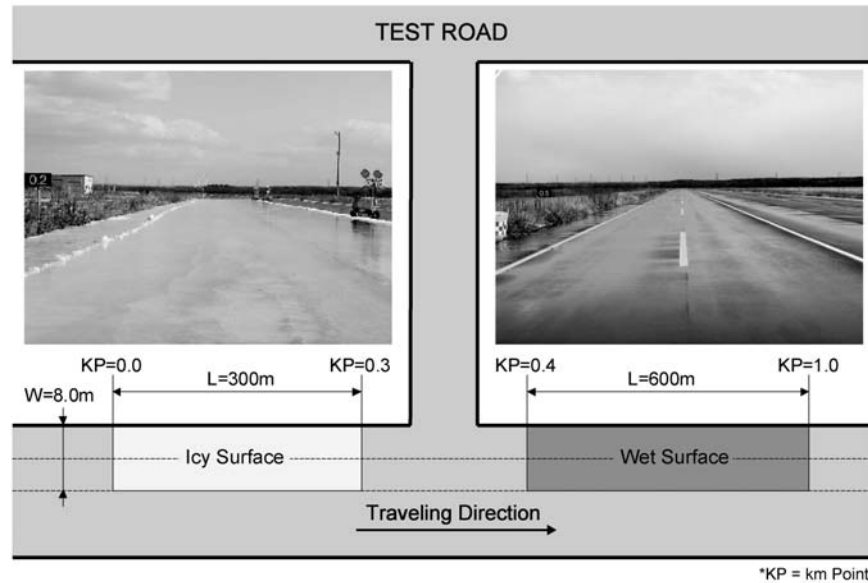

FIGURE 8 Test course overview.

wheel friction tester, and each surface was measured 10 times. The air temperature was $-1\sim 5^{\circ}\text{C}$, and the road surface temperature was $-3\sim 7^{\circ}\text{C}$ on the day of the testing. For the purposes of this test, an attempt was made to recreate a naturally wet road surface by spreading water onto dry pavement one or two times using a water sprinkler, though this is different from a wet surface in the strict sense of the term.

Figure 9 shows the test results, and while the vertical axis shows the friction coefficient measured by the locked-wheel friction tester, and the horizontal axis shows the friction resistance values measured by the continuous friction tester. When diagonal data is plotted on the graph, it means that it has a 1:1 correlation to the locked-wheel friction tester. In addition, a regression line is drawn with the assumption that there is a linear relationship between each of the vehicles. From this figure, surface conditions can be distinguished because the friction resistance values recorded by both test vehicles follow the same distinct pattern. Besides, because of regression analysis, it demonstrates a large linear correlation value of 0.9. Thus, it is clear that both test vehicles have a strong correlation relationship, confirming that each of these can be used as an accurate means for measuring the slipperiness of snowy-icy surfaces for winter road management.

This comparison study was tested under specific conditions: icy and wet surfaces. Otherwise, in the near future, more data need to be accumulated for surfaces such as compacted snow and slushy conditions. However, the test results identify a high correlation between the locked-wheel friction tester and continuous friction tester. Furthermore, even if it changed tester's measurement speed, its friction value was not negatively influenced. Therefore, it is expected that the continuous friction tester can be highly introduced for its practical use as the approach of understanding objective and quantitatively winter road surface condition.

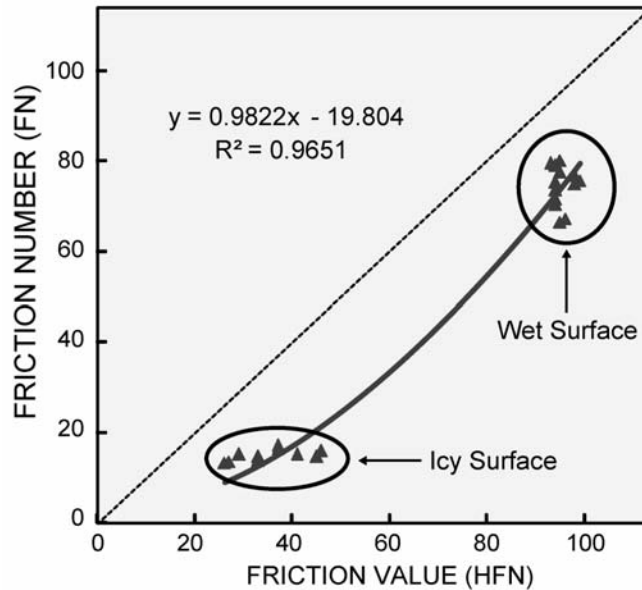

FIGURE 9 Test results (locked-wheel tester versus continuous friction tester).

UNDERSTANDING OF ROAD SURFACE CONDITION IN ACTUAL ROADWAY

In the 2006–2007 winter season, our research group examined road surface conditions of actual roadways with using the continuous friction tester (Figure 10). The selected roadway for this case study is the national highway Route 5 and 274, which run through the City of Sapporo. The length of the study route is about 42 km, and the measurement was conducted for 10 days. At the same time, in order to explore how the difference in road surface condition impacts on vehicle's travel speed and acceleration–deceleration, the study also measures travel speed and acceleration–deceleration in the roadway, using the test vehicle installed with the decelerometer (Figure 11).

Figures 12 and 13 shows the road surface condition (friction value) measured by the continuous friction tester and the deceleration at the time of stop at the signal intersection measured by the decelerometer test vehicle, according to snowfall or non-snowfall day. The friction value by the continuous friction tester is shown by the value averaged the data recorded with the sampling rate for 0.1 s for every definite interval.

On December 27, with no snowfall, the averaged friction value shows relatively high (HFN = 88), and it means that the road condition could be dry (Figure 12). However, as the HFN data at some bridges and intersections shows less than 50, the study recognized that there are some slippery points within the roadway. On the other hand, on February 15 with snowfall, the averaged friction value though the entire route shows snow–icy road condition (HFN = 35). Moreover, the data by the decelerometer shows that both average travel speed and deceleration at the time of snow–icy roadway decrease remarkably, compared with those at dry surface. This means that the slipperiness of road surface could affect the performance of vehicle passing through the selected route. Figures 14 and 15 shows the average travel speed and the deceleration at the intersection under the same condition with Figure 12 and 13.



FIGURE 10 Examination of road condition by continuous friction tester.

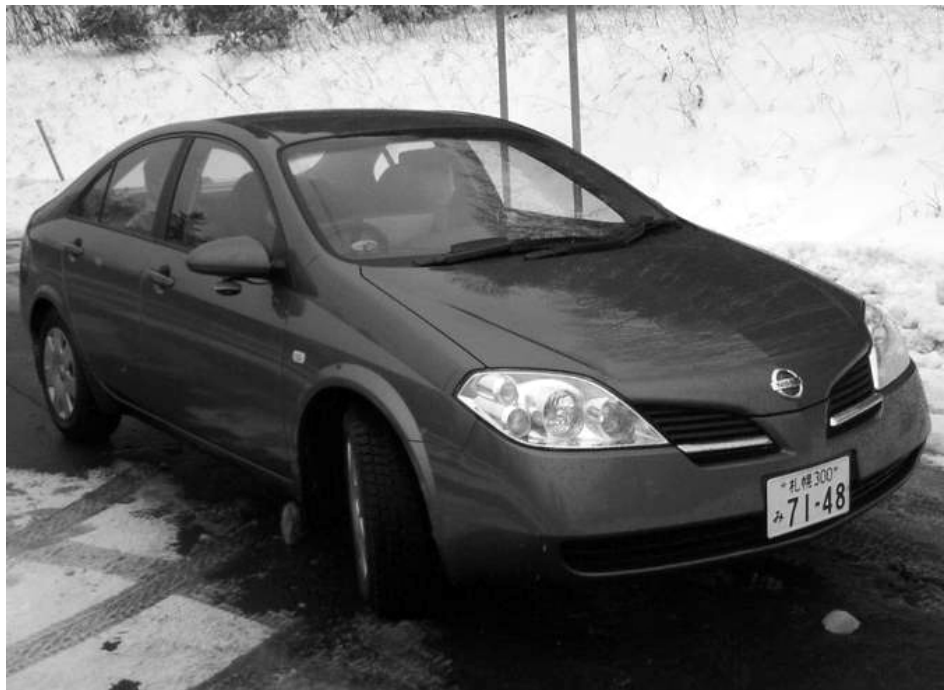

FIGURE 11 Test vehicle with vehicle performance measuring unit (decelerometer).

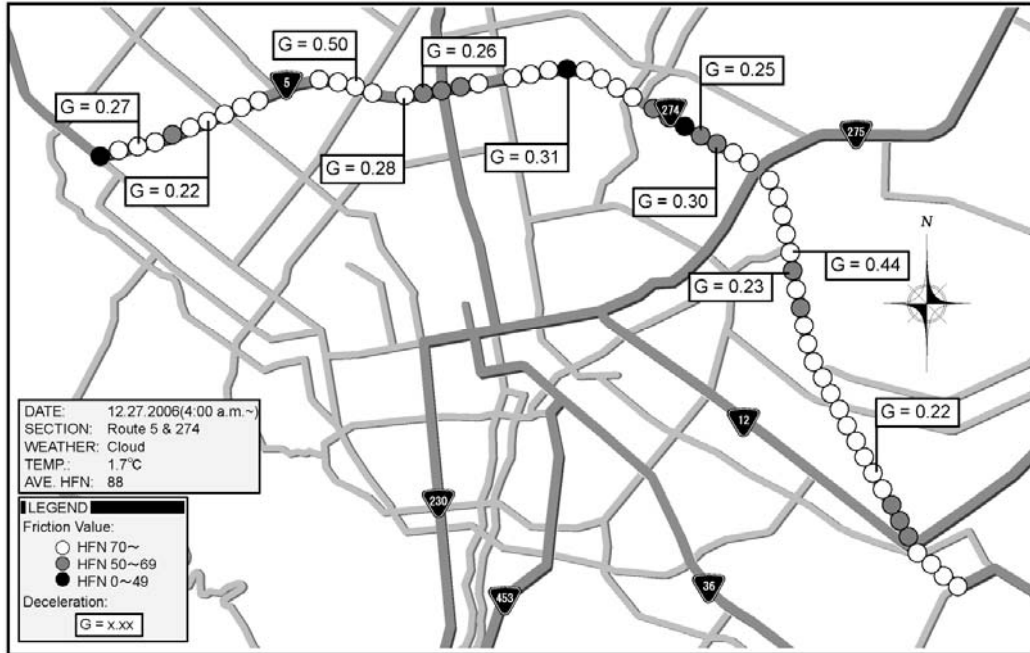

FIGURE 12 Road condition (friction value) and deceleration: cloud.

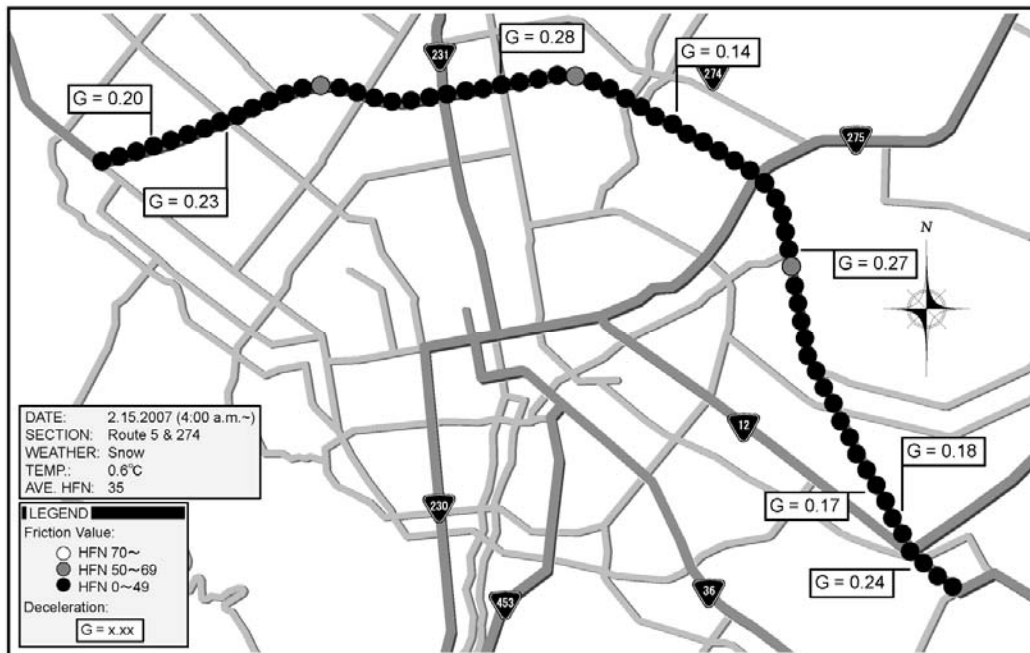

FIGURE 13 Road condition (friction value) and deceleration: snow.

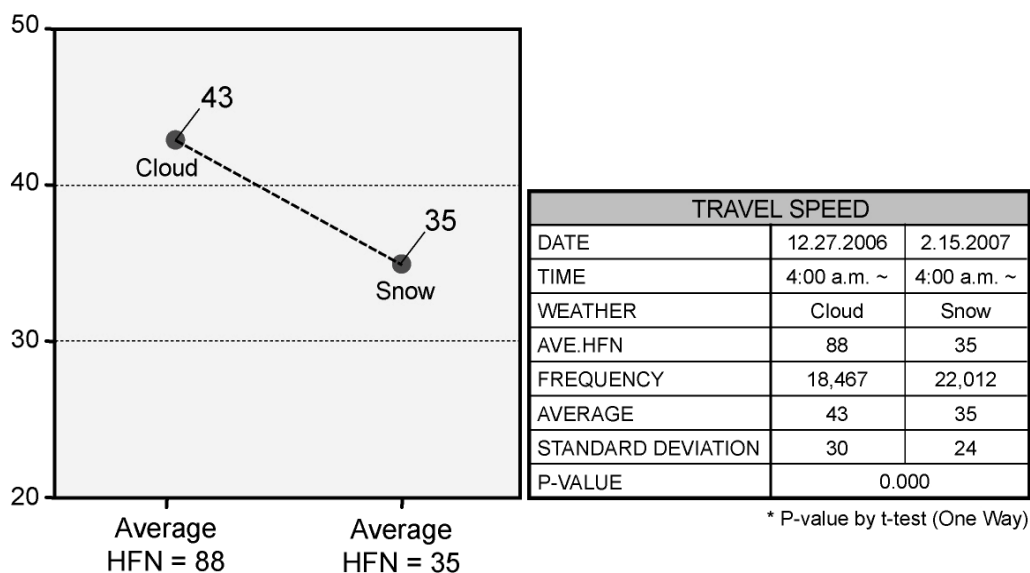

FIGURE 14 Average travel speed according to different road condition.

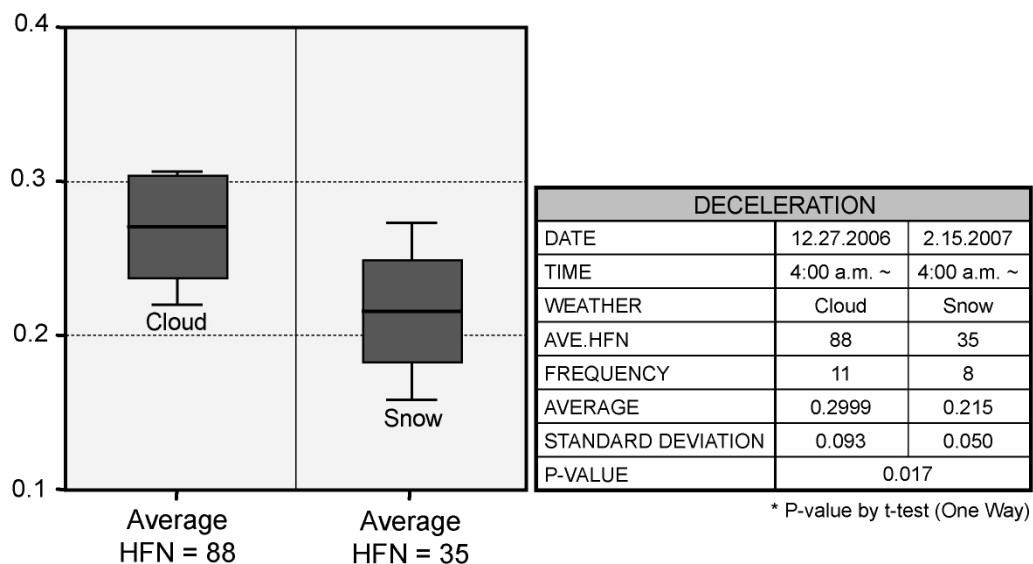

FIGURE 15 Deceleration according to different road condition.

As a result, the study finds that it is possible to identify quantitatively and continuously whether roadway is snowy-icy or not, or change of road surface condition by time progress by using the continuous friction tester. Besides, the study performs a basic examination about the effect on the vehicles movement by change of friction value. Since such data can show the necessity and outcome of snow and ice control activity in detail and exactly, it can contribute to appropriate decision making for snow and ice control operation and understanding of its effect.

CONCLUSIONS

Throughout the course of this paper, we describes about the possibility of the quantitative evaluation approach of road surface condition with using the continuous friction tester. The result shows that friction value measured by the tester can identify and evaluate road surface condition quantitatively. In snow and ice control operation, it is possible to identify and evaluate winter road surface condition quantitatively and continuously; otherwise, it can contribute to prevent overapplication of material or areas in need of attention being left untreated. Moreover, by accumulating the data outputted from this device, it might play a role as an evaluation index to set goal of snow and ice control operation and to identify the effect of its treatment activity. Thereby, the technology of measuring the friction coefficient is anticipated to contribute developing further effective and efficient winter road management system based on the performance measurement approach.

In the future, our research group plans to suggest how friction value employs in the practical use with reviewing following points throughout the opinion exchange with road authorities and operators:

- Avoid overapplication of material or areas in need of attention being left untreated,
- Determine actual condition of snowy and icy surfaces, and
- Understand the effectiveness of spreading anti-icing materials.

Moreover, with applying the continuous friction tester, we promote to design and develop a “slip alert system” which utilized geographic information systems and the Internet while developing a method to predict slipperiness of winter roadway based on the relationship between friction value and weather forecast system–road surface condition prediction system.

RESOURCES

1. Hokkaido Development Bureau. *Winter Road Surface Management Manual*. Draft. Hokkaido Development Bureau, 1997 (in Japanese).
2. Al-Qadi, I. L., A. Loulizi, G. W. Flintsch, D. S. Roosevelt, R. Decker, J. C. Wambold, and W. A. Nixon. *NCHRP Web Document 53: Feasibility of Using Friction Indicators to Improve Winter Maintenance Operations and Mobility*. Transportation Research Board, National Research Council, Washington, D.C., 2002.
3. WisDOT Research and Communication Services Section. *Using Friction Measurements to Gauge Winter Maintenance Performance*. Wisconsin Department of Transportation, 2007. Available at www.dot.wisconsin.gov/library/research/docs/tsrs/tsrfrictionmeasurement.pdf.
4. Funahashi, M., R. A. Tokunaga, and M. Asano. Introduce of Continuous Friction Tester. *Monthly Report*, No.651, Civil Engineering Research Institute for Cold Region, 2007, pp. 40–47 (in Japanese).
5. Asano, M. Introduce of Management for Winter Road Maintenance. *YUKI*, No. 67, Snow Research Center, 2007, pp. 38–44 (in Japanese).

ROLE OF SURFACE FRICTION IN WINTER MAINTENANCE

Measurements of Pavement Condition and Road Weather Environment Within North Dakota Using a Tow-Hitch Mount Road Grip Tester

JEFFREY S. TILLEY

SCOTT S. KROEBER

JENNIFER GREEN

University of North Dakota

DIANA CLONCH

Ohio Department of Transportation

DON HALLIDAY

Halliday Technologies, Inc.

Each year, hundreds of accidents nationwide are reported that are attributable to a loss of vehicular traction. Many of these accidents are associated with snow and ice accumulation on roadways as a consequence of winter storms or by the formation of pavement frost or black ice during more quiescent weather regimes. A cooperative effort between the University of North Dakota, the Ohio Department of Transportation, Halliday Technologies, Inc., the Rural Geospatial Innovations program, and the Aurora Program was undertaken to collect data on road surface friction conditions utilizing a test research vehicle equipped with a tow-hitch mount road-grip test unit. The unit is mounted at an offset angle to the alignment of the remainder of the wheels on the research vehicle, thereby producing a net sideways drag force that varies with the amount of grip, which is a function of the pavement condition. A software console inside the vehicle provided road grip values at a 1 Hz frequency. Winter 2006–2007 measurements with the research vehicle involved two different measurement methodologies. This paper reports on real-time measurements on eastern North Dakota primary routes during winter weather events, utilizing an onboard Global Positioning System (GPS)–encoded video system for precise tracking and high-resolution visual characterization of the roadway environment. Also briefly discussed is a data fusion effort to utilize the road grip data, the GPS-encoded video, and onboard measurements of pavement and air temperature to obtain a more complete depiction of the wintertime road weather environment.

Each year, many highway accidents are attributable to adverse weather conditions. These accidents result in significant loss of life, injuries, reduced roadway capacity, increase in travel times, and slowdowns in shipping and commercial activity. In 2001 more than 1 million accidents could be related to wet, snow-covered, or icy pavement conditions (1). Further, in any given year, more than \$40 billion in damages are incurred through injuries, loss of life, and property damage alone from weather-related highway accidents (2), let alone billions in commercial and economic impacts. Clearly, it is within the local, state and national interest to take a proactive and aggressive approach to the management of weather impacts upon the nation's highway system.

Over the past decade, awareness of the serious nature of weather impacts to the roadway environment has led to workshops, symposia, research statements (3), the formation of research consortia, and a variety of new research initiatives by FHWA and other agencies, all with the goal of dramatically improving the response to weather impacts on the road environment. This paper reports on one of these efforts—tests conducted by the University of North Dakota (UND) Surface Transportation Weather Research Center (STWRC) of a unit designed to measure the degree of roadway traction, or grip, available on a given roadway surface in a real-time fashion [the RT3, formerly known as the RGT (4), developed by Halliday Technologies, Inc.]. This effort was a follow-up to previous work conducted by the Ohio Department of Transportation (ODOT) to evaluate the utility of the RT3 unit for use within ODOT winter maintenance management activities. In the following section we present a brief overview of the RT3 unit and the testing done by ODOT prior to this study.

DESCRIPTION OF THE RT3 UNIT

The operating principles of the RT3 unit are quite straightforward. The description presented here is a summary of that presented in a previous report (4).

Figure 1 illustrates the unit, which can be mounted via tow-hitch to the rear of a vehicle or underneath the vehicle in front of the drive axle. ODOT has utilized the latter configuration with snowplows and the former configuration for freeway patrol units, including the unit loaned to UND STWRC for this study. Further discussion of the RT3 in this section is limited to the tow-hitch mounted version.

The RT3 unit consists of a standard 15-in. auxiliary wheel along with a Halliday Technologies, Inc., GEM wheel hub, both attached to a fixed mechanical arm, connected to the tow hitch; that is, oriented at a 1.75-degree toe angle from the alignment of the other wheels on the vehicle. This toe angle (which is an optimal value based on testing discussed in the next section) allows for a electrical load cell within the GEM hub to measure a lateral force, relative to the direction of travel, based upon the relative degree of resistance—friction—provided to the tire mounted on the auxiliary wheel by the underlying road surface. The mechanical force is converted to an electrical signal, through a microprocessor and software algorithms within an accompanying console located in the cab of the vehicle (Figure 1), is translated from voltage into a normalized measure of friction, hereafter referred to as the Halliday Friction Number (HFN). HFN values are displayed numerically as well as visually through a predefined colored light system (green = high HFN; yellow = moderate; red = low).

PREVIOUS WORK

In late 2001, an RT3 unit was installed in a 1998 ODOT dump truck equipped with a ThomTech, Inc., Global Positioning System (GPS)—automated vehicle location (AVL) system, which allows for display of position and friction information on a customized web interface. ODOT began testing and refining this prototype RT3 in 2002, and in 2004 began testing tow-hitch RT3 units installed on pickup trucks utilized as road maintenance vehicles and freeway patrol vehicles. These units were operated continuously for 1 year to evaluate the durability of the equipment and instrumentation as well as the accuracy and repeatability of the collected data. Variables



FIGURE 1 Close-up view of (a) RT3 auxiliary wheel, GEM hub and tow hitch and (b) RT3 software console mounted in the research vehicle.

collected included date, time, speed, latitude, longitude, road temperature, air temperature, and HFN values. Over this year of testing, the RT3 performed well, returning consistent, repeatable results in both summer and winter (4).

In addition, summer testing took place in controlled environments at ODOT's Transportation Research Center and the Ohio State University (OSU) ice rink. At both locations, individual sections of like pavement surface were utilized for repeatability and accuracy testing. Numerous HFN observations, along with surface condition (wet or dry), pavement temperature, tire pressure, and tread depth, were collected. Results from the summer tests found the units to be durable and dependable. During the 2004–2005 winter measurements to validate the durability, consistency, and accuracy of the units were made throughout Ohio. Photographs were included as visual documentation of measured conditions and were combined with mapping and graphing techniques to provide a representation of actual conditions. Reported HFN values consistently and accurately reflected the pavement conditions (4).

However, winter conditions in Ohio during the 2002–2005 period were relatively benign compared to what is typical for the state (5). A more severe winter weather environment, such as that found in eastern North Dakota, was deemed desirable for conducting further tests of the RT3 unit in order to demonstrate continued reliability, accuracy, and representativeness under more extreme winter conditions. The remainder of this paper details the work conducted under this follow-up study, using a truck and RT3 unit on loan to UND from ODOT.

METHODOLOGY

Study Domain and Period

The focus of this study was the 2006–2007 winter season (November 2006 to April 2007). The primary areas for data collection were segments of two eastern North Dakota routes, Interstate 29 (I-29) and U.S. Highway 2 (US-2), extending southward and westward from Grand Forks, North Dakota, respectively (Figure 2). The choice of these route segments was motivated by the fact that these segments coincide with test routes for the FHWA maintenance decision support

system (MDSS) and other STWRC research activities, allowing for leveraging of resources for the project.

Controlled experimental tests were also performed at the UND STWRC Road Weather Field Research Facility near the southern terminus of the I-29 segment. However, at the facility, the straight-line segments, which are colocated with verifying in situ and remote sensors, are quite short (~15 to 35 m), and it was difficult to obtain a statistically significant data sample to use for comparison with the longer ODOT and OSU test segments noted in the previous section. As such, the remainder of this paper will discuss only measurements conducted in the context of real-time field tests on I-29 and US-2.

Measurement Platforms

ODOT Pickup and Associated RT3 Unit

The research platform used in the study was a Ford F150 long-bed 4x4 pickup with an attached tow-hitch RT3 unit. The pickup and RT3 unit were loaned to UND for the duration of the project. This particular pickup and RT3 unit participated in the previous ODOT testing cycles, thus allowing direct comparison of this study with results obtained in Ohio. The Ford pickup was also equipped with pavement and air temperature sensors (described in the following subsection), the same Bridgestone Insignia P205-R65 Mud and Snow tire, and the same ballast weight (~115 kg) used in the Ohio testing. The Bridgestone tire, though not new, had relatively little wear upon its arrival in North Dakota and was maintained at a pressure of 30 psi (2 kg/cm). These parameters translate to ~50 kg of side load on the tire for dry pavement conditions.

The RT3 unit provides information from the load cell at a frequency of 100 Hz. The in-cab console provides several options for data retrieval—display at rates ranging from 10 Hz to 0.1 Hz. In order to align all of the data outputs easily, for this study to a 1 Hz data output frequency



FIGURE 2 Domain of study during winter 2006–2007; 25-mi segment in red is US-2, extending west from Grand Forks and 20-mi segment in blue is I-29 south from Grand Forks.

was utilized; at this frequency 100 HFN values from the load cell are averaged to provide a 1 Hz value that is displayed and archived either via a local laptop, a ThomTech, Inc., AVL system, or both. This averaging provides for a spatial resolution ranging from ~36 ft (11 m) at 25 mph to ~81 ft (24.8 m) at 55 mph—the range of speeds considered for the bulk of the measurements presented in this paper.

For the data presented in this paper, a Dell laptop was utilized as a data archival platform in addition to the ThomTech AVL unit briefly described below. The laptop connects to the RT3 console unit through a modem-type connector that required the use of the laptop's serial port. Once connected, the Microsoft Windows Hyperterminal utility is used to collect and archive the RT3 datastream. Only five fields—time (relative, not UTC), vehicle speed, vehicle direction, HFN, and a steering parameter—can be archived in this fashion.

Pavement and Air Temperature Sensors

The pavement and air temperature sensors utilized on the ODOT pickup comprised a Commercial Vehicle Group RoadwatchSS™ system, illustrated in Figure 3 in an unmounted configuration. The pavement temperature sensor is an infrared remote sensor with approximately 0.5 s response time. The air temperature sensor is a more traditional thermistor type with similar response characteristics. Both sensors are mounted at midcab height on the driver's side of the ODOT pickup, providing air temperature information valid at ~1 m above ground level. For our purposes, this sensor package provided pavement and air temperature data at sufficient resolution to be consistent with the RedHen GPS-Video and RT3 datastream sampling frequencies.



FIGURE 3 Roadwatch SS system utilized in the study.

RedHen GPS-Video System

Given the ability to simultaneously measure roadway traction, pavement temperature, and air temperature at relatively high frequencies (~1 Hz), along with the ability to have geographic information recorded at approximately similar frequency via the ThomTech AVL, it became clear that a collaboration of this study with ongoing UND geospatial data information projects would provide a leveraging opportunity to better document the roadway weather environment, including fine-scale variability in pavement conditions (<30-m resolution) related to geospatial factors and microscale variability in blowing and drifting snow. Further, video records could provide an important source of verification for the HFN observations. As such, the real-time field observations considered in this paper also include video datastreams encoded with GPS information using a RedHen GPS–video system. This system, which is pictured in Figure 4, collects video data along with geospatial data and voice recordings on the audio channels of the video recording device; in this study the video recording device was a Sony DVD–video recorder (not shown).

Latitude, longitude, and altitude (elevation) values are sampled at an interval of approximately once per second with accuracy to thousandths of a degree. This allows each point to be attributed with a course direction and speed value. Since the unit uses GPS to create the geospatial data an accurate time stamp is also associated with each point. The unit also has the ability to insert a feature point within the dataset with the push of a button. This ability was used repeatedly in the analysis to assist in isolating areas where transitions in pavement condition were found.

ThomTech GPS–AVL System

As noted above, a GPS–AVL system from ThomTech, Inc. was installed in the ODOT pickup used in the study. This system uses a satellite modem uplink to transmit information from the RT3 and RoadWatch SS sensors, as well as latitude, longitude, vehicle speed, vehicle direction,



FIGURE 4 Front and rear views of RedHen GPS–video unit. Input and output ports for a laptop, GPS antenna, telephone, microphone, and video camera are shown.

and other information back to a database server located at ThomTech's facilities in Minneapolis, Minnesota. The information was available to selected UND and ODOT personnel in near-real time at an internal ThomTech website, and could be manipulated via a graphical user interface (GUI) geospatial interface. Unfortunately, problems with the satellite uplink and database server limited the utility of this resource for some of the data collection periods. As such, the results presented below reflect the use of both the ThomTech system and the onboard laptop–RedHen system for geospatial referencing.

Experiment Design

Events

In this paper we consider observations from a total of nine measurement days with reliable, RT3, RedHen, and video information. These days were as follows:

- November 20, 2006;
- December 29, 2006;
- December 31, 2006;
- January 27, 2007;
- February 25, 2007;
- March 1, 2007;
- March 2, 2007;
- March 6, 2007; and
- March 15, 2007.

This is a subset of the total amount of data collected. In addition to the routes noted above, during the January 27 event, observations were taken along a two-lane asphalt highway that parallels I-29 between Grand Forks and Fargo. The total sample size is over 35,000 observations. More detailed information on the events, including variations in weather conditions for each event will be given in a future presentation.

Measurement Strategy

Observations were generally taken at highway speeds (50 to 55 mph/80 to 88 km/h), but during some events, environmental conditions, including visibility, traffic, degree of blowing snow, strong winds, and amount of snow and ice on the roadway dictated slower speeds from a safety standpoint. As such, vehicular speed becomes an independent variable in the analysis. In an attempt to mitigate any spurious influences from vehicular speed, observations were taken with speed approximately constant when safety considerations permitted. Analysis of speed effects is thereby included in the overall data analysis.

Data Analysis Procedures

Event Aggregation and Segregation

Our analysis examined the available data from both macroscopic and microscopic points of view; that is, we examined trends over all events combined, performed detailed individual case studies, and aggregated the events in different ways in order to examine the impacts of individual influences. Our overriding goal was to consider all the possible factors that could potentially influence the observed HFN values, and systematically attempt to eliminate those factors such that the pavement condition alone remained as the factor that the RT3 was responding to. Validation was performed by merging the RT3, air temperature, pavement temperature and RedHen GPS–video datastreams to determine if the variability in the measured variables was consistent with the video record.

We have analyzed the influence of the following factors on the HFN observed values: pavement temperature, air temperature, vehicle speed, vehicle heading (mostly an issue when strong winds provided a lateral force against the vehicle), road segment pavement type, and changes in many of these variables. Because we did not have a second vehicle/RT3 unit available to provide a comparison of the influence of data output rates (and the different inherent averaging that would occur in the data by the RT3 software), we have also computed running averages of the data as one means of evaluating this effect. Descriptions of the averaging and outlier removal procedures as well as the merging of datastreams are provided in the following subsections.

When segregating the data by different segments of roadway (e.g., eastbound versus westbound US-2), the data were first separated into separate events and then sorted by time. Verbal and written notes on each event, video from the RedHen GPS–Video datastream, and vehicle speed and heading observations were used to properly stratify data into the different roadway segment. Due to the fact that one segment is east-west oriented and the other is north-south oriented this was generally a straightforward procedure. Segregation of the data by pavement type was somewhat less straightforward and will be discussed in the context of merging of the datastreams.

Averaging, Outlier, and Data Fitting Procedures

Averaging Scheme In all averaging procedures, we assumed a 2-s frequency for observations. This is done to standardize the data intervals, as we found that, particularly relative to the ThomTech datastream, data transmission–archival frequencies were not strictly constant, and therefore some standardization in the data frequencies had to be made. Such standardization had the side benefit of acting as a moderate low-pass filter to smooth out the highest frequency noise, some of which we found was caused by highly localized pavement irregularities on both I-29 and US-2.

Two different types of average (strictly, running average) values were calculated: a centered 10-s average and a forward 8-s average. The 10-s centered average utilizes the two previous HFN observations, the current time's HFN observation and the next two future HFN observations to calculate the averaged value valid at the current time. The forward 8-s average utilizes the current HFN observation and the next three future HFN observations to calculate the

average value valid at the current time. In general, both averaging schemes smoothed the data while still keeping the trends on timescales on the order of 30 s and greater.

Outlier Criteria In the context of this analysis, outliers were defined as data values more than two standard deviations outside the mean value. The outlier criteria were slightly rounded up or down from their exact values in accordance with the resolution of the instrumentation recording the variable in question. Any data that met the outlier criterion for road grip, vehicle speed and pavement temperature were removed. Outlier criteria were not computed for vehicle heading as there are a few broad curves in the road segments traveled, thereby skewing the distribution of vehicle headings somewhat from the general quadpolar (N, S, E, W) distribution expected for the primary road segments in question.

Data Fitting Both linear and 2nd-degree polynomial curves were fit to the data using standard spreadsheet software that applies least-squares type linear and quadratic curve fitting algorithms to scatter diagrams. The outlier criteria noted above were applied to plots where the linear and 2nd degree curves fit the data poorly and where obvious outliers were seen. In some instances this procedure resulted in slightly better fits to the data, but in many instances the improvement was minor.

Merging of Datastreams and Stratification by Pavement Type

As noted previously, a Dell laptop system was used as a secondary data collection–archival platform. Given the previously noted issues with the ThomTech AVL system, this secondary platform proved valuable, and in some cases, superior, to the primary AVL platform; typically, there was less data dropout with the Dell laptop Hyperterminal collection than with the ThomTech system. The weakness associated with the laptop archival, however, was that geospatial data were not included as an integral part of the datastream. To effectively use the laptop datastream, we needed to develop a procedure to merge two autonomous datastreams (the RT3 laptop data and the RedHen GPS–video datastreams), each having incomplete information relating to the observations taken.

The key to the merging procedure was to use time as the common attribute. We utilized the RedHen video mapping system’s capability to record voice notes, along with the feature point insertion button and a secondary GPS unit (a Garmin handheld GPS device) to closely synchronize the time attribute recorded on the RedHen system with the HyperTerminal time stamp. In doing so, we assumed that the RT3 unit and the RedHen system were located in sufficient proximity such that both units are contained within the same GPS point location (and thus geospatially colocated) when the data is collected. Therefore, time attributes from the two systems can be mapped to each other in a unique one-to-one sense.

Time periods of 1 min were utilized in the synchronization process. As a full minute elapsed on the Garmin GPS, the time would be spoken so that it was recorded onto the audio channel of the RedHen; simultaneously, the feature point insertion button on the RedHen unit was pushed and the most recent time stamp from the HyperTerminal output noted on the RedHen audio channel. With all of this information available at a fixed point in time, the offset between the actual time in UTC and the relative time recorded on the laptop HyperTerminal can be computed. Since both data sets then have their times synchronized, it is straightforward to merge the two datasets into one, allowing for association of the visual roadway environment conditions

with the corresponding HFN, air and pavement temperature, and vehicle heading–speed observations. This association provides for a visual method of verification and validation with the aid of geographic information systems software obtained from the Environmental Systems Research Institute.

SUMMARY OF RESULTS AND DISCUSSION

Space limitations prevent a full presentation of our results in this paper. In this section we provide a brief sample of the available results at this time. Additional aspects of this study will be presented in future articles and presentations.

Summary for Winter 2006–2007

Figure 5 presents a scatter plot of the bulk relationship between the RT3 HFN observations and vehicle speed. In this figure, the following data points are not included due to their lack of relevance in the analysis:

- Data points where the vehicle speed is less than approximately 10 mph (i.e., either the vehicle was stopped, slowing, or accelerating from a stop);
- Isolated data points where excessive speed (>56 mph) was indicated—again, this indicates a period of acceleration and brief overshooting of the 55-mph target speed occasionally occurred; and
- Outliers as defined in the previous section.

The number of points excluded for the second condition was negligible; the numbers were more significant (combined ~8% to 10% of the total) for the other two categories. Many, but not all, of the outlier values were recorded during turns from one direction to another, often at relatively low speeds. These data correspond, for the most part, to the transitions between one directional segment and the following segment.

We found the strongest relationships between the HFN values and not only vehicle speed, but also pavement temperature (not shown). The vehicle speed relationship is positive while the pavement temperature relationship is negative. However, as suggested by Figure 5 (similar results are found for pavement temperature), the scatter plot suggests that the relationship is rather weak, with considerable scatter around the best-fit trend line and parabolic curve. Similar results were found whether or not the averaged data was used, though for this latter case correlation coefficients were slightly higher. The weak positive relationship with speed is consistent with the summertime NASA runway friction workshop results (not shown), as well as other testing performed in Ohio (6). The slight negative relationship with pavement temperature may reflect a tendency for more slippery conditions at temperatures just below freezing, or may reflect the effect of low temperature on the rubber of the tire; further analysis is needed before a definitive conclusion can be reached.

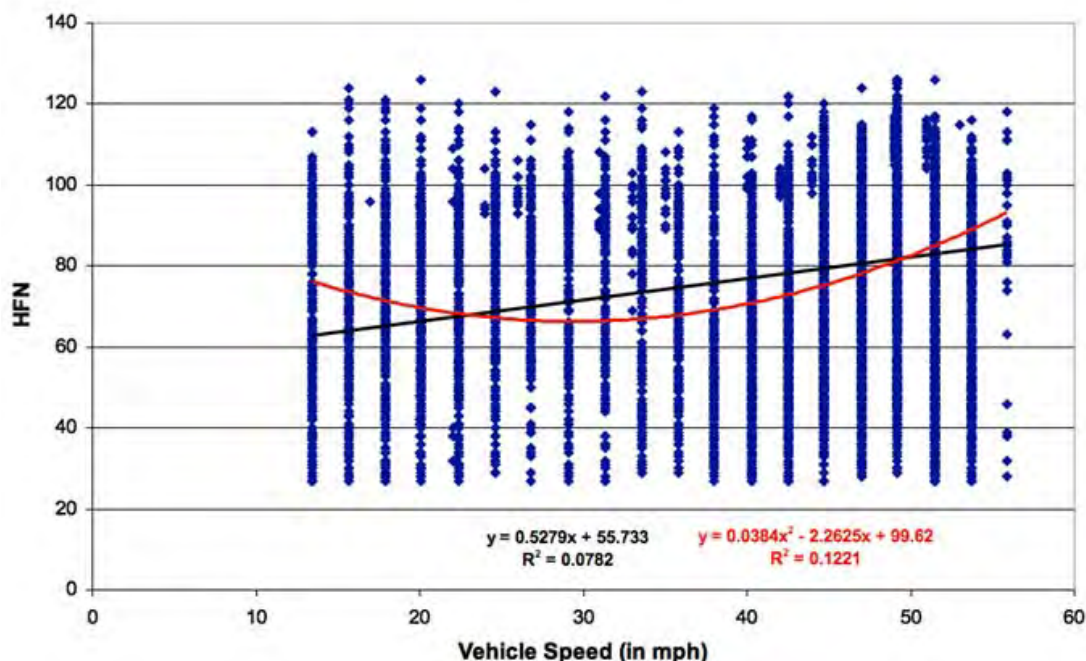

FIGURE 5 Scatter plot for HFN values and vehicle speed for all events listed during the 2006–2007 winter season. Heavy black line indicates best linear fit to the data; heavy red line indicates best parabolic fit. Regression formulas and associated correlation coefficients also are shown.

Aggregation by Route

The above results do not take into account various route-related factors that could impact the results. In particular, I-29 has higher daily traffic volumes than US-2 [140% higher in total traffic, 300% higher in commercial truck traffic (7) and thus will respond differently to a given weather scenario, all other factors being equal]. Different materials for each route may also play a role as well as the lane sampled (driving versus passing lane, both were sampled for most events). Pavement material effects will be examined in the following subsection; the effects of lane will be presented in a future paper.

Figures 6 and 7 show, for all events, the relationships between HFN values, and vehicle speed for the westbound US-2 and Northbound I-29 road segments, respectively. Both figures show significant scatter, as was the case for the aggregate over all road segments shown in Figure 5. However, the relationship for westbound US-2 is a substantially stronger one (based on the regression correlation coefficient) than for northbound I-29. A similar conclusion could be drawn based on examining eastbound US-2 and southbound I-29 segments (not shown). Some of this relationship, however, has confounding influences: with less traffic and less maintenance within the western half of the US-2 corridor (based on our own observations), the greater snow and ice cover on the roadway required us to reduce speed for safety reasons. Thus, for locations where HFNs would be lower due to snow and ice cover, our speeds were systematically lower; the lower HFN values cannot then, be simply attributed to an intrinsic property of the RT3 unit.

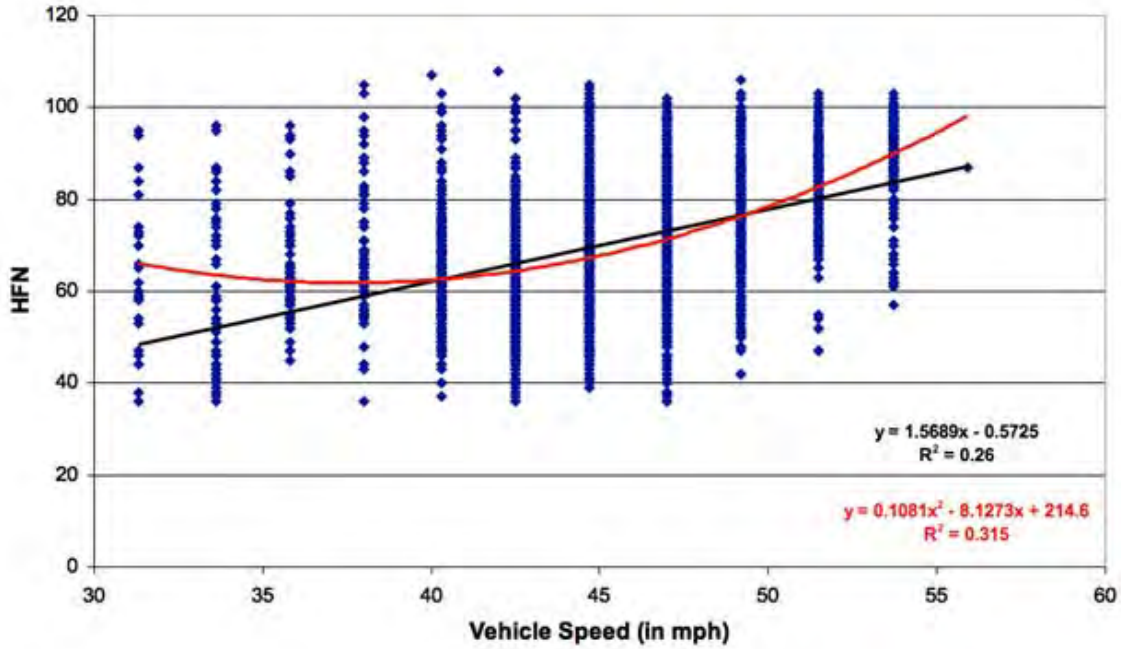

FIGURE 6 Scatter plot for HFN values and vehicle speed for all events during the 2006–2007 winter season, restricted to westbound US-2 road segments. Conventions follow those of Figure 5.

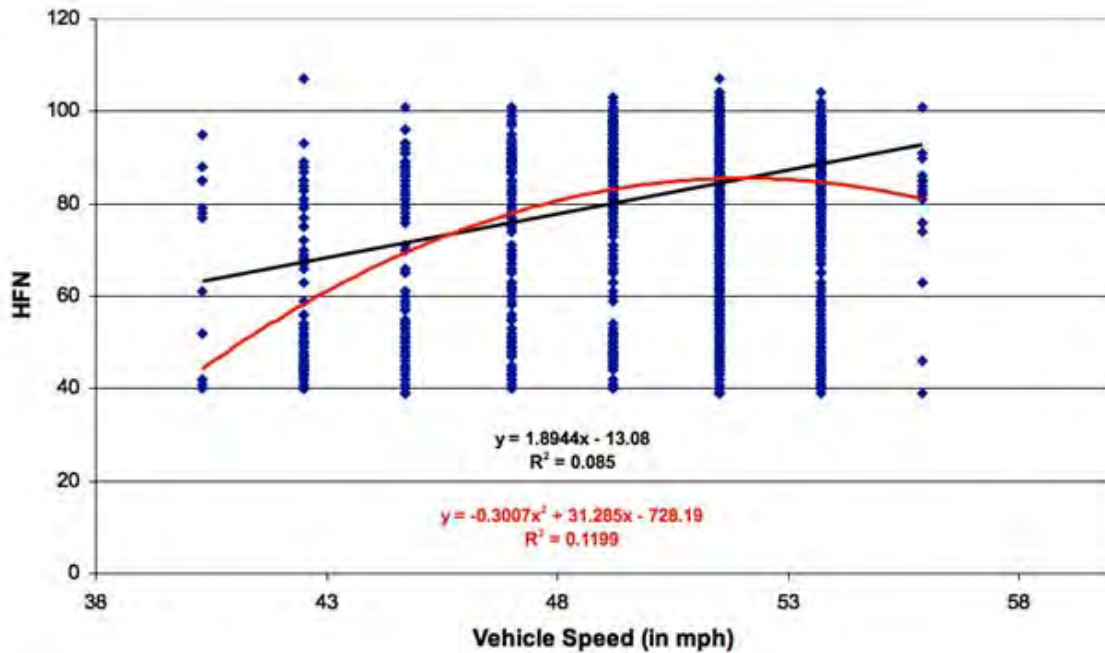

FIGURE 7 Scatter plot for HFN values and vehicle speed for all events during the 2006–2007 winter season, restricted to northbound I-29 segments. Conventions follow those of Figure 5.

In all likelihood, results from the better-maintained I-29 segments are likely more representative of any intrinsic relationship between HFN value and vehicle speed.

Aggregation by Pavement Surface

Thus far we have not considered influences from different pavement surfaces, i.e., concrete versus asphalt versus aggregate, not to mention surfaces of the same type but different age (which can impact the porosity, surface tension and other physical properties of the pavement). Our analysis in this area is continuing and therefore here we present preliminary results, without removal of outliers or other filtering in Figures 8 and 9.

The figures show little difference in the basic direction and slope of the linear regression curves, though the concrete parabolic regression is quite different, representing a very broad, quasi-linear curve over the data range of interest. We speculate that this difference ends up being of relatively minor importance because of the low percentage (~5%) of lane-miles on both US-2 and I-29 segments surfaced with concrete. We anticipate that the breakdown of the asphalt segments by age, color, etc. may provide a more significant result. Those results will be presented at a future date.

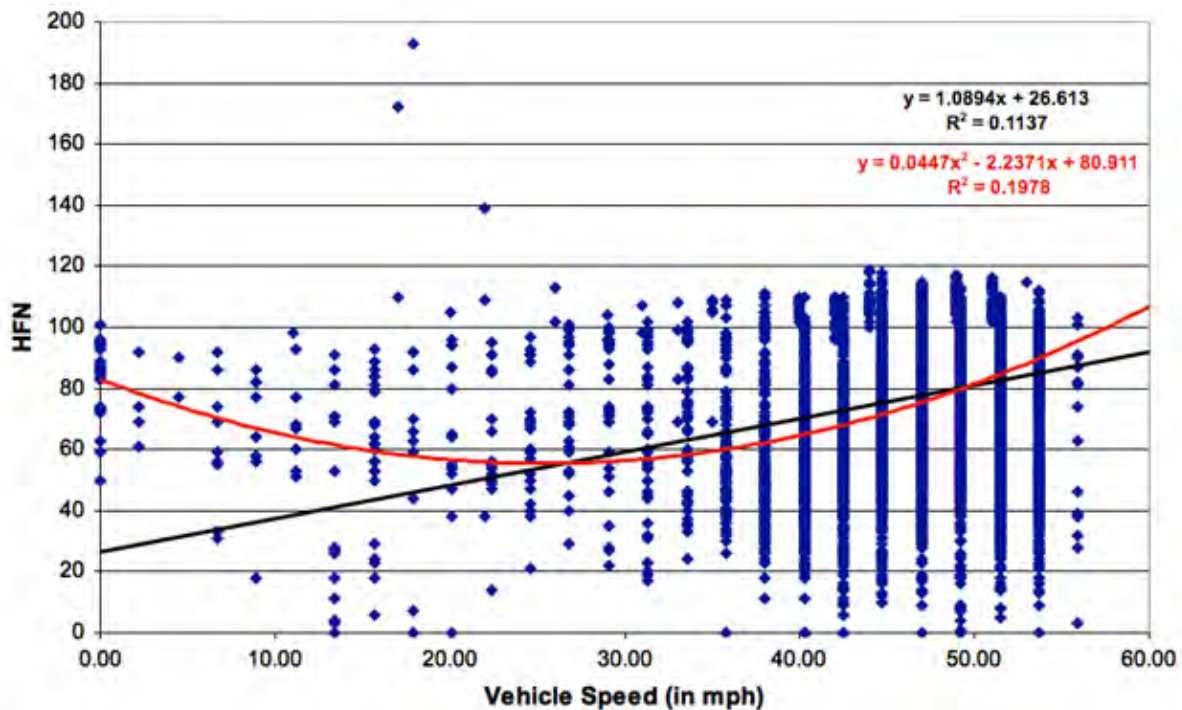

FIGURE 8 Scatter plot for HFN values and vehicle speed for all events during the 2006–2007 winter season, restricted to asphalt pavement segments. Conventions follow those of Figure 5 except no outlier removal or filtering has occurred.

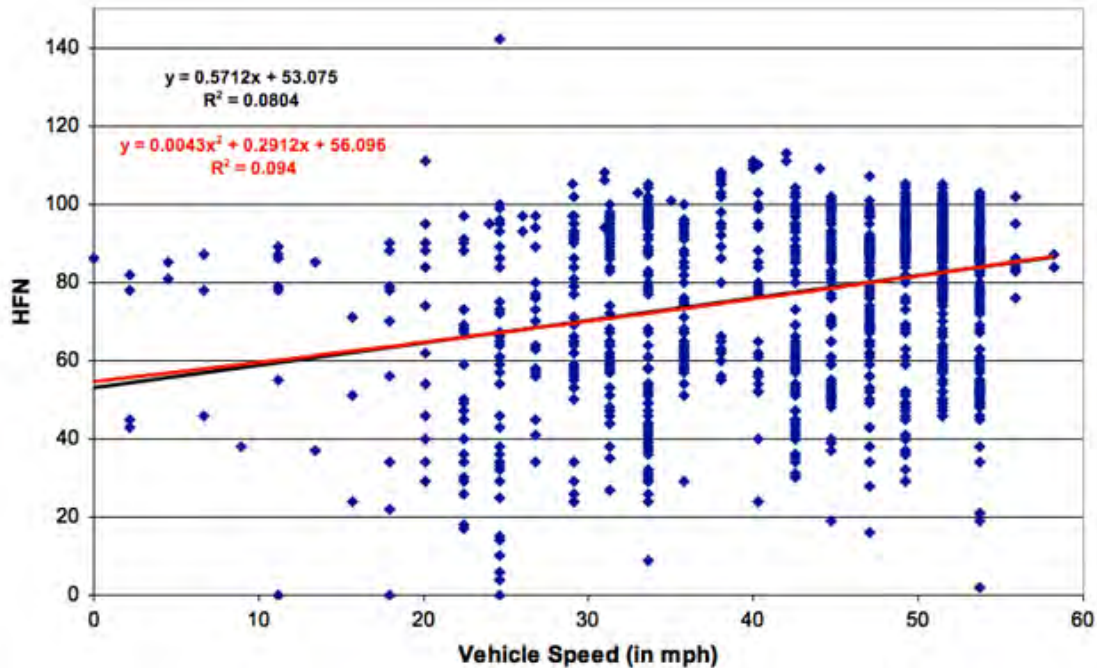

FIGURE 9 Scatter plot for HFN values and vehicle speed for all events during the 2006–2007 winter season, restricted to concrete pavement segments. Conventions follow those of Figure 8.

CONCLUSION

We have omitted the validation of the RT3 observations for brevity. We note that analysis of the merged RT3–RedHen GPS–Video dataset shows, quite convincingly, that the RT3 is capable of distinguishing changes in roadway traction conditions over very fine scale (~ 0 15 m) with good fidelity and repeatability. When averaged out to larger scales (~ 0 200 m and greater), the RT3 provides an excellent indicator of segments where pavement conditions require greater maintenance treatment as opposed to segments which have acceptable traction.

Slight dependence of the road grip (HFN) values on vehicle speed and pavement temperature were noted. The former result is consistent with that from previous ODOT testing. It is also consistent with tests performed during NASA’s Wallops Island Friction Workshop in May 2007, using an untreated ASTM 524 tire and 1-mm water thickness as per runway friction testing requirements (6). The latter result may be largely fortuitous due to the need to reduce speeds for safety considerations. A better determination of the pavement temperature relationship, as well as the relationships to pavement material and age, awaits further analysis.

The RT3 was very reliable even under severe snow and ice conditions, though with heavy snowfall events it was necessary to occasionally clean packed snow and slush away from the auxiliary wheel. Otherwise, the unit operated at temperatures down to nearly -26°C with virtually no maintenance required over the winter season.

ACKNOWLEDGMENTS

This work is supported under Iowa Department of Transportation Contracts PC00404 and PC00399 administered by the State of Iowa on behalf of the Aurora Program, the Rural Geospatial Innovations funded by the U.S. Department of Agriculture under contract #832G720, and by FHWA-sponsored Research Program Funds through the North and South Dakota Departments of Transportation under contract ITS-9999(174).

REFERENCES

1. Goodwin, L. *Weather-Related Crashes on U.S. Highways in 2001*. 2003. www.ops.fhwa.dot.gov/weather/docs/2001CrashAnalysisPaperV2.doc. Accessed November 29, 2007.
2. Lombardo, L. Overview of U.S. Crashes and Environment. Presented at WIST II Forum, Office of the Federal Coordinator for Meteorology, December 4–6, 2000.
3. *Where the Weather Meets the Road: A Research Agenda for Improving Road Weather Services*, National Academy Press, Washington, D.C., 2004.
4. Evans, D. The Ohio Department of Transportation Road Grip Tester Project. In *Transportation Research Circular E-C098: Maintenance Management 2006: Presentations from the 11th AASHTO-TRB Maintenance Management Conference*, Transportation Research Board of the National Academies, Washington, D.C., 2006, pp. 103–113.
5. Clonch, D. Personal communication, May 2006.
6. Halliday, D. Personal communication, May 2007.
7. *2006 North Dakota State Traffic Counts*. <http://www.dot.nd.gov/road-map/traffic/index.htm>. Accessed November 26, 2007.

Blowing and Drifting Snow

BLOWING AND DRIFTING SNOW

The Physical Nature and Prediction of Blowing Snow Within the Roadway Environment

BENJAMIN W. HERSHEY

Meridian Environmental Technology, Inc.

LEON F. OSBORNE, JR.

University of North Dakota

Blowing snow presents one of the greatest challenges for maintenance personnel in snow and wind-blown regions. Blowing snow causes reduced driver visibility and snow-drifted and icy roads. The uncertainty associated with blowing snow events in maintenance decision making represents a major obstacle in effective and efficient responses during and after winter storms. The reduction of uncertainties associated with blowing snow events requires a broad understanding of the physical atmospheric, land surface, and roadway environment aspects leading to blowing snow. To achieve a more reliable prediction model for when and where blowing snow will occur within the roadway environment, a process was established to combine field experimentation with computer simulation to characterize the nature of blowing snow adjacent to an active Interstate highway. This paper presents results of the analysis and prediction of blowing snow mass flux within a roadway environment during the winters of 2005–2006 and 2006–2007. The blowing snow mass flux observations are used to validate a roadway environment blowing snow prediction system along with comparison with data from environmental sensor station data. The influence observed by blowing snow on pavement condition, pavement temperature, and visibility throughout different weather events is presented to relate the importance and challenges associated with blowing snow for maintenance decision makers.

Snow and ice control actions are one of the biggest challenges to winter maintenance personnel. The decision-making process is often complicated by the effects blowing snow has on the roadway, which can include snow build up that can be up to one hundred times the amount of snow that falls during a precipitation event (Tabler, 2003). Not only is blowing snow problematic for maintainers of the road, it can also lead to unsafe conditions for travelers. The occurrence of blowing snow can result in both reduced visibility and snow accumulation on the road (Pomeroy, 1988). Because of the effects blowing snow has on use of roadways, maintenance personnel regard blowing snow as the number one hazardous weather condition that occurs during winter months.

The purpose of the research reported by this report was to investigate the characteristics of blowing snow in a roadway environment, to investigate the relation of blowing snow to atmospheric conditions, and relate the observed conditions to a blowing snow model developed to estimate impacts within roadway environment. The work relied upon research activities conducted by various researchers involved with general transport of snow within a hydrological setting and research conducted to relate blowing snow to a roadway environment. The review of this prior research and field experiments associated with a dedicated roadway field research

facility that included specialized blowing snow measurement systems led to a characterizing of blowing snow properties and comparing observations to model output.

BACKGROUND

Fundamentals of Blowing Snow

Understanding the dynamics of blowing snow is the foundation for analyzing blowing snow in the roadway environment. Maintenance personnel and motorists recognize blowing snow as a major winter hazard in the roadway environment. Tabler (1991b) states that blowing snow is a maintenance engineer's "nightmare" that leads to reduced visibility and vehicle accidents and that blowing snow can make snow removal nearly impossible. Because blowing snow is a major hazard to the traveling public and the overall dynamics of blowing snow is not completely understood, it requires serious attention from both the science and maintenance communities. To properly study blowing snow within the roadway environment observations and experiments need to be conducted in this environment.

Blowing snow can occur from two different sources. The definition of blowing snow provided by Mellor (1965) is

- Any snow that is falling and being advected by the wind or
- Snow that has been previously deposited and is being redistributed by the wind.

Each one of these two scenarios can occur simultaneously under the right conditions. This is an important distinction to make as the concept of blowing snow can be ambiguous and must be properly defined. The users of the roadway environment are greatly affected by both types of blowing snow.

Snow that has fallen and is being redistributed by the wind has some interesting properties that need to be understood to study blowing snow. Bagnold (1941) performed theoretical calculations of mass flux of blowing sand based upon observations. The observations by Bagnold led to the understanding of saltating snow particles within the lowest layers of the atmosphere. As defined by Mellor (1965), blowing snow occurs in three major stages (or layers) known as creep, saltation, and turbulent diffusion (also known as suspension). The creep layer is confined to the layer within 1 mm of the surface where rolling of particles is the dominant motion, the saltation layer is from approximately 0.1 to 100 cm where snow particles are lofted due to momentum transfer, and the turbulent diffusion layer is from approximately 10 to 100 m where the greatest horizontal transport and sublimation occurs. The creep layer was incorporated in the saltation layer for this study for the purpose of mass flux calculations. For this study the saltation layer was considered only to a height of 10 cm, which corresponds to the defined depth of the saltation layer by Pomeroy (1988). Further, Pomeroy's definition of the saltation process was the basis for considering the properties of snow mass transport. Saltating particles are defined as snow particles that have been lofted off of the surface snow pack. Since, due to the force of gravity, they are not carried farther into the atmosphere, they crash back into the snow pack and dislodge more particles, which continuing the cycle of saltating particles (Li and Pomeroy, 1997; Kind, 1981). The cycle of saltating particles is promoted by collisions between saltating particles and the snow pack, which dissipates the kinetic energy of the descending

particles and dislodges particles from the snow pack, thus transferring kinetic energy to newly ejected particles.

There are several atmospheric and snow conditions that lead to the occurrence of blowing snow of an existing snow pack. Of these, wind speed is the most important atmospheric variable that dictates the possibility and extent of blowing snow in any location (Pomeroy, 1988). Air temperature and snow pack characteristics also affect the potential of snow redistribution. As Mellor (1965) states, the wind speed needed to distribute snow from the surface depends upon the conditions of the surface snow. If the snow is fairly loose and unbonded, low wind speeds (3 to 8 m s⁻¹) can redistribute snow, but if the snow pack has matured and settled, it may take winds greater than 30 m s⁻¹ to dislodge particles.

Surface snow bonding is also a variable that is helpful in understanding the ability of individual particles to experience redistribution. Three snow cohesive regimes modulate the initiation of blowing snow (Li and Pomeroy, 1997):

1. A wet regime in which particle movement is reliant on the amount of snowmelt water near 0°C,
2. A warm regime in which a quasi-liquid layer surrounding particles exists, and
3. A cold regime in which a thin quasi-liquid layer is present.

Pomeroy and Li also investigated the relationship between ambient air temperature, wind speed, and blowing snow. Understanding the mass and heat transfer within the snow pack are critical elements in blowing snow occurrence calculations. Unfortunately, the mass and heat transfer is not presently accurately modeled. Because of the inability to properly model these and, thus, snow pack temperatures, Pomeroy and Li used ambient air temperature in their blowing snow model. For dry snow, which is defined as surface snow that has not experienced temperatures above 0°C or experienced any liquid precipitation, they developed a threshold wind speed for the occurrence of blowing snow using temperature:

$$U_i(10) = a + bT + cT^2 \quad (1)$$

where $U_i(10)$ is the wind speed at 10 m (m s⁻¹), T is the ambient air temperature at 2 m (°C), and the empirical parameters are $a = 9.34$ m s⁻¹, $b = 0.18$ °C⁻¹ s⁻¹, and $c = 0.0033$ m °C⁻² s⁻¹.

Pomeroy and Li also provided the following 95% confidence intervals for the empirical parameters:

- 9.27–9.60 for a ,
- 0.16–0.21 for b , and
- 0.003–0.004 for c ,

which result in a standard error of ~1.97 m s⁻¹ in Equation 4. To use Equation 1, surface snow must be present. The relationship in Equation 1 provides another way to determine a threshold for blowing snow occurrence. This can be used to determine if blowing snow is possible within the roadway environment.

Blowing Snow Mass Flux

Blowing snow mass flux is defined as the mass of the particles that pass through an area for a duration of time (e.g., $\text{kg m}^{-2} \text{s}^{-1}$). Pomeroy (1988) studied the mass flux of blowing snow within the suspension layer. Because the mass flux of blowing snow changes with height, mass flux must be measured over several heights to determine a vertical gradient of mass flux. Pomeroy defines the mass flux of blowing snow in the suspension layer at any one height as the combination of drift density (particle density) and the mean particle speed. It is assumed that the mean particle speed is equal to the wind speed at the height of measurement. Using the particle density and mean particle speed results in

$$q_z = \eta_z (u_* / k) \ln(z / z_o) \quad (2)$$

where q_z is the horizontal mass flux of blowing snow at height z and η_z is the particle density (suspended) at height z , k is the von Karman constant, u_* is the friction velocity, and z_o is the roughness length. The total amount of mass flux through the whole layer is given by (Pomeroy 1988)

$$Q_{\text{susp}} = \frac{u_*}{k} \int \eta_z \ln(z / z_o) dz \quad (3)$$

where Q_{susp} is the total mass flux within a defined volume within the suspension layer.

Tabler (1991a) found that the validity of Equation 3 cannot yet be tested but that it is quite likely that mass flux is overestimated in the first three centimeters to the surface. Using Equation 3, Mellor and Fellers (1986) developed an empirical relationship for snow mass flux,

$$\begin{aligned} \ln q = & 10.089 - 0.41049X_1 - 122.03X_2 - 0.13856X_1^2 - 14.446X_1X_2 \\ & - 0.0059773X_1^3 + 3.2682X_1^2X_2 + 114.12X_1X_2^2 + 2290.0X_2^3 \end{aligned} \quad (4)$$

where $X_1 = \ln z$ and $X_2 = 1/u_{10}$, which is a regression equation that relates mass flux q ($\text{g m}^{-2} \text{s}^{-1}$) to height z (m) and wind speed u_{10} (m s^{-1}). Equation 4 is useful for engineering applications but has a major flaw in that it overpredicts the mass flux in the lowest three centimeters closest to the surface (Tabler, 1991a). This overprediction can be as great as an order of magnitude—resulting in inaccurate calculations (Mellor and Fellers, 1986).

Roadway Environment Blowing Snow Model Framework

Estimates of future blowing snow conditions can aid in the safety and mobility of drivers who must travel during winter conditions. The estimates of blowing snow conditions require the combination of snow pack assessment, predicted atmospheric conditions, and an expression of the snow transport mechanisms. The roadway environment blowing snow (REBS) model developed by the University of North Dakota (UND) combines these traits and has been in operational validation since 2005. The REBS model estimates the temporal and spatial evolution of a column of sublimating snow as it is advected through a roadway environment for discrete sections of highways. The lateral extent of the roadway environment varies with terrain, but is

generally considered to be the 1,000 m normal to the upwind side of the road. The snow transport mechanisms of the REBS model are based primarily upon the prairie blowing snow model (PBSM) (Pomeroy and Li, 2000). The model generates hourly values at 10-km intervals of the total particle number concentration of blowing snow particles, a snow particle size distribution, and an estimate of snow mass flux vertical profiles through the sublimation layer along a road network.

Snow pack data assimilation is provided by hourly estimates of snow depth and snow water equivalent on a national 1-km resolution grid made available to UND by the National Oceanic and Atmospheric Administration's National Operational Hydrologic Remote Sensing Center (NOHRSC). The availability of the snow pack in the NOHRSC provided grids to be considered for snow transport is parameterized by considering a land-cover factor based upon land use-land cover characterization derived from the National Land Cover Database (Homer et al., 2004).

Atmospheric inputs to the model include predicted 2-m air temperature, 2-m relative humidity, and 10-m wind speed and direction. The weather research and forecasting (WRF) model (Skamarock et al., 2005) provides hourly model projections of required input atmospheric fields at a 10-km resolution extending to 36 h. To account for local terrain influences, the 10-km WRF output is extracted and downscaled onto a 1-km subdomain for a region bounding the road network containing the individual road segments supported by the modeling system. A decision tree is used to determine whether a threshold for blowing snow has been exceeded and which then triggers the blowing snow prediction portion of the modeling system. The threshold for determining blowing snow utilizes the criteria of a snow-covered surface with an ambient air temperature of less than 8°C (Dery and Yau, 1999) and exceeding a critical threshold 10-m wind speed. The determination of the critical 10-m wind speed follows that proposed by Li and Pomeroy (1997).

METHODOLOGY

Road Weather Field Research Facility

Blowing snow research has been conducted in varying locations throughout the world that include the Canadian prairies, Antarctic, Wyoming, the mountains of Alaska, and areas within Japan. Although there has been blowing snow research conducted within the roadway environment, a dedicated road weather field research facility has never been formally developed. With support from the North Dakota Department of Transportation and the Federal Highway Administration, the UND Surface Transportation Weather Research Center developed the Road Weather Field Research Facility (RWFRF). The RWFRF is located at a former rest area approximately 21 mi south of UND. Its location adjacent to Interstate 29 provides a controlled environment within the roadway to conduct field tests. Observational data collected and analyzed within this study were gathered at the RWFRF.

To investigate the individual blowing snow particles, two dimensional (2-D) video disdrometers were deployed parallel with the RWFRF test roadway. The video disdrometers collect 56 to 59 images per second that allow for fine-resolution particle sampling during blowing snow events. The three disdrometers deployed at the RWFRF are installed at levels of 0.4, 1.2, and 2.7 m. The 0.4-m disdrometer allows for observations within the lowest levels of

the suspension layer. The disdrometer at 1.2 m is deployed at the height that roadway visibility is typically calculated and corresponds to the average noncommercial vehicle height (Matsuzawa and Takeuchi, 2002). The top disdrometer is placed at approximately 2.7 m, which is near the height of commercial vehicle drivers.

The design of the disdrometers was to be nonevasive to the sampling environment if the wind direction exceeded 45° from the line of alignment of the disdrometers (Newman 2007). The disdrometers were placed facing at approximately 15° to the right of true north. This means that turbulence from the disdrometers setup can affect calculations if wind direction is between 330° – 60° and 150° – 240° . Figure 1 illustrates wind directions that cause turbulence that would in turn affect the data collection and quality. Data collected within these wind direction thresholds are not used.

Complementing the data from the video disdrometers are data from air temperature sensors, wind speed and direction sensors, moisture sensors, and video cameras. These data sets are used to gain a better understanding of the occurrence of blowing snow within the roadway environment and the atmospheric conditions at the time of blowing snow. As noted by numerous researchers such as Mellor (1965), Schmidt (1981), Tabler (1994), and Pomeroy and Li (2000), wind speed is a crucial variable when calculating blowing snow variables, including mass flux. Temperature is another variable that can be used to determine if blowing snow is possible. The wind direction was used to determine if the data collected from the disdrometers had a possibility of being affected by turbulence resulting from the instruments infrastructure. Finally, camera images provide an important validation data set for the occurrence of blowing snow.

Figure 2 shows the instruments located at the RWFRF used in this study. Wind sensors were at the same heights as the disdrometers along with a wind sensor mounted at 5 m. The data collected from these instruments aided in the calculation of mass flux and validating data collected from the disdrometers. Data collected with the disdrometers were reduced in a data processing chain and validated prior to their use in the study. The calculation of blowing snow mass flux involved the determination of the total particle mass found within the depth of view of the disdrometer cameras. All particles viewed were assumed to be spherical in shape (Schmidt

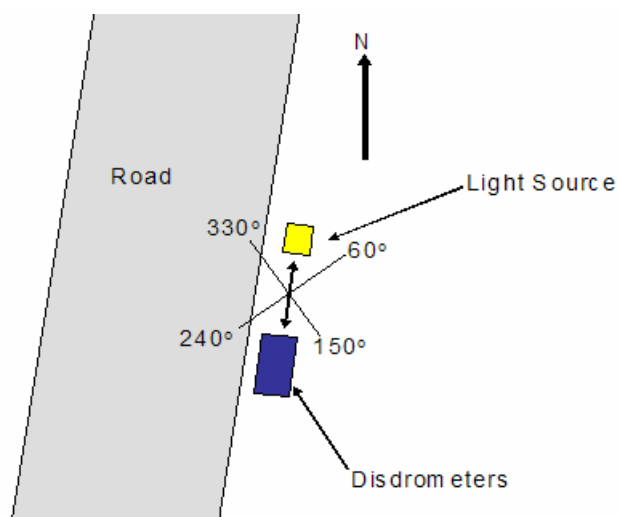

FIGURE 1 The disdrometer setup relative to the road and to the compass heading north. Wind directions between 330° – 60° and 150° – 240° could present turbulence problems.

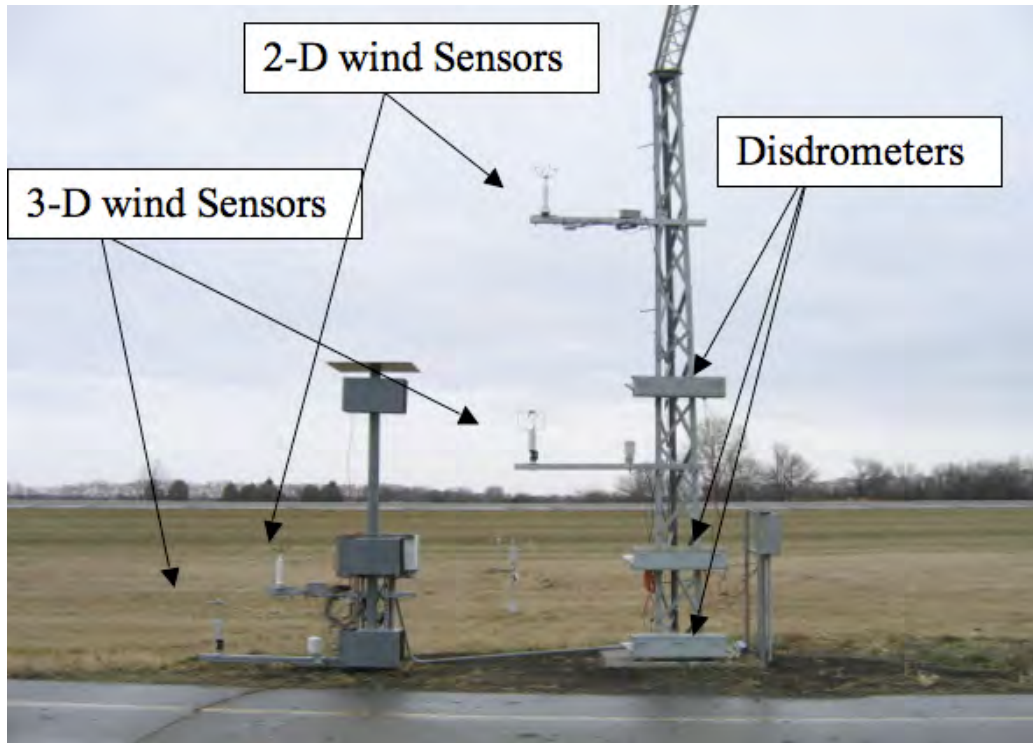

FIGURE 2 Photograph of the array of instruments located directly adjacent to the RWFRF access road. This image shows the two 3-D wind sensors and two 2-D wind sensors. Temperature and relative humidity sensors are also located at the height of each 3-D wind sensor. The sensors located in the background are one of the two precipitation sensors located at the site with an ultrasonic snow depth sensor.

1977 and Tabler, 1979) and to have a density near that of ice (900 kg m^{-3}) (Pomeroy and Li, 2000). The effective depth of the field of view is 100 times the diameter of the individual particles seen in the image (Newman, 2007). This meant that the depth of view changed with different sized particles. The particles were placed in size bins having a 0.05-mm width, with the numbers in each bin resulting from sums over one second of data. The total numbers of particles detected in each second are then normalized to the largest depth of field observed. Blowing snow particles are assumed to be smaller than 0.5 mm as this is the largest size possible for redistributed blowing snow particles (Tabler, 2003). Thus, the number of particles in the 0.125-mm bin size was normalized to the depth of field for particles of 0.5 mm in diameter. This procedure of normalizing the particle numbers per bin size was completed for each bin size at each second. The total volumes of the particle at each second were calculated and a mass was determined. The values of u_* and k are defined as 0.35 m s^{-1} and 0.4. These values were defined by Pomeroy and Li (2000) within the PBSM. The value of u_* changes with changing wind speed so by making it a fixed value it provides the amount of mass of snow within the air not necessarily blowing snow mass flux. If u_* is allowed to vary with wind speed the result would be blowing snow mass flux.

ANALYSIS

A representative case study occurred over a 3-day period in the middle of December 2005. A strong low pressure system moved across the Northern Plains of the United States depositing several inches of snow across the eastern half of North Dakota. As the low-pressure system tracked off to the east, strong north–northwest winds developed causing blowing snow conditions in the Red River Valley of the North. The first field analyzed for this case and all case studies is the wind direction. Figure 3 shows the wind direction from 1600 UTC to 1700 UTC on December 15, 2005. The observations are from an anemometer at a 10-m height located approximately 100 m from the disdrometers' location.

The variability in wind direction between 1600 UTC and 1700 UTC on December 15, 2005, ranged from 315° to 347°. One of the assumptions used in the analyses was that for wind directions between 330° and 60° turbulence could be affecting the particles being captured by the disdrometers. The first 2,220 s of this hour (37 min) have average wind directions consistently greater than 330° at a height of 10 m. Using the threshold provided above, the first 37 min of the 1600 UTC hour has an influence of turbulence due the housing structures of the disdrometers that makes the data collected inaccurate. There was one time period in the first 37 min when the wind direction was less than 330°. This time period was from 960 s to 1260 s (16 to 21 min). The average wind direction during this 300-s time period is 330.1°.

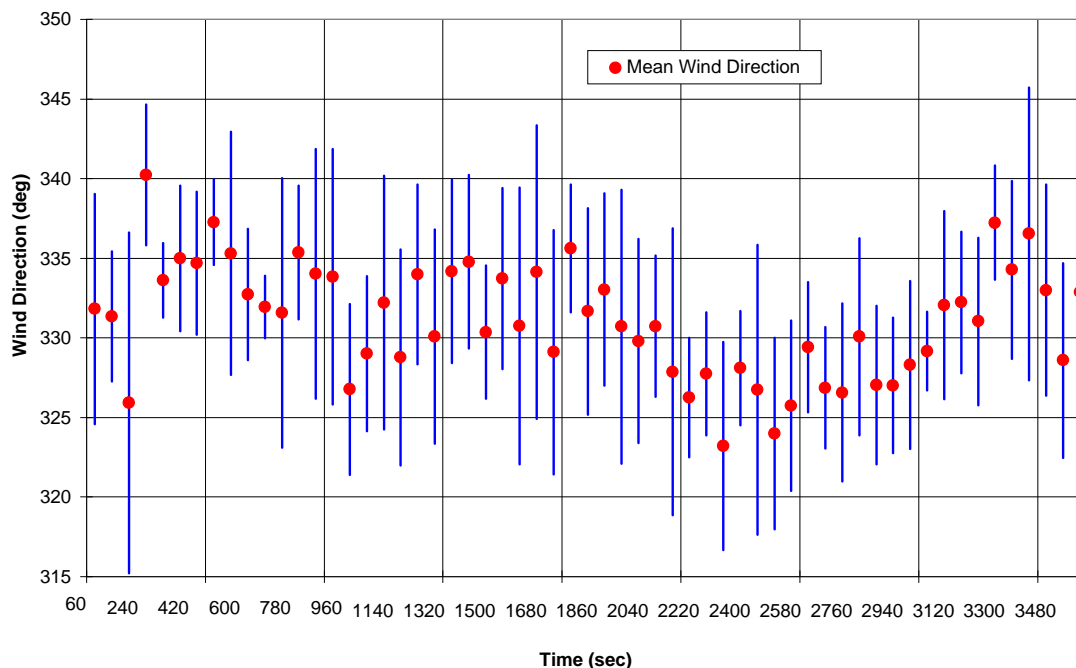

FIGURE 3 This graph shows wind direction at 10 m on December 15, 2005, at 1600 UTC. The red dots are 1-min averages of wind direction. The blue line at each observation time is the standard deviation from the average wind direction.

Figure 4 shows the wind speed for the period of one hour beginning at 1600 UTC December 15, 2005. Similar to the wind direction, there is some variability in the wind speed. Even though there is variability in wind speed, values are generally between 7 and 10 m s⁻¹. Using the relationship developed by Li and Pomeroy (1997) given in Equation 1 it is possible to estimate the threshold wind speed for blowing snow at a given air temperature. From 1600 to 1700 UTC the air temperature fluctuated between -9.7°C and -9.5°C. The average threshold wind speed over the entire 1600 UTC hour is 7.99 m s⁻¹. Almost the entire 16 UTC data indicated average wind speeds that met or exceeded a 7.9-m s⁻¹ threshold. Thus, from the Li and Pomeroy relationship there was a possibility of blowing snow throughout the entire 1600 UTC hour. All observations during the 960- to 1260-s period exceed the 7.99 m s⁻¹ threshold indicating that the Li and Pomeroy relationship is valid for this time period.

Wind speed and direction relationships indicated that blowing snow could be expected to be observed in this case. Once wind speed and direction criteria were determined to be met, the mass flux was computed using the disdrometers. Calculated mass flux and empirical blowing snow mass flux relationships were compared to see how well they matched. Figure 5 shows a comparison between the calculated values of mass flux from the 0.4-m-height disdrometer and those corresponding to Mellor and Fellers' empirical relationship. Throughout the 1-h period the calculated mass flux was approximately 2.3 g m⁻² s⁻¹ less than the empirical relationship of Mellor and Fellers.

Figure 6 shows the UND REBS model output for the period from 12 UTC to 20 UTC December 15, 2005. The model estimated snow mass flux at 16 UTC was 1.1 g m⁻² s⁻¹, which corresponds closely to the disdrometer measurements. Model estimates of 0.55 g m⁻² s⁻¹ at 17 UTC correspond more closely to the Mellor and Fellers relationship, as both are dependent upon wind speed values to estimate blowing snow potential.

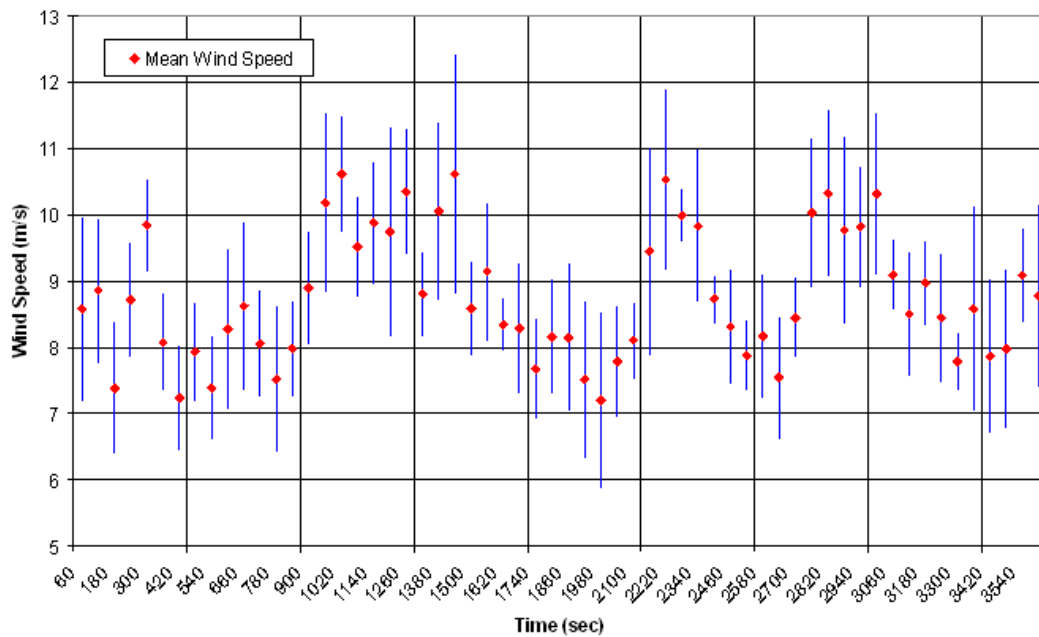

FIGURE 4 The wind speed at 10 m on December 15, 2005, at 1600 UTC. The red dots are 1-min wind speed averages from the 10-m anemometer. The blue lines at each observation are the standard deviation lines for the 1-min averages.

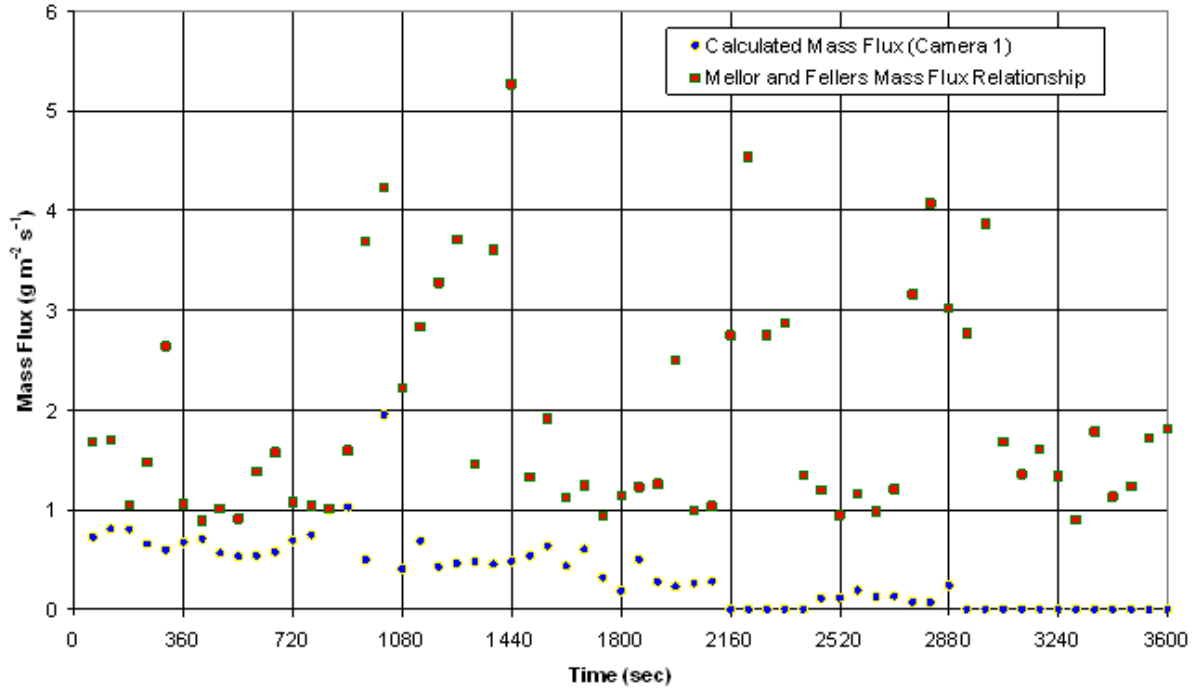

FIGURE 5 The correspondence between calculated mass flux (blue diamonds) from the disdrometers and Mellor and Fellers’ relation (boxes). The values are averages over a minute to reduce the amount of noise within the data.

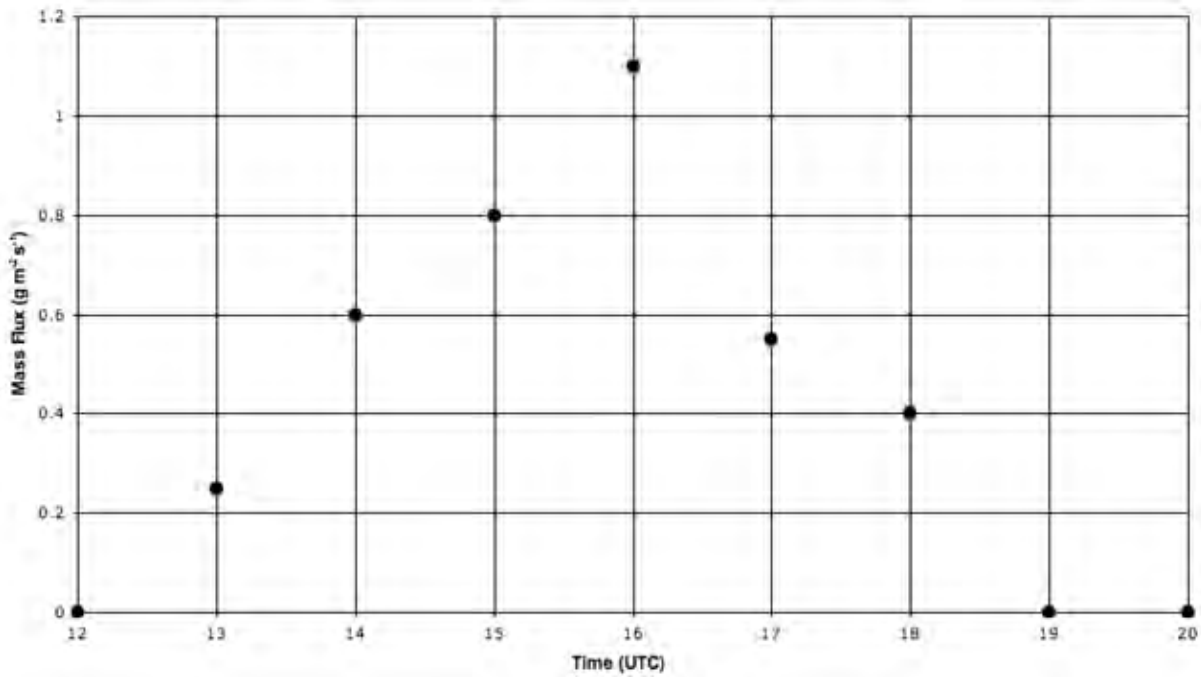

FIGURE 6 Estimates of blowing snow mass flux during the period 12 UTC to 20 UTC December 15, 2005. Estimates are from the UND Roadway Environment Blowing Snow model.

SUMMARY

Snow is a major travel problem in winter regions and the problem can be compounded if blowing snow impacts the roadway environment. A literature review was conducted in this study to gain an understanding of previous research conducted on blowing snow and blowing snow mass flux. Blowing snow research has been conducted in many different locations including mountainous terrain, open prairies, polar regions, and to a limited extent within the roadway. From this research it is clear that many variables impact the occurrence of blowing snow. For existing snow pack, the most important variable is wind speed and the occurrence of blowing snow can be estimated based upon exceeding a wind speed threshold that is a function of temperature. The detection of blowing snow mass flux is a challenging endeavor but one of importance to validate empirical relationships and blowing snow prediction models. Such a blowing snow model that was developed by UND was found to provide reasonable predictions when compared against the observed values derived from a video disdrometer.

ACKNOWLEDGMENTS

This work is supported under Federal Highway Administration Sponsored Research Program Funds through the North Dakota Department of Transportation.

REFERENCES

- Bagnold, R. A. *The Physics of Blown Sand and Desert Dunes*. Chapman and Hall, London, 1941.
- Déry, S. J., and M. K. Yau. A Bulk Blowing Snow Model. *Boundary-Layer Meteorol*, Vol. 93, 1999, pp. 237–251.
- Homer, C., C. Huang, L. Yang, B. Wylie, and M. Coan. Development of a 2001 National Land-Cover Database for the United States. *Photogrammetric Engineering and Remote Sensing*, Vol. 102, No. 7, 2004, pp. 829–840.
- Kind, R. J. Drifting Snow. In *Handbook of Snow: Principles, Processes, Management, and Use* (D. M. Gray and D. H. Male, eds.), Pergamon Press, 1981, pp. 338–359.
- Li, L., and J. W. Pomeroy. Probability of Blowing Snow Occurrence by Wind. *Journal of Geophysical Research*, Vol. 102 (D18), No. 21, 1997, pp. 955–964.
- Matsuzawa, M., and M. Takeuchi. Study on Methods to Calculate Visibility on Blowing Snow. *SIRWEC 11th International Road Weather Conference*, Sapporo, Japan, 2002. Available at www.iac.ethz.ch/staff/wueest/sirwec/conferences/sapporo2002/matsuzawa.pdf.
- Mellor, M. Blowing Snow. *US CRREL Monogr.* Pt. 3, Sec. A3c, Hanover, N.H., 1965.
- Mellor, M., and G. Fellers. Concentration and Flux of Wind-Blown Snow. Special Report 86-11. U.S. Army Corps of Engineers, Cold Regions Research and Engineering Laboratory, 1986, p. 16.
- Newman, A. Surface and Vertical Retrievals of Snowfall Using a Video Disdrometer and A 915 MHZ Vertical Profiler. MS thesis. University of North Dakota, 2007.
- Pomeroy, J. W. Wind Transport of Snow. PhD dissertation. University of Saskatchewan, 1988.
- Pomeroy, J. W., and L. Li. Prairie and Arctic Areal Snow Cover Mass Balance Using a Blowing Snow Model. *Journal of Geophysical Research*, Vol. 105 (D21), 2000, pp. 26619–26634.
- Schmidt, R. A. A System That Measures Blowing Snow. USDA Forest Service Research Paper RM-194, 1977.
- Schmidt, R. A. Estimates of Threshold Windspeed from Particle Sizes in Blowing Snow. *Cold Regions Science and Technology*, Vol. 4, 1981, pp. 187–197.

- Skamarock, W. C., J. B. Klemp, J. Dudhia, D. O. Gill, D. M. Barker, W. Wang, and J. G. Powers. A Description of the Advanced Research WRF, Version 2. *NCAR Technical Note, NCAR/TN-468+STR*, NCAR/MMM, Boulder, Colo., 2005. Available from the National Center for Atmospheric Research.
- Tabler, R. D. Visibility in Blowing Snow and Applications in Traffic Operations. In *Special Report 185: Snow Removal and Ice Control Research*, TRB, National Research Council, Washington, D.C., 1979.
- Tabler, R. D. Snow Transport as a Function of Wind Speed and Height. In *Cold Regions Engineering. Proceedings, Cold Regions Sixth International Specialty Conference TCCP/ASCE*, West Lebanon, N.H., 1991a, pp. 729–738.
- Tabler, R. D. *Snow Fence Guide*. Report SHRP-H-320. SHRP, National Research Council, Washington, D.C., 1991b.
- Tabler, R. D. *Design Guidelines for the Control of Blowing and Drifting Snow*. Report SHRP-H-381. SHRP, National Research Council, Washington, D.C., 1994.
- Tabler, R. D. *Effect of Blowing Snow and Snow Fences on Pavement Temperature and Ice Formation*, 2003.

BLOWING AND DRIFTING SNOW

Geospatial Variability of Roadway Vegetation and Blowing Snow**SCOTT S. KROEBER****DAMON M. GRABOW****LEON F. OSBORNE, JR.***University of North Dakota*

Winter travel in the Snow Belt areas of the United States can be hazardous during times of blizzards, winter storms, and blowing snow events. For surface transportation, precipitation does not have to be falling in order for travel to become hazardous. Wind alone can transport snow onto the roadway, which reduces visibility, and can begin to accumulate. The areas of roadway accumulation depend on the orientation of the roadway with respect to the prevailing winds during the event, the amount of snow mass present, and surface roughness factors along the roadway. Identifying the surface roughness or vertical extent of the vegetation is a geospatial problem that can be accomplished with ground-based observations. The University of North Dakota has been a national leader in the innovation of traveler information decision support systems and its location within the upper Midwest offers an excellent opportunity to assist rural America with improving methods of increased traveler safety through the study of blowing snow. Blowing snow models are currently being developed that would benefit greatly if detailed information on surface roughness and obstructions could be incorporated into the model initialization. This study was done using video embedded with Global Positioning System data to build a roadway vegetation data set in a geographic information system. The vegetation data were then used to initialize the computer model. This same video system was then used to map the locations of blowing snow so that it could validate the computer-based blowing snow model. The mapped locations for blowing snow were analyzed and compared to model outputs. This presentation will show the results from the development of a blowing snow susceptibility index. It will highlight the need for a blowing snow susceptibility index as well as examples of vegetation categories within our region used for surface transportation weather research.

The location of blowing snow was geospatially documented during the winters of 2005–2006 and 2006–2007 along two test sections of independent roadways. This documentation was done to investigate the relationship between the location of blowing snow on the roadway and the location of vegetation next to the roadway. The premise of this investigation is that it is possible to establish a blowing snow susceptibility index to categorize the intensity and geographical variances of blowing snow as they pertain to land use and land-surface influences. The intent of this investigation is to analyze the roadway vegetation management plan and its effect on blowing snow and improve upon the forecasting of blowing snow. As the data collection process is not yet completed the results and statistics generated by this study are based on a small sample set. This Blowing Snow Susceptibility Index (BSSI) is being developed for potential inclusion within the pooled-fund study maintenance decision support system. This index will indicate to the user the locations of preferred blowing snow and potential factors relating to intensities of blowing snow. The present work is part of collaborative research with the Rural Geospatial InnovationS (RGIS) Great Plains, a University of North Dakota (UND) research effort funded by the U.S. Department of Agriculture.

METHODOLOGY

The areas of roadway snow accumulation due to blowing/drifting snow depend on the orientation of the roadway with respect to the prevailing winds (speed and direction) during the event, the amount of snow mass present, and surface roughness factors along the roadway. Some of these variables are employed or created directly within a blowing snow model while others are not yet incorporated. Of particular concern of this work is the identification of the surface roughness or vertical extent of the vegetation. This is a geospatial problem being addressed with ground-based observations.

Two sections of roadway were utilized for vegetation mapping for the BSSI studies (Figure 1). Both roadways are similar in terrain and vegetative features; however, they differ in their direction with one oriented in the east–west direction and the other in the north–south direction. Both roadways are in the same general location and experience similar weather conditions. Having roadways with a 90-degree offset allows for the comparison of effects that different wind directions have on the road with each individual weather event.

Vegetation type was placed into one of two categories, major vegetation and minor vegetation (Figure 2). Examples of major vegetation would be tall brush, trees, shelterbelts, or



FIGURE 1 Locations of the two test sections in eastern North Dakota used for vegetation mapping and blowing snow relationship.

manufactured structures, whose distance to the roadway is less than 10 times the height of that feature. A template was created to identify each of the categories during the data processing using a 1 to 10 rule for obstructions (Ahrens, 2000), meaning one unit in the vertical has an influence that is 10 units in the horizontal. Examples of minor vegetation are cattails, and tall grass growing in the roadway ditch that reaches a substantial height. The two types of vegetation along the test sections were mapped using a side-pointing video camera coupled with Global Positioning System (GPS) and digital processing software.

Software used was the GeoVideo software from Red Hen Systems, Inc., that produces georeferenced video data (Figure 3). The Red Hen System software application runs under the Environmental Systems Research Institute (ESRI) geographic information systems (GIS) platform; in this case ESRI's ArcGIS, and allows for the creation of a georeferenced file of location events (Figure 4). The GeoVideo and GPS data were then used for the conversion of the georeferenced video data to a geospatial grid. The vegetation was mapped for each side of the roadway so that depending on the direction of the prevailing wind for a specific blowing snow event the vegetation from the upwind side of the road could be used.

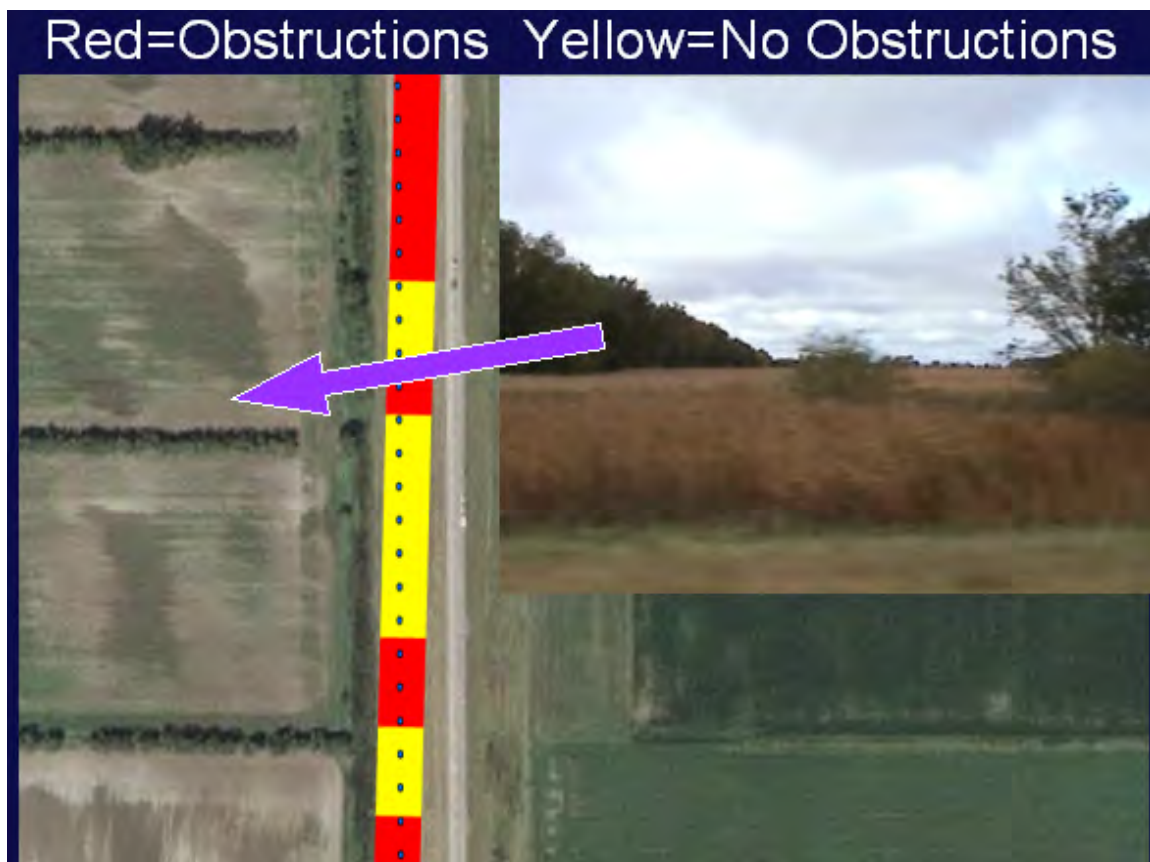

FIGURE 2 Vegetation grid superimposed onto aerial photo with inset photo taken from ground view.



FIGURE 3 Red Hen Systems, Inc., VMS 300 GPS unit used to collect GPS data.



FIGURE 4 Sony DCR-DVD301 used to record GPS data and voice notes.

ROADWAY BLOWING SNOW DOCUMENTATION

While it may seem intuitive that vegetation does have an influence on blowing snow, the effects of the vegetation may change with respect to the temporal occurrence of a snow event within the winter season. During the early portions of the winter season vegetation along the roadway will have a higher holding capacity for snow, whereas at the latter portions of the season the holding capacity will be diminished due to the accumulated snow within the vegetation and the roadway right of way. While no conclusions can be made at this time the premise is that an adequate sample of blowing snow events will yield a positive correlation.

The roadway blowing snow documentation is being conducted in a similar fashion as the roadway vegetation mapping. The blowing snow validation also uses the Red Hen System video system and mapping technique. However, the major difference is that a forward facing camera angle was utilized. ESRI's ArcGIS along with the Red Hen System application was used to convert the video data into a georeferenced grid. The final product is a grid along the roadway representing two categories, those areas with blowing snow and those with no blowing snow. The grid pixels are 30 m by 30 m and will be compared to the 1-km data from the blowing snow model. The validation data collection process was used during forecasted blowing snow events throughout the 2005–2006 and 2006–2007 winter seasons with the data post processing performed post-season. [Table 1](#) lists the events for the 2005–2006 winter season and [Table 2](#) lists the events for the 2006–2007 winter season. There were 16 days with weather events and there were 42 data collection activities for blowing snow locations. A data collection activity (road patrol) consists of a recording of one direction along one of the test segments. There was one instance on December 15, 2005, where two road patrols were recorded onto one DVD.

Results of the BSSI vegetation and documentation activities are expected to be available prior to the beginning of the winter 2006-07 field season activities. Based upon the analysis results a refinement of the data collection and analysis process will be made.

By developing a partnership with RGIS–Great Plains, whose goal is technology transfer and rural geospatial research, the Surface Transportation Weather Research Center was able to research the effect of roadside vegetation on blowing snow. The study area for this project consisted of four routes; Interstate 29 northbound–southbound corridor and the U.S. Highway 2 eastbound–westbound corridor.

All the blowing snow events were divided into categories depending on the prevailing winds. Those events that had a predominantly northerly wind were used for the eastbound–westbound corridor and those events that had a predominantly westerly wind were used for the northbound–southbound corridor. The location along the roadway where blowing snow occurred (Yes Snow) and those locations along the roadway where no blowing snow occurred (No Snow) were then converted into a grid with all grids being aggregated for a total pixel count. The following table shows the results from each corridor. The vegetation code in the left column indicates what vegetation was present next to the roadway. This vegetation height allowed for the 1 to 10 rule to be used for obstructions, meaning one unit in the vertical height of the vegetation has an influence that is 10 units in the horizontal direction. For example “veg1cat0” indicates that there was major vegetation “veg1” such as trees, but no minor vegetation “cat0” such as cattails or grass. The US-2 segment did not have any minor vegetation since it had been mowed so an urban classification “urb” was created in order to try and identify these effects

TABLE 1 Summary of Research Events Conducted for Blowing Snow Susceptibility Index Development During Winter 2005–2006

Date	Year	Month	Day	Time	Highway	Direction
20051117	2005	November	17	3:26 p.m.	Hwy 2	East
20051117	2005	November	17	3:09 p.m.	Hwy 2	West
20051128	2005	November	28	3:55 p.m.	I-29	South
20051128	2005	November	28	5:03 p.m.	I-29	North
20051215	2005	December	15	1:44 p.m.	Hwy 2	East
20051215	2005	December	15	1:14 p.m.	Hwy 2	West
20051215	2005	December	15	2:27 p.m.	I-29	South/north
20060108	2006	January	8	12:09 p.m.	I-29	South
20060108	2006	January	8	12:29 p.m.	I-29	North
20060116	2006	January	16	11:51 a.m.	I-29	South
20060116	2006	January	16	12:16 p.m.	I-29	North
20060116	2006	January	16	12:46 p.m.	Hwy 2	West
20060116	2006	January	16	1:15 p.m.	Hwy 2	East
20060116	2006	January	16	5:06 p.m.	I-29	South
20060116	2006	January	16	6:00 p.m.	I-29	North
20060124	2006	January	24	11:32 a.m.	Hwy 2	West
20060124	2006	January	24	10:56 a.m.	I-29	North
20060124	2006	January	24	2:12 p.m.	I-29	South
20060131	2006	January	31	5:45 p.m.	Hwy 2	West
20060207	2006	February	7	9:17 a.m.	I-29	South
20060207	2006	February	7	9:38 a.m.	I-29	North
20060209	2006	February	9	8:10 a.m.	Hwy 2	West
20060209	2006	February	9	8:39 a.m.	Hwy 2	East
20060210	2006	February	10	9:16 a.m.	Hwy 2	West
20060214	2006	February	14	10:58 a.m.	Hwy 2	East
20060214	2006	February	14	10:25 a.m.	Hwy 2	West
20060214	2006	February	14	2:17 p.m.	I-29	South
20060214	2006	February	14	2:53 p.m.	I-29	North
20060216	2006	February	16	6:07 p.m.	Hwy 2	West
20060221	2006	February	21	11:20 a.m.	Hwy 2	West
20060221	2006	February	21	11:46 a.m.	Hwy 2	East
20060222	2006	February	22	3:37 p.m.	Hwy 2	West
20060224	2006	February	24	9:32 a.m.	I-29	South
20060224	2006	February	24	10:24 a.m.	I-29	North
20060224	2006	February	24	2:12 a.m.	I-29	South
20060224	2006	February	24	10:56 a.m.	I-29	North
20060224	2006	February	24	3:10 p.m.	I-29	North
20060224	2006	February	24	3:10 p.m.	I-29	North
20060224	2006	February	24	3:26 p.m.	I-29	South
20060224	2006	February	24	4:27 p.m.	I-29	North
20060307	2006	March	7	9:16 a.m.	Hwy 2	West
20060307	2006	March	7	9:38am	Hwy 2	East

NOTE: Very few events were optimum for inclusion into the blowing snow events.

TABLE 2 Summary of Research Events Conducted for Blowing Snow Susceptibility Index Development During Winter 2006–2007

Date	Year	Month	Day	Highway	Direction
20060928	2006	September	28		
20061229	2006	December	29	Hwy 2	West
20061229	2006	December	29	Hwy 2	East
20061229	2006	December	29	I-29	South
20061229	2006	December	29	I-29	North
20061231	2006	December	31	Hwy 2	West
20061231	2006	December	31	Hwy 2	East
20061231	2006	December	31	I-29	South
20061231	2006	December	31	I-29	North
20070127	2007	January	27	Hwy 2	West/east
20070127	2007	January	27	Hwy 2/I-29	East/south
20070127	2007	January	27	I-29/Hwy 81	South/north
20070129	2007	January	29	Hwy 2	East
20070129	2007	January	29	Hwy 2	West
20070129	2007	January	29	I-29	All
20070131	2007	January	31	Hwy 2	West
20070131	2007	January	31	Hwy 2	East
20070201	2007	February	1	Hwy 2	West
20070201	2007	February	1	Hwy 2	East
20070224	2007	February	24	Hwy 2	West
20070224	2007	February	24	Hwy 2	East
20070224	2007	February	24	I-29	South
20070224	2007	February	24	I-29	North
20070225	2007	February	25	Hwy 2	West
20070225	2007	February	25	Hwy 2	East
20070225	2007	February	25	I-29	South
20070225	2007	February	25	I-29	North
20070301	2007	March	1	Hwy 2	West
20070301	2007	March	1	Hwy 2	East
20070301	2007	March	1	I-29	South
20070301	2007	March	1	I-29	North
20070302	2007	March	2	I-29	South
20070302	2007	March	2	I-29	North
20070302	2007	March	2	Hwy 2	West
20070302	2007	March	2	Hwy 2	East
20070306	2007	March	6	Hwy 2	West/east
20070306	2007	March	6	I-29	South
20070306	2007	March	6	I-29	North
20070308	2007	March	8	Hwy 2	West
20070308	2007	March	8	Hwy 2	East

NOTE: Very few events were optimum for inclusion into the blowing snow events.

(continued on next page)

TABLE 2 (continued) Summary of Research Events Conducted for Blowing Snow Susceptibility Index Development During Winter 2006–2007

Date	Year	Month	Day	Highway	Direction
20070315	2007	March	15	Hwy 2	West
20070315	2007	March	15	Hwy 2	East
20070315	2007	March	15	I-29	South
20070315	2007	March	15	I-29	North
20070401	2007	April	1	Hwy 2	West
20070401	2007	April	1	Hwy 2	East
20070401	2007	April	1	I-29	South
20070401	2007	April	1	I-29	North
20070403	2007	April	3	Hwy 2	West
20070403	2007	April	3	Hwy 2	East
20070403	2007	April	3	I-29	South
20070403	2007	April	3	I-29	North

NOTE: Very few events were optimum for inclusion into the blowing snow events.

since there was a significant length of urban area along the roadway. It was our hypothesis that those areas with vegetation (both major and/or minor) next to the roadway would have less blowing snow as opposed to those areas that did not. As seen in Table 3 the I-29 corridor shows a positive correlation with this hypothesis, but the US-2 corridor shows a negative correlation. These results are inconclusive and are most likely due to the small sample size of the events.

A second analysis looked at the relevance of open space between the roadway and environmental obstructions. A fetch distance was measured perpendicular to the roadway as a possible effect on blowing snow occurrences (Table 4). This fetch distance indicates the amount of open area between the location of the environmental obstructions and the roadway. The

TABLE 3 Aggregated Pixel Count of Blowing Snow Occurrences Versus No Blowing Snow Occurrences for Three Events

I-29 Southbound				
	Yes Snow	No Snow	% Yes	% No
veg1cat0	288	141	67	33
veg0cat1	380	57	87	13
veg1cat1	84	24	78	22
veg0cat0	965	240	80	20
U.S. Highway 2 Westbound				
	Yes Snow	No Snow	% Yes	% No
veg1urb0	358	831	30	70
veg0urb1	224	258	46	54
veg1urb1	39	135	22	78
veg0urb0	1069	1029	51	49

**TABLE 4 Fetch Distance Versus Blowing Snow Occurrences
Considering Major Obstructions**

Fetch (miles)	Pixel Count—All	Pixel Count—Snow	% Occurrence
0.00	125	31	25
0.13	16	0	0
0.25	129	0	0
0.50	191	40	21
0.75	56	9	16
1.00	213	15	7
1.25	82	7	9
1.50	84	33	39
2.00	359	20	6

hypothesis for this was that those areas with a larger fetch would have more blowing snow because of the ability for the transport of snow over the entire distance. These findings do not show a distinct correlation over all the distances but the small fetch distance immediately near the roadway of 0.00, 0.13, and 0.25 indicate that it is the vegetation located near to the roadway that has the most effect. At greater distances the results are not conclusive.

SUMMARY AND FINDINGS

With the results shown for the roadway segments it proves that our findings are inclusive. This is most likely due to the small data sample from collected events. Collecting more events will hopefully improve our findings. Other factors also have to be taken into account in subsequent events such as the predominant wind direction, road orientation, and elevations along the roadway if possible. Future work will need to look into an automated method for defining the height of the obstructions along the roadway, which would include both the vegetation height and the bare earth elevations. A high resolution LiDAR digital elevation model would serve this purpose well with respect to both the bare earth elevation and vegetation height calculations.

RESEARCH

Because of the temporal changes to the roadway minor vegetation, all segments have been remapped during the fall of 2007. In order to help develop a better data set for more accurate blowing snow modeling and to identify a correlation between blowing snow and roadway vegetation, variables such as wind speed and direction, snow pack conditions, and holding capacity would be added to the event parameters.

During the upcoming season the mapping of blowing snow for all segments will be mapped on an event basis. The 2-mi segment (I-29, North of Thompson Exit) will be monitored closely, with the addition of snow stake measurements (approved by the North Dakota Department of Transportation). This comparison of mowed vegetation and non-mowed vegetation (specifically cattails) will be monitored by event and on a scheduled weekly basis. This experiment is to evaluate the holding capacity of the vegetation within the adjacent ditch.

Since the topography in the Red River Valley region of eastern North Dakota is very subtle, a future data set of interest would be a high resolution and accurate digital elevation model such as those collected by LiDAR. This high frequency collection would also enable a more accurate mapping of major vegetation along the roadway.

ACKNOWLEDGMENTS

This work is supported under the Federal Highway Administration's Sponsored Research Program Funds through the North Dakota Department of Transportation and under the U.S. Department of Agriculture-funded Rural Geospatial Innovations.

REFERENCES

Ahrens, C. D. *Meteorology Today: An Introduction to Weather, Climate, and the Environment*. 6th ed. Brooks/Cole, 2000, pp. 244–249.

BLOWING AND DRIFTING SNOW

**Spatial Modeling for Evaluation and Remediation
of Snow Drifting on Ontario Highways****MAX S. PERCHANOK***Ontario Ministry of Transportation***STEVE MCARDLE****PATRICK GROVER****ALEKSEY NAUMOV***4DM Inc.*

Drifting snow is responsible for up to 30% of the plowing and salting trips on Ontario, Canada, highways. In many cases road design and infrastructure features can mitigate this, but their inclusion in highway planning is difficult because suitable modeling tools are not available. The purpose of this study is to implement numerical snow drifting models with engineering design principles on a geographic information system spatial platform. The models were implemented as a simulation, executed at 1-h time steps through a 1-year design storm for a series of 1-km study sites along two highway maintenance routes. Model output showed the hourly flux and total accumulation along transects at the highway centerline as well as across the right of way. The model classified zones of increased drifting risk associated with open terrain and roadside obstructions. An iterative process was used to estimate changes in snow accumulation to optimize remedial treatments. The system can be applied to a wide range of highway design and maintenance applications, such as identifying potential drift-prone locations during highway planning, providing an objective basis for prioritizing expenditure on remediation, and predicting local variations in demand for plows and road salt that are related to snow drifting.

Weather Sensors and Data Collection

WEATHER SENSORS AND DATA COLLECTION

Noninvasive Road Weather Sensors**PAUL BRIDGE***Vaisala, Inc.*

Many road authorities have invested in roadway weather information systems (RWIS), which provide data from locations around their road networks 24/7. Most of these systems are based on 30-year-old technology, in the form of sensors embedded in the road surface to provide information about surface conditions and temperature. Along with atmospheric sensors, the majority of these road weather stations provide authorities with information to help tackle the problems of ice and snow. The 2003 American Meteorological Society Forum on Weather and Highways noted that RWIS significantly benefit highway maintenance operations, particularly winter maintenance. The consensus of transport professionals was that there would be clear benefits from a denser network of road weather observation sites. At the same time it recognized that deployment of RWIS has been limited by their cost and the strong competition for limited funds within state departments of transportation. The recent introduction of noninvasive road temperature and condition sensors is providing a cost effective solution for authorities to both obtain improved road weather information and increase the density of RWIS observations. This paper explores the applications and benefits of non-intrusive road sensors with a particular focus on (a) winter maintenance key performance indicators, (b) decreasing environmental impact of deicing agents, and (c) sensor deployment.

Traditional roadway weather information systems (RWIS) comprise of sensor stations, usually located close to the side of the road, also referred to as environmental sensing stations (ESS), see [Figure 1](#). These ESS collect and report various weather parameters to a central hub or server, where the data is then displayed or ingested into systems primarily for winter maintenance decision making.

Of the approximately 2,500 ESS deployed in the United States, the vast majority of the atmospheric sensors are mounted on dedicated 10-m masts, usually with concrete bases and enclosures. Some of the data from the atmospheric sensors is used for numerical modeling, for example air temperature and barometric pressure, while other parameters are used for decision making or triggering automated signs, for example wind, visibility, or present weather.

The sensors at the heart of providing road surface conditions (for winter maintenance in particular) are embedded road sensors, or “pucks” as they are known in the United States. These pucks essentially mimic the road surface and, depending on manufacturer, usually provide readings of

- Temperature,
- Surface state (dry, wet, frost, etc.),
- Depression of freezing point, and
- Chemical concentration.

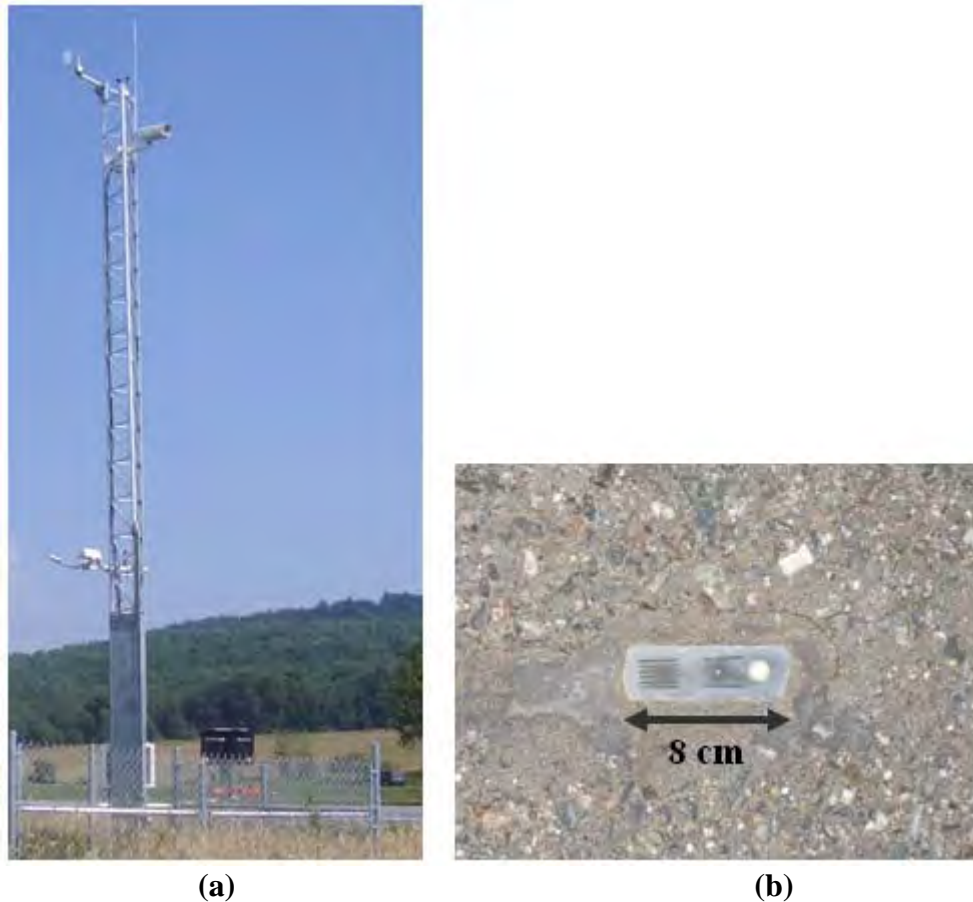

FIGURE 1 (a) Example of a traditional ESS set-up with a 10-m mast and (b) a close-up of an embedded road weather sensor in the pavement surface.

However surface pucks do not generally directly measure parameters such as frost or snow amount for example. These are usually calculated to be present by determining surface temperature and examining atmospheric conditions such as dew point to assess whether frost is present or not. Not surprisingly surface pucks are not always able to provide realistic measurements of the true road surface. Furthermore, it is also known that surface pucks can become depressed slightly below the road surface on occasion, which can lead to pooling of surface water or chemical solution, again giving rise to unrepresentative measurements.

NONINVASIVE TECHNOLOGY

In order to obtain improved road surface measurements, Vaisala has introduced two nonintrusive sensors which were developed in partnership with the Finnish Road Administration.

The capabilities of the nonintrusive optical sensors have already been tested and a number of papers have been published; one is called Vaisala Remote Road Surface State Sensor DSC111 and the other Vaisala Remote Road Surface Temperature Sensor DST111. These sensors are remote in the sense that they can be installed on any post by the roadside or a gantry

across the road (Figure 2). Thus installation is fully nonintrusive, i.e., there is no need to install anything on the road surface.

DST111 is based on measuring long wave infrared radiation between the detector of the instrument and a selected location on the road surface. If this radiation is in balance, then the temperature of the detector and the road surface are equal whereas a nonbalance can be calibrated to a known temperature difference. However, this method applied such measures as the apparent radiation temperature, which can be offset by many degrees due to reflection of long wave infrared radiation at the road surface. In DST111 these reflection induced errors are minimized by properly selecting the range of wavelengths in use. The accuracy of the DST111 is within 0.3°C in typical icing conditions.

DSC111 is based on active transmission of an infrared light beam on the road surface and detection of the backscattered signal at selected wavelengths. Most of the backscattered light has traversed through a possible surface layer of water or ice. By proper selection of wavelength it is possible to observe absorption of water and ice practically independently of each other. Since white ice, i.e., snow or hoar frost, reflects light much better than black ice, these two main types of ice can be distinguished as well. The observed absorption signal is readily transformable to water layer, to ice layer, or to snow and frost amount in millimeters of water equivalent. With this information it is straightforward to determine the surface state as dry, moist, wet, icy, snowy–frosty, or slushy. The information is obtained as a direct measurement and does not alter



FIGURE 2 Nonintrusive sensors mounted on an overhead gantry.

the surface state of the road, unlike some of the traditional pucks. It also turned out that it was possible to go one step further and model the apparent reduction of the friction coefficient due to ice and water on a road surface.

FRICITION MEASUREMENTS

It has been established that the DSC111 is able to provide a very good correlation between actually measured and modeled friction values in typical winter weather conditions (Figure 3).

Since the model has amount of water, ice, and snow–frost as input parameters, the effect of various types of ice on the apparent friction can be taken into account. For example, a slushy surface condition can have a reasonably high friction value although the amount of ice is fairly high. On the contrary, a very thin layer of ice can have a dramatic drop of friction especially if the ice is hard and does not contain salt. If there is salt, then ice will build up as a fragile structure with pores filled with salty solution and again friction may stay comparably high. This is the actual reason why nominally dilute solutions are effective in preventing slippery roads.

The RMS difference of the measured and modeled friction values is only 0.07 in friction units. We should take into account that this result is obtained without using surface temperature as a model parameter or measuring it at all while detecting the surface state. Naturally, more elaborate models could improve the result to some extent.

As previously mentioned, ESS are primarily installed in the first place to assist winter maintenance decision makers to take proper action at the right time in order to keep up safety on

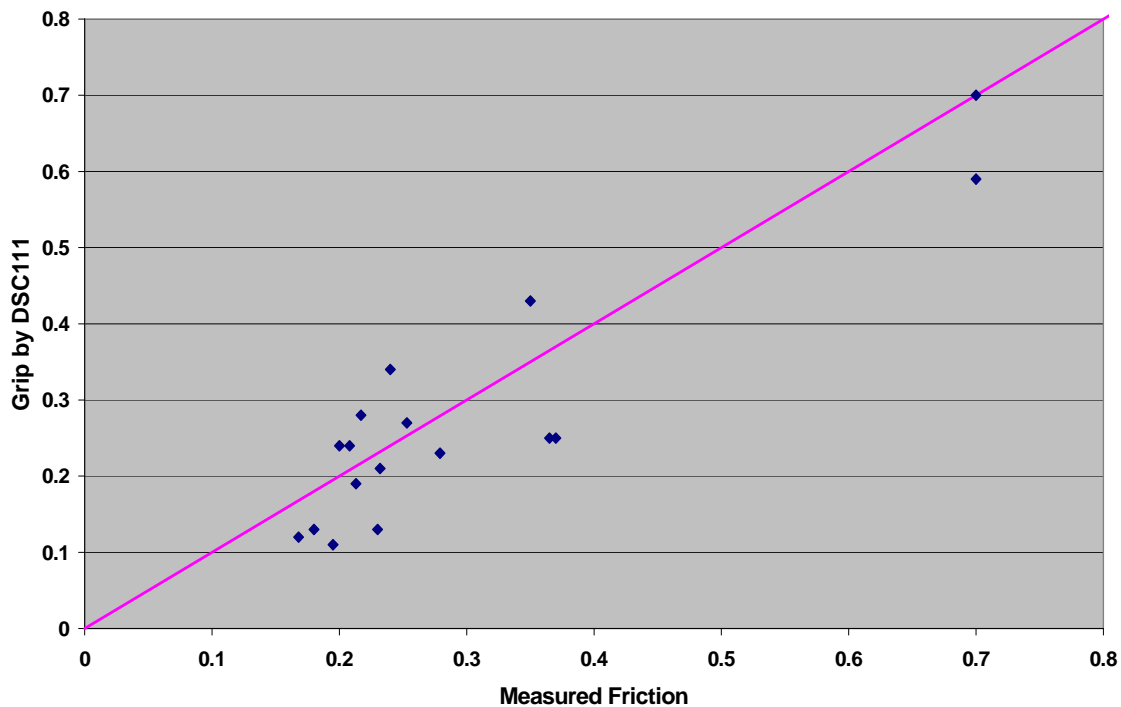

FIGURE 3 The modeled grip readings of DSC111 as a function of actual measured friction. The RMS difference is 0.07 units.

the roads and save costs of winter maintenance. To decide the right action and time one needs to have a forecast of weather as well. If we ask, what is the most essential information on the ESS for making the right decision? Our answer tends to be “road surface temperature and depression of freezing point.” The first would help to understand where we are going and the latter whether there will be ice formation. It turns out that since ice alone does not make road surfaces slick, it is more important to know which kind of ice it is and whether it reduces the friction. For example hoar frost, or white ice crystals, do not reduce the surface friction as much as transparent (black) ice.

We define the apparent friction as if a vehicle had a friction reading of 0.80 in locked braking on a dry surface. Naturally some vehicles could have higher or lower actual readings depending on a number of parameters like type of tires, roughness and type of road surface, speed, temperature, and many others. Our assumption here is that despite these factors the relative reduction of friction due to ice is not a strong function of these parameters, i.e., presence of ice is relatively more important than the other factors in describing the level of slipperiness. Practical evidence, e.g., accident statistics on icy roads, supports this assumption.

There is a simple physical explanation why salt or other deicers can effectively increase apparent friction on road surfaces, even though there may be a comparable amount of ice present. When ice starts to build up on a road surface with a salty solution present, the ice crystals reject salt and thus the solution around the ice crystals will become more concentrated. This increase in concentration stops the further buildup of ice assuming that the surface temperature does not reduce any further. In addition, ice formation releases heat to the surface, reducing the speed of icing even though the weather is cooling. In practice, our real life experience is that when ice buildup starts, there seems to be enough time to apply more salt or deicer before the surface is too slick.

The detection threshold of any kind of ice is small enough to enable a direct measure of slipperiness with the surface state sensor. This capability of measuring slickness in the form of a modeled friction reading is opening up new approaches to road weather applications. Ice alone does not make a road surface slick. Thus the relevant question is not what is the surface state but is the surface slick?

The above question is now being addressed by an increasing number of departments of transportation (DOT) and public works representatives, who are starting to utilize friction for winter maintenance operations. In addition, friction data are also being used to fill a void that has existed for years, namely how to objectively measure the success of winter maintenance operations.

WINTER MAINTENANCE KEY PERFORMANCE INDICATOR

Transportation authorities use a variety of parameters to measure the success, or otherwise, of their winter maintenance operations. These include, but are not limited to

1. Number of road accidents reported,
2. Traffic flow,
3. Time taken to return the road network to bare pavement,
4. Amount of deicing chemical used,
5. Number of complaints received from the public, and
6. Friction.

Most of these performance indicators are fairly subjective, as a number of other parameters can also affect the various “measures.” However friction measurements are proving to be a far more objective method, especially with the increasing trend of DOTs to contract out winter maintenance operations. This has led to a requirement to ensure a fair and independent way to establish a key performance indicator to the effectiveness of winter maintenance operations.

In addition to the above, there are a growing number of other application areas for nonintrusive sensor technology that are now opening up that will be mentioned in the summary. Amongst these we have already begun trials of triggering spray systems utilizing friction.

FIXED AUTOMATED SPRAY TECHNOLOGY

Frost development on inland bridge decks is usually more prevalent than on surrounding road networks (see Figure 4) for two main reasons:

1. Inland bridge decks are on average 2°C to 3°C colder than surrounding roads early in the winter season due to heat loss.
2. Often bridge decks are close to sources of extra available water vapor.

For these reasons, frost usually develops earlier on bridge decks than surrounding roads and for a longer period with a greater frost build-up. This has led to an increasing number of



FIGURE 4 Ice remains on a bridge deck while approach roads are clear.

instances of fixed automated spray technology (FAST) being deployed on bridge decks (and other problematic locations, such as steep grades), whereby deicing chemicals are sprayed automatically when certain thresholds are met. Normally this is freezing point depression, and this in turn can lead to an overuse of chemical deicers, which in turn leads to a greater direct runoff into nearby water courses.

Currently available automatic deicer spraying systems are typically built on detecting depression of freezing point and comparing that to measured surface temperature. Technically this logic can work safely assuming those parameters are measured correctly. However, the actual needed amount of deicer is fundamentally less than what the depression of freezing point indicates. Vaisala has developed a control logic based on friction that should save both chemicals and associated costs, since the deicer tanks will not need filling up so frequently.

ENVIRONMENTAL IMPACTS OF DEICING AGENTS

Most authorities are coming under increasing pressure to minimize the economic and environmental impacts of winter maintenance, particularly the use of deicing agents. There are numerous papers published highlighting the damage and risks posed by deicing agents, such as Environment Canada, stating that road salts are entering the environment in large amounts and are posing a risk to plants, animals, birds, fish, lake and stream ecosystems, and groundwater. A few of the salient points include

- Damage to vegetation can occur up to 200 m from roadways that are treated with deicing salts.
- Up to 50.8% of woody plant species are sensitive to NaCl, and many of these have disappeared from Canadian roadsides.
- Of the 15 principal tree genera occurring in Canadian forests, 11 have been rated as sensitive to road salt. Approximately 55% of road salt chlorides are transported in surface runoff with the remaining 45% infiltrating through soils and into groundwater aquifers.
- Growing concern over the impact of road salt is not limited to Canada. California and Nevada currently restrict road salt use in certain areas to reduce chloride injury to roadside trees. Massachusetts turned to alternative road deicing to prevent sodium contamination of residential drinking wells. New York State legislators recently proposed a pilot study in the New York City watershed to examine road-salt alternatives that might be more protective of drinking-water quality.

Nonintrusive sensors supply more accurate information to help municipalities to improve their salt management programs, optimize de-icing operations, and balance the needs of wintertime mobility and safety with environmental concerns.

NONINTRUSIVE SENSOR INSTALLATION

It has already been mentioned that most of the traditional ESS currently deployed in the United States are mounted on dedicated 10-m masts, usually constructed on poured concrete bases. Since there is no requirement for the associated atmospheric data for the operation of the

nonintrusive sensors, we do not necessarily have to utilize dedicated structures. Also the embedded pucks have to be “cut” in to the road, which also means that the road has to be closed with the necessary traffic management in place and the associated dangers due to the exposure of the workforce. By comparison, nonintrusive road sensors can be mounted on existing street furniture, as in [Figure 5](#), which dramatically cuts down on installation costs. This is extremely pertinent to smaller authorities, such as public works departments, many of whom have very tight budgets.

Nonintrusive sensors can also be installed at any time of the year, regardless of weather, so that should a sensor fail it can be swapped out almost immediately, thus reducing downtime. This can be particularly important where redundancy is critical, as in some instances it has proven impossible to replace embedded sensors for a number of months during the winter due to subzero temperatures and adverse weather.

There is no requirement to replace non-intrusive sensors when the pavement is resurfaced; also the sensors can be moved to a different location, should the need arise.

SUMMARY

There are nearly 300 Vaisala nonintrusive sensors in over a dozen countries now deployed in the field, with over 50 of these units in the United States (December 2007). The ease and low cost of the install is allowing a growing network of RWIS, particularly for smaller transportation authorities.



FIGURE 5 Nonintrusive sensors mounted on existing street furniture in Chicago.

Furthermore, the high resolution of the DST111 and DSC111 to detect ice and changes in friction is allowing for the improvement and development of some new applications. Areas already being tried or considered include

- More accurate decision-making tool for winter maintenance,
- Automatic launching of management actions,
- Direct control of message signs,
- Weather adaptable speed limit systems,
- Key performance indicator for winter maintenance,
- Information for maintenance of sidewalks and car parks,
- Triggers for FAST,
- Intersection signal control, and
- Semi-mobile platforms: for example, emergency evacuation routes or study areas.

ACKNOWLEDGMENT

Taisto Haavasoja provided much of the sensor theoretical and validation information for this paper.

REFERENCES

- Badelt, H., J. Breitenstein, S. Scheurl, J. Fleish, G. Heusler, and A. Wendl. Entwicklung von Prüf- und Kalibriermethoden für Fahrbahnfeuchtesensoren, Abschlussbericht zum Projekt 99653, BAST Februar, 2002.
- Nicolas, J.-P. Glättebildung durch Überfrieren. Schwellwerte der Oberflächen-feuchte auf Fahrbahnen. Bast Heft V 36, 1996.
- Pilli-Sihvola, Y., K. Toivonen, T. Haavasoja, V. Haavisto, and P. Nylander. SIRWEC Torino, Italy, 2006.
- Priority Substances List Assessment Report*. Environment Canada, 2001.

WEATHER SENSORS AND DATA COLLECTION

Using the Probe Vehicle to Gather Information on Visibility in Snowstorms

MASARU MATSUZAWA

YASUHIKO KAJIYA

YUMA MATSUYAMA

Civil Engineering Research Institute for Cold Region, Public Works Research Institute

TAKASHI NISHIDA

Subaru Technical Research Center, Fuji Heavy Industries Ltd.

YASUHIRO NAGATA

Japan Weather Association

In recent years, many countries have been developing systems that use probe vehicles to determine rainfall intensity, road surface conditions, and other aspects of the road travel environment. This research studied the feasibility of using windshield wiper and lamps operation data as information on visibility in snowstorms. A test probe vehicle (Subaru Legacy) is able to record vehicle location, travel speed, and use of windshield wipers and lamps. The vehicle was lent to a female driver to commute the roughly 20 km from her home to her workplace. In addition, four vehicles, all of the type used in the previous test, were used for another test in the city of Sapporo and its suburbs between February and March 2007. The vehicles were driven by employees of Hokkaido Subaru Co., Ltd. on company business. The tests showed that the data on wiper activation in the daylight hours can be used to determine visibility range and identify snowfall. The data on side lamp activation cannot be used to determine visibility range, but can be used to identify snowfall. For the evening hours, it was difficult to identify visibility and snowfall by means of the data on side lamp activation. But the data on wiper activation could determine visibility range and identify snowfall.

Probe vehicles are used for collecting information on traffic congestion and road travel speeds. In recent years, many countries have been developing systems that use probe vehicles to determine rainfall intensity, road surface conditions, and other aspects of the road travel environment, as typified by the vehicle infrastructure integration of the U.S. Department of Transportation. Information collected by probe vehicles is used for winter road maintenance and road traveler information services (1–5).

Studies have investigated the possibility of using information from the windshield wiper system to detect thunderstorms and of using information from the antilock braking system to evaluate road surface slipperiness (6, 7). Probe vehicles have rarely been used for estimating visibility and snowfall intensity. This study focuses on the feasibility of detecting reduced visibility and snowfall intensity from information on the use of the wipers, headlamps, and side lamps of probe vehicles.

OUTLINE OF THE TRAVELING TEST

The probe vehicle used for this study was developed by the Subaru Technical Research Center. It is a Subaru Legacy mounted with a Global Positioning System and with instruments for collecting data on driving behavior. The measurement items are shown in Table 1. The measurement data were recorded on compact flash cards in a data logger.

The test subject, a woman in her 50s, was asked to use the probe vehicle in commuting between home and work on weekdays from the evening of February 2 to the morning of February 20, 2007. Her uncorrected visual acuity was 1.2 for both eyes in the decimal system.

The subject drove the roughly 20 km from her home in the Aino-sato district of northern Sapporo, where snowstorms occur frequently, to her workplace downtown (North 4, West 23; Chuo ward) (Figure 1). She was not informed of the purpose of the test, so that she would not be self-conscious about the timing of her wiper and the headlamp activation. It took less than 1 h for her to commute each way, and she drove the outbound leg between the morning hours of 8:30 and 9:30 and the return leg between the evening hours of 17:00 and 18:00. The sunrise and the sunset on February 2, 2007, were at 6:50 and 16:47, and those on February 20, 2007, were at 6:26 and 17:11. On mornings of clear weather, the subject did not have to use the headlamps while driving. She needed the headlamps when she drove home in the evening and on some mornings without clear weather. Japanese law does not require drivers to use headlamps during rainfall or snowfall.

A digital video camera placed in the front passenger seat videotaped the visibility while she was driving. The visibility was later classified visually into five ranges: 50–100 m, 100–200 m, 200–500 m, 500–1,000 m, and >1,000 m.

DETERMINING SNOWFALL INTENSITY

Data Analysis

During seven of the 22 one-way trips, visibility of <1,000 m occurred (Table 2). For these trips, wiper and lamp activation was examined in relation to visibility at the time of activation. Data collection instruments distinguish only “ON” and “OFF” for wiper activation. By interpreting the patterns of activation, “ON” was subdivided into “ON: Intermittent” and “ON: Slow.”

In light of the differences between daytime and dusk driving, the data were analyzed separately for morning and evening. The probe data from the 7 travels with visibility of <1,000 m (Table 2) were sampled at 1-s intervals. The video image showed that the subject stopped the wipers whenever she stopped at a traffic light. Thus the probe data at the travel velocity of 0 km/h

TABLE 1 Items Measured by the Probe Vehicle

Measurement Item	Data	Sampling Interval
Date and Time	Month/day/year; hour/minute/second	0.1 s
Vehicle Location	Latitude/longitude	1.0 s
Travel Speed	Speed (measured for four wheels)	0.1 s
Wiper Activation	On/off	0.1 s
Use of Lamps	Side lamps/low beams/high beams/off	0.1 s



FIGURE 1 The study area and the typical commuting route.

TABLE 2 Trips Used for Analysis (Date, Snowfall, Visibility)

Run No.	Measurement Date	Time of Day	Snowfall and Visibility	
			Snowfall? (yes/no)	Worst Visibility Range
6	Feb. 7, 2007	Morning	Yes	50–100 m
7	Feb. 7, 2007	Evening	Yes	500–1,000 m
11	Feb. 9, 2007	Evening	Yes	500–1,000 m
12	Feb. 13, 2007	Morning	Yes	200–500 m
15	Feb. 14, 2007	Evening	Yes	100–200 m
20	Feb. 19, 2007	Morning	Yes	500–1,000 m
22	Feb. 20, 2007	Morning	Yes	500–1,000 m

were eliminated. The data during periods without wiper movement were also eliminated from the analysis. The remaining data were used to examine the relationship between visibility range and the use of the wipers, headlamps, and side lamps.

Case Study

Figure 2 shows the data collected on the morning of February 7. When the subject left her home in the morning, the visibility range was 500 to 1,000 m. She used the wipers and side lamps. After Point A in Figure 2, she used the wipers less often than before Point A, because the visibility

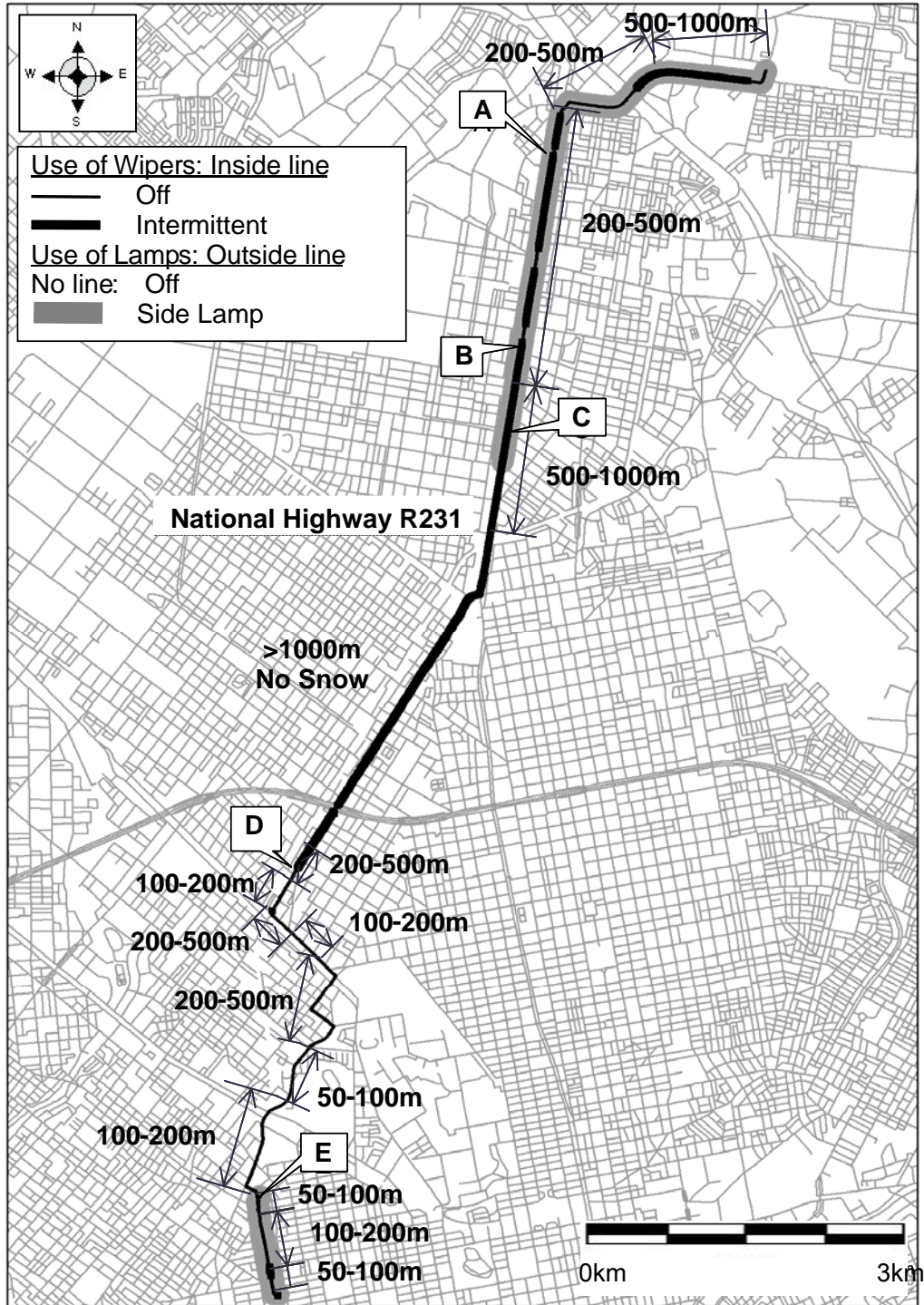

FIGURE 2 Visibility on different sections, and use of lamps and wipers on the morning of February 7, 2007.

improved. She stopped using the wipers at Point B, where snow was no longer falling. Even as far as Point C, however, the side lamps remained on, despite the better visibility. This suggests that she forgot to turn them off. The subject reactivated the wipers immediately when snow began to fall at Point D. She turned on the side lamps again when the visibility decreased to <100 m at Point E.

Use of Wipers and Visibility

The relationship between use of wiper and visibility range is shown in Figure 3 and Figure 4 for morning and evening, respectively.

Figure 3 shows that in the morning the wipers were either “OFF” or “ON: Intermittent.” As the visibility decreases the rate of “ON: Intermittent” data points increases. The wipers status is “ON: Intermittent” for most of the data points recorded when the visibility was <200 m. The wipers status is “ON: Intermittent” whenever the visibility range is 50 to 100 m.

In Figure 4, for the evening, the relationship between use of wipers and visibility is not as clear as in Figure 3. Data points for “ON: Slow” are too few for accurate analysis. Rate of “ON: Intermittent” when the visibility is <500 m exceeds those of when the visibility is >500 m. This suggests that data on the use of wipers can be used to determine when a snowstorm is intense enough to reduce the visibility range to <500 m.

Use of Lamps and Visibility

During the evening return travel leg, the subject activated the headlamps and side lamps irrespective of the visibility. When the subject was driving to work in the morning, she activated

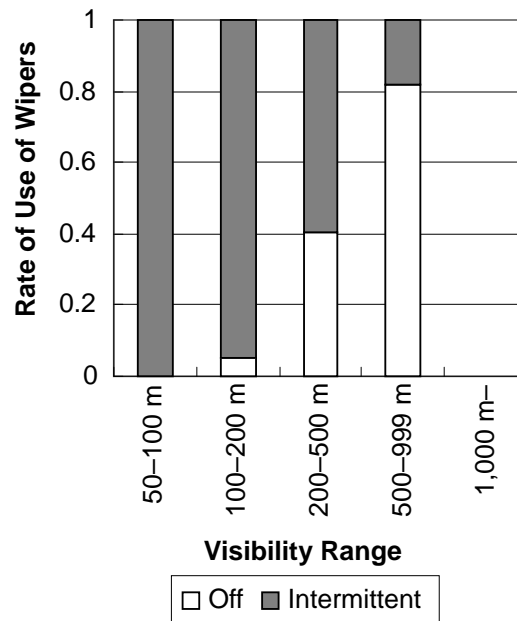

FIGURE 3 Visibility and use of wipers in the morning.

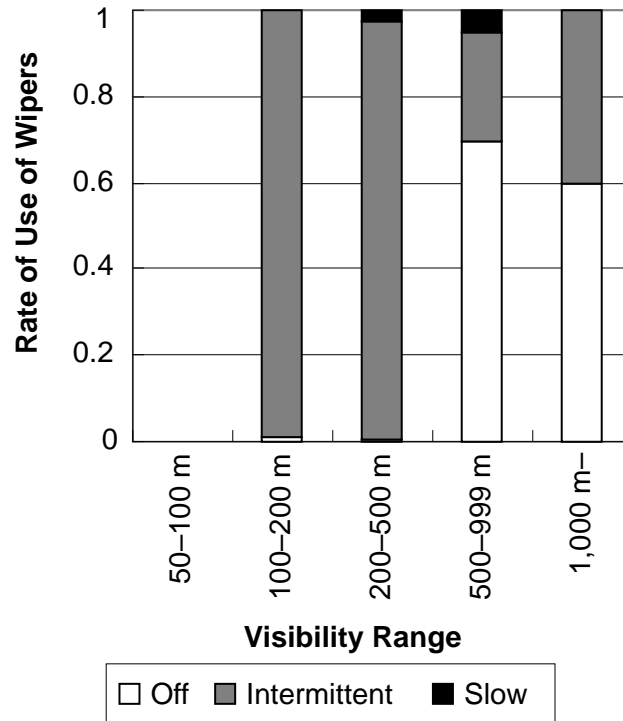

FIGURE 4 Visibility and use of wipers in the evening.

the side lamps at times, but never the headlamps. For this reason, as shown in Figure 5, this study examines only the relationship between visibility and the use of side lamps in the morning. We defined the “rate of use of side lamps” as the percent of travel time during which side lamps were activated. The rate of use of side lamps was 30% to 50% under visibilities of <500 m, but <5% under visibilities of >500 m. This suggests that side lamp activation data can be used for detecting snowstorms.

When the visibility is less than 500 m, however, the rate of use of side lamps does not increase with decreases in visibility. The relationship between the use of side lamps and visibility is less clear than that between the use of wipers and visibility (Figure 5).

One reason for this less clear relationship is that, under snowfall, drivers activate the wipers before they consider activating side lamps. During snowfall, drivers use the wipers to remove the visibility obstruction of snowflakes stuck to the windshield. During daytime hours, they turn on the headlamps and side lamps only when they consider it necessary to make their presence known to leading vehicles, following vehicles and pedestrians. The decision to activate the lamps is less immediate than that to activate the wipers, because the lamps do not affect the traveling conditions as directly as snowflakes on the windshield do. Additionally, drivers may forget to turn off the lamps after visibility improves, which also makes the relationship between the use of side lamps and visibility less clear.

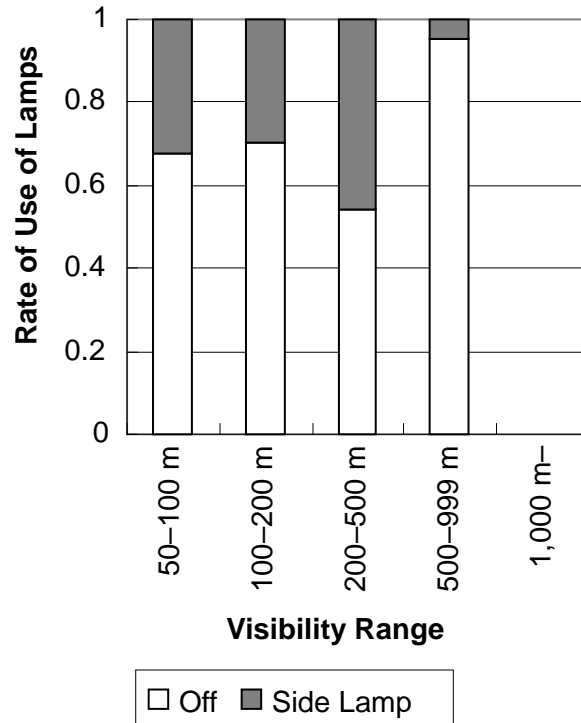

FIGURE 5 Visibility and use of lamps in the morning.

STUDY TOWARD REAL-TIME DETECTION OF SNOWSTORMS

Data for the Study

The preceding section indicates that it is possible to identify snowstorms from data on wiper and lamp activation. But the test was done with only one subject. Differences among drivers must be taken into account. Furthermore, to use probe data for real-time detection of snowstorms, it is necessary to analyze data sent from probe vehicles while they are still on the road.

Thus, four vehicles, all of the type used in the previous test, were used for another test in the city of Sapporo and its suburbs between February and March 2007. The measurement items were travel speed, vehicle location, wiper activation (ON and OFF) and lamp activation (side lamps, low beams, high beams and OFF). The data sampling interval was 2 s, and the data were sent over cell phone lines to a server at the Subaru Technical Research Center every 120 s. The vehicles were driven by employees of Hokkaido Subaru Co., Ltd. on company business; thus, the number of subjects and their attributes are unknown, and the driving routes are unspecified. The trips were not videotaped.

The data from February 12 to 14 and March 12 to 14 were extracted for analysis, because snow fell on those days. Time series change of snowfall intensity and visibility range were matched with the probe data. Because videotaping was not conducted, the data on snowfall intensity were taken from 1-km-mesh weather information provided by the Japan Weather Association. The visibility range was estimated by inputting air temperature, wind velocity and snowfall intensity into an estimation equation proposed by Matsuzawa and Takeuchi (8). Probe

data on vehicle locations were used to identify the meshes where the vehicles had traveled, and snowfall intensity and visibility were determined for each mesh. Snowfall intensity is in centimeters per hour, and visibility range is a 1-h mean.

When wipers are not moving at the time of sampling, an “OFF” signal is sent. But that sampling moment can fall between intermittent movements of the wipers, which would make the “OFF” signal false. This study did not attempt to correct for such “OFF” signals.

Wiper Activation

First, the relationship between wiper use and snowfall was examined. The “wiper activation rate” in this study is defined as the percent of travel time during which wipers were activated. The wiper activation rate under Weather Condition A (e.g., hourly snowfall > 1 cm/h) is calculated as follows:

$$\text{activation rate} = (\text{number of “ON” signals under weather condition A}) / (\text{total number of signals under weather condition A})$$

Figure 6 shows the relationship between hourly snowfall and wiper activation rate. The wiper activation rate increases with increases in hourly snowfall. The wiper activation rate increases sharply when the hourly snowfall exceeds 1 cm.

Figure 7 shows the relationship between visibility range and wiper activation rate. The wiper activation rate increases with decreases in visibility. Although no data are available for visibility of <200 m, the results in Figure 7 are similar to those in Figure 3, which suggests that the wiper activation rate can be used for determining visibility and snowfall intensity.

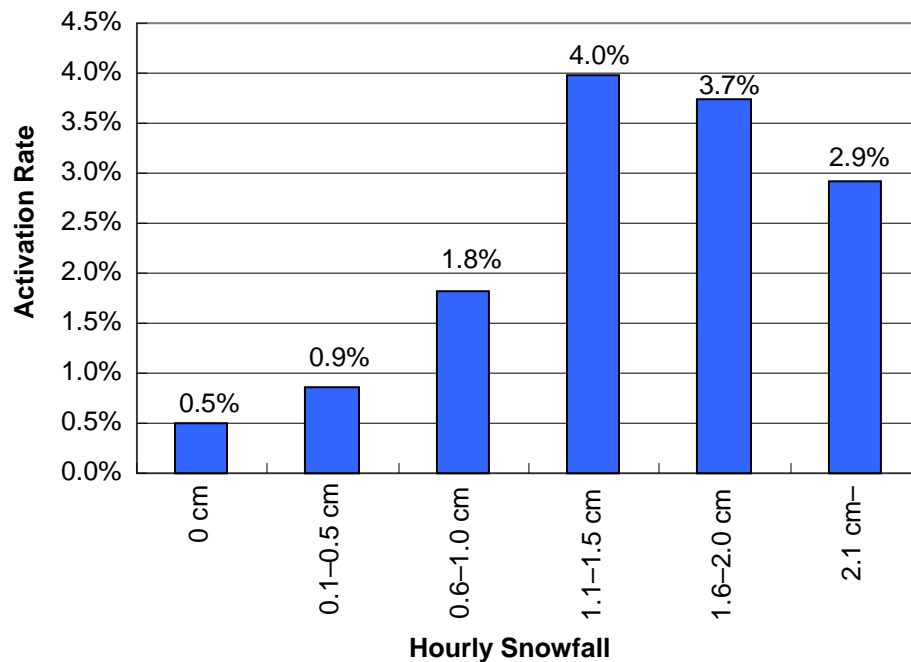

FIGURE 6 Hourly snowfall and wiper activation rate.

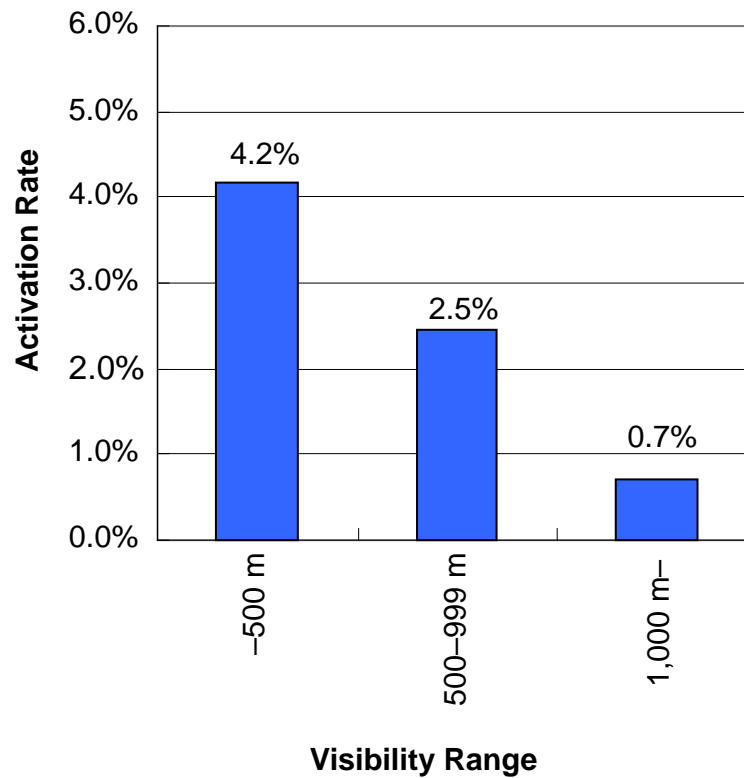

FIGURE 7 Visibility range and wiper activation rate.

Side Lamp Activation

The relationship between lamp use and snowstorms was examined. During nighttime hours, the headlamps and the side lamps are turned on all the time during driving, which makes it difficult to detect snowfall and poor visibility from the use of those lamps. Thus, analysis was done on the data collected during daytime hours. Because data on the headlamps use were not available, the use of the side lamps was examined in relation to hourly snowfall and visibility. The side lamp activation rate under Weather Condition A is calculated as follows:

$$\text{activation rate} = (\text{number of "ON" signals under weather condition A}) / (\text{total number of signals under weather condition A})$$

Figure 8 shows the relationship between hourly snowfall and the side lamp activation rate. The side lamp activation rate increases sharply when the hourly snowfall exceeds 1 cm.

Figure 9 shows the relationship between visibility and side lamp activation rate. The side lamp activation rate increases with decreases in visibility.

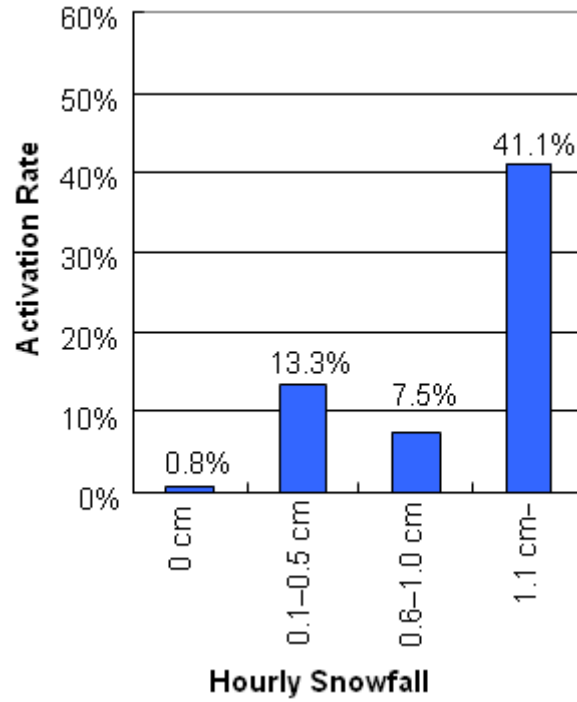

FIGURE 8 Hourly snowfall and side lamp activation rate.

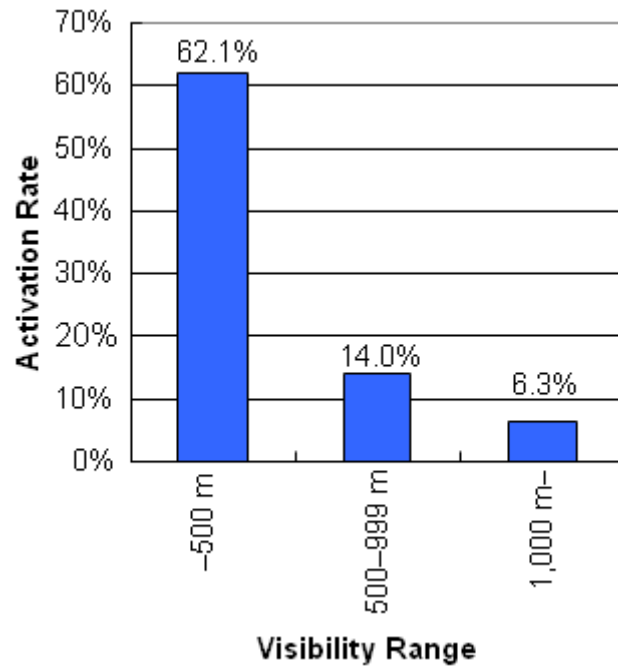

FIGURE 9 Visibility range and side lamp activation rate.

Concurrent Activation of Side Lamps and Wipers

In relation to visibility and hourly snowfall, the concurrent use of side lamps and wipers was examined. The “concurrent activation rate of side lamps and wipers” in this study is defined as the time when the subject used side lamps and wipers concurrently as a percent of total travel time. The data used for this analysis were only those collected during daytime hours.

Figure 10 shows the relationship between the concurrent activation rate of side lamps and wipers and hourly snowfall. It is shown that side lamps and wipers are rarely used concurrently when the hourly snowfall is <1.0 cm/h.

Figure 11 shows the relationship between the concurrent activation rate of side lamps and wipers and visibility range. At visibilities of <1,000 m, the concurrent activation rate is higher than at visibilities of >1,000 m. The data at visibility of <500 m are insufficient in number; additional data are needed.

CONCLUSION AND FUTURE STUDIES

Tests collected data on a subject’s use of wipers and lamps while driving. These tests showed that the data on wiper activation in the daylight hours can be used to determine visibility range and identify snowfall. The data on side lamp activation cannot be used to determine visibility range, but can be used to identify snowfall. For the evening hours, it was difficult to identify snowfall by means of the data on side lamp or headlamp activation. But the data on wiper activation can

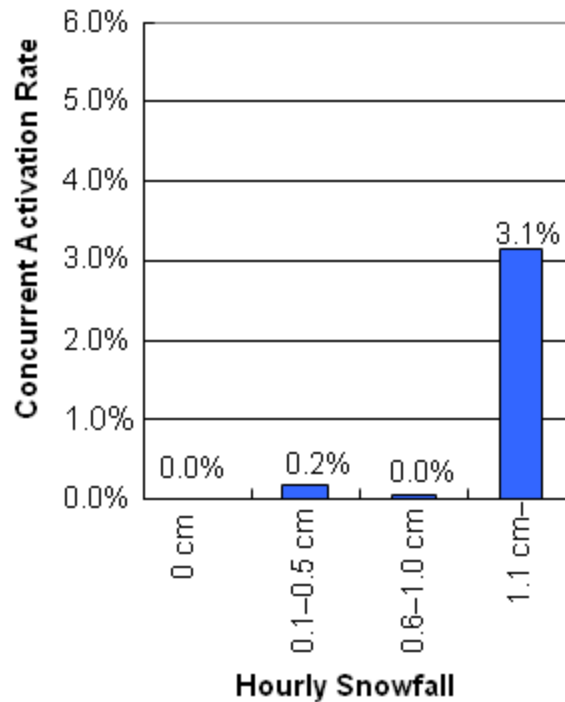

FIGURE 10 Concurrent activation rate of side lamps and wipers, and hourly snowfall.

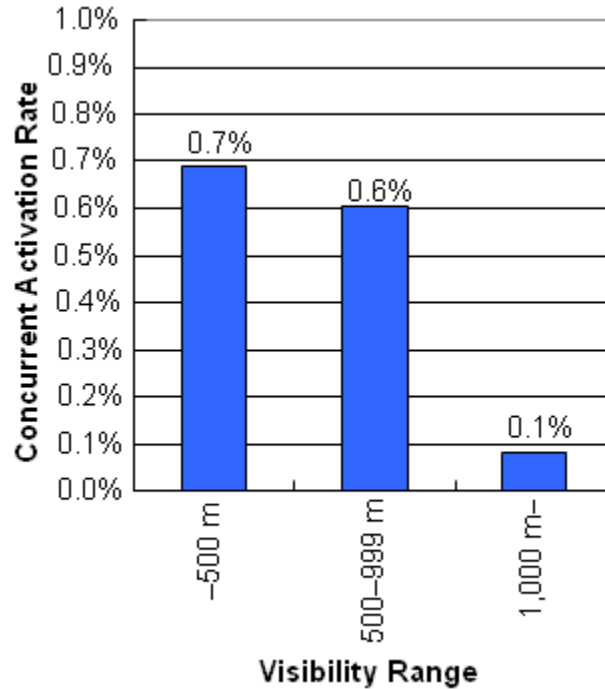

FIGURE 11 Concurrent activation rate of side lamps and wipers versus visibility range.

identify snowfall. In other words, snowfall can be identified during daylight hours and evening hours by examining the following data:

- Daylight hours: Data on wiper and side lamp activation.
- Evening hours: Data on wiper activation.

During intense snowfall, use of low beams often provides better visibility of the road ahead than use of high beams. In driving in the suburbs at night, data on headlamp activation may be used for identifying severe snowstorms.

In the first test, the data were collected from the driving behavior of only one test subject. In the second test, which used four probe vehicles and sampled data every 2 s, few data were collected for visibility <500 m. Future studies must include more test subjects and probe vehicles, and data need to be collected during snowstorms that reduce the visibility to less than 500 m. Based on the data from such studies, criteria for determining snowstorm occurrence and intensity must be clarified.

REFERENCES

1. Petty, K. R., and W. P. Mahoney III. *Weather Applications and Products Enabled Through Vehicle Infrastructure Integration (VII)—Feasibility and Concept Development Study*. FHWA-HOP-07-084. FHWA, U.S. Department of Transportation, January 2007.

2. Pilli-Sihvola, Y. Floating Car Road Weather Information Monitoring System. In *Transportation Research Record: Journal of the Transportation Research Board*, No. 1741, TRB, National Research Council, Washington, D.C., 2001, pp. 3–5.
3. Hanke, H. Winter Maintenance Management by the Use of Floating Car Data. *Proc., 12th PIARC Winter Road Congress*, Torino, March 26–30, 2006.
4. Honda Internavi Premium Club. <http://www.premium-club.jp/>. Accessed November 27, 2007 (in Japanese).
5. Toyota G-BOOK. mx: http://g-book.com/pc/whats_G-BOOK_mX/. Accessed November 27, 2007 (in Japanese).
6. Petty, K. R., and W. P. Mahoney III. Enhancing Road Weather Information Through Vehicle Infrastructure Integration. In *Transportation Research Record: Journal of the Transportation Research Board*, No. 2015, Transportation Research Board of the National Academies, Washington, D.C., 2007, pp. 132–140.
7. Nakatsuji T., I. Hayashi, P. Ranjitkar, T. Shirakawa, and A. Kawamura. Online Estimation of Friction Coefficients of Winter Road Surfaces Using the Unscented Kalman Filter. In *Transportation Research Record: Journal of the Transportation Research Board*, No. 2015, Transportation Research Board of the National Academies, Washington, D.C., 2007, pp. 113–122.
8. Matsuzawa, M., and M. Takeuchi. A Study of Methods to Estimate Visibility Based on Weather Conditions. *Seppyō*, Vol. 64, 2002, pp. 77–85 (in Japanese).

WEATHER SENSORS AND DATA COLLECTION

Operational Considerations in the Integration of Technologies for Automated Vehicle Location and Mobile Data Collection into Decision Support Systems for Maintenance and Operations

JOHN J. MEWES

ROBERT D. HART

BENJAMIN W. HERSHEY

LEON F. OSBORNE, JR.

Meridian Environmental Technology, Inc.

DAVID L. HUFT

South Dakota Department of Transportation

Mobile data collection (MDC) of maintenance, road and weather information from maintenance vehicles has become an important extension of automated vehicle location (AVL) technologies. The combination of AVL and MDC capabilities creates a valuable information resource to support winter maintenance and operations. The evolution of AVL–MDC provides for more effective assessment of the utilization of maintenance resources and a more streamlined process for collecting information on the condition of an agency’s road network. It can permit dynamic materials inventory control, equipment status, fleet deployment, and aid in assessing the availability of resources in emergency situations. Road condition and maintenance information collected via AVL–MDC systems can be passed directly to traveler information systems and maintenance decision support systems (MDSS), thus advancing the use and validity of information provided by various support technologies. In particular, the use of AVL–MDC can provide timely data for an MDSS program and thus improve maintenance recommendations by incorporating the expected effects of maintenance activities already performed. AVL–MDC systems can also serve as a mechanism for distributing information back into the maintenance vehicle, thus improving real-time decision making by the vehicle operator. This paper presents an overview of the types of data collected by AVL–MDC units, illustrate the overall benefit in an operational setting, and present some of the potential pitfalls of deployment as experienced by early adopters of the technology involved with the MDSS program. The paper also illustrates the importance of timely information during operations and how AVL–MDC can provide the data needed to make informed and intelligent decisions.

Considerable emphasis has been placed on the development of decision support systems to support highway maintenance and operations in recent years. Most of the emphasis to date has been placed upon the development of decision support systems for winter maintenance, such as the maintenance decision support system (MDSS) Functional Prototype (Pisano et al., 2005), developed jointly by FHWA and several national research laboratories, and the pooled-fund study (PFS) MDSS (Mewes et al., 2005). The PFS MDSS is the result of a collaborative effort between 13 state departments of transportation (DOTs), the FHWA Road Weather Management Program, the Aurora Road Weather Information System (RWIS) PFS, and Meridian Environmental Technology, Inc., the private-sector company that carries out the PFS MDSS research, development, and operations.

The goal of MDSS is to provide decision support to personnel involved in winter maintenance operations within DOTs. This support may include the provision of weather and

road temperature–condition analyses and forecasts for agency roads, integration of numerous disparate data sets into a cohesive tool allowing for seamless access and utilization of these data sets, and the provision of maintenance recommendations that are expected to maintain level of service requirements on agency roads.

A key finding of early interviews of the PFS MDSS project was that maintenance decisions were largely tactical in nature. That is, once the storm starts decisions are largely made on-the-fly to address real-time situations. As such, a strategic recommendation tool that could not accommodate real-time decision making once a storm started was viewed as having limited usefulness. Tactical decision making addresses the evolving situation in the “dynamic layer” (the layer of snow, ice, water, chemical, and abrasives atop the road) as a storm progresses. Real-time simulation of this evolving situation requires real-time flows of detailed information on the weather conditions a route is being exposed to as well as the maintenance activities that have been or are being carried out. While far from perfect, existing weather observation networks (such as RWIS and National Weather Service–FAA observing stations, weather radar, etc.) are able to provide satisfactory real-time information on the weather conditions on many winter maintenance routes. However, prior to the PFS MDSS, real-time reporting and utilization of maintenance activities were a very uncommon practice.

Without knowing what maintenance has already been performed it is very difficult to provide reasonable guidance on what additional maintenance activities should be carried out as a storm progresses. Because of this, the PFS MDSS made the accommodation of real-time maintenance activity and road condition reports a priority. Several methods of reporting have been utilized within the PFS MDSS. An early approach was to use a computer telephony system equipped with interactive voice response software to gather information from plow operators via cellular telephones. At the same time, a reporting tool was built into the initial release of the MDSS graphical user interface (GUI) that allowed this same information to be submitted electronically.

Fortunately, as communications and computing capabilities have improved the door has opened for collecting this information automatically using automated vehicle location (AVL) devices equipped with mobile data collection (MDC) capabilities. In this approach many of the activities of the snowplow are automatically recorded and reported back to the MDSS in real-time. Other information, such as road condition information, can be entered through simple touch screen interfaces in the truck. The MDC–AVL approach is widely recognized in the PFS MDSS member agencies as being the long-term solution to the reporting problem, but due to its implementation cost it is expected to take a considerable length of time for agencies to become fully equipped with MDC–AVL capabilities.

This paper presents an overview of the experiences of the PFS group with respect to utilization of MDC–AVL systems to support MDSS activities.

MDC–AVL DATA ELEMENTS AND CONSIDERATIONS TO SUPPORT MDSS

Data Elements

This section provides an overview of the data requirements from MDC–AVL platforms in order to adequately support MDSS needs. It is not intended to be all-encompassing, as each organization may have its own specific needs above and beyond those represented here.

Vehicle Identifier

This should be an identifier that is unique within the organization from which the data are being collected. It can be either textual or numeric. It does not need to be the same as the organization's vehicle identifier system, but a mapping between the MDC–AVL identifiers and that system should exist.

Time

This should be a complete description of the date and time of the report to within 1 second of accuracy. It can be in the form of a string (e.g., “1/20/2005 3:43 AM CST” or “1-20-2005 9:43 UTC”) or numeric (such as a Unix timestamp, which is a count of seconds since a certain point in history). In the former case the time string should be fully qualified to include the year, month, day, hour, minute, second, and time zone of the observation.

Location

Location information should be provided in the form of a Global Positioning System (GPS) latitude and longitude associated with the vehicle's location at the time of the report.

Direction of Travel (Optional)

This field should generally not be necessary provided that the accuracy of the location data and the frequency of reports are sufficient to determine the direction of travel at any given time. There is no universal formula available for making this determination, as it depends upon both the curviness of the road and the length of the normal maintenance runs in a given direction of travel.

Lane Identifier

This should be an identifier that can be used to uniquely determine the lane or lanes to which a report applies. A standard lane identification system across organizations is not necessary. However, an organization's lane identification system should be capable of representing both a single lane as well as combinations of lanes on a roadway. In general it is not yet practical to automatically assess lane information from GPS due to limitations in the accuracy of both GPS-based locations and the various lanes of agency road networks.

Maintenance Data

Plow Position This can be represented as a 0 or 1, or as a string (e.g., “up” or “down”). If the numeric representation is chosen a value of 0 is generally used to indicate that a particular piece of equipment is inactive, so a value of 0 would indicate plow up while a value of 1 would indicate plow down. This is not universally true, however, as the switches used to assess plow position (when automatically recorded) may dictate otherwise. Many snowplows have underbody scrapers and wings for which it may also be desirable to record positions.

Material Applied This field should uniquely describe the freeze-point depressant(s) and grit being applied to the roadway. Representation in the form of either a numerical or string identifier

is acceptable. In either case, the identifier itself need not fully describe the mixture so long as it is unique and can be associated with a more detailed description of the mixture at the time of processing. For example, if a garage uses a 20/80 mixture of granular NaCl and grit prewetted with 10 gal/ton of MgCl₂, the most efficient and straightforward way to convey this information might be to identify that particular mixture as something like “20/80 Salt/Sand Mix” in the MDC data files. The specific composition of this mixture should be available to those responsible for processing the data so that it can be interpreted appropriately. The reason for using an identification system instead of the specifics of the mixture is twofold. First, the complexity of some mixtures would necessitate carrying a large number of fields in the data file in order to accommodate the more complex cases. A second and related issue is that the increased data file size this would necessitate could pose problems for the limited bandwidth that may be available between the trucks and the data collection facility in a real-time setting.

Material Form This field could also be provided through the “Material Applied” field discussed above. However, in some existing systems the choices for “Material Applied” might be limited, e.g., to “NaCl” and not be descriptive of the form of that salt. In those cases this field should be present and populated with either a numerical or string identifier that indicates whether the material is in brine (liquid), prewet, or dry form.

Application Rate This field should represent the application rate of the material(s) being applied. It can be in the form of a string, a number, or a range of numbers. Units of mass per unit of lane length are generally preferred.

Application Rate Units This field should provide the units to associate with the application rate if they are not uniquely identifiable based upon the “Material Applied” field. For example, if “NaCl” is indicated as the material being applied, but the agency applies dry, prewet, and brine NaCl, the units to associate with the application rate become critical for correct interpretation of the MDC–AVL data.

Observations

Road Condition This field should represent the road condition to associate with each report from the MDC system. A numerical or string identifier for each condition is acceptable. The agency needs to work with those interpreting the data to understand the conditions being described by the agency’s road condition dictionary.

Road Temperature (Optional) This numeric field should contain infrared pavement temperature measurements to associate with each report.

Precipitation (Optional) This field should represent precipitation that is observed by the driver to be falling at the time and location of the report. A numerical or string identifier for various optional precipitation reports is acceptable. As with road condition reports, the agency must work with those responsible for interpreting the data to establish a common understanding of the meaning of various reports.

Visibility and Obstruction (Optional) This field should represent the visibility distance and the obstruction causing the visibility limitation (if any). This may include drifting snow, or drifting snow may be handled as a separate data element. The agency must work with those

responsible for interpreting the data to establish a common understanding of the meaning of various reports.

Air Temperature (Optional) This numeric field should contain air temperature measurements to associate with each report.

Data Collection and Communication Considerations

At this point in time the aforementioned MDC–AVL information is generally constructed and communicated in one of two ways. In one mode, all data elements are logged to a file at regular intervals (ranging from seconds up to no more than every 5 min) and distributed back to a central collection point for processing into MDSS. This is the most straightforward way of storing the data, but does require more data storage space and communications bandwidth. Alternatively, time and location data can be logged at regular intervals and the other data elements logged only when changes occur. For example, if the user enters a road condition of “wet” on a touchscreen, that entry and the time it was made would be recorded. The “wet” road condition would be assumed to be valid from that time/location forward until a different condition is entered, and would be associated with all locations and times during that period.

In the PFS MDSS system all data elements are attributed to each GPS location and time. If the data elements being recorded/reported are hidden from the operator’s view it can be easy for the operator to forget to update the manually recorded elements as conditions, lanes, or maintenance activities change. It has therefore been found to be advantageous for the currently reported value for each of the data elements to be prominently displayed on a touchscreen interface within the vehicle. This screen permits the operator to quickly identify what he or she is reporting and take appropriate actions to update the data elements as operations or conditions change.

As communications capabilities improve more MDC–AVL systems are able to relay data back to a central location in near real time. However, even if data can be streamed back from the trucks to a central collection point in near real time, it is imperative that the MDC–AVL system on each truck continues to record data regardless of whether or not it is in communications range. If the truck moves out of range for a period of time then reenters an area where communications are possible, all data collected during the period it was out of range should be sent back to the central collection point at that time.

APPLICATION OF MDC–AVL IN MDSS

MDC–AVL was recognized early in the PFS MDSS project as a potentially valuable technology that would enable automated reporting of information viewed as important to the support of tactical maintenance decision making. Unfortunately MDC–AVL systems were relatively rare in the PFS member agencies during the early phases of the PFS MDSS. However, the combined growth of wireless networks within the member states and the development of low-cost on-board computing capabilities have made the prospect of widespread MDC–AVL deployments a much more viable prospect over time. Several of the PFS member agencies have deployments in excess of 50 vehicles as of late 2007, with the intention of fleetwide deployment within just a few years.

Although MDC–AVL support and data processing is not central to the mission of the PFS MDSS project, MDSS was widely viewed within the PFS member agencies as the primary initial

impetus for MDC–AVL deployment. MDSS and MDC–AVL are mutually enabling technologies in that the value of either system alone is considerably diminished from the potential value they hold when working together as a system. Because of these considerations, software for assimilating and interpreting MDC–AVL data was developed during the PFS MDSS project. This software primarily performs the function of taking raw GPS-based data from touch screens within the trucks, the spreader controller, and any plow position sensors installed on the truck and turning that information into discrete “maintenance actions” and road condition reports for assimilation into MDSS. This process involves the mapping of GPS-based data to MDSS routes and segments, conversion from agency- and MDC–AVL-specific data dictionaries to standard MDSS variables, filtering of bad data, auto-identifying break points between maintenance actions (or maintenance “runs”), and aggregating the time-varying information obtained during those activities into route- or segment-as-a-whole values.

Information derived from MDC–AVL data is applied in the MDSS system in a number of ways. One function of the PFS MDSS is to maintain a running assessment of the condition of agency maintenance routes within the MDSS system. In the PFS MDSS this assessment is made by using a sophisticated mass and energy balance pavement model to simulate the processes responsible for the deposition, transformation, and removal of moisture (liquid or frozen) from the dynamic layer atop the roadway. The model is responsible for serving as the integration platform that brings known information about past and present weather conditions, maintenance activities, and traffic impacts together to generate the ongoing assessment of the condition of each maintenance route. The MDC–AVL data supports this process in many ways. Maintenance activities reported through the MDC–AVL system can be applied to impacted maintenance routes in MDSS, and the anticipated response of those roads to the maintenance performed can be simulated using the model (Figure 1). Road conditions being observed and reported through the MDC–AVL system can augment the assessed condition of the roads traversed by the truck (see Figure 1). Weather conditions reported through the MDC–AVL system can supplement other sources of weather information with in situ real-time observations. These observations can also be used to augment the assessed condition of the roads (by augmenting the weather conditions to which the road is assumed to be exposed), and can feed back valuable information to meteorologists tasked with creating the detailed weather forecasts required to support MDSS.

The basic steps in the attribution of MDC–AVL data to maintenance routes in MDSS is as follows:

1. Perform checks as to whether various data elements appear to be kept updated.
2. Convert data element values from the MDC–AVL vendor–agency dictionary to the standardized MDSS dictionary.
3. Find the location of the vehicle GPS coordinates relative to the agencies road network, utilizing the indicated lane as necessary.
4. Compare locations from successive reports, determine the most likely path of travel between reports, and apply reported data element values to all locations between the successive reports.
5. Look for logical break points in the MDC–AVL data for each maintenance route in order to group a series of reports into a cohesive maintenance action. This process might involve the comparison of the number of passes along the route relative to the number expected in a complete maintenance run, breaks in time, and other clues indicative of the completion of one maintenance cycle on the route.
6. Cull out extraneous information that arises from irregularities in the paths of travel of trucks maintaining the routes.

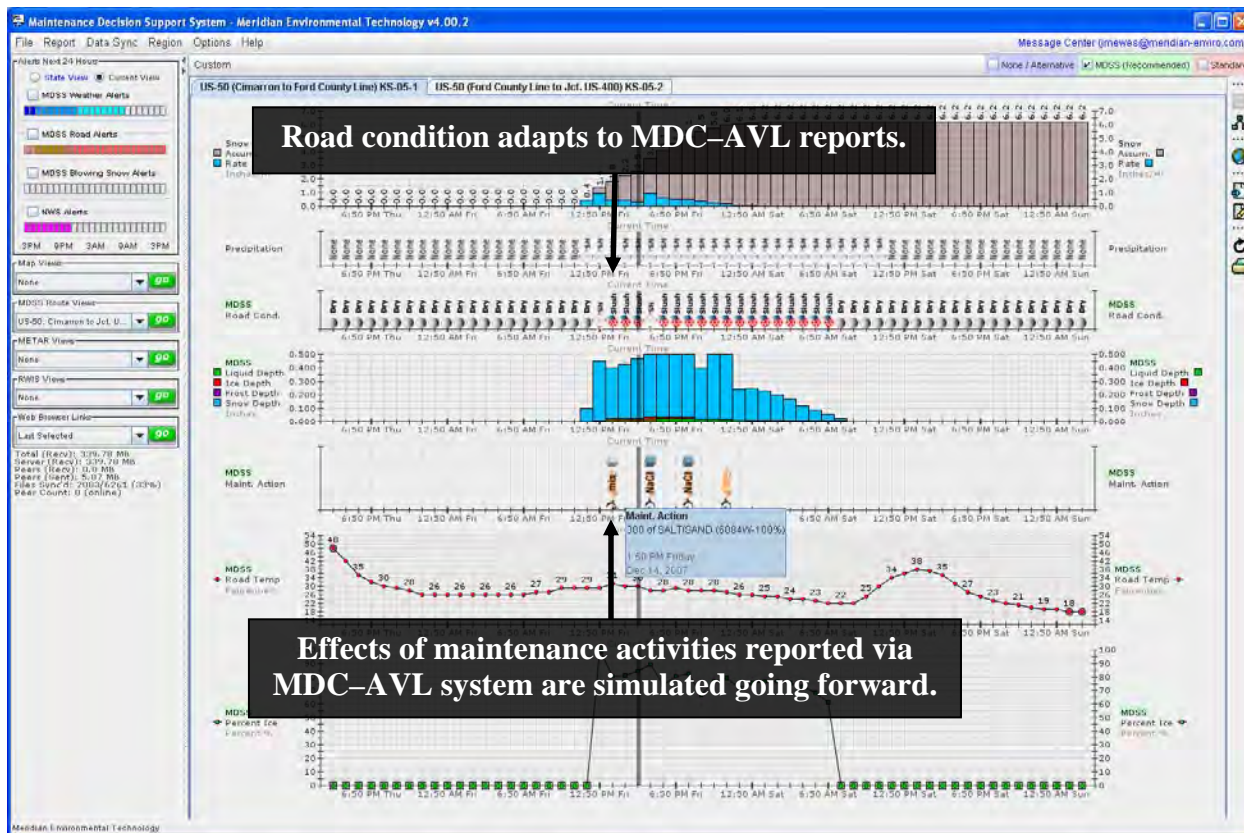

FIGURE 1 An example showing the pass of a snowplow across a maintenance route in the MDSS system. The specifics of the maintenance action are provided in the interface, and the current and forecast road conditions adapt to the reported road condition and the anticipated impacts of any deicing agents applied.

7. Average quantities and aggregate conditions for all reports between break points in order to derive the specifics of the maintenance action as seen from the view of the route as a whole.

This process of “up-scaling” MDC-AVL information to the level of the maintenance route, which is how most maintenance personnel are accustomed to receiving such information, can be straightforward or very complex depending upon the complexity of the route and the number of trucks typically involved in maintaining the route at a given time.

In recognition that fleet tracking and remote visualization of conditions are also valuable forms of winter maintenance decision support, the PFS MDSS GUI also provides various tools for visualization of snowplow locations relative to the storm, snowplow histories via route traces (Figure 2) and tabular storm reports, and even the provision of dashboard camera images collected in near real time showing conditions being encountered by the plow (Figure 3).

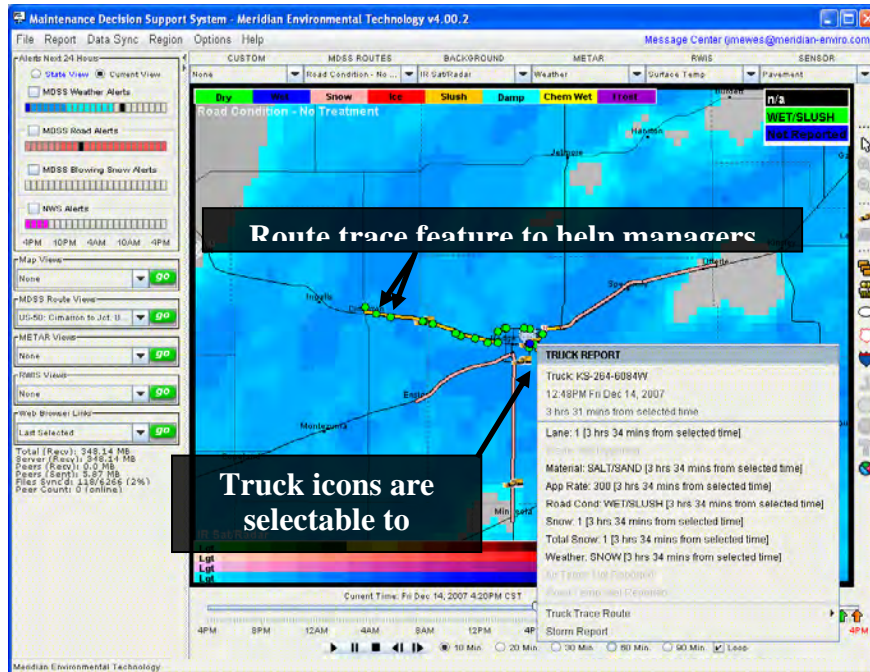

FIGURE 2 Snowplow locations and reported activities and conditions are displayed and selectable on the PFS MDSS GUI's map view, helping managers better track fleet operations.

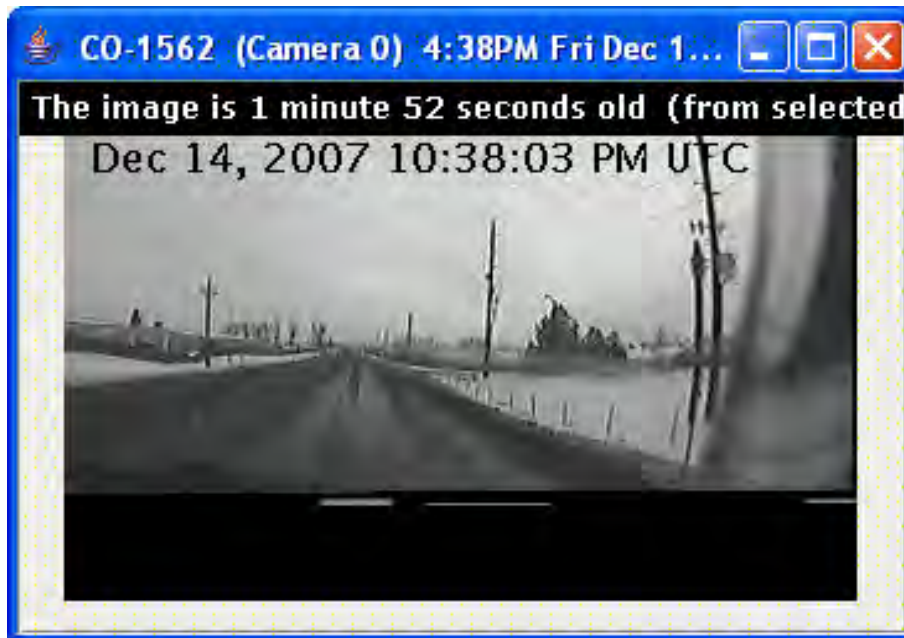

FIGURE 3 Dashboard camera images collected and communicated back through the Colorado DOT's MDC-AVL system are made available for both real-time and 24-h access via the PFS MDSS GUI. These images can help managers better understand the conditions being encountered in the field.

PROVISION OF MDSS INFORMATION THROUGH MDC–AVL SYSTEMS

A significant limitation to utilization of MDSS in many PFS member agencies was identified to be the lack of a centralized management structure for making tactical winter maintenance decisions. In these agencies the appropriate response is typically left at the discretion of the plow operator. Once a storm starts, the operators may be out of the maintenance garage for several hours at a time, and have limited time available for consulting with the MDSS GUI for guidance as to how to approach the storm going forward. Because of this, getting real-time MDSS information back into the operators’ hands was viewed as being as important as getting information from the operators back into MDSS.

Early in the project the only viable means of accomplishing this was to put short messages on the computer telephony system designed to support MDSS data collection. However, the adoption of MDC–AVL technologies has more recently opened the door to a much broader range of two-way information provision. The presence of a touch screen computer associated with the MDC–AVL systems supports both a menu-based system for reporting human-observable information such as road conditions to MDSS as well as a mechanism for visual display of important information back to the operator.

Information identified as candidates for initial provision into the trucks included MDSS recommendations, a short-term weather forecast, weather radar, and a real-time indication of where other vehicles were operating in the same vicinity. Figure 4 is an example of the in-vehicle MDSS (or VMDSS) format for provision of information back into the maintenance vehicle via the vehicle’s MDC–AVL system.

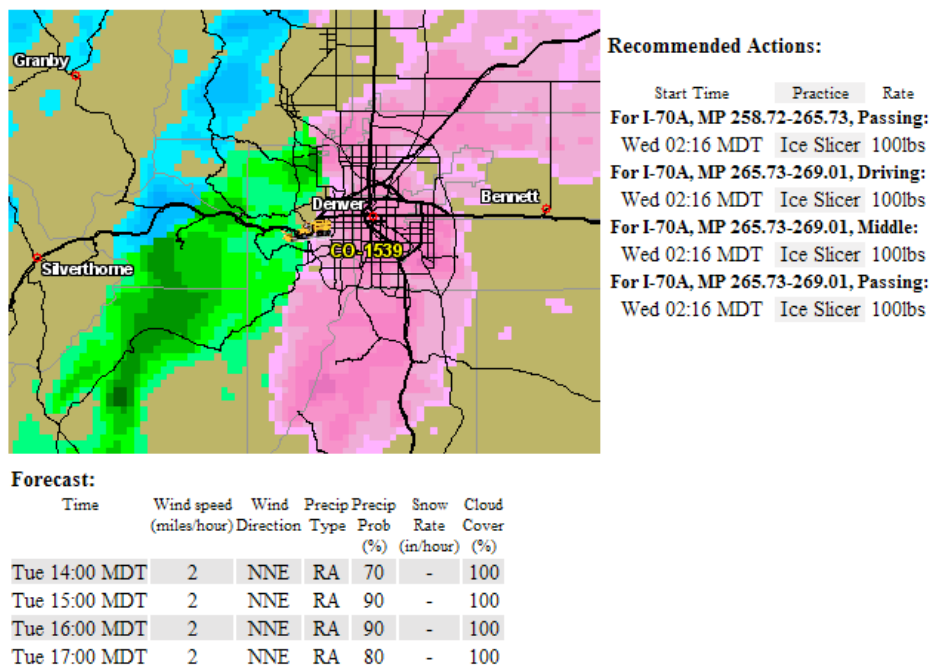

FIGURE 4 An example of the information presently being provided back into the snowplows of various PFS MDSS member agencies via MDC–AVL systems. The content is tailored specifically to the requesting truck and is provided in standard HTML format so as to promote standardization of content and format across different MDC–AVL systems.

Since there were multiple competing MDC–AVL vendors working in the various PFS MDSS member agencies, a major obstacle to VMDSS was provision of this information in a manner that was vendor-independent. The most viable way of establishing this vendor independence was to serve the information by means of HTML, the primary language used for the exchange of information on the Internet. Since each agency desired slightly different information and display formats, and since each MDC–AVL system possessed slightly different characteristics (e.g., screen size), a series of arguments controlling the layout and content of the VMDSS web page(s) were made optional in the VMDSS Uniform Resource Locator (URL). These options control such things as image sizes, radar zoom levels, number of hours of forecast information shown, fonts, color schemes, and general page organization. The specification of these configurations via the URL puts the customization capability in the hands of the agency and its MDC–AVL provider(s), thereby leaving a vendor- and agency-independent VMDSS infrastructure in place on the MDSS server.

OBSTACLES TO SUCCESSFUL UTILIZATION

While MDC–AVL technology holds considerable promise for supporting various information applications such as MDSS, the relative immaturity of MDC–AVL technologies in general means that many obstacles to successful implementation still exist.

From a hardware perspective, the snowplow environment is harsh and can take a toll on MDC–AVL hardware. Agencies are typically faced with a decision of purchasing equipment designed for heavy industrial application (at a premium price) versus buying commodity hardware that is likely to have a shorter lifespan. Regardless of the decision made, hardware does inevitably fail from time to time. Developing the tools and the expertise to diagnose and resolve problems with the MDC–AVL system must be part of each agency's MDC–AVL deployment plan.

Most agencies are also faced with decisions as to what data elements should be recorded automatically by the MDC–AVL system versus entered manually by the driver, typically via a touchscreen interface within the snowplow. In recognition of the safety issues involved most agencies are inclined to automatically record as much information as possible. This typically involves interfacing with the snowplow's spreader controller and installing plow position sensors that can monitor the position of plow blades installed on the truck. While most spreader controllers manufactured today have some capability for providing information about spreader activities to an external device, the format of this interface and the data elements that are available vary widely from one manufacturer to the next. This makes the process of tapping into the spreader controllers a difficult proposition for agencies that utilize equipment from numerous manufacturers. Further, many older spreader controllers incapable of communicating activities to an external device are still active in agency fleets, making the prospect of fleetwide automation presently impractical in many places.

There are as many obstacles from a human factors perspective. Many operators find it difficult to remember to keep the screen updated. The importance of this factor varies depending upon whether maintenance information is being automatically recorded and whether the snowplow is working a multilane highway. Defining a common dictionary for human-observed data elements is also problematic. Without training many operators end up reporting the same condition differently from what is intended. A third issue that is commonly faced is the "What's in it for me?" syndrome. If the MDC–AVL system is viewed as creating more work rather than as providing a useful tool to the operator the operators may be reluctant to support the system

with reliable data entry. This factor can be addressed by making the MDC–AVL system a platform for two-way communications to and from the vehicle, thereby providing information back to the operator that can serve as an incentive for keeping the system updated.

There are also a plethora of obstacles to successful data interpretation. A significant obstacle is the lack of standards in the industry. Standards would be beneficial to removing deployment obstacles at many levels. The lack of standards in interface formats and data elements at the spreader controller level has already been discussed above. However, the industry would also benefit substantially from vendor-independent standards for external data communication. The industry is presently in a similar position to where the RWIS industry was a few decades ago, where significant effort is required to interface with each new MDC–AVL data provider. Fortunately, the opportunity exists to change this paradigm before non-standard systems become widely entrenched. Several efforts to develop MDC–AVL standards adequate for supporting MDSS needs have been initiated by PFS MDSS agencies. These efforts include the development of a special National Transportation Communication for Intelligent Transportation Systems Protocol (NTCIP) node for the communication of MDC–AVL data from the South Dakota Department of Transportation’s MDC–AVL system as well as efforts to facilitate the addition of several new data elements to the official NTCIP 1204 standard that might permit more widespread adoption of this specification.

Also with regard to data interpretation, most maintenance personnel think in terms of maintenance actions or “runs.” Provision of MDC–AVL data in its raw GPS-based format typically doesn’t fit well with agency mindsets or record keeping systems. As such it is usually desirable to have an intermediary application interpreting and “upscaling” the GPS-based MDC–AVL data into more cohesive units of maintenance. This process, which was discussed previously, has been found by PFS MDSS researchers to be far more difficult than it may seem on the surface. The process is complicated by situations where multiple trucks simultaneously maintain a single route, conflicting conditions are reported from these trucks, portions of a single route receive much heavier maintenance than others, trucks pass onto and off of agency routes in the MDSS system, and routes are too short relative to the reporting interval of the MDC–AVL system for the truck’s activities on that route to be resolved.

Finally, potential obstacles also exist in the provision of information back into agency vehicles via the MDC–AVL systems. One obstacle is cost, as provision of data back into the trucks may require a data communications plan with higher or unlimited byte transmission allowances. Another complicating factor is the fact that the information provided to each vehicle must be automatically tailored to the vehicle. It is neither practical nor safe to require snowplow operators to wade through numerous selection interfaces to get at the desired data. The server must be able to identify the requesting vehicle and anticipate what information is likely to be of most interest to its operator.

CONCLUSIONS

MDC–AVL and MDSS systems are mutually enabling technologies that, while holding promise in their own right, may be much more valuable to an agency when deployed in tandem. In order to maximize the probability for successful deployments, agencies interested in these technologies should give careful consideration to the issues experienced by the PFS MDSS agencies so as to benefit from their collective experiences. Lack of forethought and planning to address these issues can prove costly and lead to a cascading set of problems that could eventually doom the MDC–AVL system.

REFERENCES

- Mewes, J. J., R. Hart, L. F. Osborne, and B. Podoll. *The Pooled Fund Study Maintenance Decision Support System: A Functional Overview*. Preprints, American Meteorological Society 21st International Conference on Interactive Information Processing Systems for Meteorology, Oceanography, and Hydrology, San Diego, Calif., 2005.
- Pisano, P. A., A. D. Stern, and W. P. Mahoney. *The U.S. Federal Highway Administration Winter Road Maintenance Decision Support System (MDSS) Project: Overview and Results*. Preprints, American Meteorological Society 21st International Conference on Interactive Information Processing Systems for Meteorology, Oceanography, and Hydrology, San Diego, Calif., 2005.

Relationships Between Weather Events and Traffic Operations

RELATIONSHIPS BETWEEN WEATHER EVENTS AND TRAFFIC OPERATIONS

Toward Weather-Responsive Traffic Management on French Motorways

NOUR-EDDIN EL FAOUZI

OLIVIER DE MOUZON

ROMAIN BILLOT

Transport and Traffic Engineering Laboratory, INRETS

It is well recognized that inclement weather conditions can severely affect mobility and safety. According to FHWA, adverse weather is the second largest cause of nonrecurrent congestion. Thus, rain can increase travel time delay by 12% to 20%. Nevertheless, there is no real implementation of weather-responsive traffic management tools except for winter operations and maintenance systems. Indeed, road managers and operators continue to apply traffic management strategies that are still not sensitive to weather conditions. At the same time, advances in sensor technologies enabling real time monitoring of roadway and environmental conditions offer ways to create better decision-support tools for road managers. Although much is known about weather effects on traffic, little has been achieved to date. This work aims at contributing to design and developing weather-responsive traffic management strategies for urban and interurban motorways.

Inclement weather conditions can affect traffic operations in terms of mobility and safety. According to FHWA, adverse weather is the second largest cause of nonrecurrent congestion (1). Weather conditions (snow, ice, and fog) cause 15% of nonrecurring congestion and rain increases travel time or delay by 12% to 20%. Weather can also impact safety by increasing crash frequency and crash severity (8). Thus, the analysis of the weather impacts appears as a critical issue for all road operators. At the same time, advances in sensor technologies enabling real time monitoring of roadway and environmental conditions offer ways to create better decision support tools for road managers. A better understanding of adverse weather conditions effects on traffic can bring many benefits:

First, this knowledge is necessary for answering the primary concerns of traffic management and control, which consists in bringing the most satisfactory response to the need of mobility and in anticipating the effects of inclement weather conditions on the traffic.

Second, the communication of real-time traffic and road weather conditions (precipitations, wind, visibility, etc.) to the traveler can lead to a better anticipation of the road risk and contribute to the improvement of the road safety.

Finally, it should also produce positive environmental benefits (in terms of reduced energy expenditure and emissions resulting from more efficient traffic flow management) and better informed trip decisions via efficient road situation monitoring.

The state of the art related to weather impact studies on traffic is relatively sparse and a first attempt was due to Jones et al. (2), who proposed one of the first studies about the environmental influence of rain on freeway capacity in 1970. The authors concluded that the capacity of the freeway during rain could be expected to be between 81% and 86% of the dry weather capacity. Later, Hall and Barrow (3) continued the study of the relationship between

flow and occupancy on freeways with uncongested data. They clearly showed that adverse weather affects freeway traffic by reducing the slope of the free flow speed. Similar approaches (4) have also demonstrated an impact of heavy rain on the flow–speed relationship. From these studies, a few works have confirmed the trend of a reduction of capacity and speed during inclement weather. Hence, the speed reduction during adverse weather increases the travel time, and standard traffic management tools should be adapted to be weather-responsive. For example, Al-Kaisy and Freedman (5) have proposed a strategy to modify the signal timings according to the weather conditions. Other approaches tackle the subject by focusing on the consequences of the effects of inclement weather. First, Chung et al. (6) have observed that inclement weather impacts the severity of traffic accidents. Second, inclement weather can modify traffic demand. For instance, Maze et al. (7) summarized the effects of snow on traffic volume.

In this paper, we aim to contribute to design and develop weather-responsive traffic management strategies for urban and interurban motorways (8). More precisely, this is the first step of a systematic approach for building weather-responsive traffic tools. Indeed, in spite of the increase of the interest concerning this theme, comprehensive assessment and modeling studies of weather impacts on traffic and safety are in general still sparse or not completed, although they may find important applications in practice.

This paper is structured as follows: first, a general methodology for integrating weather effects and modeling is described. Second, a first empirical study of French data is proposed. This study introduces an assessment of the impacts of inclement weather on traffic of interurban French motorways.

WEATHER EFFECTS INTEGRATION AND MODELING

In order to build successful tools that incorporate weather effects, the two following steps have to be carried out:

1. Analysis and quantification of weather impact. This task consists in analyzing the weather impacts on traffic. Therefore, it needs both traffic and weather data to study the interaction of weather and traffic operations. The main concern here is to provide not only qualitative but also quantitative weather effects on the main characteristics of traffic flow (volume, speed, capacity, density, headways, etc.).

2. Modeling and integration of weather effects into the modeling tools (simulation models) and traffic operations decision support tools currently used by traffic management centers.

These two steps are mainly carried out offline in order to assess and integrate the effects of adverse weather conditions on the main traffic variables. The results of these studies pave the way for developing weather-responsive traffic decision-support tools and online traffic management strategies. [Figure 1](#) describes this global modeling and integration strategy.

As shown in the first step of [Figure 1](#), the traffic flow can be described at three different levels:

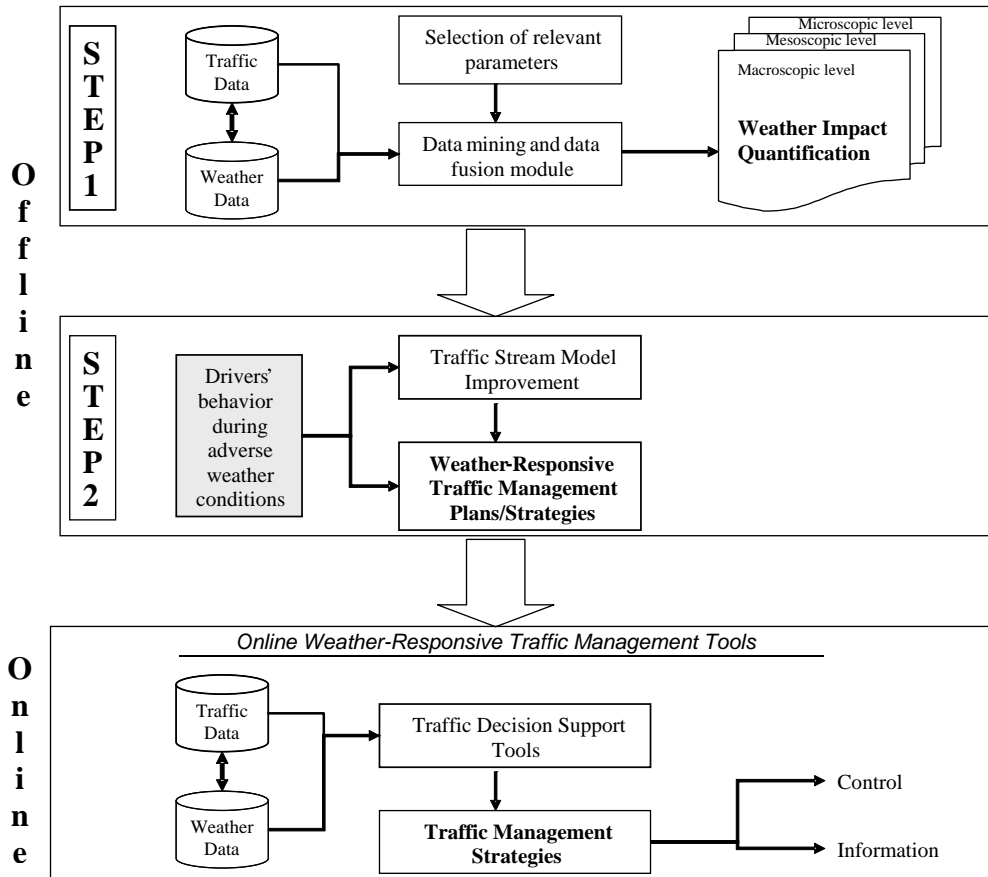

FIGURE 1 Overview of a weather-responsive strategy.

1. Microscopic level. This level is of paramount importance to assess the effect of weather on risk and traffic safety. The vehicles are considered individually with their speeds, positions and accelerations. The interactions between vehicles are observed with headways and distances between vehicles. During inclement weather conditions, it can be expected that headways may increase because of slippery roads, bad visibility, and bad vehicle performances. There is also a trend to increase distances between vehicles in order to ensure a better safety. It is also necessary to differentiate at each time the type of lane (left lane, median lane, and right lane), the type of vehicle and whether the traffic is congested or not.

2. Mesoscopic level. At this level, weather impacts may be inspected at platoon structure and composition. Again, the purpose is to assess precisely the changes under inclement weather conditions in terms of platoon speed, headway distribution in the platoon, temporal and spatial variation of the platoon composition.

3. Macroscopic level. This level considers a macroscopic modeling of the traffic. First, one idea is to quantify how the weather conditions may impact the capacity, density, speed, and, more important, the relationship between speed, density, and flow, known as the fundamental diagram.

The two “offline” steps must lead to the development of new traffic decision tools integrating the weather effects. Moreover, an “online” weather-responsive traffic management (Figure 1) must be developed through traffic indicators. In particular, to date, in France, travel-time indicators displayed through dynamic message signs do not adapt to the meteorological changes. Travel-time indicators must be proposed in order to integrate the effects of meteorology. This online weather-responsive traffic management should also consider modifying existing indicators with the intention of integrating weather parameters. Other indicators could be proposed as well such as safety or performance indicators.

In this respect, the crucial issue is how to integrate the effects of the weather at the macroscopic level through the fundamental diagram. The idea here is to achieve an original parameterization of the flow–density relationship according to the prevailing weather conditions. Two main, but equivalent, relationships are commonly used for describing the traffic flow: the flow–density relationship and the flow–speed relationship. The state of the practice offers different models for adjusting those relationships. In this respect, the first model was proposed by Greenshield, who assumed a linear speed–density relationship (9). This model is still nowadays much used because of its simplicity of calibration. Other models such as Greenberg (logarithmic) or Underwood (exponential) present some variants.

The fundamental diagram offers a convenient tool to incorporate weather effects at the macroscopic level and more generally in traffic stream models. Indeed, weather conditions affect flow–density relationship and the changes in this relation may capture the weather effects. This task serves the purpose of the second step outlined in Figure 1. After a parameterization of the fundamental diagram and therefore an improvement of the traffic streams model, other parameters come into play. Thus, the driver’s behavior facing meteorological changes must be considered as a single field of research.

EMPIRICAL STUDY ON FRENCH MOTORWAYS

Empirical assessment of weather effects on traffic relies on a comprehensive database with simultaneous traffic and weather data. To achieve this goal, the Transport and Traffic Engineering Laboratory is archiving motorway traffic data with weather information from a roadway weather information system (RWIS) or from the national meteorological agency (MeteoFrance).

For this study, the data used were collected on two different interurban motorways. Europe’s second-largest and France’s leading motorway network ASF (Autoroutes du Sud de la France) operates a network of 2,562 km located in the south of France. The second motorway is the Europe’s fourth-largest motorway network, APRR (Autoroutes Paris–Rhin–Rhône), responsible for a 2,279-km network located in the north part of France.

Microscopic Analysis

ASF’s Microscopic Data

The data were collected on the A9 Motorway (2*3 lanes) between Orange and Montpellier cities in the south of France. The particularity of the road sensors is that they provided individual data. With each passage of a vehicle, the sensors provide the following pieces of information:

- Date, hour, minute, second of the passage of the vehicle;
- Number of axles and length;
- Type of lane (slow lane, median lane, or rapid lane);
- Vehicle category;
- Time headways;
- Intervehicle distances; and
- Speed.

The weather data were obtained every 4 to 7 min from a RWIS close to the road sensor (less than 200 m). The most relevant data captured by the weather sensors are

- Localization,
- Date and hour,
- Air and road surface temperature,
- Wind speed, and
- Nature of precipitation (dry, light rain, medium rain, heavy rain).

Some of the raw data were preprocessed mainly by breaking continuous measurements into intervals. For example, we classify the air temperature measurements into three categories:

- Low temperature if air temperature $< 10^{\circ}\text{C}$ (50°F),
- Medium temperature if 10°C (50°F) $<$ air temperature $< 30^{\circ}\text{C}$ (86°F), and
- High temperature if air temperature $> 30^{\circ}\text{C}$ (86°F).

The same process applied to the road surface temperature and wind speed.

For this study, both weather and traffic data were collected during two consecutive weekends of year 2006 (January 6 through 7 and January 14 through 15). The particularity is that it had rained during the first weekend whereas the second weekend was dry. The intensity of rain was medium. This situation is ideal for comparing the microscopic variables on condition of selecting two similar periods with a comparable number of vehicles. Only the variable “weather” must change. This selection was done and the comparison was carried out on the basis of the data of two successive Saturdays at the same periods, with identical conditions, as shown in [Table 1](#).

TABLE 1 Traffic State for the Two Periods of Comparison

Date and Time	Weather Conditions	Slow Lane		Median Lane		Fast Lane		Total No. of Vehicles	Traffic State
		No. of Vehicles	Cars (%)	No. of Vehicles	Cars (%)	No. of Vehicles	Cars (%)		
Saturday 1/7/2006, from 1:53 to 3:12 p.m.	Rainy	1,525	63	1,851	99	512	100	3,888	Uncongested for all lanes
Saturday 1/14/2006, from 1:53 to 3:12 p.m.	Dry	1,571	56	1,821	97	482	100	3,874	Uncongested for all lanes

Regarding the weather conditions, the other potential factors that could impact the results (e.g., wind and temperatures) were kept constant (see below). So, on the one hand, it rained from 1:53 to 3:12 p.m. on January 7, 2006. And on the other hand, the weather was dry the next Saturday during the same period. Besides, the weather sensors showed that the other weather parameters were identical for both days: light wind (<16 km/h, 9.94 mph), low temperature (<10°C, 50°F). Moreover, there was no risk of icy roads since the roadway temperature was greater than 0°C (32°F).

This prestudy led to the selection of an appropriate subsample in order to minimize the potential impacts of the inherent variability of traffic data. This enables a more precise comparison of two similar profiles of traffic situation, just differentiated by the weather conditions.

Vehicle Distribution over the Three Lanes

To start with a microscopic observation of the effects of adverse weather conditions on traffic, it could be relevant to compare the distribution of the vehicles over the three lanes under dry weather conditions and rainy weather conditions. It is also necessary to differentiate at each time the type of vehicle: car or heavy good vehicle (HGV). [Figure 2](#) summarizes the results concerning car and HGV distributions.

In [Figure 2](#), we observe that medium intensity of rain has almost no effect on the car distribution. We could expect another behavior for the HGV distribution. Indeed, even a medium rain should increase the number of HGVs on the slow lane in comparison with dry conditions. This intuition is confirmed by the left part of [Figure 2](#), which summarizes the same results concerning the HGVs.

Regarding HGVs, medium rain has an impact on lane selection. First, due to the traffic regulation of HGVs in France, the percentage of HGVs is almost zero on the fast lane because of an interdiction of driving on this lane. For the two other lanes, a significant proportion of HGVs (4.2%) driving on the medium lane during dry weather conditions transferred onto the slow lane under adverse weather conditions. This fact is rather logical: HGVs are more sensitive to a slippery road and HGV drivers (more experienced than the majority of drivers) are aware of their driving performances and necessary adjustments to the weather conditions.

Time Headway and Spacing Distributions

It can be expected that the headway (H) and the spacing (S) distributions change during wet conditions. First, the study about our data subset has underlined an impact on the short time headways and small spacing. [Figure 3](#) illustrates this trend on the fast lane.

In [Figure 3](#), the headways are observed according to the frequency of the different H categories. Regarding the fast lane, we observe a drop of 6% of the $H < 2$ s under rainy conditions. Another decrease is observed for $H < 4$ s. In parallel, this drop is reported on a rise of the headway between 4 and 6 s. This fact is correlated with an increase of the spacing, as shown in [Figure 4](#).

[Figure 4](#) confirms the trend: there is a significant decrease of the frequency of short spacing under rainy conditions. In general, a fall of more than 6% of the $S < 50$ m (54.6 yd) was noted. This trend hardly comes as a surprise. Without extrapolating, we can infer that drivers feel less secure under adverse weather conditions, so they reduce the S and de facto increase

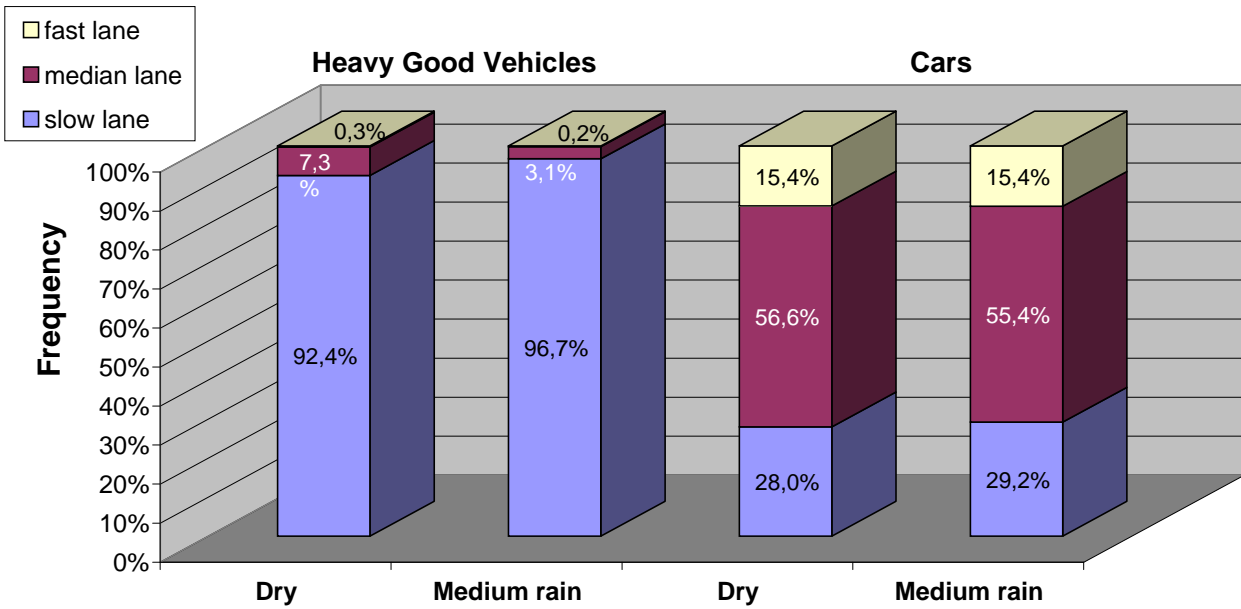

FIGURE 2 Vehicle distribution over the three lanes.

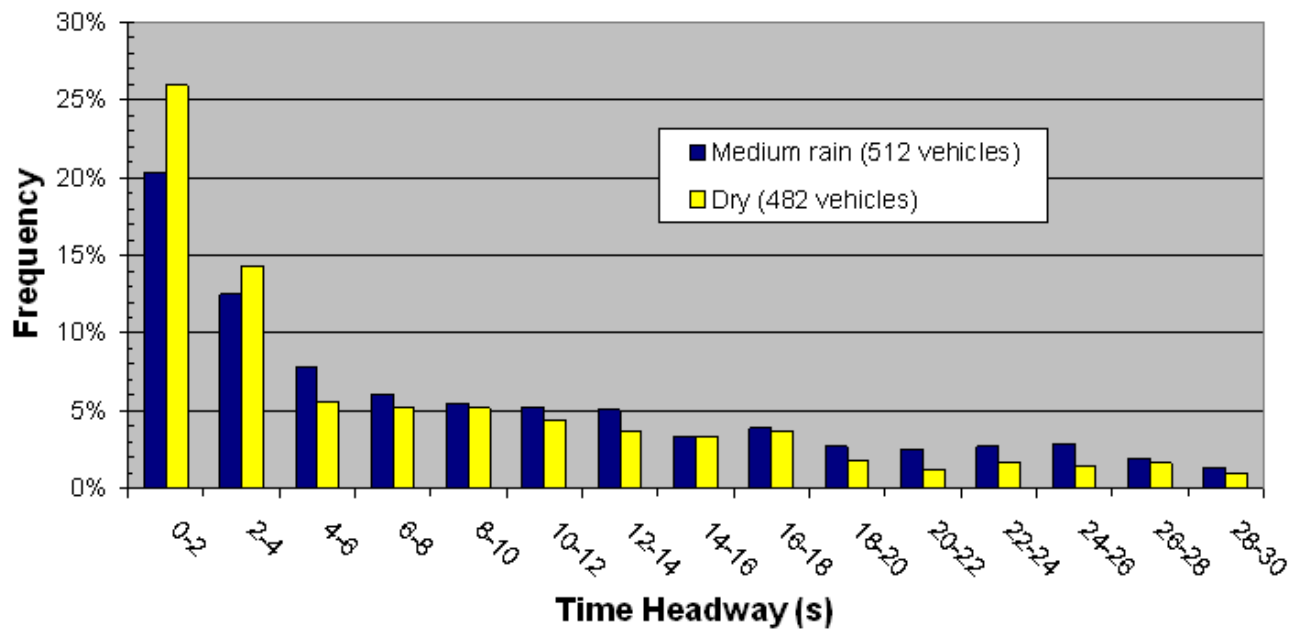

FIGURE 3 Frequencies of different headway categories on the fast lane.

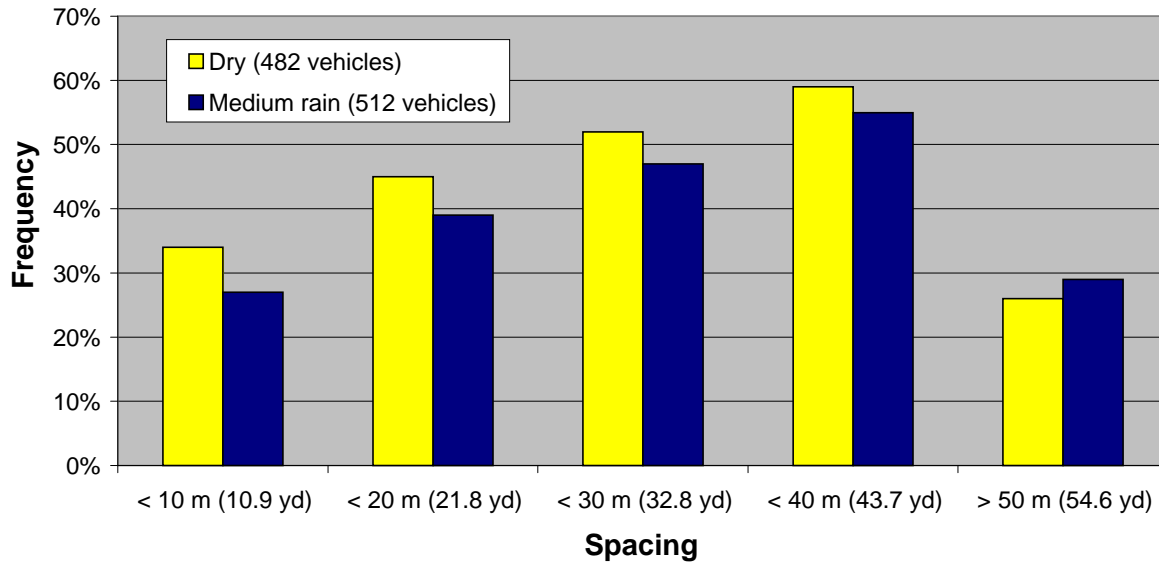

FIGURE 4 Frequencies of different spacing categories on the fast lane.

headways. As far as the three lanes are concerned, an average increase of 4% is noticed for the time headways greater than 2 s. At the same time, an average increase of 4% is observed for the spacing longer than 50 m (54.6 yd).

Speed Distributions

It is widely accepted that inclement weather can impact the traffic by reducing speeds. However, according to the intensity of rain or the type of lane, the speed decrease can be more or less significant. Observing the speed distributions at a microscopic level can confirm this idea. Hence, the speed distributions on the slow lane have been compared. [Figure 5](#) summarizes the speed distributions for the passenger cars only.

It is restated here that the legal speed limit on French motorways is 130 km/h (81 mph) under dry conditions and 110 km/h (68 mph) under adverse weather conditions. Regarding passenger car speeds, the frequencies of speeds under 120 km/h (75 mph) are higher under adverse weather conditions. Indeed, the frequencies move from 55% to 62%. These results show that car drivers reduce in majority their speed under rainy weather conditions.

Conclusion

To conclude this part devoted to the microscopic study, we can say that rain impacts drivers' behavior by reducing the speed and increasing time headways and spacing. The car drivers reduce their speed too and an average increase of 4% is noticed for the time headways greater than 2 s and for the spacing greater than 50 m (54.6 yd).

A data subset was selected in order to make an efficient comparison. Nevertheless, such a pretreatment of data requires a more comprehensive database. In particular, there is a need to lead microscopic studies under various rainy conditions, according to the intensity of rain.

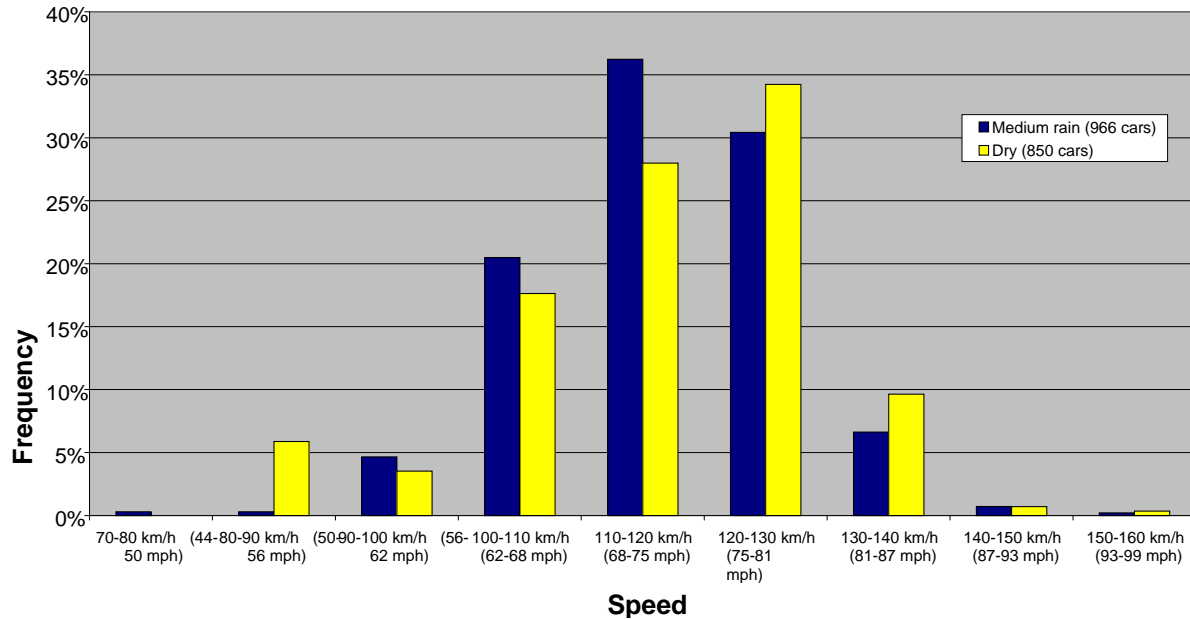

FIGURE 5 Frequencies of different speed categories for cars on the slow lane.

Furthermore, it could be relevant to study the HGV drivers' behavior independently and assess their sensitivity under the influence of the rain.

Macroscopic Analysis

APRR Data Description

For this macroscopic analysis, data from the French Motorway Company APRR have been used. The data were recorded between April 15, 2005, and April 28, 2005, on the A6 Motorway (2*3 lanes, Paris toward Lyon). Contrary to ASF data, these data were not recorded individually but are based on aggregations on 6-min intervals. Traffic and weather sensors provide these measurements every 6-min:

- Free-flow speed (km/h),
- Flow (vph),
- Occupancy (%), and
- State of the road surface (according to the humidity measured on the pavement).

The particularity of the weather data comes from the information about the state of the road surface. In accordance with the previous study, it was necessary to map road surface condition in the prevailing weather conditions (light rain, medium rain, and heavy rain). This mapping was performed using training samples providing both road surface information and weather information based on a similar sensor technology. Therefore, a factorial correspondence analysis was carried out from a contingency table (10).

Relationship Between Flow and Density

First, the APPR data are not comprehensive enough to make an in-depth study both about cars and HGVs. This study will focus on the cars. Second, considering the collected periods, there is a lack of congested data and the study could therefore only be done for the uncongested situations. A preliminary examination of traffic composition underlines the fact that the proportion of passenger cars recorded during 6-min intervals could be very variable. For this reason, the study was separated according to the different classes of passenger car frequencies. More precisely, data were divided into four classes:

- 20% < percentage of cars < 40%,
- 40% < percentage of cars < 40%,
- 60% < percentage of cars < 80%, and
- 80% < percentage of cars < 100%.

Then, the scatterplot of the flow–density relationship was done for each class of traffic composition. Of course, these figures have only been done from uncongested data and the traffic-jam density could not be determined. Figure 6 shows a representation for the class for which the passenger cars represent more than 80% of all recorded vehicles.

Concerning the largest densities (> 25 veh/km, 40 vpm) Figure 6 shows a decrease of vehicle flow under rain. With regard to the three other classes, it's harder to confirm this trend because there are fewer collected data. In particular, there is a lack of data collected in rainy conditions.

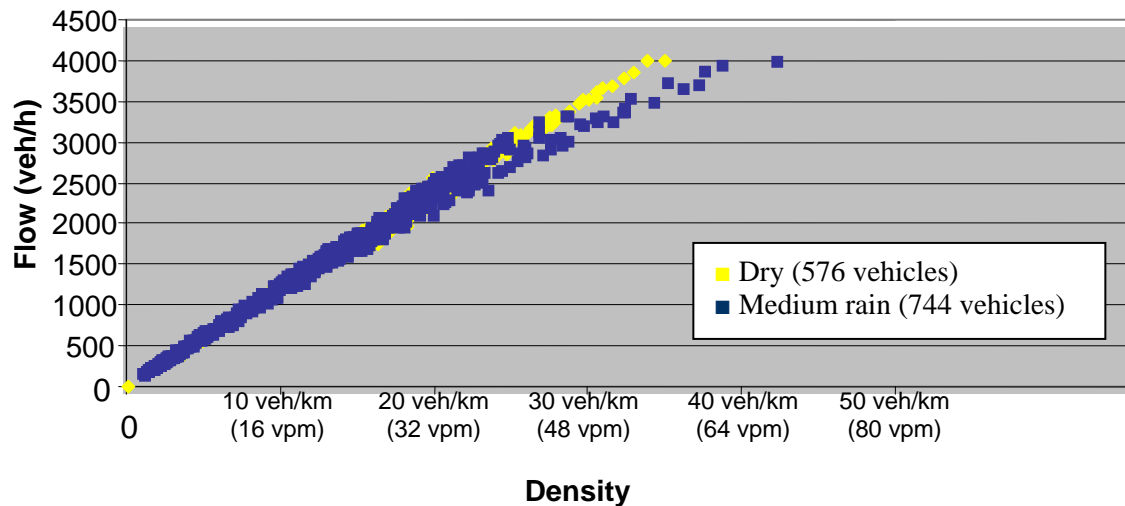

FIGURE 6 Flow–density relationship: 80% < percentage of cars < 100%.

Fundamental Diagram Calibration

The fundamental diagram offers a convenient tool to incorporate weather effects at the macroscopic level. For this study, the two-regime Pipes model has been used. The Pipes model (11) considers rather simple relations between speed, density, and flow, as shown in Figure 7.

Since the data only include uncongested data, the impact of adverse weather will be limited to free flow speed and its impact on capacity and traffic-jam density cannot be quantified. Nevertheless, it is possible to analyze the effects of medium rain on free-flow speed by calibrating a traffic model. From the previous results, the Pipes model was chosen (in fluid regime) in order to model the evolution of the free flow speed according to traffic composition. The results of the Pipes model's calibration are given in Table 2. The calibration was done for each class of traffic composition and the bounds of confidence intervals are reported in the table.

From Table 2, we conclude that free flow speed decreases for each traffic composition class under rainy conditions. This drop is significant regarding classes with more than 40% of cars: confidence intervals do not overlap each other. As far as the last class is concerned (20% < % cars < 40%), confidence intervals very slightly overlap. As a conclusion, the speed reduction is not significant for this case. This result may be due to the small number of data involved. To view the results of the table, the evolution of the free flow speed is represented in Figure 8, depending on traffic composition, together with the confidence intervals with 95% confidence level associated.

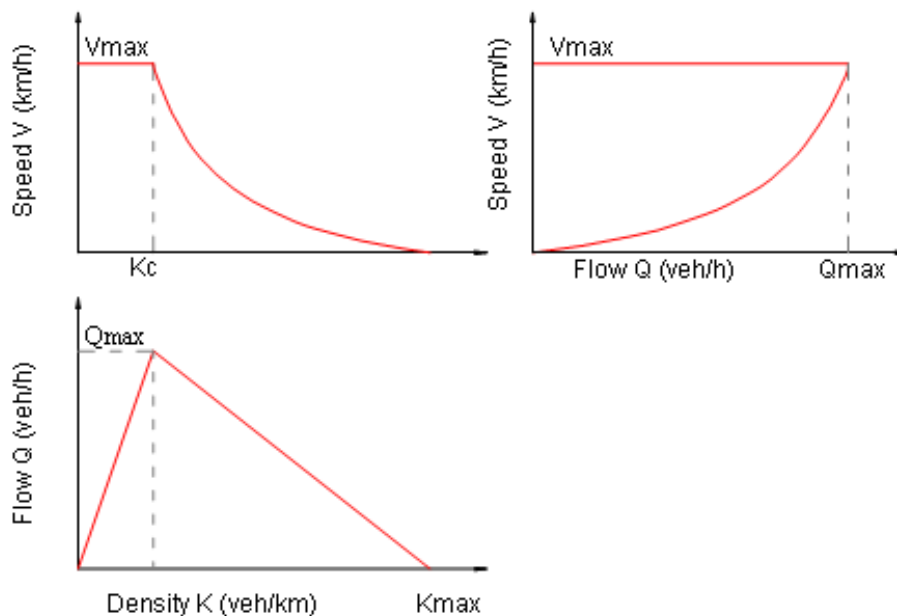

FIGURE 7 Fundamental diagram of Pipes model.

TABLE 2 Pipes Model Calibration

Class (% Cars)	Weather Condition	Sample Size	Free-Flow Speed (km/h)	Lower Bound of 95% Confidence Level	Upper Bound at 95% Confidence Level
80%–100%	Dry	576	118.5	118.3	118.8
	Medium rain	744	114.8	114.3	115.3
60%–80%	Dry	818	111.3	111.0	111.6
	Medium rain	322	109.9	109.5	110.2
40%–60%	Dry	271	104.3	104.0	104.6
	Medium rain	241	102.1	101.7	102.5
20%–40%	Dry	184	97.6	97.2	98.0
	Medium rain	146	96.9	96.5	97.3

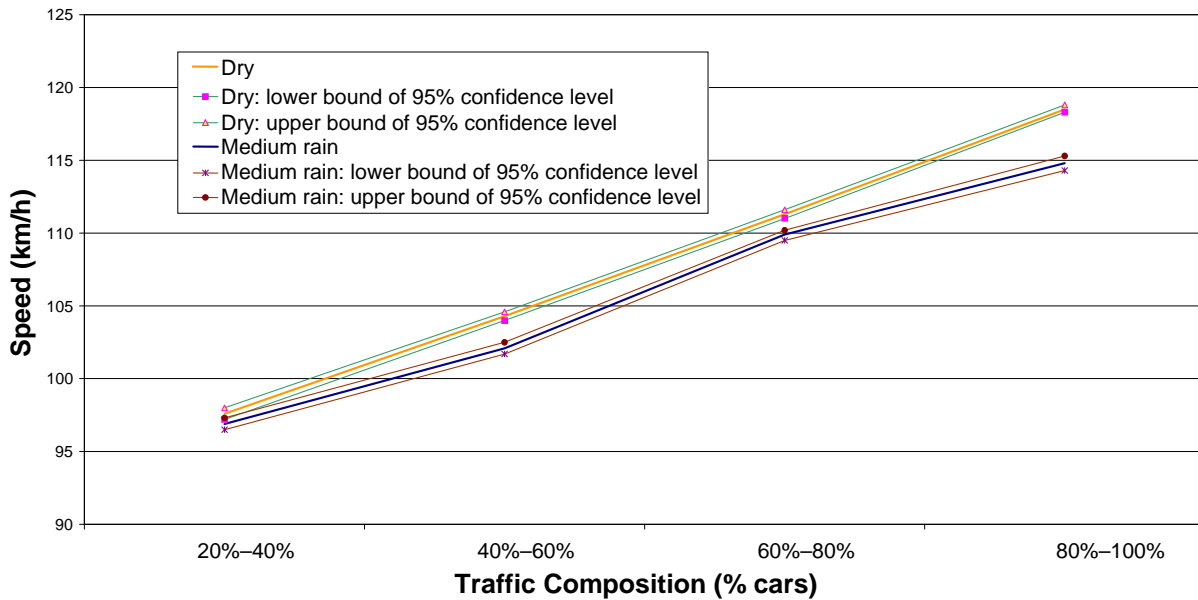

FIGURE 8 Free-flow speed % cars relationship with 95% confidence level.

According to the calibration of the Pipes model, Figure 8 shows the relationship between free-flow speed and the percentage of passenger cars conditionally to traffic composition. An average decrease of 2.1% of the free-flow speed is noted concerning the 40% to 60% interval, 1.2% reduction concerning the 60% to 80% interval, and 3.1% reduction concerning the 80% to 100% interval.

CONCLUSIONS AND ONGOING WORK

Microscopic and macroscopic studies have revealed some relevant results concerning the effects of inclement weather on traffic.

First, a microscopic study was managed from individual data of French motorways. The data analysis showed a definite influence of rainy conditions on individual traffic variables. This influence is reflected by a reduction of short time headways (e.g., 6% reduction on the fast lane concerning $H < 2$ s), a decrease of short intervehicular distances (–6% of $S < 50$ m on the fast lane), and more generally a significant speed reduction. These effects are more or less strong depending on whether the vehicles are in slow or fast lanes. On the one hand, the headway and spacing reductions are more significant on the faster lanes. On the other hand, the speed reduction is more significant on the slower lanes. This could be interpreted as different weather-related driver behaviors, one keeping on the slow lane with usual headways but a lower speed, another keeping speed on the fast lane but increasing headways.

Second, at the macroscopic level, the study was carried out on different traffic composition classes according to the percentage of passenger cars in the traffic composition. This enabled a calibration of a fundamental diagram (Pipes model) and proved a noticeable reduction of the free flow speed (e.g., 3.1% reduction if more than 80% of vehicles are passenger cars) under adverse conditions.

Nevertheless, this work remains incomplete due to lack of data. For instance, it is necessary to have both congested and uncongested data to make a more sensitive analysis. A larger period of study can also account for a greater variety of weather conditions and compare the differences according to the intensity of rain and snow.

A comprehensive database is one necessary condition for building a traffic model taking into account explicitly the effects of the meteorology on traffic. Through a parameterization of the fundamental diagram according to different weather conditions, such a model could open up the way to integrate these effects to traffic indicators. These tools can help the road managers to take the most informed decision possible. Parts of such a system are in development and for example Nevada set up a high wind warning system that prevents and protects drivers from extreme weather conditions [see Nelson et al. (12)]. This system leads to a restriction of heavy vehicles on some roads under high-wind conditions.

This topic is clearly an important issue for traffic management and needs to be further investigated (8). In this paper, the first results of a new research program were presented. This work is part of a global strategy described in this article, aiming at integrating weather effects in traffic decision support tools. A more comprehensive project was launched at the European level recently. Its main objective consists in bringing solutions to the road operators enabling the emergence of new traffic management strategies and paving the way for a real-time weather responsive management.

ACKNOWLEDGMENTS

The authors would like to thank the ASF and APRR French Motorway Companies for providing them with operational data used in this work.

REFERENCES

1. FHWA. *Road Weather Management Overview*. Available at <http://ops.fhwa.dot.gov/Weather/overview.htm>. Accessed November, 15, 2007.
2. Jones, E. R., M. E. Goolsby, and K. A. Brewer. The Environmental Influence of Rain on Freeway Capacity. In *Highway Research Record 321*, HRB, National Research Council, Washington, D.C., 1970, pp. 74–82.
3. Hall, F., and D. Barrow. The Effect of Weather on the Relationship Between Flow and Occupancy on Freeways. In *Transportation Research Record 1194*, TRB, National Research Council, Washington, D.C., 1988, pp. 55–63.
4. Ibrahim, A., and F. Hall. Effect of Adverse Weather Conditions on Speed-Flow-Occupancy Relationships. In *Transportation Research Record 1457*, TRB, National Research Council, Washington, D.C., 1994, pp. 184–191.
5. Al-Kaisy, A., and Z. Freedman. Weather-Responsive Signal Timing. In *Transportation Research Record: Journal of the Transportation Research Board, No. 1978*, Transportation Research Board of the National Academies, Washington, D.C., 2006, pp 49–60.
6. Chung E., O. Ohtani, H. Warita, M. Kuwahara, and H. Morita. Effect of Rain on Travel Demand and Traffic Accident. Presented at 8th International IEEE Conference on Intelligent Transportation Systems, 2005.
7. Maze, T. H., M. Agarwal, and G. Burchett. Whether Weather Matters to Traffic Demand, Traffic Safety, and Traffic Operations and Flow. In *Transportation Research Record: Journal of the Transportation Research Board, No. 1948*, Transportation Research Board of the National Academies, Washington, D.C., 2006, pp. 170–176.
8. El Faouzi, N.-E. Research Needs for Real Time Monitoring, Surveillance and Control of Road Networks Under Adverse Weather Conditions. Research Agenda for the European Cooperation in the Field of Scientific and Technical Research (COST), 2007.
9. Greenshield, B. D. A Study of Highway Capacity. In *Highway Research Board Proceedings*, Vol. 14, HRB, National Research Council, Washington, D.C., 1934.
10. Khomsi, O. Weather Impacts Analysis on Intra and Inter-Urban Motorways' Traffic. Ms thesis, INRETS-ENTPE, 2006 (in French).
11. Pipes, L. A. Car Following Models and Fundamental Diagram of Road Traffic. *Transportation Research*, Vol. 1, 1967.
12. Nelson, R. Weather-Based Traffic Management Applications in Nevada. Presented at Institute of Transportation Engineers (ITE) Annual Meeting, August 2002.

RELATIONSHIPS BETWEEN WEATHER EVENTS AND TRAFFIC OPERATIONS

Long-Term Analysis of Reductions in Traffic Volume Across New Hampshire During Winter Storms

MELISSA GRACE WELLMAN
Hometown Forecast Services

SAMUEL MILLER
Plymouth State University

STEPHEN GRAY
New Hampshire Department of Transportation

JOSEPH ZABRANSKY
Plymouth State University, retired

Snow, sleet, freezing rain, and rain are all common occurrences throughout the northeastern United States. These hazardous weather conditions can paralyze communities statewide. Reductions in traffic volume during these hazardous events can be used to quantify the number of people affected by a particular winter storm and provide a measure of how people perceive the severity of individual winter storms. Traffic counts were provided by the New Hampshire Department of Transportation for 15 locations across the state. These counts were then correlated with nearby weather observations, provided by the National Climatic Data Center and Plymouth State University's online database. There were 51 storm events between November 1999 and March 2004. The reductions in traffic volume were calculated hourly and by day and compared with individual storm characteristics. The hourly reductions were compared to temperature, dewpoint, relative humidity, wind speed, wind direction, wind gusts, pressure, sky cover, visibility, precipitation type, and precipitation intensity. In addition the daily reductions were compared to snowfall amounts. A statewide average hourly reduction in traffic volume of 22.2% was found for all winter storms. Reductions in traffic volume were found to be most related to storm characteristics related to storm intensity. Storm hours with a northeast wind component were more likely to have the greatest reductions in traffic volume. Likewise, the intensity of snowfall on average across the state doubled the reductions in traffic volume. Reductions in traffic volume also held a strong relationship with visibility: the lower the visibility the greater the reductions in traffic volume. Hourly reductions were also closely correlated to diurnal pattern. The greatest reductions in traffic volume occurred after the evening commute; however, the greatest reductions in vehicles occurred during the evening commute. The comparisons between storm total snowfall and average storm reduction in traffic volume proved to be the most significant relationships. Storm average reductions were found to be related to storm total snowfall. However, they are most related to locations with the greatest average daily traffic volume. In addition, a direct relationship was found between the statewide storm average reductions and the statewide storm total snowfall, and an even stronger relationship with statewide average snowfall amounts greater than 5 in.

New Hampshire has long been known for experiencing adverse winter weather, and every year drivers are forced to make the decision to drive or not to drive in snow, ice, and freezing rain. There has been a recent awakening in the weather and transportation community calling for

additional research on the effects of weather on roadways, in order to improve maintenance practices. This research integrated weather and traffic data over five winter seasons to evaluate the reductions in traffic volume across New Hampshire.

LITERATURE REVIEW

Hanbali and Kuemmel researched the effects of winter weather events on traffic volume across four states for several months (1). They calculated the reductions in traffic volume for ranges of snowfall, time of day, and day of the week (1). They reported that there was a direct relationship between the reduction in traffic volume and snowfall accumulation (1). They also found that increases in the reductions in traffic volume were noted during peak travel hours, but reductions were greatest in the off-peak travel times and on weekends (1). Hanbali and Kuemmel also analyzed the events based on total snowfall, average daily traffic, roadway type, time of day, and the duration of the storm. They found that reductions varied between 7% and 56% for all events (1).

Similar research was also completed by Knapp and Smithson in Iowa (2). They used Road Weather Information System (RWIS) data to determine winter weather events and compared hours of inclement weather with data from automated traffic counters (ATCs). They found relations between intensity and duration of snowfall and reductions in traffic volume (2). The average reduction in traffic volume was determined to be 29%; however they also reported that the averages were highly variable between each storm event (2).

Maze et al. found results suggesting that visibility and wind speeds also affect the reductions in traffic volume in rural Iowa (3). The results showed that on snowy days with good visibility and low wind speeds there was a 20% reduction in traffic volume (3). However, on snowy days with poor visibility and high wind, speed reductions were increased to 80% (3).

DATA COLLECTION AND METHODOLOGY

This research involved the careful integration of several different sources of weather and traffic information. Hourly traffic counts were provided by the New Hampshire Department of Transportation (NH DOT) (4). Hourly weather observations were collected from the Plymouth State University Judd Gregg Meteorological Institute online archive of meteograms and were integrated with the hourly traffic volumes (5). In addition the daily snowfall measurements were obtained from the National Climatic Data Center storm reports (6), and in addition snowfall measurements for one location were obtained from Cannon Mountain Ski Resort, Franconia, New Hampshire (7). These data were compiled with daily traffic volumes. These two data sets have been used to analyze the long-term relationships between winter storms and traffic volume across New Hampshire.

Data Locations

The locations of the weather, snowfall, and traffic data were selected based on their proximity to each other and represented similar topography. Also, an effort was made to incorporate all major roadways throughout the state and provide an equal representation of New Hampshire. Thirteen locations across New Hampshire were used for the hourly comparisons between weather observations and traffic volumes, and there were fourteen locations used for the daily comparisons of

snowfall amounts and daily traffic volume. The addition of one location for the daily comparison was because of an important stretch of highway with no corresponding weather observations in Lincoln, New Hampshire. The locations of the weather and traffic pairs are shown in Figure 1 and are identified with the town where traffic volume was reported. The locations of the traffic volume, weather observations, and snowfall measurements are listed in Table 1.

Storm Events

All storms resulting in precipitation between November through March between the years of 1999 and 2004 were used for this project. All major holidays were removed from the data sets to reduce biases from nonregular traffic patterns. The storm events were first established using the National Oceanic and Atmospheric Administration storm reports (8). These events were then verified using the Plymouth State University Judd Gregg Meteorological Institute's meteogram archive for the selected observing locations. An "event" was defined as a storm where precipitation was observed in more than one New Hampshire county for a period of time greater than four hours. The start times of the events were recorded by noting the hour when the meteogram weather type indicated precipitation in the form of rain, snow, sleet, or any combination of the three. At locations where records did not indicate precipitation type, an estimated time of onset was determined using a Great Circle distance weighting scheme and all surrounding observations. The same process was used to determine the ending time of each storm event.

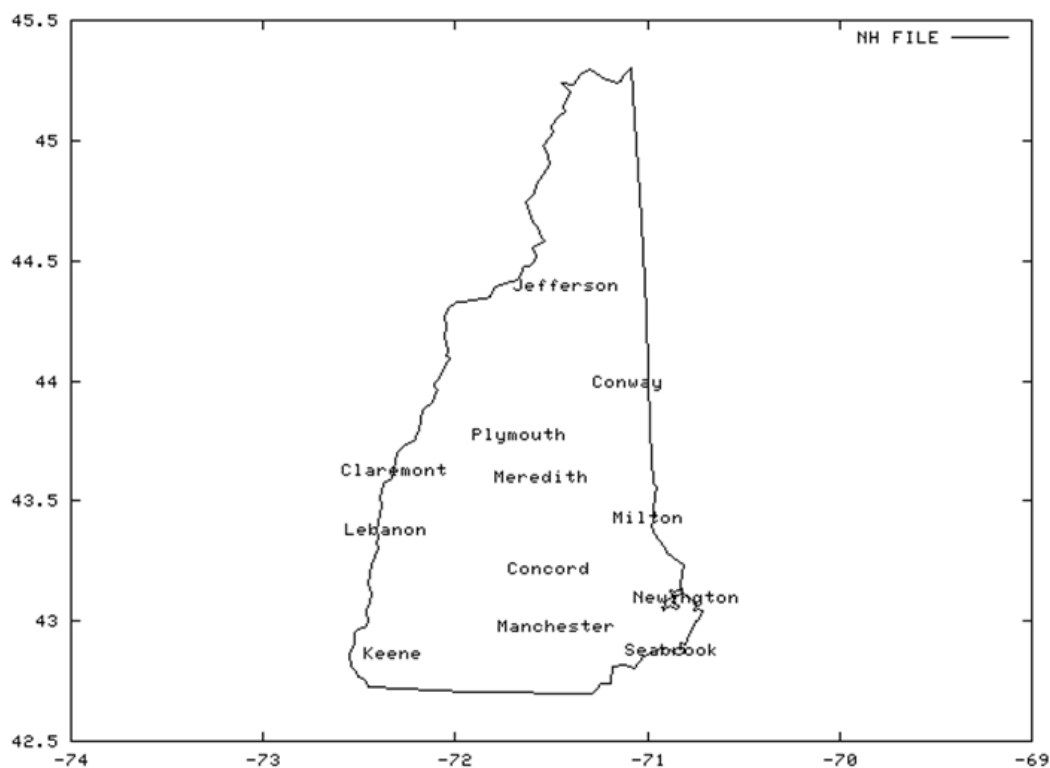

FIGURE 1 Traffic collection locations.

TABLE 1 Locations of the Traffic Volume, Weather Observations, and Snowfall Measurements

Traffic Location	Roadway	Weather Location	Snowfall Location
Jefferson		Littleton (KHIE)	Jefferson
Conway			
Lincoln			Cannon Mt.
Plymouth		Plymouth (KPLY)	Plymouth
Lebanon			
Claremont			
Meredith		Laconia (KLCI)	
Concord		Concord (KCON)	Concord
Milton		Rochester (KDAW)	
Manchester		Manchester	
Keene			
Newington		Portsmouth (KPSM)	Newburyport, MA
Seabrook		Portsmouth (KPSM)	

Hourly Weather Observations and Traffic Volume Data

The hourly weather observations include temperature, dewpoint temperature, relative humidity, wind speed, wind gusts, wind direction, pressure, visibility, ceiling height, and for some locations sky cover and precipitation type. This information was recorded with the corresponding hour's traffic volume and average traffic volume. The average hourly traffic volume was calculated for each hour of the day, for each weekday, and for each month of the research period for all nonstorm days. This ensured that any long-term changes in traffic volume were removed from the calculated average hourly traffic volume. This hourly average traffic volume was used to predict what the traffic volume would have been if there had been no adverse weather event. The percent reductions in traffic volume were then calculated using

$$\% R_{hr} = 100(1 - (T_{hr}/\bar{T}_{hr})) \quad (1)$$

where

$\%R_{hr}$ = percent reduction in traffic volume,
 T_{hr} = storm hour traffic volume, and
 \bar{T}_{hr} = nonstorm average hourly traffic volume.

The percent reductions in traffic volume were calculated for each storm hour at each location and recorded with the corresponding weather observations listed above.

Daily Snowfall Measurements and Traffic Volume Data

Daily snowfall measurements were collected from each of the snowfall locations listed in Table 1. Storm total snowfall measurements were then calculated for winter storms occurring on more than one calendar day by adding the daily snowfall totals. Again an average daily traffic volume

was calculated for all nonstorm days excluding major holidays. These were calculated for each weekday of all months through the 5-year period. Like the hourly averages these daily traffic volume averages were used to predict what the traffic volume would have been without the winter storm. The daily reductions in traffic volume were calculated using

$$\%R_d = 100(1 - (T_d / \bar{T}_d)) \quad (2)$$

where

$\%R_d$ = percent reduction in traffic volume,

T_d = storm day traffic volume, and

\bar{T}_d = nonstorm daily traffic volume.

The percent reductions in traffic volume were calculated for each storm day and then averaged for all storm days in a particular event. These then were recorded with the storm total snowfall. In addition the storm average reductions in traffic volume and the storm snowfall were each averaged across all locations, creating a statewide comparison.

ANALYSIS OF REDUCTIONS IN TRAFFIC VOLUME DUE TO WINTER STORMS

The analysis of the reductions in traffic volume compared to the weather and snowfall information was done through a series of linear comparisons. Average reductions in traffic volume were calculated for different circumstances. The results are discussed in the following sections.

Hourly Reductions in Traffic Volume and Weather Observations

The statewide average hourly reduction in traffic volume was 22.20% for all storm hours. Across the state the average hourly reductions in traffic volume varied between 29.59% and 11.53% as shown in [Figure 2](#), with most of the reductions falling between 20% and 25%.

There were large variations in the hourly reductions in traffic volume. At times traffic volume was decreased by nearly 100% but increases of as much as 200% were also found. Storms where vehicle volumes were increased were represented with positive reductions in traffic volume, but storms resulting in an increased traffic volume were represented with negative percentage. The distribution of the hourly reductions in traffic volume shown in [Figure 3](#) indicated a greater amount of positive reductions in traffic volume. This suggested that winter storms were more likely to cause a reduction rather than an increase in traffic volume. Increases in traffic shown as negative reductions between -200% and -60% were considered negligible and accounted for less than 0.6% of the total number of hours. Even though the distribution was skewed it was centered on reductions between 0% and 40% and showed the greatest frequency of hours between 10% and 20%. This indicated a slightly smaller average reduction than the statewide average of 22.20% discussed earlier.

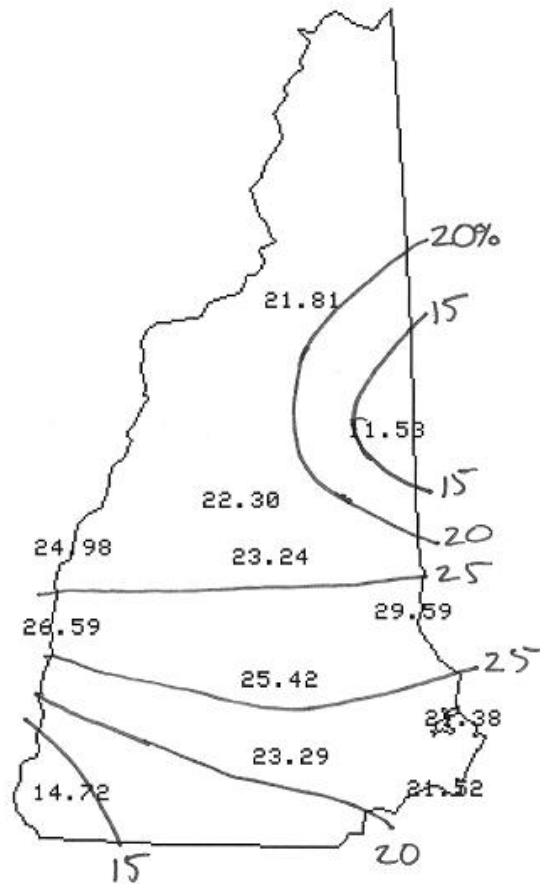

FIGURE 2 Contour analysis of the average hourly reductions in traffic across the state of New Hampshire.

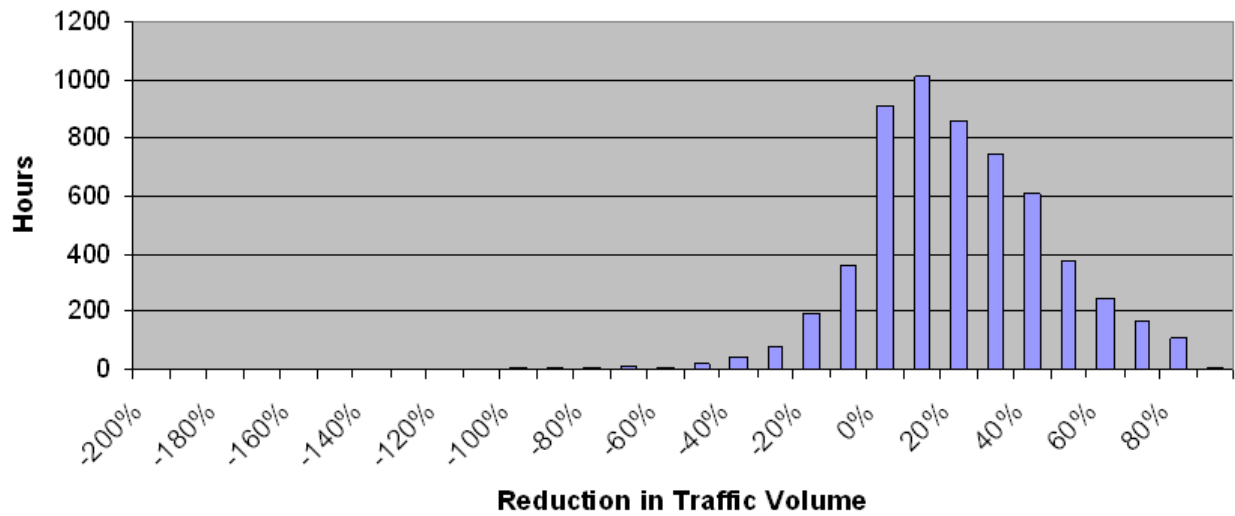

FIGURE 3 Histogram of the average hourly reductions in traffic volume.

The hourly reductions in traffic volume were first compared to nonstorm-related variables to understand any underlying biases in the reductions. The nonstorm-related variables included were month of the year, day of the week, and hour of the day. There was a slight increase in the reductions throughout the winter season and this was attributed to New Hampshire climatology (9). Winter storms were most frequent and caused the greatest amount of snow in late February and early March. The relationship between the reductions in traffic volume and day of the week was more complicated. Through the weekdays reductions did not seem to be dependent on location; however the reductions on weekends were more dependent on the location. The strongest relationship was between the statewide average hourly reductions in traffic volume and the hour of the day, shown in Figure 4. Reductions in traffic volume were greatest through the evening hours between 7 p.m. and 10 p.m. with the smallest reductions occurring in the early morning hours. However, further investigation showed that the number of cars missing from the roadways was greatest through the evening commute between 4 p.m. and 7 p.m.

The hourly reductions in traffic volume were linearly compared through regression to the weather variables listed in the methodology section. The R^2 values were used to determine relationship strength. The R^2 values shown in Table 2 indicated there were no strong relationships between the weather variables and reductions in traffic volume. However, linear relationships could not be used for the comparison of the wind direction, snowfall intensity, and visibility. The hourly reductions in traffic volume were plotted against the wind directions, where north is 0° , east is 90° , south is 180° , and west is 270° . The greatest reductions in traffic volume occurred with winds with a northeast wind direction shown in Figure 5. This was

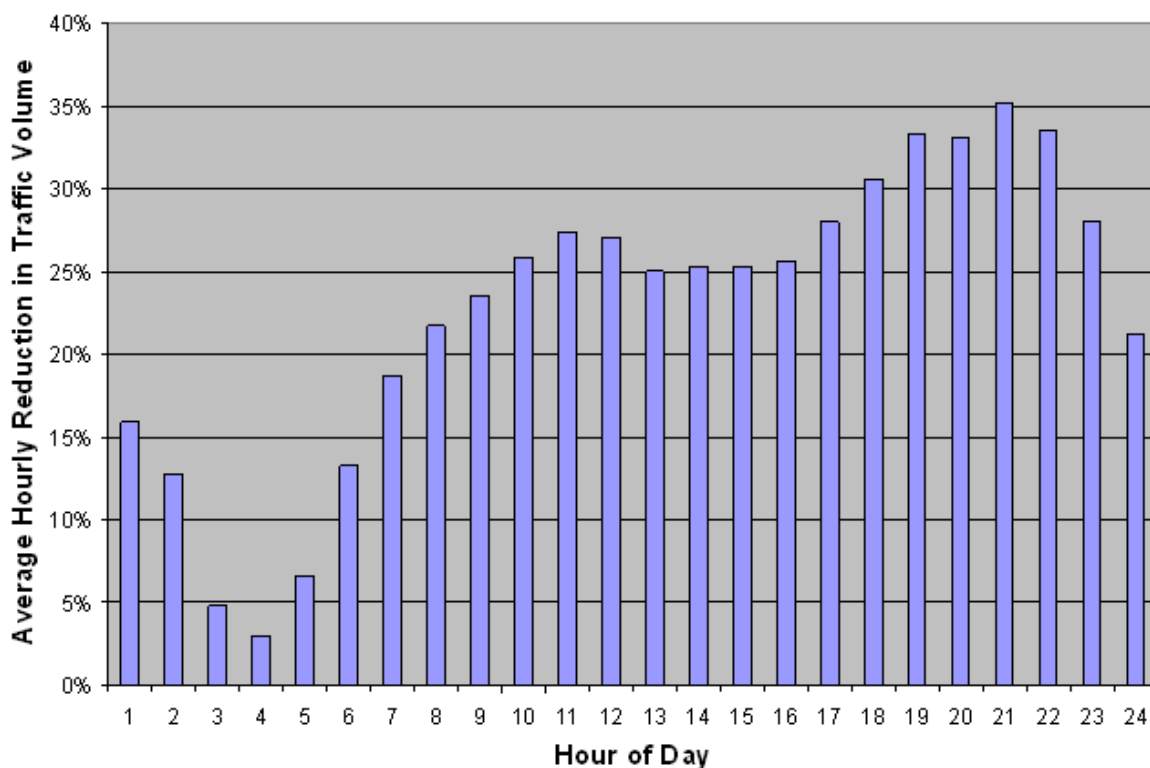

FIGURE 4 Statewide average hourly reductions in traffic volume by hour of the day.

significant because the climatology of New Hampshire stated that the most severe storms or the greatest snow-producing storms have north and east wind components. A direct relationship was found between snowfall intensity and the reductions in traffic volume where the greater the intensity the greater the reduction, shown in Figure 6. The comparison between visibility and reductions in traffic volume, shown in Figure 7, indicated an inverse relationship where the smaller the visibility the greater the reduction in traffic volume. Both visibility and snowfall intensity relate to the severity of a winter storm. Thus it can be determined that the weather variables that indicated storm severity have the greatest relationship with the calculated reductions in traffic volume.

TABLE 2 Relationship Characteristics Between Weather Observations and Reductions in Traffic Volume

Weather Variables	Slope	Y-Intercept	R ²
Temperature	-0.0077	0.4831	0.0409
Dew point	-0.0076	0.4813	0.0402
Relative humidity	0.0028	0.009	0.0124
Wind speed	0.0127	0.1777	0.0768
Wind gust	0.0137	0.1061	0.0557
Pressure	-0.003	3.2948	0.0177
Visibility	-0.0153	0.3235	0.0654
Ceiling	-0.0024	0.03031	0.0311

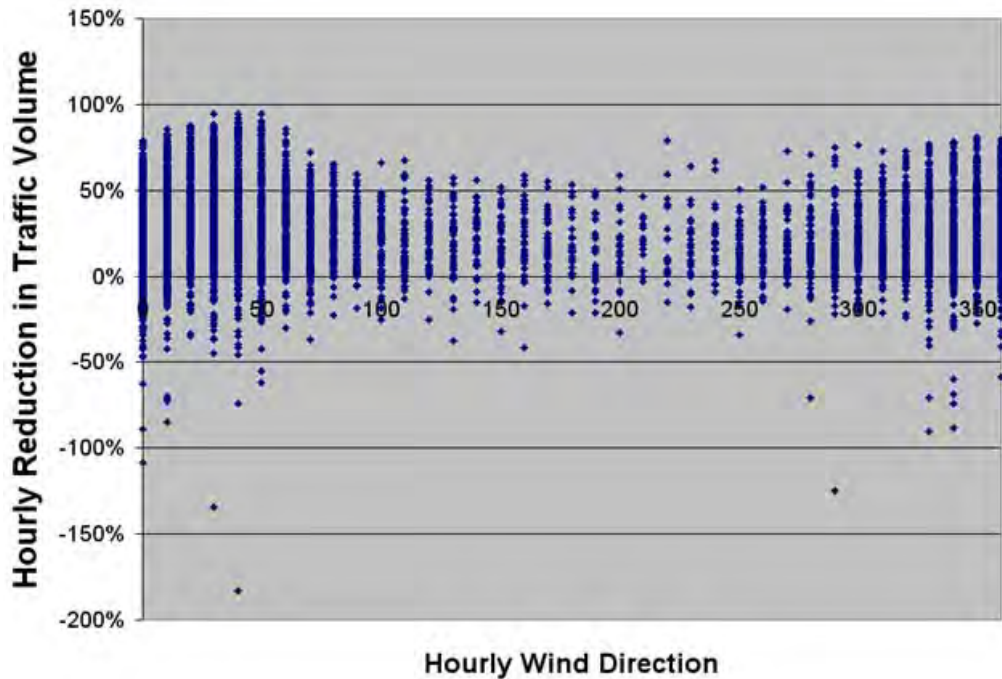

FIGURE 5 Reductions in traffic volume by wind direction.

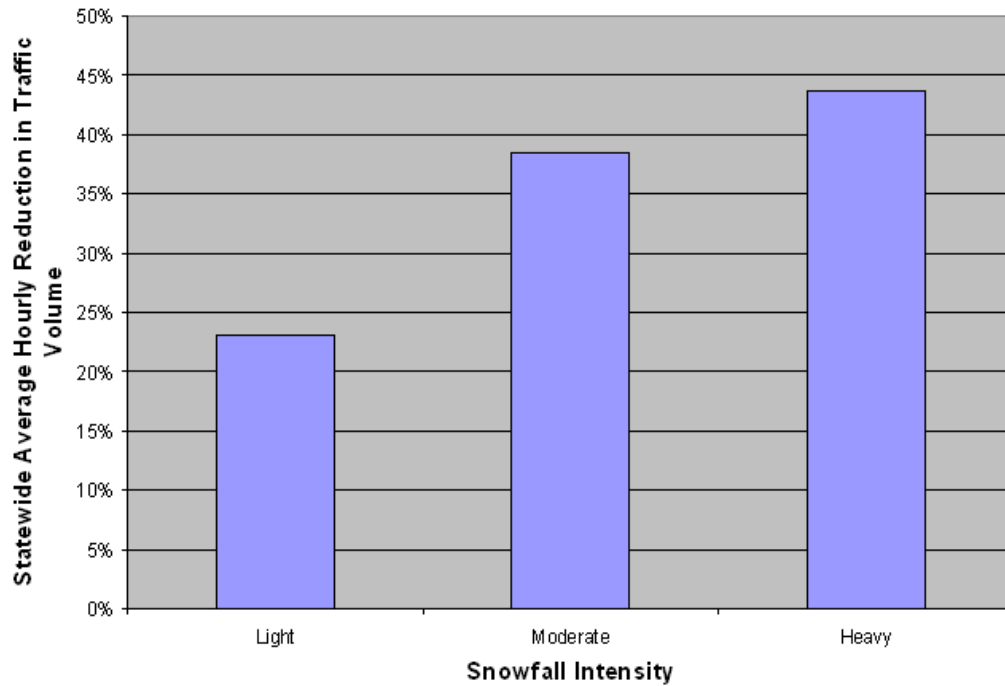

FIGURE 6 Snowfall intensity versus average reductions in traffic volume.

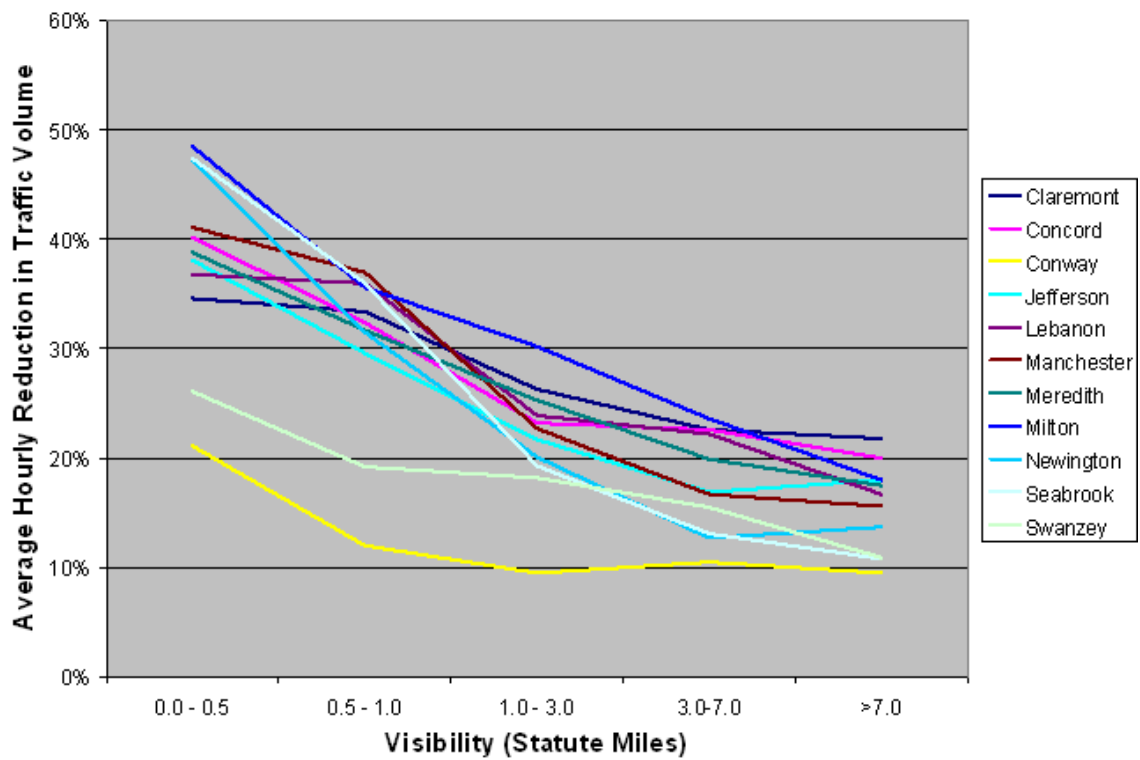

FIGURE 7 Visibility versus average reductions in traffic volume for each New Hampshire location.

Daily Reductions in Traffic Volume and Snowfall Measurements

The daily reductions in traffic volume were calculated for all storm days. These reductions in traffic volume were subject to greater variability because the duration of storms does not often fall on one single calendar day. Therefore the statewide average daily reduction in traffic volume of 14.59% for all storm days was smaller than the average hourly reductions. A storm average reduction was calculated for each storm event and then compared to the total storm snowfall for each location across the state. The results showed that the reductions in traffic volume for some locations were highly dependent on total storm snowfall whereas other locations were not as dependent. The R^2 values for the linear relationships are shown in Table 3. The relationship between the R^2 values and the average daily traffic volume from 2000 for each location indicated that the greater the average traffic volume at a location then the greater the reduction in traffic volume. This has been shown in Figure 8.

Generalizing the storm average reduction and storm total snowfall to a statewide storm average for both removed some of the variability across the state. It also gave a better sense as to which storms affected the state the most. A direct relationship was again found between the statewide average reductions in traffic volume and snowfall. The regression line indicated a fairly good fit to the data with an R^2 of 0.3861. The graphical comparison indicates a lot of variability with statewide average snowfall less than 5 in. By removing storm events with less than 5 in., an R^2 value of 0.536 is achieved, which provides a much stronger relationship between average daily reduction in traffic volume and average total snowfall.

TABLE 3 Strength of the Comparison of Hourly Weather Observations and Reductions in Traffic Volume

	Slope	Y-Intercept	R^2
All Locations	0.0125	0.0825	0.2266
Campton	0.01	0.1037	0.1119
Claremont	0.0128	0.0993	0.1957
Concord	0.0157	0.056	0.5239
Conway	0.0127	0.0611	0.2032
Hudson	0.0162	0.0169	0.3093
Jefferson	0.0135	0.1122	0.11
Lebanon	0.0084	0.1139	0.0876
Lincoln	0.011	0.0973	0.13
Manchester	0.0146	0.0693	0.6494
Meredith	0.0131	0.0808	0.3507
Milton	0.0169	0.1026	0.135
Newington	0.0166	0.0276	0.415
Peterborough	0.0073	0.1195	0.2006
Seabrook	0.0172	0.0809	0.3955
Swanzy	0.009	0.0646	0.3254

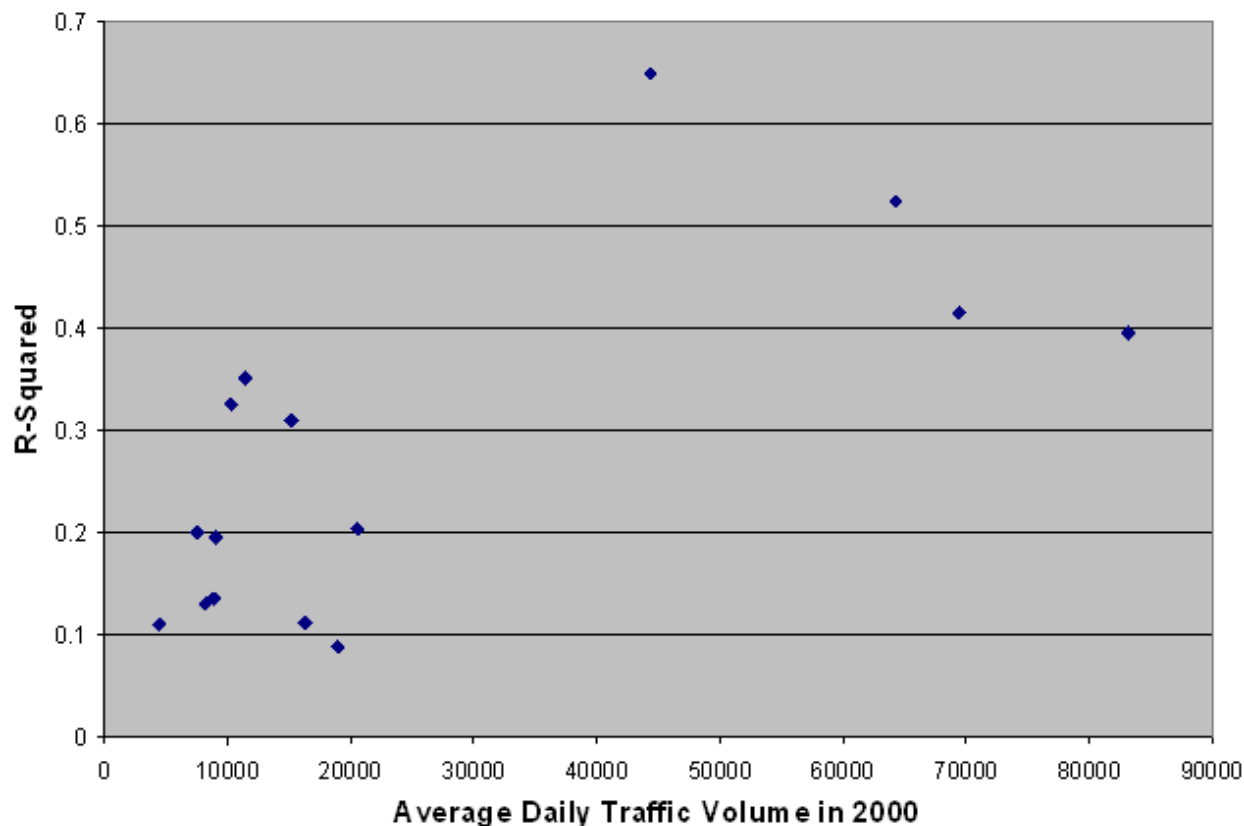

FIGURE 8 Daily traffic volume from 2000 versus the R^2 values.

CONCLUSIONS

This research provides an in-depth analysis of the reductions in traffic volume across the state of New Hampshire during winter weather events between November and March and between the years of 1999 and 2004. The average reduction in traffic volume varied greatly between individual storms and statewide. The statewide average hourly reduction in traffic volume for all events was found to be 22.2%. This percentage was very similar to the reductions in traffic volume in comparable research projects by Hanbali and Kuemmel (1), Knapp and Smithson (2), and Maze et al. (3).

The relationships between the reductions in traffic volume and the nonstorm-related variables such as month of the year, day of the week, and hour of the day revealed interesting results. Reductions in traffic volume increased by more than 5% between November and March suggesting drivers are more sensitive to winter weather in the later months of the year. However, the state climatology center of New Hampshire stated that the greatest frequency of winter storms occurs late in the season in the end of February to the beginning of March (9). It was found that reductions in traffic volume are related to the day of the week, with the greatest reductions in traffic volume on Tuesdays and Saturdays for the 4-year period. In addition, the variability of the statewide reductions in traffic volume is the greatest between Friday and Sunday. This suggests that the reductions are more dependent on location on weekends. A strong relationship between the average hourly reductions in traffic volume for each hour of the day

was found. The greatest reductions in traffic volume occur in off-peak travel times, during the late evening. The exception to this is through the early morning hours, when traffic volumes are so small that changes are negligible. However, there is the greatest number of vehicles absent from the roadways through the evening commute.

Relating the hourly reductions in traffic volume to hourly weather observations showed the strongest relationship to the weather variables indicating storm severity. These weather variables were determined to be wind direction, snowfall intensity, and visibility. Hours with the wind direction from the northeast had the greatest reductions in traffic volume, these storms commonly have been called nor'easters and have been known to bring the greatest amounts of snow to New Hampshire. In addition the hours with the highest snowfall intensity and the lowest visibility correlated best with the greatest reductions in traffic volume.

The average daily reductions for each location by storm compared to the storm total snowfall indicated stronger relationships for locations with larger traffic volumes than locations with smaller normal traffic volumes. The average daily reduction in traffic volume across the state was 14.59% for all storm days. A stronger direct relationship was found when the storm average reductions in traffic volume were averaged across the state and compared to the statewide average storm total snowfall. The relationship was especially strong for the storm events averaging greater than 5 in. of total storm snowfall across the state of New Hampshire.

The results of this research have been forward to the NHDOT in order to provide a better understanding of traffic volumes through winter weather events.

REFERENCES

1. Hanbali, R. M., and D. A. Kuemmel. Traffic Volume Reductions Due to Winter Storm Conditions. In *Transportation Research Record 1387*, Transportation Research Board, National Research Council, Washington, D.C., 1993, pp. 159–164.
2. Knapp, K. K., and L. D. Smithson. Winter Storm Event Volume Impact Analysis Using Multiple Source Archived Monitoring Data. Presented at 79th Annual Meeting of the Transportation Research Board, Washington, D.C., 2000.
3. Maze, T. H., M. Agarwal, and G. Burchett. *Whether Weather Matters to Traffic Demand, Traffic Safety, and Traffic Flow*. Aurora Program Center for Transportation Research and Education, Iowa State University, 2005.
4. New Hampshire Department of Transportation Planning Bureau. *Detailed Traffic Sheets*. Available at <http://www.nh.gov/dot/transportationplanning/traffic/trafficweb/DetailSheets/index.htm>. Accessed 2006.
5. Plymouth State University, Judd Gregg Meteorological Institute. Archived Meteograms. Available at <http://vortex.plymouth.edu>. Accessed 2007.
6. *New England Storm Reports, Snowfall Measurements*. National Climatic Data Center, National Oceanic and Atmospheric Association, 2007.
7. Cannon Mountain and Ski Resort. Snowfall Measurements 1999–2004. Available at Cannon Mountain and Franconia Notch State Park Headquarters, Franconia Notch Parkway, Franconia, New Hampshire.
8. National Climatic Data Center, National Oceanic and Atmospheric Administration. Accessed 2007.
9. National Climatic Data Center. *Storm Reports*. Available at <http://www4.ncdc.noaa.gov/cgi-win/wwcgi.dll?wwEvent~storms>. Cited 2007.
10. National Climatic Data Center. *Climate of the States, Climatology of the United States No. 60*. Available at http://hurricane.ncdc.noaa.gov/climatenormals/clim60/states/Clim_NH_01.pdf. Accessed 2005.

RELATIONSHIPS BETWEEN WEATHER EVENTS AND TRAFFIC OPERATIONS

Impact of Snow on Video Detection Systems at Signalized Intersections

JUAN C. MEDINA

MADHAV V. CHITTURI

RAHIM F. BENEKOHAL

University of Illinois, Urbana–Champaign

Video detection (VD) systems are increasingly being deployed instead of inductive loops for vehicular detection at signalized intersections. VD systems are easily adaptable to changing conditions without disruption to the traffic; however, VD systems' performance under inclement weather conditions may deteriorate. Four measures of performance were used to quantify the performance of VD systems from three manufacturers under snow conditions. It was found that under snow conditions more vehicles were not detected and more false activations were generated. Both of these have negative ramifications for the operation of a signalized intersection. This paper quantifies the proportion of detection errors under snow conditions (during daytime) with 9 h of data from 4 days. Under snow conditions it was found that at the stop bar locations, on the average 38% to 74% of the calls placed by the VD systems were false, and between 0% and 6.7% of the vehicles were missed, which translated to a total of 10 missed vehicles. All the systems failed to drop calls (ranging from 1% to 50%) at the stop bar after the vehicles departed. At the advance locations average false calls ranged from 8% to 75%, and the number of vehicles missed varied from 3% to 31%. As is evident from the high rate of false calls, regardless of which of the three VD systems is used, there can be a significant inefficiency in the operation of signalized intersections. This paper will discuss in detail the performance of each system when they are seen in the same image (side-by-side).

In recent years, the use of video detection (VD) systems in the United States has increased. However, limited research has been conducted on the VD detection performance under inclement weather conditions with large data sets. Past studies have focused on different aspects of the VD technology, providing valuable insight on specific issues. MacCarley (1), in 1998, evaluated the performance of the Vantage Video Traffic Detection System (VTDS) at three intersections under twelve conditions, with three of them including environmental factors (rain or wind), based on one 15-minute period for each condition. The results showed performance degradation during rain in daytime but not during nighttime, and an increase in missed calls in windy conditions.

In 2001, the Minnesota Department of Transportation (MnDOT) and SRF Consulting Group (2) evaluated the performance of VD systems at intersections. In this case Peek Video Trak 900, Autoscope 2004, EVA 2000, and TraffiCam systems were installed at different mounting locations and heights. Similar to the MacCarley study, data evaluation indicated that wind affected VD performance.

Also in 2001, Grenard, Bullock, and Tarko (3) evaluated Econolite Autoscope and Peek VideoTrak-905 for their performance at a signalized intersection. Results from overcast, night rain,

and partly sunny conditions from three days were presented. It was concluded that night-time detection was a concern and VD systems should not be used for dilemma zone protection.

More recently, a study by Rhodes et al. (4, 5) that followed the 2001 study by Grenard, Bullock, and Tarko (3) installed three systems next to each other: Autoscope (Version 8.10), Peek UniTrak (Version 2), and Iteris Vantage (Camera CAM-RZ3). Results from two full days of data were analyzed, and it was found that all the three VD systems had moderate to high degree of missed and false calls and none was superior to the others. Performance was found to deteriorate at night compared to daytime, with greater errors in rain conditions, but no other environmental conditions were evaluated.

Thus, while some researchers have studied the performance of VD systems under some conditions, using different setups, very little is known about the specific effects of weather-related factors. Limited information is available on VD performance under rain or wind, but previous studies have not analyzed other factors such as snow or fog.

This paper presents the results of an evaluation of three widely used VD systems under snow and wind conditions in a side-by-side setup based on large datasets. Performance under these conditions is contrasted with the performance under very favorable weather and lighting conditions to determine the impact of the inclement weather condition.

The next section provides a brief overview of the test location, the setup characteristics, and the data collection process; then, results are described and analyzed for stop bar and advance detection locations; and finally the conclusions are presented.

SETUP AND DATA COLLECTION

Data were collected on the eastbound approach of the intersection of Veteran's Parkway (U.S. Route 45) and South Century Boulevard in Rantoul, Illinois. The study approach has two left-turn lanes and a shared right-through lane. The speed limit on this approach near the intersection is 35 mph. In addition to the Illinois Department of Transportation (IDOT) cabinet that houses the controller for the intersection, a separate cabinet was installed to house the VD and the data collection equipment for this study. The VD systems did not affect the actual signal performance in any way.

Cameras from three manufacturers: Autoscope (SoloPro with Version 8.13), Peek (Unitrak with Version 2.2) and Iteris (Edge 2 with Version 1.08), were installed side-by-side on the luminaire arm facing the eastbound approach at a height of approximately 40 ft. No vertical extensions were used in this setup. Also, inductive loops (each 6 ft × 6 ft) were installed at the stop bar and advance locations (about 250 ft upstream the stop bar location) on all three lanes, resulting in six detection zones as shown in Figure 1. VD system manufacturers and distributors were informed about the installation, and both had the opportunity to provide input in setting up their respective VD system. In this study it was important to evaluate the video detection systems when the distributors and manufacturers were given the opportunities to set up their systems such that they would provide the "best performance." They were told where the cameras will be mounted and where the loop detectors are located, but they were not restricted by other conditions (e.g., field of view or location or size of detection zone). Therefore, manufacturers and distributors were given the freedom to choose the field of view and zoom level that would yield best performance, with the only requirement being placing detection zones on each lane at stop bar and advance locations. After feedback was received from preliminary analysis, two series of modifications from manufacturers and distributors were allowed to give them the opportunity to provide their "best configuration."

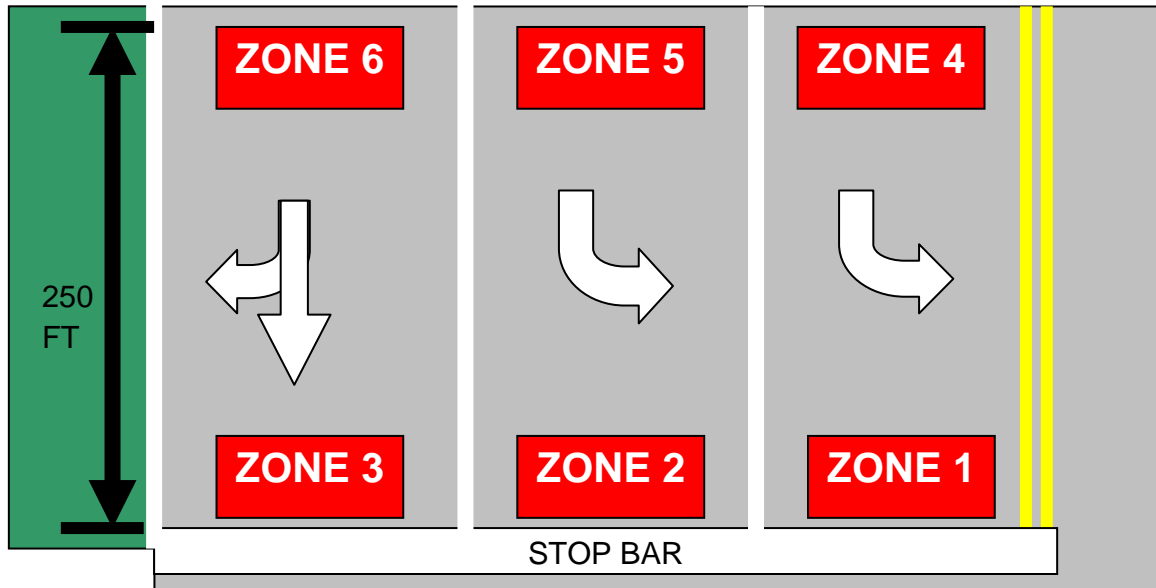

FIGURE 1 Schematic diagram of the study approach.

Two types of data were collected from the test site: times at which each of the VD zones or inductive loops were activated or deactivated (timestamps), and processed video images from the three video detection systems using an image divided in four quadrants. The fourth quadrant of the image displayed a real-time graph of the status of each VD and loop zone. Timestamps allowed for automated analysis of large data sets using a computer program that provided pointers for potential errors, and video images allowed for visual confirmation and ultimately quantification of the errors based on the initial time points from the computer code.

Four types of errors were quantified: false calls, missed calls, stuck-on calls, and dropped calls. The definitions of the four errors are provided below. (For further descriptions of the computer program logic, calibration, and validation procedures, the reader is referred to the report “Evaluation of Video Detection Systems” to be published in early 2008 by the Traffic Operations Lab of the University of Illinois and IDOT.)

- False calls were calls placed by the VD system when there was no vehicle in the video detection zone. False calls can have a negative impact on the operational efficiency of the intersection. The percentage of false calls was estimated as the ratio of the number of false calls to the total number of calls placed by the VD system. In the computer algorithm, for every call by a VD system, if there is no corresponding call from the loop detector, it is considered as a potential false call. Then, by watching the video tapes, it was determined if the potential false call was truly a false call.

- Missed calls occurred when the VD system failed to place a call when a vehicle occupied the video detection zone. These errors can have adverse safety effects due to potential red light runners in cases where the corresponding phase is not called by the controller or improper dilemma zone detection. The percentage of missed calls was estimated as the ratio of the number of missed calls to the total number of vehicles that actually traveled over the zone. In the computer code, for every loop call if there is no corresponding VD call, it is considered as a

potential missed call. Then, by watching the tapes, it was determined if the potential missed call was truly a missed call.

- Stuck-on calls were defined as those calls that were held by the VD system (given that a vehicle was detected correctly) after the vehicle left the video detection zone. Stuck-on calls can affect operational efficiency of the signalized intersection. The percentage of stuck-on calls was estimated as the ratio of the number of stuck-on calls to the total number of calls placed by the VD system. In the algorithm, if a VD call continues to be active more than X seconds after the end of the loop call, it is considered as a potential stuck-on call (X was equal to 10 s). Then, by watching the tapes, it was determined if the potential stuck-on call was truly a stuck-on call.

- Dropped calls occurred when a call by the VD system was dropped while the vehicle was still present in the video detection zone. If a VD system drops the call when the vehicle is still present, the vehicle may not get the proper phase or time to be served, which can create a potential safety concern. The percentage of dropped calls was estimated as the ratio of the number of dropped calls to the total number of vehicles that occupied the zone. In terms of the computer code, if the VD call is terminated more than X seconds before the end of a loop call, it is considered as a potential dropped call (X was equal to 5 s). Then, by watching the tapes, it was determined if the potential dropped call was truly a dropped call.

It should be noted that the inductive loops did not have any errors in detecting vehicles when the potential errors were manually verified (watching tapes). When there was any inconsistency between loop detectors and video detection zones, it was flagged out as a potential error and later was verified by observing the video tapes.

RESULTS

The performance of the VD systems for a scenario with inclement weather conditions (snow with wind) is presented in this section and compared with the performance of “base” data obtained from cloudy conditions with no wind. VD detection performance in cloudy conditions with “no wind” was used as a base for the comparisons because it has been observed to be the “best performance” (least amount of total errors). Several other conditions such as sunny with “no wind” and nighttime were also explored before researchers decided on the “best performance” condition. It is reasonable to find the “best performance” under cloudy conditions with no wind because shadows from direct sunlight do not reflect in pavement, potentially degrading performance on adjacent lanes, and the camera image does not have observable movement due to wind, which could also increase errors.

Based on observations from the videos, it was found that significant movement in the images was generated when the wind speeds were over 15 mph, thus “no wind” conditions refer to wind speeds lower than 15 mph, and “windy” conditions to wind speeds over 15 mph. In addition, snow data were collected when the roadway was partially covered with snow, with areas where the pavement was visible due to tire marks left by traffic. [Figure 2](#) shows images of the subject approach in cloudy condition (base) and in snow condition.

Data for the cloudy, “no wind” condition were collected from five different days (2 h each day) for a total of 10 h, and data for the snow condition were collected during 9 h from four

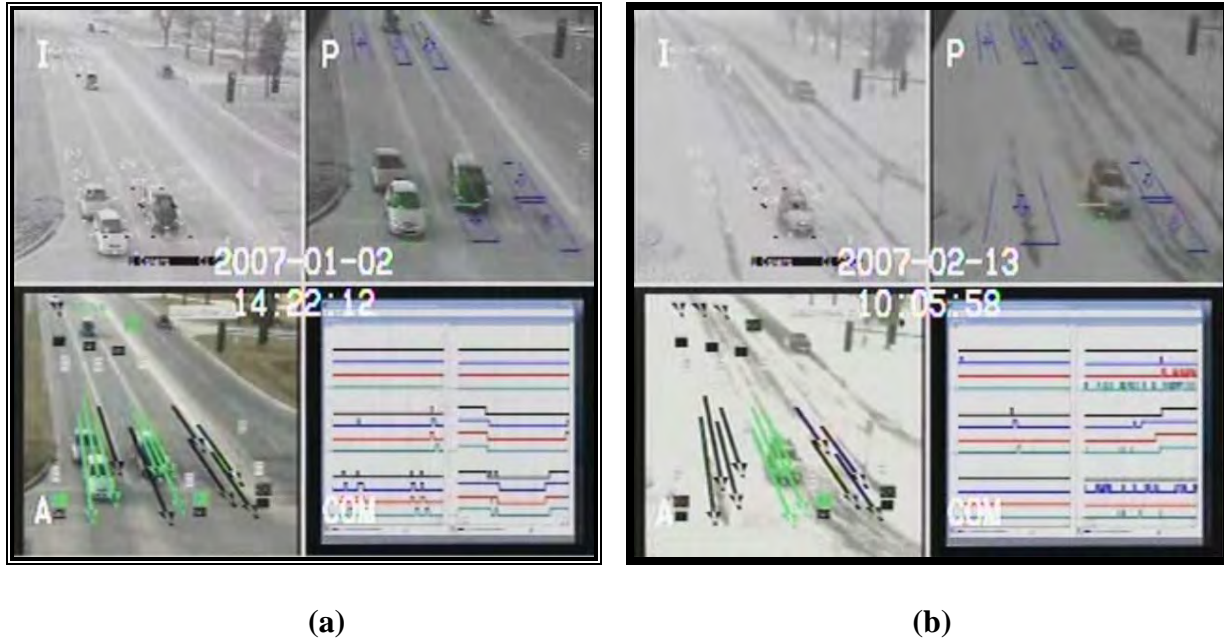

FIGURE 2 Sample images from (a) cloudy (base) and (b) snow conditions.

different days. All data presented in this paper were collected during daytime and were carefully selected to maintain similar weather and illumination conditions throughout the analysis period. Traffic volume in the cloudy “no wind” condition during the 10-h period was about 2,000 vehicles, and in the snow condition it was about 500 vehicles during the 9-h period.

The VD errors in snow conditions were compared with those in the cloudy “no wind” conditions (base). Figures in the following subsections show average, maximum, and minimum error, where each data point to construct the figures corresponds to a 2-h period except one data point in the snow data that corresponds to 1 h (recall that the total time analyzed was 9 h). The analysis of the errors at the stop bar zones and advance zones is presented separately.

Stop Bar Detection

False Calls

The false calls for the three stop bar detection zones in the base condition and the snow condition are shown in Figure 3. In Figure 3, each bar shows the minimum, average, and maximum values for each data set. False calls in the base condition occurred mostly in Zone 1 for all three systems, with averages between 9% and 20%, while in Zones 2 and 3 less than 3% of the calls were false. It is noted that the elevated percentage of false calls in Zone 1 was due to vehicles turning left from the center lane, when their image fell into Zone 1 (especially tall vehicles such as semi-trailers or trucks) or when they made a sharp turn and physically occupied a portion of Zone 1 or their image fell over it.

On the other hand, false calls in the snow condition were very high in the three stop bar zones for all VD systems. Statistical comparisons of false calls in the snow condition and in the base condition showed significant differences for all cases. For all three systems, on average

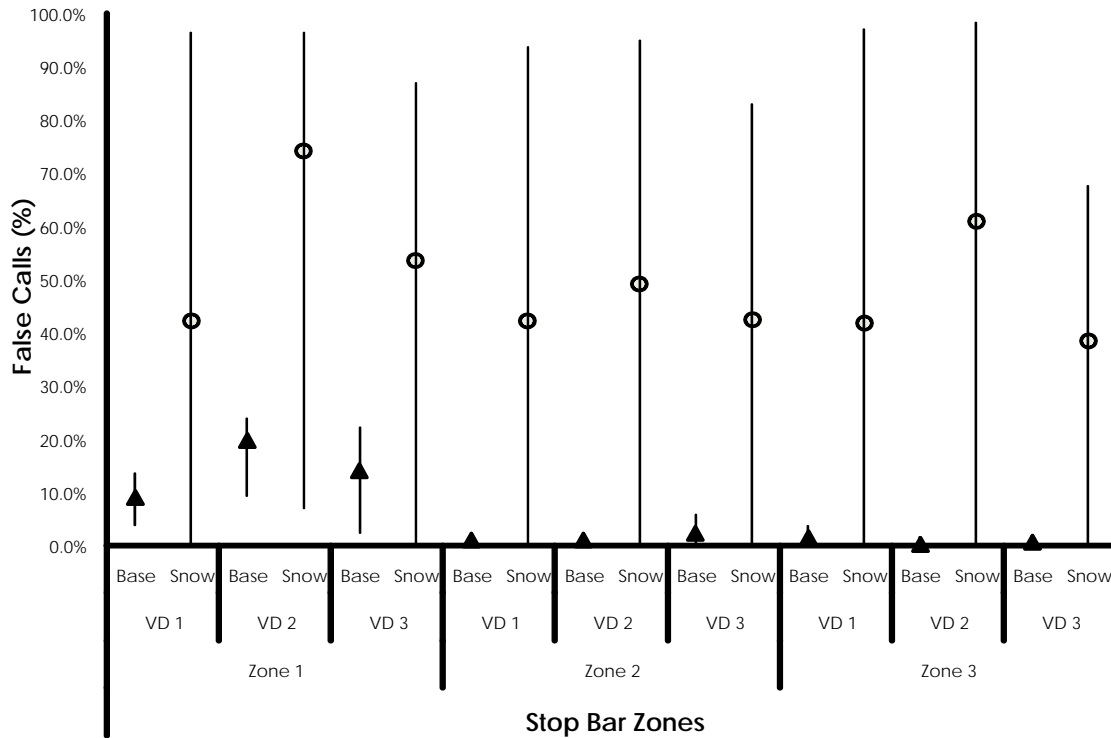

FIGURE 3 False calls in stop bar zones.

about 57% of the calls were false in Zone 1, about 45% in Zone 2, and about 47% in Zone 3. VD 1 had the lowest false call averages in all three zones, but they still accounted for at least 40% of the total calls.

From the manual verification of the videos, it was observed that the wind and the tire marks of the vehicles on the snow-covered roadway could be the main cause of the false calls on the stop bar zones. Tire marks were more visible on the leftmost lane (the one with highest volume), exposing more dark-colored pavement areas along the roadway and creating black/white contrast zones. This situation in combination with significant camera movement due to wind was observed to generate repeated calls without any vehicle being present. Thus, in the snow conditions there was a great increase in the occurrence of false calls in the stop bar zones, with great potential for deteriorating the traffic signal operation by placing numerous calls in the traffic signal controller without vehicles needing to be served.

Missed Calls

VD systems performed satisfactorily in the base condition in terms of missed calls, except for one vehicle missed in Zone 3 by VD 2. In snow conditions, however, up to 6.7% missed calls occurred in Zone 3, and 0.5% in Zone 1. This percentage may seem small but it translates to a total of 10 missed vehicles; nine of them missed by VD 2 (1 in Zone 1 and 8 in Zone 3) and 1 by VD 1 (in Zone 1), as seen in Figure 4. This constitutes a significant increase in the number of missed calls in snow conditions, but only for VD 2.

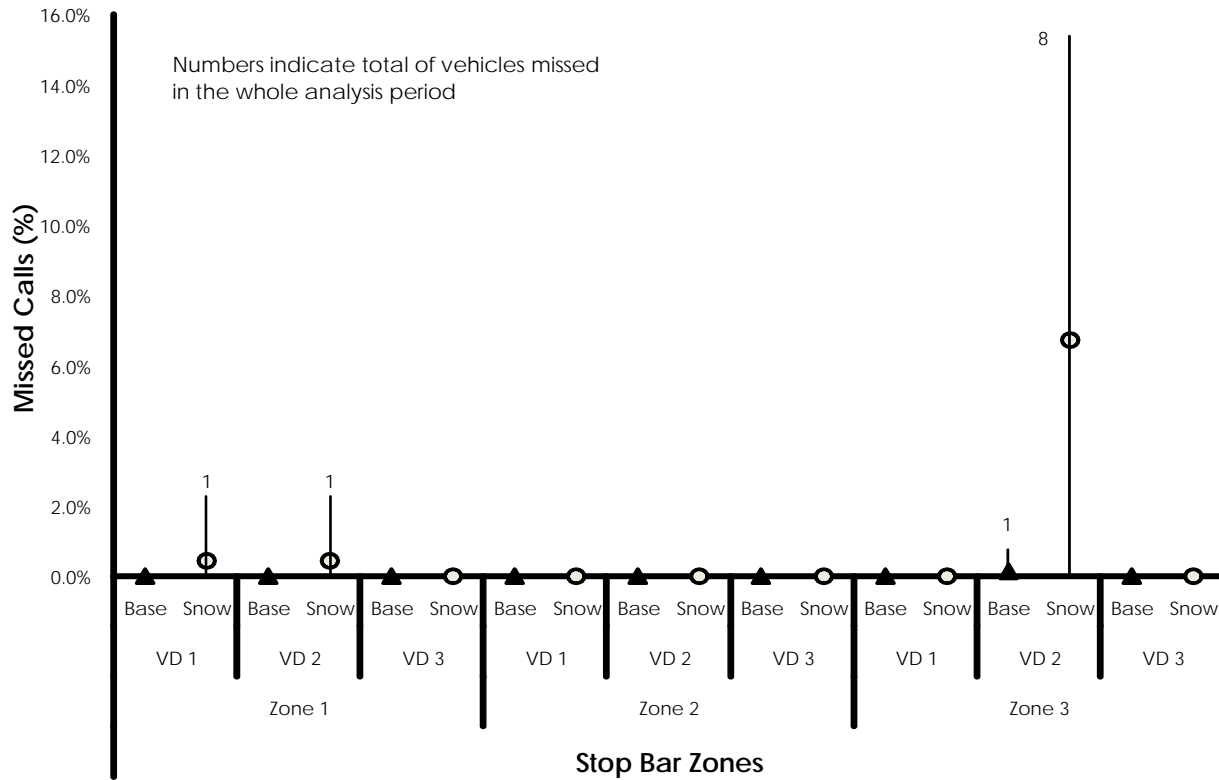

FIGURE 4 Missed calls in stop bar zones.

Missed calls did not happen systematically due to any specific reason observable from the video; thus it was not possible to identify their exact cause. The vehicle missed by VD 1 in Zone 1 was traveling on the left-most lane towards the edge with the center lane and passed the stop bar undetected and without stopping. Similarly, all vehicles missed by VD 2 traveled over the zone without stopping and were not detected.

Snow conditions seemed to significantly increase the number of missed calls for one VD system in one of the three stop bar zones, but did not increase the number of vehicles missed in the other two zones or in the other two VD systems.

Stuck-On Calls

Figure 5 shows the percentage of stuck-on calls in the base and the snow condition. No stuck-on calls were observed in the base condition, but an important increase in this error was observed for the three stop bar zones, especially for VD 1 and VD 3. The most significant increase in stuck-on calls was observed for VD 1, with more than 10% of the total calls from VD 1 in Zones 1 and 3 being stuck-on. Similar to missed calls, the exact cause of these errors was not clear from manually verifying the videos. Nonetheless, the snow conditions clearly increased stuck-on calls and further increased the potential for inefficient operation of the traffic signal, along with false and missed calls.

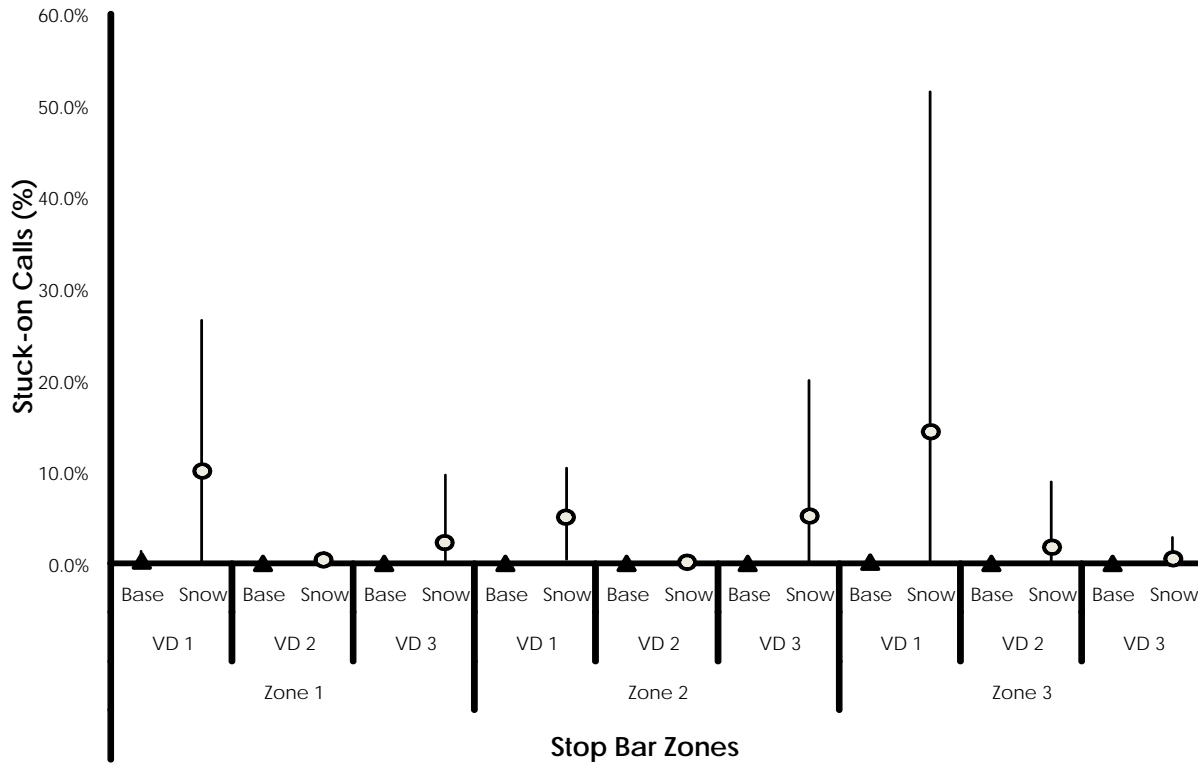

FIGURE 5 Stuck-on calls in stop bar zones.

Dropped Calls

No dropped calls by any of the three VD systems were observed at the stop bar locations in the base or the snow condition.

Advance Detection

False Calls

In the base condition, performance of VD systems in terms of false calls was good in two of the three advance zones: in Zone 6, average false calls were less than 1% of the total number of calls, and in Zone 5 averages were below 3.5% (Figure 6). However, Zone 4 had a considerably higher number of false calls that represented averages of 5% in VD 1, 17% in VD 2, and 11% in VD 3. It was observed that false calls in Zone 4 during the base condition were mainly due to: tall vehicles traveling in the center lane and placing a call in Zone 4 and in Zone 5 and to vehicles changing lanes between the center lane and the leftmost lane that also placed two calls (one in Zone 4 and one in Zone 5).

False calls significantly increased in the snow condition for all systems and all advance zones, Zone 4 being the most affected with averages over 45%. Lower average false calls were observed in Zones 5 and 6, ranging from 8% to 42%. The higher impact of snow conditions on Zone 4 could be caused by the combination of significant camera movement due to wind and the

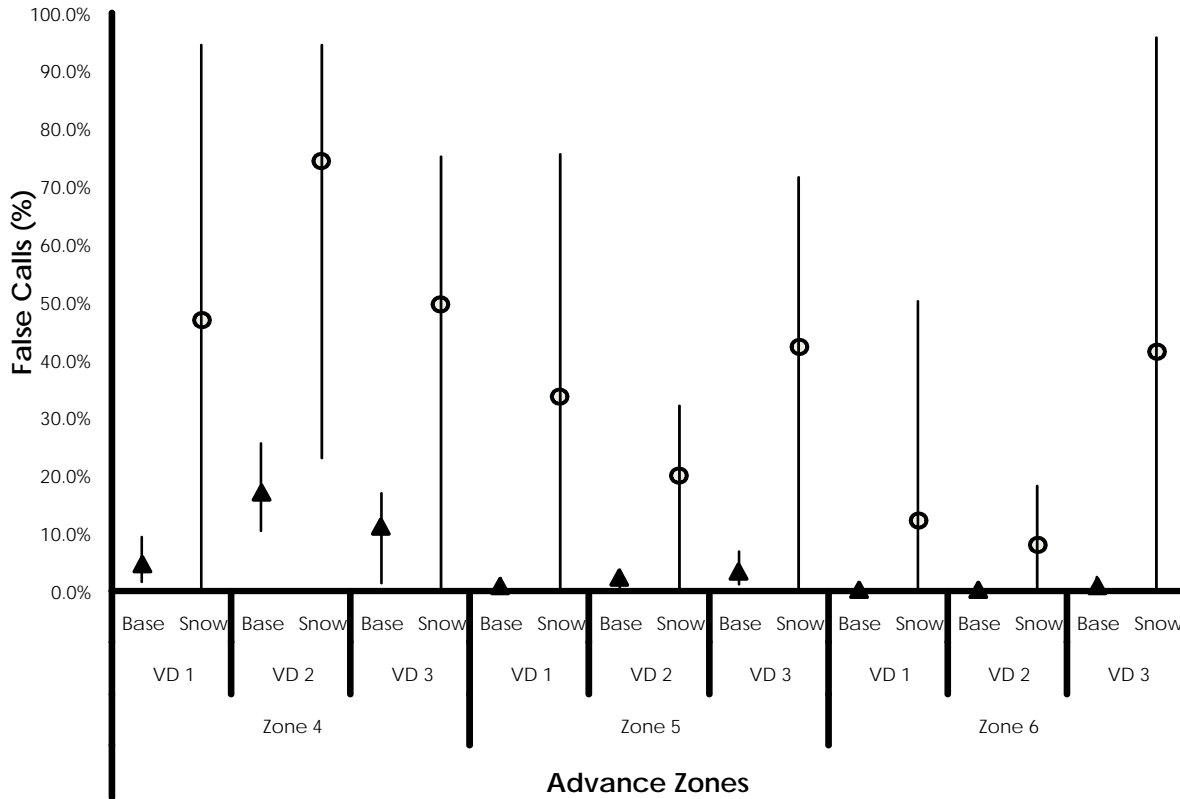

FIGURE 6 False calls in advance zones.

more visible tire marks that exposed the pavement on areas closer to the median (and over Zone 4), generating contrast changes on the background. This situation is similar to that described for the stop bar zones but with tire marks clearly visible only on the left-most lane, and not on the three traveled lanes.

Missed Calls

A significant increase in missed calls was observed for all systems in all three advance zones in the snow condition compared to the base case (Figure 7). In the base case, missed calls accounted for an average of less than 3%, but still represented an important number of vehicles: 20 vehicles in VD 1, 14 vehicles in VD 2, and 39 vehicles in VD 3. In the snow condition, the most unfavorable case was observed for VD 2, which missed more than 20% of the vehicles in each of the zones, for a total of 157 vehicles across the three lanes. The other two VD systems also missed an important number of vehicles that accounted for an average of about 9% of all traffic in VD 1 and 11% in VD 3.

A possible cause for the significant increase in the missed calls in the advance zones under snow, and for the relatively minor effect of the snow in the stop bar zones, could be the reduction in visibility due to the inclement conditions, as observed during the manual verification of the videos. Then, it is reasonable to believe that the combination of a greater distance from the camera location to the advance zones (about 250 ft upstream of the stop bar) and the poor visibility

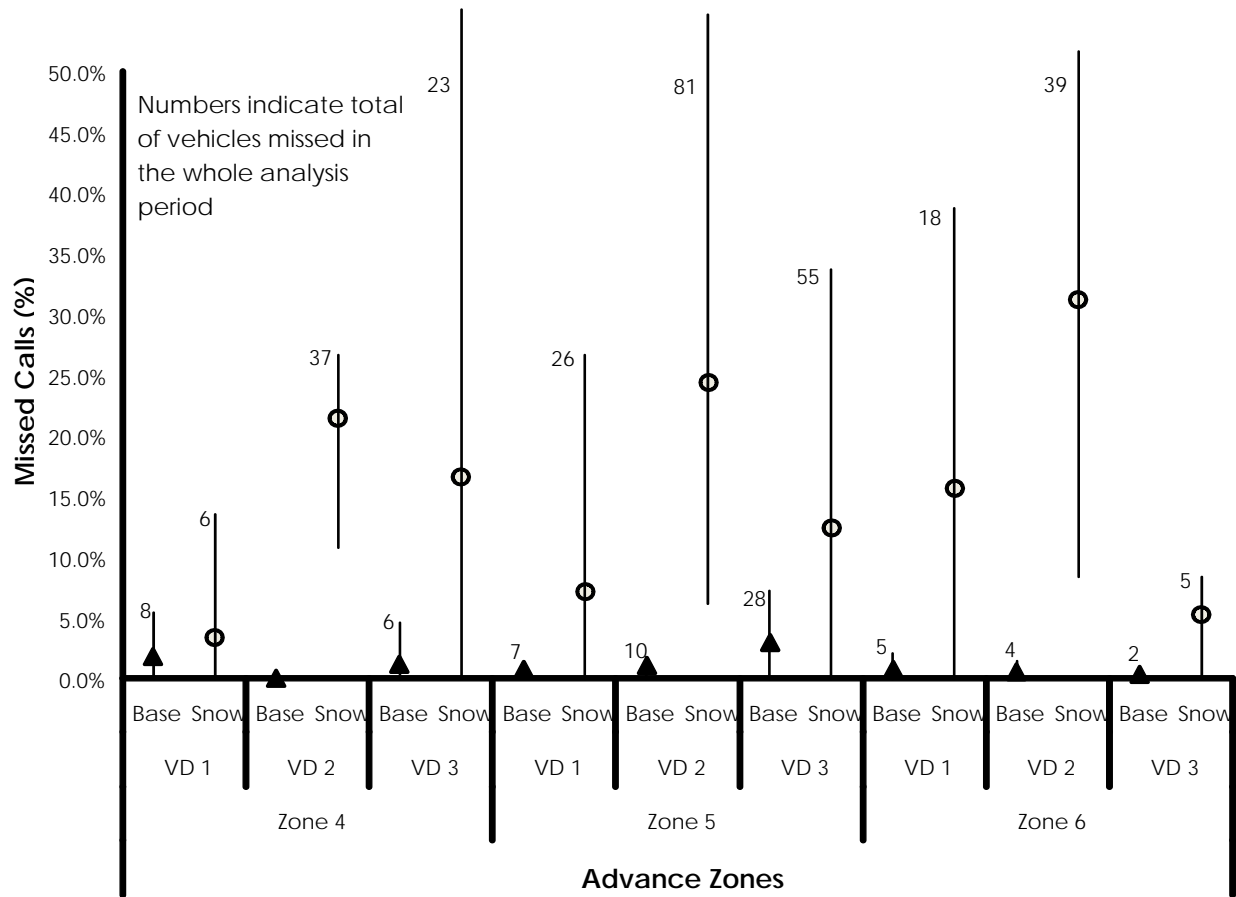

FIGURE 7 Missed calls in advance zones.

conditions deteriorated the zones' detection capabilities in a much greater proportion compared to the stop bar zones, generating missed calls.

Stuck-On Calls

Only one stuck-on call was observed in the advance zones, and it occurred during the base condition. This was a rare occurrence and there was no clear cause from the manual verification of the videos. Thus, no evidence indicating significant increase or decrease in the number of stuck-on calls in the advance zones due to snow and wind was found.

Dropped Calls

No dropped calls by any of the three VD systems were observed at the advance locations in the base or the snow condition.

CONCLUSIONS

The performance of three VD detection systems under the snow condition was compared to that under the “best performance” condition (cloudy noon). False calls significantly increased in both stop bar zones and advance zones, with average percentages ranging between 38% and 74% in the stop bar zones, and between 8% and 75% in the advance zones. Missed calls also increased but mostly in the advance zones, where between 3% and 31% of the vehicles were missed in each lane. In addition, stuck-on calls increased in the stop bar zones, with averages lower than 15% of the total calls. No dropped calls were observed in any of the two conditions analyzed.

Thus, data indicate that given the significant increase in the occurrence of errors, the performance of the traffic signals at intersections using video detection systems could deteriorate significantly due to snow and wind conditions. The increase in detection errors could lead to deterioration in the operational efficiency of the signal (false calls) and also to potential safety concerns (missed calls) due to undetected vehicles.

REFERENCES

1. MacCarley, A. *City of Anaheim/Caltrans/FHWA Advanced Traffic Control System Field Operational Test Evaluation: Task C Video Traffic Detection System*. California Polytechnic State University, San Luis Obispo, 1998.
2. MnDOT and SRF Consulting Group, Inc. *Evaluation of Non-Intrusive Technologies for Traffic Detection. Evaluation Test Plan*. Vol. 1. Minneapolis, Minn., 2001.
3. Grenard, J., D. Bullock, and A. Tarko. *Evaluation of Selected Video Detection Systems at Signalized Intersections*. Publication Rep. FHWA/IN/JTRP-2001/22. Purdue University, West Lafayette, Ind., 2001.
4. Rhodes, A., E. J. Smaglik, and D. Bullock. *Vendor Comparison of Video Detection Systems*. Publication Rep. FHWA/IN/JTRP-2005/30. Purdue University, West Lafayette, Ind., 2006.
5. Rhodes, A., E. J. Smaglik, D. M. Bullock, and J. Sturdevant. Operational Performance Comparison of Video Detection Systems. *Proc., 2007 ITE International Annual Meeting and Exhibit*, Aug. 5–8, 2007.
6. Chitturi, M., J. C. Medina, and R. F. Benekohal. Accuracy of Video Detection Systems for Traffic Counting. *Proc., 2007 ITE International Annual Meeting and Exhibit*, Aug. 5–8, 2007.

Relationships Between Winter Service and Weather

RELATIONSHIPS BETWEEN WINTER SERVICE AND WEATHER

Modeling Winter Maintenance Activities Using Classification Trees

JEAN ANDREY
ALEXANDER BRENNING
DENIS KIRCHHOFF
University of Waterloo

BRIAN MILLS
Meteorological Service of Canada, Environment Canada

MAX S. PERCHANOK
Ministry of Transportation, Government of Ontario

Winter severity models have been developed by and for road authorities throughout North America and northern Europe. These models are reviewed with particular attention given to the modeling approach, the temporal–spatial unit of analysis, the characterization of winter weather and winter maintenance activity, and both the robustness and the usefulness of results. A new approach that addresses many limitations of past models is then explored by using automatic vehicle locator data for one season and one patrol near Ottawa, Canada. With hourly salt application rates as the dependent variable and various sources and types of forecast and observed weather conditions as the independent variables, five different treatment modes are modeled by using classification trees. Results are promising in terms of both the accuracy of predictions and the ability of this inductive approach to identify key explanatory variables and related threshold values that affect the probability of different treatment options.

Winter weather creates mobility challenges for all northern jurisdictions. Each year, road maintenance authorities in Canada spend on the order of \$1.3 billion on snow removal and other winter maintenance activities (1). As well, the science and management of snow control is evolving quickly and increasingly involves private firms that enter into contractual arrangements with governments.

Various documents identify best practices in winter maintenance (2). However, to further improve performance, there is increasing interest in the development of tools that link operations to winter weather. One application of such tools, as exemplified by the FHWA maintenance decision support system, is to provide better and more specific road weather forecasts that prescribe optimal treatment from an effectiveness and efficiency point of view (3,4). For more strategic applications, other models of resource use have been developed. For example, winter indices have been used to normalize for differences in weather from year to year to explore the effectiveness of alternative technologies or operations (5). These models can also provide a basis for evaluating the appropriateness of cost-sharing adjustments for contracted services and can facilitate the sharing of expert knowledge across service areas and service providers.

Over the past two decades, several winter severity indices–models have been developed by or for road authorities in North America and northern Europe. These studies are reviewed with particular attention given to the general modeling approach, the temporal–spatial unit of

analysis, the characterization of winter weather and winter maintenance activities, the robustness of the results in light of statistical properties of the data such as nonlinear relationships or interactions between variables, and the usefulness of the results for improving winter road maintenance operations.

The paper then presents preliminary results from an approach that addresses many limitations of conventional approaches. Using automatic vehicle locator (AVL) data from one patrol yard in the Province of Ontario, Canada, the authors explore the potential benefit of modeling salt use at the truck level on an hour-by-hour basis using classification techniques. In this exploratory analysis, we use classification trees as an example of a classifier that is designed to sort and distinguish a large number of explanatory variables that may be correlated with and influence each other in their relationship to the dependent variable. This approach will help identify future directions in modeling winter maintenance activities using, for example, a combination of tree-based and linear classifiers as provided by the machine-learning approach of bundling classifiers (6).

REVIEW OF PAST MODELS

General Approach Including Temporal–Spatial Unit of Analysis

In any modeling exercise, it is important to begin with a conceptualization of what it is that we want to understand. In modeling winter maintenance, the dependent variable is usually some measure of resource use, which is based on a sequence of human responses to a combination of expected and observed physical conditions. As a result,

1. Human behavior in the form of operation decisions is, in essence, the process that we are trying to understand and prescribe in models of winter road maintenance. Accordingly, any model of past activity will likely have a local signature; that is, it will incorporate local knowledge and will reflect local practices. Since it is reasonable to assume that different combinations of activities may have similar effects with similar costs (3), it is unrealistic to expect that identical weather and road conditions will result in identical treatment on an hour-by-hour and truck-by-truck basis. This has implications for the generalizability of model specifications—an issue that requires more attention than has been previously acknowledged.

2. Operational decisions (and adjustments to those decisions) are made continuously at the truck or patrol level; discerning the effect of such decisions requires data in small units of time and space. Therefore, even in instances in which fine-scale predictions do not produce excellent fit or only aggregate results are required for decision making, it is important to work with a small temporal–spatial unit of analysis if error terms are to be understood and models are to be improved.

3. Although maintenance activities when aggregated over time and space define continuous variables (e.g., weekly salt totals, seasonal equipment hours), individual decisions are usually categorical. Indeed, the decision to treat is binary, and there is a finite number of discrete treatment modes used by any one truck on any single highway segment. It is therefore important to explore modeling approaches that are consistent with the inherent nature of the dependent variable(s).

Despite the importance of the above issues, most past models have oversimplified the characterization of decision making by maintenance personnel, have modeled maintenance activity in coarse temporal–spatial units, and have treated the dependent variable as continuous. Examples of such models include the Hulme (7,8) and SHRP (5,9,10) indices.

Explanatory Variables

Winter maintenance activities vary over time and space because of differences in local weather, road system attributes and maintenance practices, for example, materials used. Most models, however, concentrate mainly on atmospheric and road conditions, since inclement weather is the catalyst for response. Most early models were limited in their characterization of weather, relying on a few standard weather observations from a nearby weather station (e.g., temperature, snowfall amount) (5, 9–13), but recent studies are drawing on a greater variety of data sources and incorporating more weather variables (2,14). Because of improved availability of data, the research community is now at a point where it can incorporate forecast and ambient weather conditions, as well as information on road surface conditions in winter maintenance activity models. The inclusion of forecast information is particularly critical, as decisions are made on the basis of expected, as well as observed, conditions.

Model Fit, Robustness, and Usefulness

In terms of the modeling approach, some studies begin with no prior assumptions about the importance of specific weather variables (13), while others attempt to capture different types of treatable events; an example of the latter is the inclusion of snowfall and frost events as additive terms in the SHRP model (5). Regardless, most models are based on some type of regression modeling and thus are constrained by the issue of multicollinearity and the limitations of linearly additive models. Alternate approaches, such as storm event classifications (15), are also being explored, but their association with specific treatments has yet to be objectively validated by treatment data.

In terms of model fit, some past studies have report R^2 values greater than 0.9 (5,16), but these are based on highly aggregated data. In addition, when transferred to other regions, these models do not perform well, even when recalibrated locally (9,10). Models that have been developed at somewhat finer temporal–spatial units (14) typically have achieved much poorer fit, also limiting their usefulness. There is the added problem that some key variables produce different coefficients in different circumstances, and in virtually all cases assumptions about data distributions, linearity and independence are violated. The net effect is that many winter severity indices are useful only for benchmarking use of materials from season-to-season in the same geographic area.

CASE STUDY

Modeling Approach and Study Area

The current project introduces a new approach for modeling winter maintenance activities and is developed with data from two trucks, 7815 and 7818, that operate on Highways 417 and 138,

respectively, in the Province of Ontario, Canada. These highways are located in the VanKleek Hill patrol of the Ottawa District. Highway 417 is a four-lane freeway of Winter Service Class 1, running 135 km from Ottawa, Ontario, toward Montreal, Quebec, whereas Highway 138 is a 35 km, Class 2, 2-lane rural highway. Winter Service Class 1 stipulates that snow removal begins before 2.0 cm of snow accumulation on the roadway, plowing and salting continues with 1.3 hour circuit time, and pavement is essentially bare within 8 hours of the end of the storm. Service Class 2 stipulates a 1.8-h circuit time and that pavement is essentially bare within 16 h. Winter sand is applied when temperatures fall below -12°C and snow cannot be removed by plowing and salting. In addition, anti-icing liquid is applied by truck to bridge decks and other ice-prone spots on Hwy 417 in advance of storms, except at one location where it is applied by a fixed automated spray technology (FAST). Granular salt is pre-wetted with anti-icing liquid and applied at rates varying with pavement temperature and snowfall, from 50 to 170 kg/2-lane km (6.8 to 23.3 g/m²). Plows and combination plow–spreader units are used to anti-ice and clear snow. Winter operations are planned using data from the provincial roadway weather information system (RWIS).

Dependent Variable

Winter maintenance activity data were extracted from the InterFleet Internet-based system of AVL data. These were extracted by using the “Query” and “Winter operation report” (WOR) functions and were downloaded as CSV spreadsheets.

The query function, which provides readings in time intervals as short as 5 s, was used to extract details on maintenance operations. Each reading provides information on materials used, driving speed and exact location. Data were extracted for one season, from October 1, 2004, to April 30, 2005. During this time period, there were 133,251 readings for truck 7815 and 110,532 for truck 7818.

Winter operation reports were used to validate daily and seasonal materials usage. They provide information on trips, such as vehicles entering and leaving Ministry of Transportation, Ontario (MTO), yards and include the date of the report as well as the start time and return-to-yard time. They also include total kilometers serviced, material usage, and average rate of application.

The unit of analysis adopted for the study is the truck hour. A spreadsheet was developed: each row represents a unique hour for one truck, and the columns include information on the dependent variable (treatment activity) and the independent variables (primarily weather variables). To simplify the task, we focused only on material application rates and used these to create what we called “treatment modes” (e.g., a treatment mode of 65-39 means that the salt application rate was 65 kg/driving kilometer and the prewet application rate was 39 L/tonne of salt).

Preliminary examination of material applications indicated that (a) a finite number of treatments was used by a truck, (b) event-based treatment patterns were not the same for the two trucks, and (c) even within treatment periods, treatment was not always continuous and material application rates varied, often within individual hours. Therefore, it was important to proceed with caution when creating the dependent variable for the modeling exercise.

The first step taken was to aggregate the AVL readings for an individual truck for each hour by using pivot tables so that the frequency distribution of treatment modes, such as application rates of salt and prewet, could be examined. An hour in which the truck was out for the whole 60 min produced approximately 300 readings, but this varied depending on how the

truck was operating, such as, spreading salt or just plowing. This pivot table was then used to determine the “dominant mode” for that hour. More specifically, if during a one-hour period the vehicle had more that 75% of the readings recorded as no materials used, then that hour was assigned to either a nontreatment period (recorded as n/a in subsequent tables and figures) or to a treatment mode of zero. The separation of these hours into two classes required prior definition of treatment periods, based on temporal patterns of weather and salt use as well as expert judgment. If material application had been observed for at least 25% of the readings in an hour, then the mode that had the most readings was chosen as the dominant mode for that hour. Sensitivity analysis was performed with different cutoff values and assignment rules, but the above worked comparatively well in reproducing daily and seasonal salt usage.

Second, the hourly treatment modes were combined with average truck speed and the percentage of the time that treatment occurred in treatment hours to estimate daily and seasonal salt use. Figure 1 presents a comparison between the daily estimate and the actual amount of salt used for truck 7815 for the whole season. On a seasonal basis, the estimate of dry salt usage is within 5% of actual usage. On a daily basis, the fit for the winter season of 2004–2005 is within 30% and 1 tonne for most days (47 out of 56 days for truck number 7815, and 45 out of 46 days for Truck Number 7818). This suggests that if the modeling exercise can accurately assign hours to a treatment mode, then it will be possible to estimate seasonal salt usage with a high degree of accuracy and daily or storm-level salt usage with a fair degree of accuracy.

Because the number of treatment modes was still fairly large after the assignment, as described above, we further simplified the dependent variable as follows. Each hour was assigned to one of the following categories of dry salt usage: n/a (hour is not in a treatment period), zero (hour is in a treatment period but no dry salt was applied), low (~50 kg of salt per lane kilometer), medium (~65 kg of salt per lane kilometer), and high (~85 kg of salt per lane kilometer).

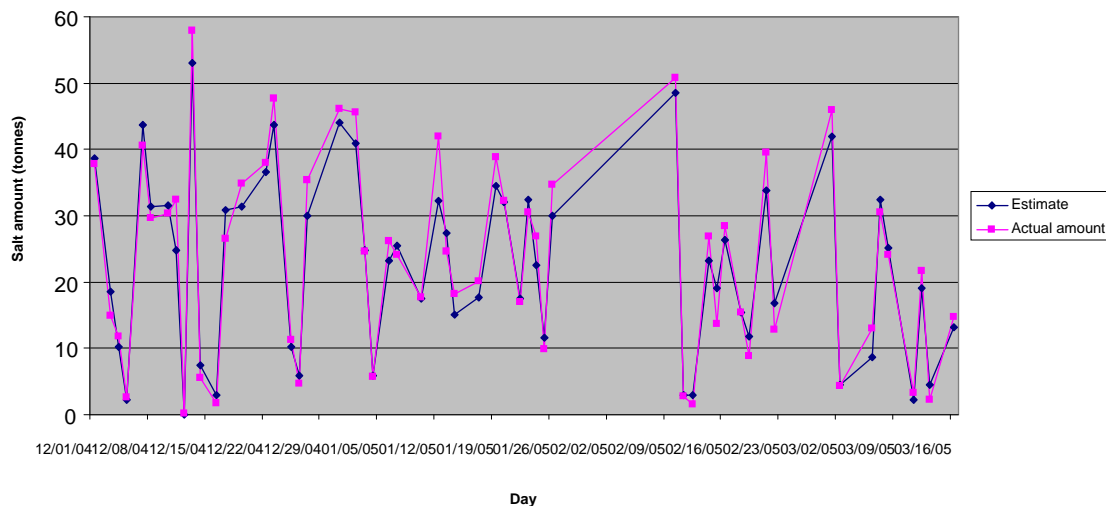

FIGURE 1 Comparison between daily estimate and actual salt use (Truck 7815).

Explanatory Variables

A summary of the explanatory variables incorporated in the analysis is presented in Table 1. The selection of variables was driven by two primary assumptions: (a) winter maintenance operations are influenced by the expected occurrence or actual occurrence of particular weather and road conditions and (b) the frequency, timing, intensity, and duration of these conditions are related, though not necessarily directly–linearly, to the level of winter maintenance effort. Thus variables describing both forecast and observed conditions were sought. In general, the location and spatial–temporal resolution of the dependent variable dictated the form of the explanatory variables.

Weather forecast and warning data were obtained from Environment Canada for the Prescott and Russell forecast region in which the study area is located. Short-term weather forecasts issued in the afternoon of a given day predict conditions for that night and the following day. For the analysis, we have assumed that tonight conditions are valid from 1800 through 0500 hours and tomorrow conditions represent 0600 through 1700 hours. Inclusion of forecast variables is an explicit attempt to recognize the decision-making behavior of maintenance staff in advance of sensible weather or road conditions. Like forecasts, the issuance of weather warnings (watches, warnings, or advisories) is assumed to provide maintenance personnel with early notice of treatable events and greater confidence that they will occur.

TABLE 1 General Description of Explanatory Variables

General Category	Temporal Resolution	Variable Description
Weather forecasts	Semi-daily (tonight 1800–0500/tomorrow 0600–1700)	Occurrence, type, amount, and probability of precipitation Occurrence of blowing snow Temperature and trend
Weather warnings	Hourly	Watches, warnings, and advisories for winter storm, heavy snowfall, freezing rain, flash freeze, or blowing snow conditions
Standard weather observations	Hourly	Visibility, wind speed and direction, air and dewpoint temperature Occurrence, type, and intensity of precipitation occurrence of blowing snow
	6 hourly	Liquid-equivalent precipitation accumulation
	Daily	Snowfall, rainfall, and total liquid-equivalent precipitation accumulation Minimum, maximum, and mean temperature depth of snow on the ground
Radar-derived observations	Hourly	Presence of precipitation near or over study area Estimated average and peak precipitation intensity over study area
Road weather conditions	Hourly	Air and dewpoint temperature Occurrence, type, and intensity of precipitation Pavement surface temperature Road surface condition (e.g., dry, wet, icy, etc.)

As noted, past research efforts have often relied exclusively on standard weather observation data to model road salt and other measures of winter road maintenance. Although the current study incorporates other sources of information, standard observations are also an important set of explanatory variables. Data for the variables identified in Table 1 were obtained from Environment Canada for the Ottawa MacDonald–Cartier International Airport observing station. While this is the closest primary observation station—and thus collects the full suite of required variables with high quality and continuity—it is situated in the extreme northwest corner of the study area and may not be fully representative of conditions, especially for precipitation.

Inclusion of radar-derived estimates of precipitation occurrence and intensity should help to address inadequacies in standard observations related to areal coverage. Hourly radar imagery (CAPPI, snowfall mode) was obtained through Environment Canada for the Franktown radar station located about 80 km west of the study area. For the pilot study, images were subjectively interpreted to determine the location and intensity of precipitation.

RWIS can also be used to improve the spatial representativeness of standard observing stations and, more importantly, provide several variables unique to the road condition. Hourly measurements were selected or derived from data for the Casselman RWIS station (Eastern Region-16) obtained from MTO.

For this exploratory work, highway geometrics and other road attribute data were not included. However, potential influences related to the different highway segments and to seasonal and diurnal variations were represented by candidate variables truck, month, and hour.

Classification Techniques

A classifier is a function that predicts the (unknown) class membership of an object on the basis of (known) explanatory variables. In supervised classification, this function is fitted to a training data set for which the class membership of each object is known. In the present setting, the objective was to model the ordinal-scale treatment mode of truck hours as a function of the weather variables presented above. To account for the potential delay between treatment decision and implementation, variables shifted back by 1 h and 2 h were also considered.

In this case study we considered two classification scenarios. In the first one, a classifier was trained to decide for each truck hour ($n = 8672$), whether it falls within a treatment period, and if yes, to predict the treatment mode. In the second scenario, only truck hours within treatment periods were considered ($n = 1405$), and the treatment mode was predicted.

In this exploratory analysis of winter maintenance activities, we used classification trees because they provide a simple means for modeling complex interactions between explanatory variables (17). This appears to be more appropriate in this context than the additive combination of variables by linear or logistic models. Classification trees are hierarchical sets of yes–no questions that are derived from a training data set by minimizing a loss function. This function may allocate different, user-defined costs to, for example, false-positive predictions (incorrect prediction of belonging to a treatment period), or the misclassification of a high treatment truck-hour as a low treatment hour. We use pruning based on fivefold crossvalidation to cut down the classification tree to a reasonable size and avoid overfitting the classifier to the data. While the tuning of these settings introduces some subjectivity, computational techniques for assessing the predictive performance of various classifiers in the presence of complex dependence structures

will be used in future studies (18,19). All analyses are conducted in the data analysis environment R (20) and its package “rpart” (21).

ILLUSTRATIVE RESULTS FOR MODELING TREATMENT PERIOD AND MODE

The classification tree generated by modeling the entire season is illustrated in Figure 2. The tree mostly uses weather observation variables (25 nodes or junctions) but also weather forecast variables (seven nodes), radar-derived variables (two nodes) and variables related to seasonal, diurnal, or truck-related influences on road maintenance activities (four nodes). Definitions of the explanatory variables are included in Table 2.

The classification tree for distinguishing among four treatment modes (“zero,” “low,” “medium,” or “high”) and nontreatment periods (“na”) illustrates only the first five levels of bifurcation. If a question is answered positively, the left branch is followed; otherwise, the right one. The label assigned to each terminal node identifies its predicted class; the corresponding numbers (a/b/c/d/e) indicate the number of truck hours: (a) nontreatment truck hours, (b) zero-treatment truck hours, (c) low-treatment truck hours, (d) medium-treatment hours, and (e) high-treatment hours.

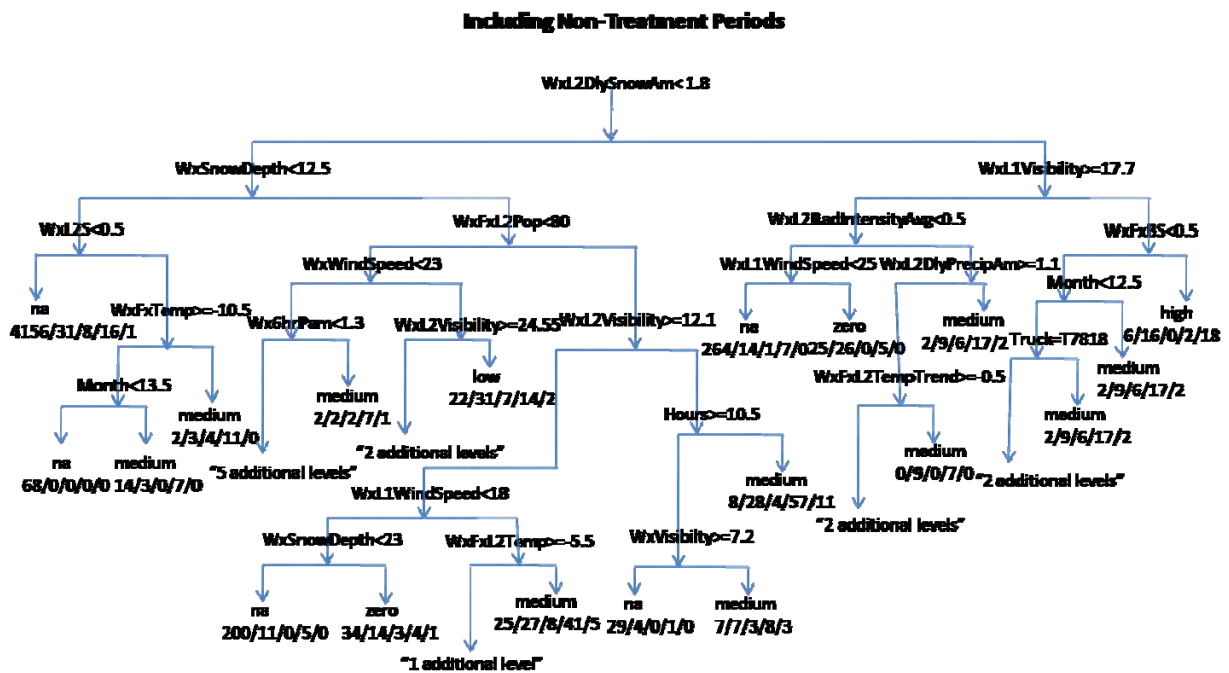

FIGURE 2 Classification tree for all hours in sample data set.

TABLE 2 Definitions of Explanatory Variables

Independent Variable	Valid Values	Data from Environment Canada and AMEC/MTO Weather conditions reported at beginning of the hour
WxVisibility	0–25	Visibility distance (km)
WxWindDir	0–360	Direction of wind (decimal degrees based on 16 cardinal points)
WxWindSpeed	0–100	Wind speed measured at 10m height (km/h)
WxTemp	–40 to 40	Dry bulb air temperature (°C)
WxDewpoint	–40 to 30	Dewpoint temperature (°C)
WxRH	10–100	Relative humidity (%)
WxSLP	95–107	Sea level air pressure (kPa)
WxCloud	0–10	Cloud amount where 0 clear and 10 is overcast (tenths)
WxR	0,1	Reported occurrence and intensity of rain: light (1), moderate (2), heavy (3)
WxRW	0,1	Reported occurrence and intensity of rain showers: light (1), moderate (2), heavy (3)
WxL	0,1	Reported occurrence and intensity of drizzle: light (1), moderate (2), heavy (3)
WxZR	0,1	Reported occurrence and intensity of freezing rain: light (1), moderate (2), heavy (3)
WxZL	0,1	Reported occurrence and intensity of freezing drizzle: light (1), moderate (2), heavy (3)
WxS	0,1	Reported occurrence and intensity of snow: light (1), moderate (2), heavy (3)
WxSG	0,1	Reported occurrence and intensity of snow grains: light (1), moderate (2), heavy (3)
WxIP	0,1	Reported occurrence and intensity of ice pellets: light (1), moderate (2), heavy (3)
WxSW	0,1	Reported occurrence and intensity of snow showers: light (1), moderate (2), heavy (3)
WxSP	0–3	Reported occurrence and intensity of snow pellets: light (1), moderate (2), heavy (3)
WxFog	0,1	Reported occurrence of fog
WxBs	0,1	Reported occurrence of blowing snow
Wx6hrPam	0–50	Accumulated liquid-equivalent precipitation over 6-h period in which hour occurs (mm)
WxDlyRainAm	0–100	Accumulated daily rainfall in which hour occurs (mm)
WxDlySnowAm	0–100	Accumulated daily snowfall in which hour occurs (cm)
WxDlyPrecipAm	0–100	Accumulated daily liquid-equivalent precipitation in which hour occurs (mm)
WxSnowDepth	0–100	Depth of snow on the ground measured in the morning (cm)
WxWsWatch	0,1	Winter storm watch in effect
WxWsWarn	0,1	Winter storm warning in effect
WxSnowWarn	0,1	Snowfall warning in effect

(continued on next page)

TABLE 2 (continued) Definitions of Explanatory Variables

WxZrWarn	0,1	Freezing rain warning in effect
WxFlashWarn	0,1	Flash freeze warning in effect
WxWsAdv	0,1	Advisory of potential for winter storm conditions in effect
WxSnowAdv	0,1	Advisory of potential for heavy snowfall, snowfall just below warning criteria, or changeover from rain to snow
WxZIAdv	0,1	Advisory of potential for freezing drizzle or rain below warning criteria
WxRadObs	0,1	Valid or invalid observation during event (assumed during nonevent periods)
WxRadPrecipAny	0,1	Identification of precipitation echoes on the image that may reach study region
WxRadPrecipStudy	0,1	Precipitation echoes observed in study region
WxRadNature	0–2	Morphology of precipitation echoes observed in study region (0 no echoes, 1 cellular/scattered, 2 solid–continuous)
WxRadCov	0–3	Precipitation echoes cover 0% (0), <25% (1), 25%–50% (2), or >50% (3) of the study region
WxRadIntensityAvg	0–4	Most common intensity of precipitation echoes observed in the study region. Precipitation echoes not observed in study area portion of image (0), 9–20db or 0.1–.3cm/h (1), 20–29db or 0.3–.75cm/h (2), 29–35db or 0.75–1.5cm/h (3), >=35db or >=1.5cm/h (4)
WxRadIntensityMax	0–10	Maximum intensity of precipitation echoes observed in the study region. Precipitation echoes not observed in study area portion of image (0), 9–20db or 0.1–.3cm/h (1), 20–25db or 0.3–.5cm/h (2), 25–29db or 0.5–.75cm/h (3), 29–32db or 0.75–1.0cm/h (4), 32–35db or 1.0–1.5cm/h (5), 35–38db or 1.5–2.0cm/h (6), 38–42db or 2–3cm/h (7), 42–45db or 3–4cm/h (8), 45–47db or 4–5cm/h (9), >=47db or >=5cm/h (10).
WxFxTonightLowtemp	–40 to 40	Low air temperature (°C) forecast for tonight (3:30pm forecast)
WxFxTonightTempTrend	–1,0,1	Air temperature (°C) trend (falling, nothing stated, rising) forecast for tonight (3:30 p.m. forecast)
WxFxTonightSnow	0,1	Forecast of flurries, snow showers or snow for tonight (3:30 p.m. forecast)
WxFxTonightRain	0,1	Forecast of drizzle, rain showers, or rain for tonight (3:30 p.m. forecast)
WxFxTonightMixed	0,1	Forecast of freezing drizzle, freezing rain, or ice pellets for tonight (3:30 p.m. forecast)
WxFxTonightSnowAmLow	0–40	Forecast minimum amount of solid precipitation (cm) for tonight (3:30 p.m. forecast)
WxFxTonightSnowAmHigh	0–40	Forecast maximum amount of solid precipitation (cm) for tonight (3:30pm forecast)

(continued on next page)

TABLE 2 (continued) **Definitions of Explanatory Variables**

WxFxTonightPop	0–100	Forecast probability of precipitation for tonight (3:30 p.m. forecast). Maximum if different probabilities issued for sub-periods (e.g., morning–afternoon) or forms of precipitation (e.g., rain–snow)
WxFxTonightBS	0,1	Forecast of blowing snow for tonight (3:30 p.m. forecast)
WxFxTomorrowHightemp	–40 to 40	High air temperature (°C) forecast for tomorrow (3:30 p.m. forecast)
WxFxTomorrowTempTrend	–1,0,1	Air temperature (°C) trend (falling, nothing stated, rising) forecast for tomorrow (3:30 p.m. forecast)
WxFxTomorrowSnow	0,1	Forecast of flurries, snow showers or snow for tomorrow (3:30pm forecast)
WxFxTomorrowRain	0,1	Forecast of drizzle, rain showers, or rain for tomorrow (3:30 p.m. forecast)
WxFxTomorrowMixed	0,1	Forecast of freezing drizzle, freezing rain, or ice pellets for tomorrow (3:30 p.m. forecast)
WxFxTomorrowSnowAmLow	0–40	Forecast minimum amount of solid precipitation (cm) for tomorrow (3:30 p.m. forecast)
WxFxTomorrowSnowAmHigh	0–40	Forecast maximum amount of solid precipitation (cm) for tomorrow (3:30 p.m. forecast)
WxFxTomorrowPop	0,1	Forecast probability of precipitation for tomorrow (3:30 p.m. forecast). Maximum if different probabilities issued for subperiods (e.g., morning–afternoon) or forms of precipitation (e.g., rain–snow)
WxFxTomorrowBS	0,1	Forecast of blowing snow for tomorrow (3:30 p.m. forecast)
WxRoadEr16Tair	–40 to 40	Air temperature (°C) at MTO RWIS ER-16 recorded closest to the top of the hour
WxRoadEr16Tdew	–40 to 30	Dewpoint temperature (°C) at MTO RWIS ER-16 recorded closest to the top of the hour
WxRoadEr16Psituation	1–15	Precipitation situation reported at MTO RWIS ER-16 recorded closest to the top of the hour: other (1), unknown (2), no precip (3), unident slight (4), unident moderate (5), unident heavy (6), snow slight (7), snow moderate (8), snow heavy (9), rain slight (10), rain moderate (11), rain heavy (12), freezing rain slight (13), freezing rain moderate (14), freezing rain heavy (15)
WxRoadEr16Tsurface	–40 to 70	Pavement surface temperature (°C) at MTO RWIS ER-16 recorded closest to the top of the hour
WxRoadEr16SurfaceStatus	1–14	Status (condition) of road surface recorded closest to the top of the hour: other (1), error (2), dry (3), trace (4), wet (5), chemical wet (6), ice warning (7), ice watch (8), snow warning (9), snow watch (10), absorption (11), dew (12), frost (13), absorption at dew 7 (14)

The first decision criterion used by the classifier indicates that a daily snow accumulation (measured two hours earlier) of less than 1.8 cm tends to be associated with a lower treatment mode or no treatment. In these truck hours with low daily snow accumulation, the largest predicted nontreatment subset is identified as having a snow depth on the ground of up to 12 cm and no snowfall being reported (2 h earlier). This subset consists of 4,212 predicted nontreatment hours, 25 of which (0.6%) had in reality received at least low treatment.

Another important nontreatment group with low daily snow accumulation corresponds to a snow depth on the ground of more than 12 cm, a probability of precipitation forecast (2 h earlier) of less than 80%, wind speed <23 km/h, and an accumulated liquid-equivalent precipitation over a 6-h period of less than 1.3 mm. Further conditions on daily snow accumulation and predicted air temperature that are cut off in [Figure 2](#) lead to a subset of 1,324 truck hours predicted as nontreatment hours. Of these, 15 (or 1.1%) had in reality received at least low treatment.

In the prediction of nonzero treatment nodes, only a small set of 42 truck hours was classified as high-treatment mode (observed: 82). This set corresponds to a daily snow accumulation of at least 1.8 cm, visibility (1 h earlier) of less than 17.7 km, and a weather forecast indicating blowing snow (Node B in [Figure 2](#)). However, of these 42 predicted high-treatment hours, only 18 (or 42.9%) were correctly classified, whereas 22 (or 52.4%) in reality did not receive any treatment. The poor predictive performance for the high-treatment mode is attributed to the small size of this class in the training data set.

Of the remaining 726 truck hours with daily snow accumulation of at least 1.8 cm and visibility <17.7 km but without expected blowing snow (Node Group C in [Figure 2](#)), most (616 or 84.8%) were predicted as having medium-level treatment, and the remaining 15.2% as falling outside the treatment period. All of these 110 predicted nontreatment hours were correct predictions. Of the predicted medium-treatment hours in this set of nodes, 322 (or 52.3%) were correct predictions, while another 76 (or 12.3%) were wrong by only one treatment level (i.e., in reality either low or high treatment). The significant confounding of zero-treatment hours being predicted as medium-level treatment (overall 13.5% of the predicted medium-level hours and 27.6% in Subtree C) is related to the difficulty of modeling the rhythm of treatment within a storm event.

The predictive performance of the classification tree measured on the training data set is presented in [Table 3](#). The numbers reported may be biased because they were not obtained on an independent test data set; however it is expected that overfitting was avoided by using the pruning procedure. Pruning cuts off higher-order bifurcations that do not improve the predictive accuracy assessed on test data sets by an internal crossvalidation.

The overall accuracy of this five-class classifier is 79.4%, but it rises to 87.4% in the dichotomous discrimination of treatment and nontreatment periods (class “n.a.” versus all others). On the training data set, 82.3% of the truck hours falling within a treatment period were correctly predicted as treatment hours, and 95.9% of the nontreatment hours were correctly classified as such.

TABLE 3 Confusion Matrix of the Classification Tree, Entire Season

Observed Mode	Predicted Mode					Sum	Correct
	N.A.	Zero	Low	Medium	High		
N.A.: outside treatment period	6,970	130	39	122	6	7,267	95.9
Zero-inside treatment period	1,771	82	55	279	16	609	13.5
Low-inside treatment period	18	10	8	76	0	112	7.1
Medium-inside treatment period	50	19	27	505	2	603	83.7
High-inside treatment period	3	3	3	54	18	81	22.2
Sum	7,218	244	132	1,036	42	8,672	
Correct	96.6	33.6	20.5	48.7	42.9		79.4

More misclassification occurs at the zero-, low-, medium-, and high-level treatments, partly because a lower cost was assigned to these types of misclassification. Of the 1,036 predicted medium-treatment hours, 279 (or 26.9%) actually received zero treatment, while only 130 (or 12.5%) were in reality in the low- or high-treatment classes. While these are smaller subsets of the training sample, the misclassification of medium-treatment hours as low or high was also assigned a smaller cost than their misclassification as zero in training the classifier.

Our interpretation of these findings is that a substantial number of the zero-treatment hours that were predicted as low-, medium-, or high-level treatment, fall within weather conditions that suggest nonzero treatment, but no treatment was required because it had already been performed in previous hours. This interpretation is based on the observation that these “false-medium” zero-treatment hours frequently fall within breaks of several (up to 5) hours between blocks of medium or even high-treatment levels. These management decisions taken by experts are difficult to model, but it may be possible to adjust the cost matrix to improve it.

ILLUSTRATIVE RESULTS FOR MODELING TREATMENT MODE WITHIN TREATMENT PERIOD

A second model was developed, this time using only the 1,405 h that were within treatment periods. [Figure 3](#) shows the associated classification tree, and [Table 4](#) displays the confusion matrix calculated on the training data set. The tree uses a mix of weather observation variables (17 nodes), road weather variables (six nodes), radar-derived variables (four nodes), and weather forecast variables (two nodes), but it also includes seasonal, diurnal, and truck-related influences (one node each). Compared with the tree presented in [Figure 2](#), which includes the discrimination of nontreatment periods, the present tree makes less use of weather forecast variables, but it incorporates a significant number of road weather observation variables. This suggests that road weather observations are important predictors of winter road management decisions when treatment takes place, while they do not provide decisive information in defining treatment periods. The overall accuracy achieved by this tree on the training data set is 66.2%; however, it rises to 85.1% if a misclassification by one treatment level (e.g., low is predicted as medium) is deemed acceptable.

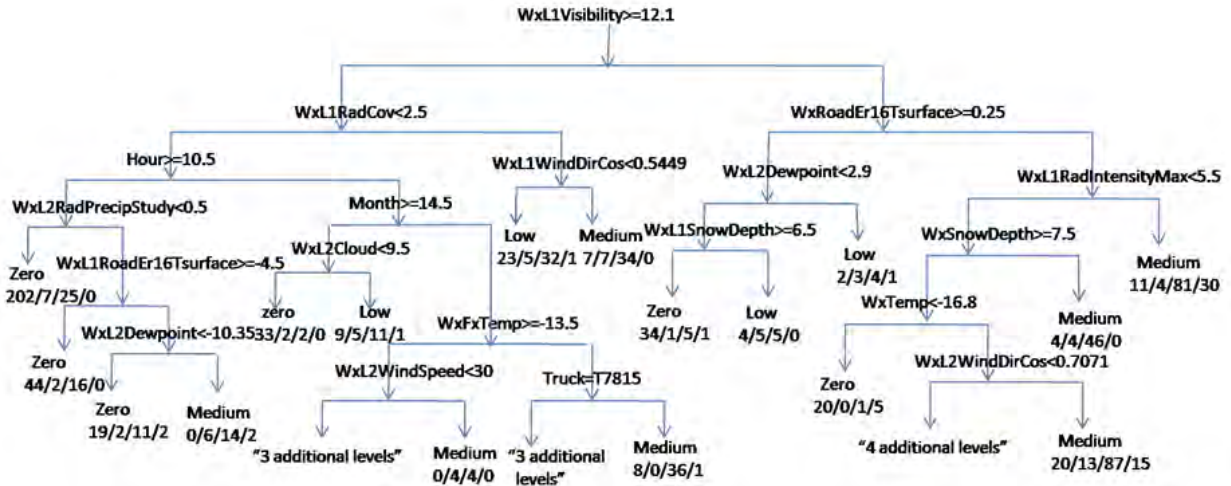

FIGURE 3 Classification tree for hours in treatment periods.

An important zero-treatment group ($n = 234$) identified by the classification tree is characterized by good visibility (≥ 12.1 km), no radar precipitation echoes observed (2 h earlier) in the study region, and an hour of the day after 10 a.m. Three relatively large and pure terminal nodes are predicted as medium-level treatment, all of which require a visibility (1 h earlier) of <12.1 km and a pavement surface temperature below $+0.25^\circ\text{C}$ as preconditions. The first “medium” subset ($n = 126$) further requires a maximum intensity of precipitation echoes observed (1 h earlier) in the study region of at least 38 db or 2 cm/h. The second group ($n = 54$) has a lower maximum radar intensity, and a snow depth on the ground of less than 7.5 cm; and the third “medium” group ($n = 135$) has a greater snow depth, and in addition an observed air temperature of at least -16.8°C and a northerly wind direction (cosine of wind direction ≥ 0.71). (Truck hours not falling within these three groups were classified as either zero or medium-level treatment hours depending on a series of additional criteria.)

TABLE 4 Confusion Matrix of the Classification Tree, Treatment Periods Only

Observed Mode	Predicted Mode				Sum	Correct
	Zero	Low	Medium	High		
Zero-inside treatment period	484	52	71	2	609	79.5
Low-inside treatment period	28	25	57	2	112	22.3
Medium-inside treatment period	118	68	415	2	603	68.8
High-inside treatment period	11	5	59	6	81	7.4
Sum	641	150	602	12	1,405	
Correct	75.5	16.7	68.9	50		66.2

CONCLUSION

Considerable progress has been made in developing databases and models related to winter maintenance decisions and outcomes. Many of the earlier models had a number of drawbacks, some of which were related to the modeling approach. The current paper presents the preliminary results of a new method of predicting winter maintenance activities at the truck-hour level based on forecast and observed weather conditions. The results, which are only exploratory, are promising both in terms of the accuracy of predictions and the ability of this inductive approach to identify key explanatory variables and related threshold values that affect the probability of different treatment options. Ongoing work is examining the application of this technique to other maintenance activities (e.g., one-lane versus two-lane treatment). New challenges will undoubtedly emerge when we use new data and apply the approach to different regions or seasons. However, the value of the approach is that it takes a fairly complex decision process and simplifies it in a way consistent with our a priori thinking. Also, classification trees are the basis for more advanced machine-learning techniques such as bagging or bundling classifiers. These and other techniques will be compared in future papers.

REFERENCES

1. Jones, B. Road Maintenance Costs in Canada in Winter. *Weather and Transportation in Canada* (J. Andrey and C. Knapper, eds.), Department of Geography Publication Series, No. 55, University of Waterloo, Canada, 2003, pp.121–142.
2. *Salt Management Guide*. Transportation Association of Canada, Ottawa, Canada, 1999.
3. Mahoney, W. P. III, B. Bernstein, J. Wolff, J. Linden, W. L. Myers, R. G. Hallowell, J. Cowie, A. D. Stern, G. Koenig, G. Phetteplace, P. Schultz, P. A. Pisano, and D. Burkheimer. FHWA's Maintenance Decision Support System Pilot. In *Transportation Research Record: Journal of the Transportation Research Board, No. 1911*, Transportation Research Board of the National Academies, Washington, D.C., 2005, pp. 133–142.
4. Pisano, P. A., A. D. Stern, W. P. Mahoney III, and D. Burkheimer. Winter Weather: Information, Models and Data Quality. *Transportation Research Circular E-C063: 6th International Symposium on Snow Removal and Ice Control Technology*, Transportation Research Board of the National Academies, Washington, D.C., 2004, pp. 3-10.
5. Thornes, J. E. Cost-Effective Snow and Ice Control for the 1990s. In *Transportation Research Record 1387*, TRB, National Research Council, Washington, D.C., 1993, pp. 185–190.
6. Hothorn, T., and B. Lausen. Bundling Classifiers by Bagging Trees. *Computational Statistics and Data Analysis*, Vol. 49, 2005, pp. 1068–1078.
7. Hulme, M. A New Winter Index and Geographical Variations in Winter Weather. *Journal of Meteorology*, Vol. 7, 1982, pp. 294–300.
8. Cornford, D., and J. E. Thornes. A Comparison Between Special Winter Indices and Expenditure on Winter Road Maintenance in Scotland. *International Journal of Climatology*, Vol. 16, 1996, pp. 339–357.
9. Andrey, J., J. Li, and B. Mill. A Winter Index for Benchmarking Winter Road Maintenance Operations on Ontario Highways. Presented at 80th Annual Meeting of the Transportation Research Board, Washington, D.C., 2001.
10. Decker, R., J. L. Bignell, C. M. Lambertsen, and K. L. Porter. Measuring Efficiency of Winter Maintenance Practices. In *Transportation Research Record: Journal of the Transportation Research Board, No. 1741*, TRB, National Research Council, Washington, D.C., 2001, pp. 167–169.
11. Venalainen, A. Estimation of Road Salt Use Based on Winter Air Temperature. *Meteorological Applications*, Vol. 8, 2001, pp. 333–338.

12. Venalainen, A., and K. Markku. Estimation of WRM Costs Using Climate Sata. *Meteorological Applications*, Vol. 10, 2003, pp. 69–73.
13. Hadayeghi, A. Development of a Winter Severity Index for Salt Management in Canada. Presented at 86th Annual Meeting of the Transportation Research Board, Washington, D.C., 2007.
14. Carmichael, C., W. Gallus, B. Temeyer, and M. Bryden. A Winter Weather Index for Estimating Winter Roadway Maintenance Costs in the Midwest. *Journal of Applied Meteorology*, Vol. 43, 2004, pp. 1783–1790.
15. Nixon, W. A., and L. Qiu. Developing a Storm Severity Index. Presented at 84th Annual Meeting of the Transportation Research Board, Washington, D.C., 2005.
16. Boselly, S., J. Thornes, C. Ulberg, and D. Ernest. *Road Weather Information Systems. Vol. 1. Research Report*, 1993.
17. Breiman, L., J. H. Friedman, R. A. Olshen, and C. J. Stone. *Classification and Regression Trees*. Chapman & Hall / CRC Press, New York, 1984.
18. Brenning, A. Spatial Prediction Models for Landslide Hazards: Review, Comparison and Evaluation. *Natural Hazards and Earth System Sciences*, Vol. 5, 2005, pp. 853–862.
19. Brenning, A., K. Kaden, and S. Itzerott. Comparing Classifiers for Crop Identification Based on Multitemporal Landsat TM/ETM Data. In *Proc., Second Workshop of the EARSeL Special Interest Group on Remote Sensing of Land Use and Land Cover* (M. Braun, ed.), Bonn, Germany, 2006, pp. 64–71.
20. Ihaka, R., and R. Gentleman. R: A Language for Data Analysis and Graphics. *Journal of Computational and Graphical Statistics*, Vol. 5, 1996, pp. 299–314.
21. Therneau, T. M., and B. Atkinson. *rpart: Recursive Partitioning. R package version 3.1-38*, R port by B. Ripley. Available online via the Comprehensive R Archive Network (CRAN), <http://www.cran.r-project.org/>. Accessed November 10, 2007.

RELATIONSHIPS BETWEEN WINTER SERVICE AND WEATHER

The Possibility of Implementing the Management Cycle of Winter Maintenance by Performance Measurement

MOTOKI ASANO

ROBERTO A. TOKUNAGA

Civil Engineering Research Institute for Cold Region

The studded-tire regulation prevented studded tire dust from being released into the environment; consequently, this leads to air quality improvement. On the other hand, the most important factor that determines vehicular movement on icy roadways is the frictional force between winter tire and road surface, and it greatly affects travel performance and safety on snowy and icy roadways. Putting conclusive restrictions on winter travel, the regulation leads to some negative effects, such as increased winter accidents, worsened winter travel, increased anti-icing chemical usage, and increased winter maintenance cost. When one evaluates the studded-tire regulation regarded as one policy, the regulation guides the negative effects of winter travel and winter road maintenance while achieving its intended goal, which controls dust pollution caused by studded tires. At the time of the legislative vote on the regulation, the supplementary decision indicated the need for a review of the state of the measures after the regulation was implemented. Moreover, with enforcement of the Policy Evaluation Act, road authorities have performed their road management by setting up targets in number. This study proposes the management of winter road maintenance with the logic model that recognizes travel pattern, traffic accidents, and compliant numbers as the final outcome of the policy while establishing the friction coefficient of winter road surfaces, which is the direct effect of winter road maintenance, as the policy's intermediate outcome. The study also attempts to use this model to see how it works.

Environmental pollution caused by studded tire dust became a serious social concern in Japan since the late 1970s. This led to the enactment of the Studded Tire Regulation Law of 1990, which prohibited the use of studded tires. On the other hand, the most important factor that determines vehicular movement on icy roadways is the frictional force (road surface grip) between winter tire and road surface. Indeed, the road surface grip condition greatly affects traffic pattern and safety on snowy and icy roadways. The regulation, therefore, might put conclusive restrictions on winter travel. The studded tire regulation is generally accepted by the public because it achieved preventing studded tire dust; on the other hand, the regulation leads to some negative effects, such as increased winter accidents, worsened winter travel, increased deicing chemical usage, and increased winter maintenance cost.

EVALUATION OF STUDED-TIRE REGULATION

The most important factor that determines vehicular movement on winter roadways is the friction coefficient between winter tires and the road surface. The friction significantly affects travel performance and safety on snowy and icy roadways. Although winter travel is significantly affected by a kind of winter tire, the studded tire regulation determined what kind of

tire should be used. Otherwise, it can be said that the regulation is the policy with the critical impact on winter travel.

Figure 1 shows the trend of dustfall, suspended particulate matter (SPM), and vehicles with studded tires in the Sapporo, Japan, area as well as situation photographs before and after the regulation was implemented. The proportion of vehicles using studded tires had begun to decrease around 1988 before the regulation was enacted in 1990 due to adoption of ordinances and self-control for using them. With enforcement of the regulation in winter 1992, the proportion in the areas designated to restrict their use (restricted area) was approximately 2% to 3%. At the same time, it is recognized that the dustfall and SPM amount positively declined. Especially, the 1994 dustfall amount was under 20 t/km²/month, which is the standard for the restricted area. Although SPM has been entirely decreased since the implementation, it varies with weather change every year. Indeed, it increased due to yellow sand dust, known as Asian dust, transported from China with harmful effects on the Asian region in 2000.

On the other hand, since the 1992–1993 winter season when the proportion of vehicles using studded tires was 2% to 3%, nonstudded winter tires as substitutes for them made roadway surfaces extremely slippery, which could not be expected before the implementation (see Figure 2). Therefore, as shown in Figure 3, winter accidents mainly caused by slippery roadways doubled in 5 years after the 1989–1990 winter season. In addition to winter accidents, winter travel performance took a turn for the worse. Indeed, in the Sapporo area, the average speed on arterials got worse by about 15% before and after the implementation (see Figure 4).

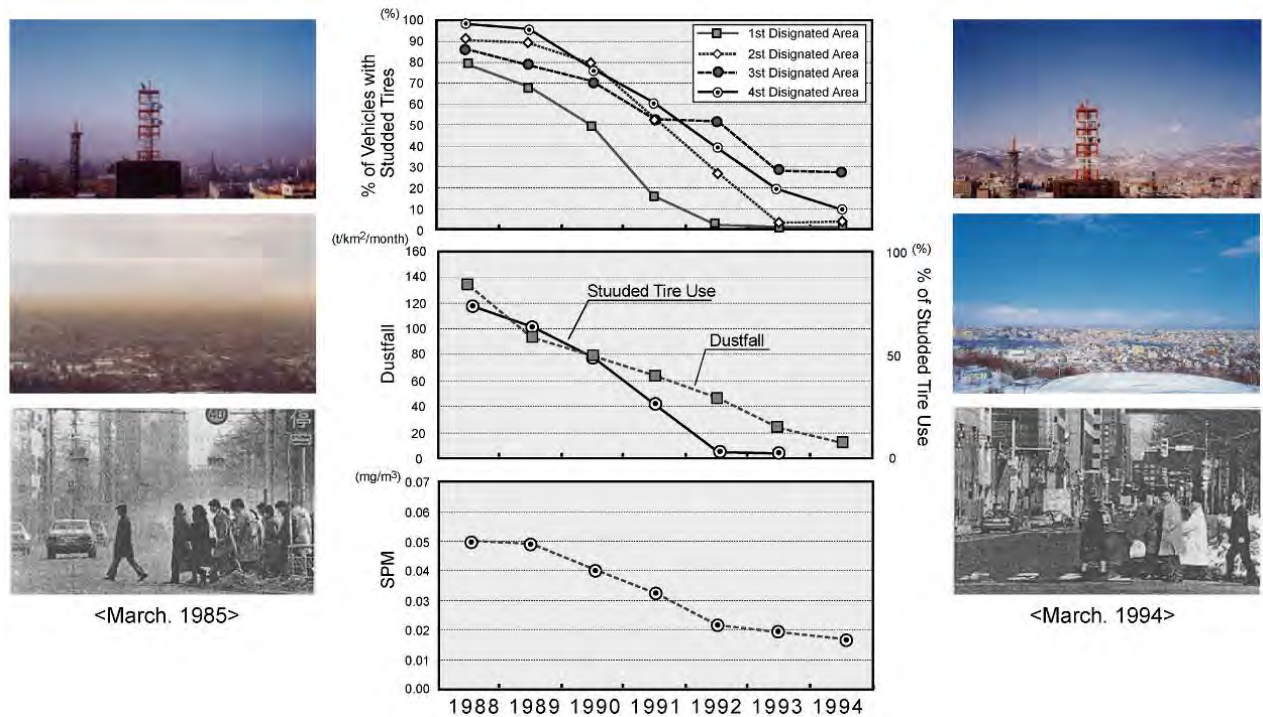

FIGURE 1 Effect of the studded tire regulation, Sapporo area.



FIGURE 2 Sapporo's extremely slippery surface in winter.

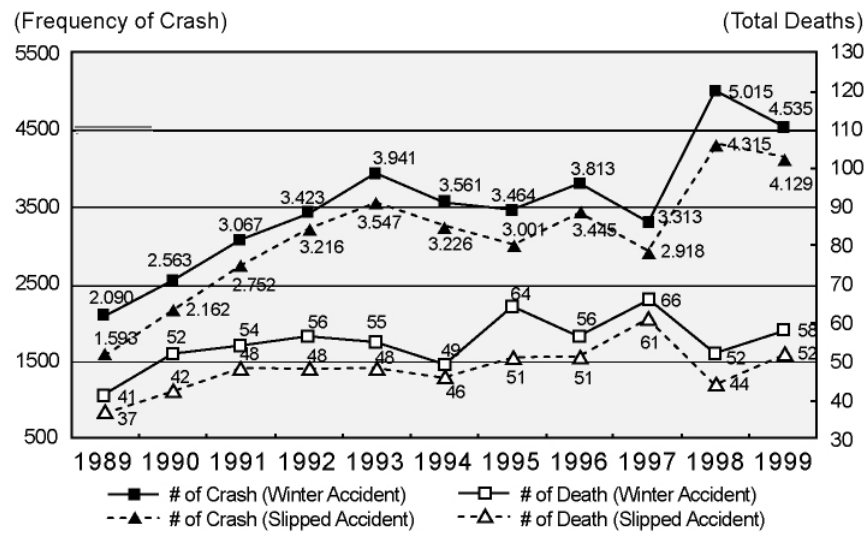

FIGURE 3 Winter accidents in Hokkaido.

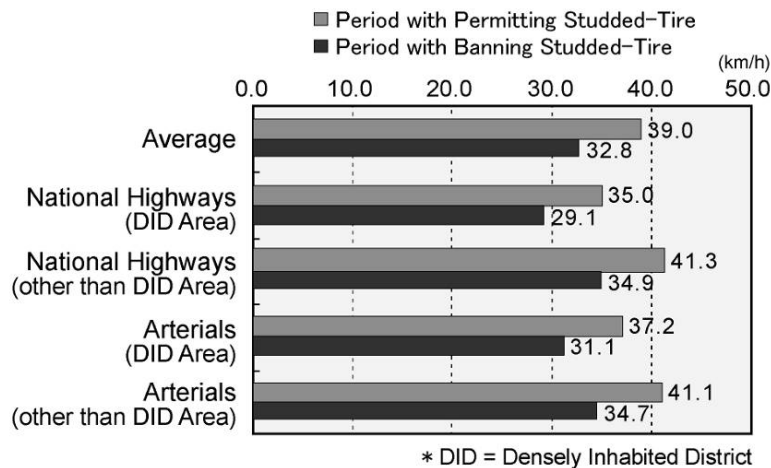

FIGURE 4 Travel speed before and after the implementation in Sapporo.

The regulation negatively affects not only vehicular mobility but also pedestrian mobility. With the regulation comes potential for slippery pedestrian crossings. The number of pedestrians who are taken in an ambulance shows a tendency to significantly increase, as shown in Figure 5. Consequently, as road authorities are strongly required to make travel safer and more reliable, the amount of anti-icing chemicals and abrasives, which were hardly distributed before the regulation was implemented in 1990, tends to increase from year to year (see Figure 6). Otherwise, as shown in Figure 7, the cost for snow and ice control operations including various treatment activities has increased significantly.

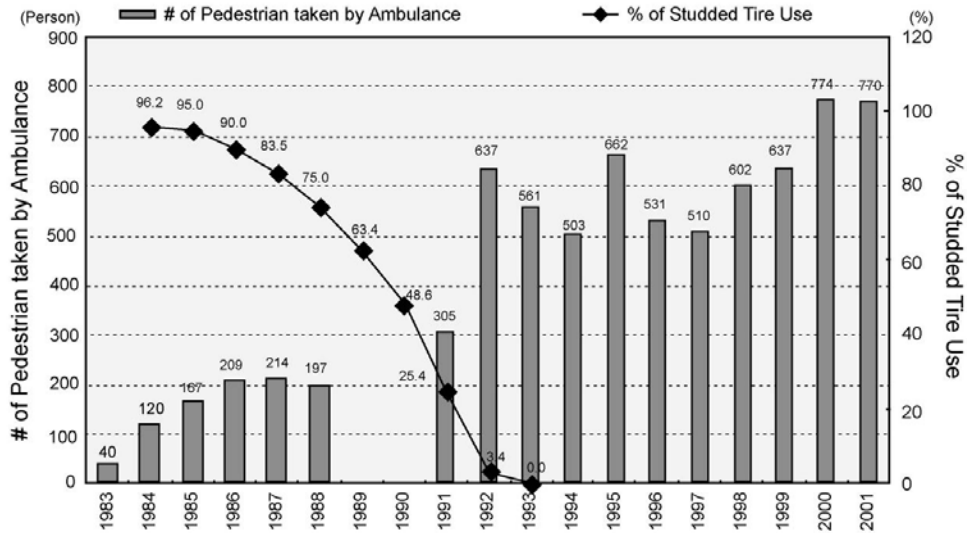

FIGURE 5 Number of pedestrians taken in ambulance during winter: Sapporo.

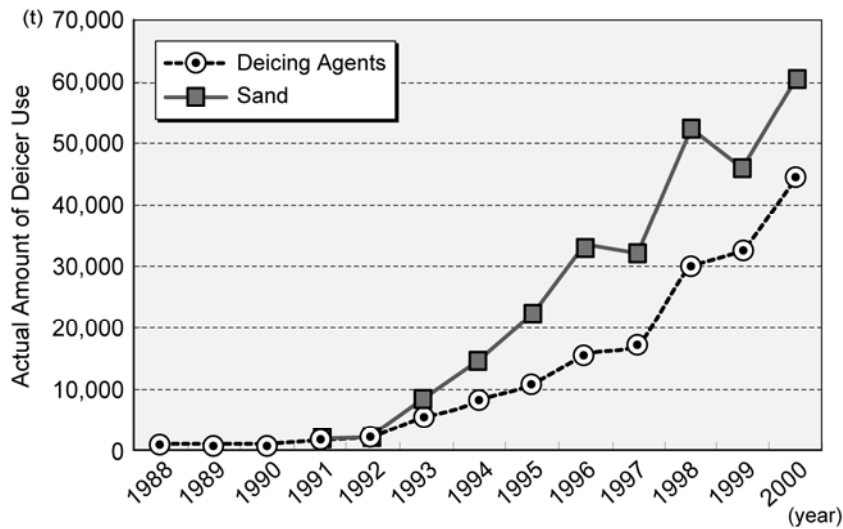

FIGURE 6 Amount of anti-icing chemical use on Hokkaido's national highways.

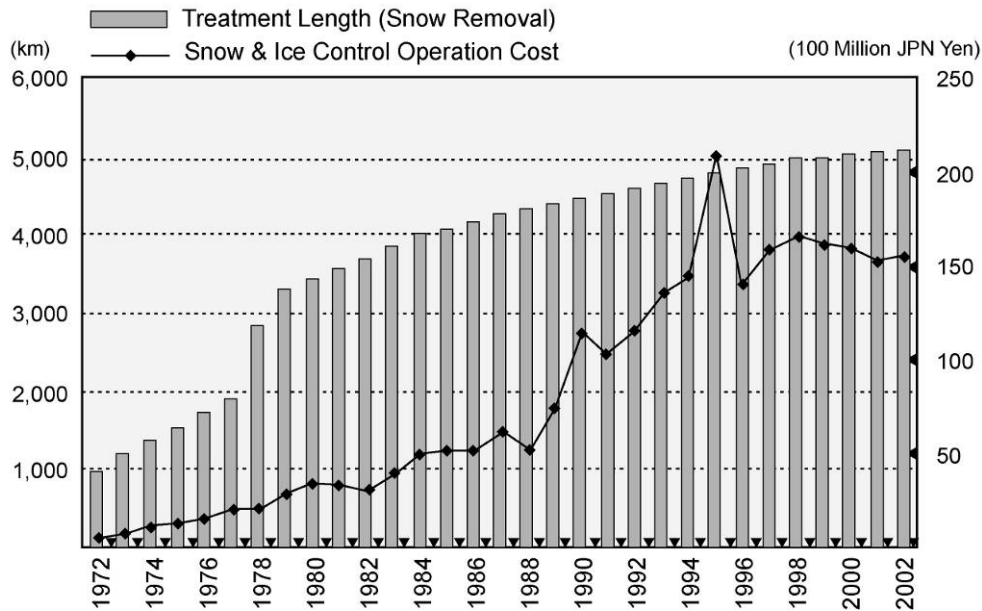

FIGURE 7 Sapporo's snow and ice control operation costs.

Furthermore, at the time of the legislative vote on the studded tire regulation, the following articles were included in the supplementary decision:

- Take necessary action for research and development of alternative tires.
- Consider that road administrator's effort, including snow and ice control operation, is not excessively heavy.
- Prevent secondary pollution.
- Take necessary action toward realization of a nonstudded tire society by reviewing the state of the measure against studded tire dust, taking into consideration designation area, dust situation, and alternative tire development.

These might require strategically managing winter road maintenance, taking into consideration the situation after the studded tire regulation was implemented, as described here.

MANAGEMENT OF WINTER MAINTENANCE

Road authorities in northern countries are continually looking for better ways to manage winter road maintenance. For instance, as shown in Figure 8, Sweden has developed a unique winter road management model called the Winter Model. This model was developed to evaluate winter road maintenance, especially road surface, with synthetic optimization by converting any impacts to monetary value. Those impacts include economic and environmental impacts in addition to items that directly influence road users, such as travel performance and traffic safety.

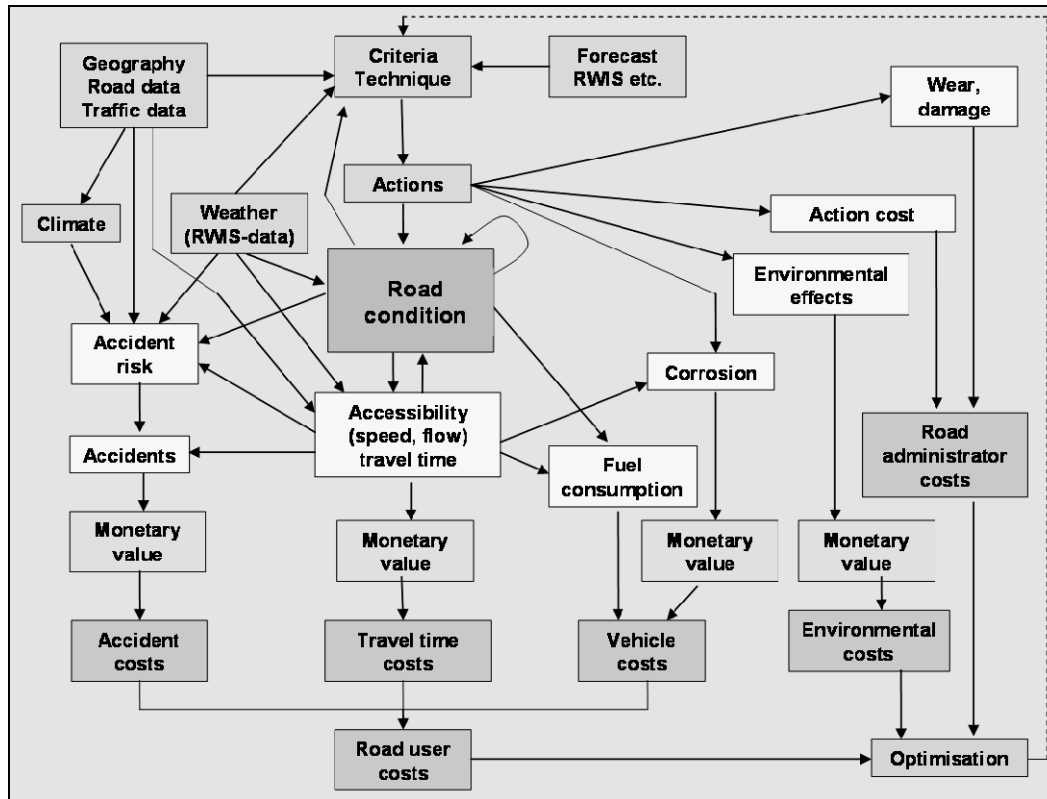

FIGURE 8 Sweden's Winter Model.

Another unique example is one in the province of Alberta, Canada, which conducts performance measurement as asset management. However, performance evaluation suitable to winter road management has not yet been performed. The Alberta case measures the application amount of anti-icing materials as input and the frequency of snow removal as output, but it does not measure the effect of winter road management. Alternatively, it conducted the project on the performance measurement of winter management through the regional highway network.

In general, the invested resources as input involve monetary and human resources and anti-icing application amount, and products including treatment length and amount of anti-icing operation can be considered as output. Then, the outcome can be the impact byproducts, and those are reduction of access control points and winter accidents. The authority in Alberta collected data showing traffic volume and travel speed from the automatic vehicle meter, and surface condition data based on the road report by the Alberta Automobile Association. Using these data, the performance measurement of winter road management was experimentally conducted. Consequently, the study in Alberta shows that performance measurement could evaluate mobility and reliability from the relationship between snowfall and traffic volume or travel speed. Moreover, the study shows the importance of benchmark-based evaluation in order to conduct performance measurement of the road's current factors.

On one hand, in Japan, the Ministry of Land, Infrastructure, and Transport has promoted policy evaluation by framing management cycle of policy with carrying out three evaluations; the policy assessment, policy checkup, and policy review. Especially in road administration, a new administrative management framework, called road administration management, was

introduced in order to promote more effective road administration from the public viewpoint. To be concrete, a numerical target is set up in advance (plan), necessary policies and programs are implemented (do), and evaluation of their achievements (check) is reflected in the following administrative management (action). Therefore, it is meaningful work to study such a management approach in winter road maintenance.

ACHIEVEMENTS OF WINTER ROAD MAINTENANCE

It is important to discuss what the outcome of winter road maintenance is. For instance, Canada adopts the reduction of the access control points and winter accidents as the outcome. In addition to these indexes, outcome might include winter travel performance (e.g., travel speed, traffic capacity, traffic congestion time, congestion length) and road users' satisfaction and reliability. These are considered to be the final outcome as an effect of winter road maintenance. However, these indexes are affected by changeable factors with time such as traffic demand, weather condition, and traffic management, including signal control. Accordingly, the indexes are influenced by external factors other than winter road maintenance itself, such as snow removal and other snow and ice control operations. The determination of such final outcomes needs to be completed through the discussion between various stakeholders at the time of logic model development.

For this reason, it needs to specify the outcome not affected by the external factors. This study is interested in friction resistance values, which is a direct result of snow and ice control operations such as snow removal and anti-icing treatment. Conventionally, the bus-type locked-wheel friction tester, as shown in [Figure 9](#), measures the friction coefficient on roadways, but it is limited to recording data at specific points, thereby making it difficult to determine the change of friction resistance on a route as a whole. In the 2006–2007 winter season, the research group introduced the continuous friction tester, which can determine the surface condition of an entire route by measuring friction resistance continuously (see [Figures 9 and 10](#)). This study explored the logic model, which applies continuous friction values measured as a direct outcome of winter road maintenance, while conducting a preliminary study of the model route with this model.

PERFORMANCE MEASUREMENT LOGIC MODEL OF WINTER MAINTENANCE

[Figure 11](#) shows the proposed logic model for performance measurement of winter road maintenance. In this model, “input” and “activity” include budget, human resource, and technology concerning winter maintenance, and it selects frequency of anti-icing activity and anti-icing agents application volume as “output.” Furthermore, friction resistance value on the roadway is provided as “intermediate outcome” while offering winter traffic performance, traffic accident, and customer satisfaction are “final outcome.” In the 2006–2007 winter season, the preliminary case study using this model was conducted on a specific route (see [Figure 12](#)).

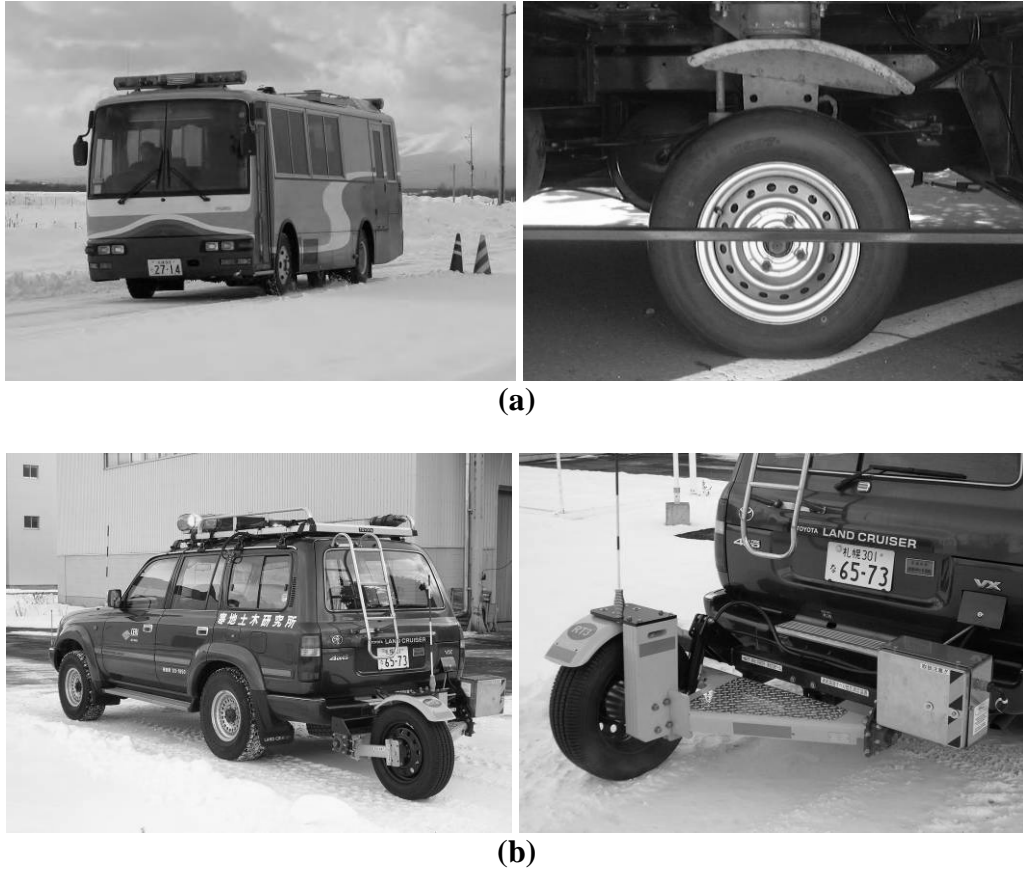

FIGURE 9 (a) Locked-wheel friction tester and (b) continuous friction tester.

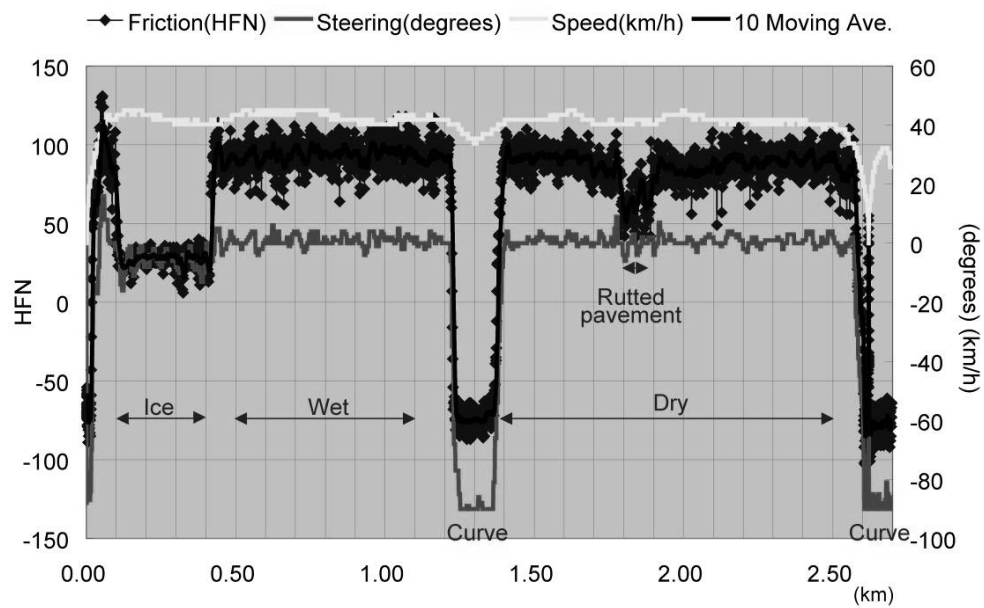

FIGURE 10 Example of measured data (continuous friction tester).

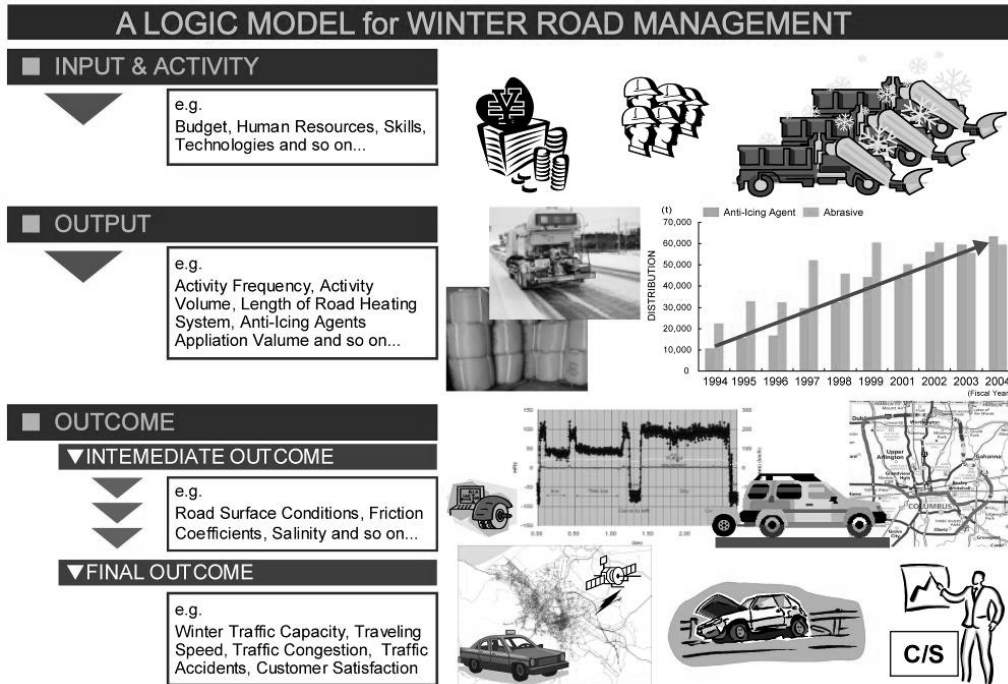

FIGURE 11 Logic model for the performance measurement of winter road management.



FIGURE 12 Case study route: National Highway Route 230, Sapporo.

In creating the logic model, it is necessary to specify the policy's goal and objective, and this study set these goals and objectives as follows:

- Goal: To enhance road users' satisfaction by providing safety, reliability, and mobility of winter travel through winter road maintenance.
- Objective 1: Ensure friction resistance value of 50 or more on snowy and icy roadways.
- Objective 2: Decrease winter accidents ratio below 5 cases/100 million vehicle kilometers, which is the average of the past 5 years.
- Objective 3: Ensure travel speed of 20 km/h or more, as is in the Tokyo metropolitan area, in morning peak hour.

The study obtained the number of snow removal stations, number of anti-icing vehicles, and operational cost of each vehicle as "input" data. The study also obtained the frequency of anti-icing activity as "output" data, friction resistance value as "intermediate outcome" data, and travel speed, winter accident ratio, and customer satisfaction as "final outcome" data. Further, in this preliminary study, customer satisfaction is assumed as the number of complaints and requests from road users about winter road maintenance (see [Figure 13](#)).

VIEWPOINT AND ISSUE OF EACH INDEX

Viewpoint of Availability Evaluation

According to the policy evaluation process, policy evaluation focuses on the necessary viewpoint depending on necessity, efficiency, availability, and other characteristics of the policy concerned. The final outcome, for instance, winter travel performance, traffic accident, and customer satisfaction in this study, is an index showing availability or necessity based on this viewpoint. However, as mentioned before, it is influenced by external factors other than winter road maintenance itself, and it is hard to develop an index by which these are evaluated directly.

On the other hand, the intermediate outcome, friction resistance value in this case, shows intermediately the availability of winter road maintenance. Unlike visual evaluation of winter road surface conditions, which can be easily affected by experience and visibility conditions, friction resistance value is able to identify surface condition objectively and quantitatively. Therefore, when evaluating the availability of winter road maintenance, it is an excellent index in fairness, reliability, and validity. The function left is to set up an appropriate level for the index. Therefore, it is necessary to define a relationship with the final outcome.

Viewpoint of Efficiency Evaluation

From a viewpoint of efficiency, one evaluates the ratio of inputs and activities (budget, staff, technology) to intermediate and final outcomes, and the ratio of output (ant-icing distributing result) to intermediate and final outcomes. Meanwhile, since the final outcome is affected by the external factors in this case, it cannot be recognized as an effective index. Therefore, also in the viewpoint of efficiency evaluation, friction resistance value as the intermediate outcome works well as the index. The viewpoint of the evaluation serves to increase the efficiency of the input for

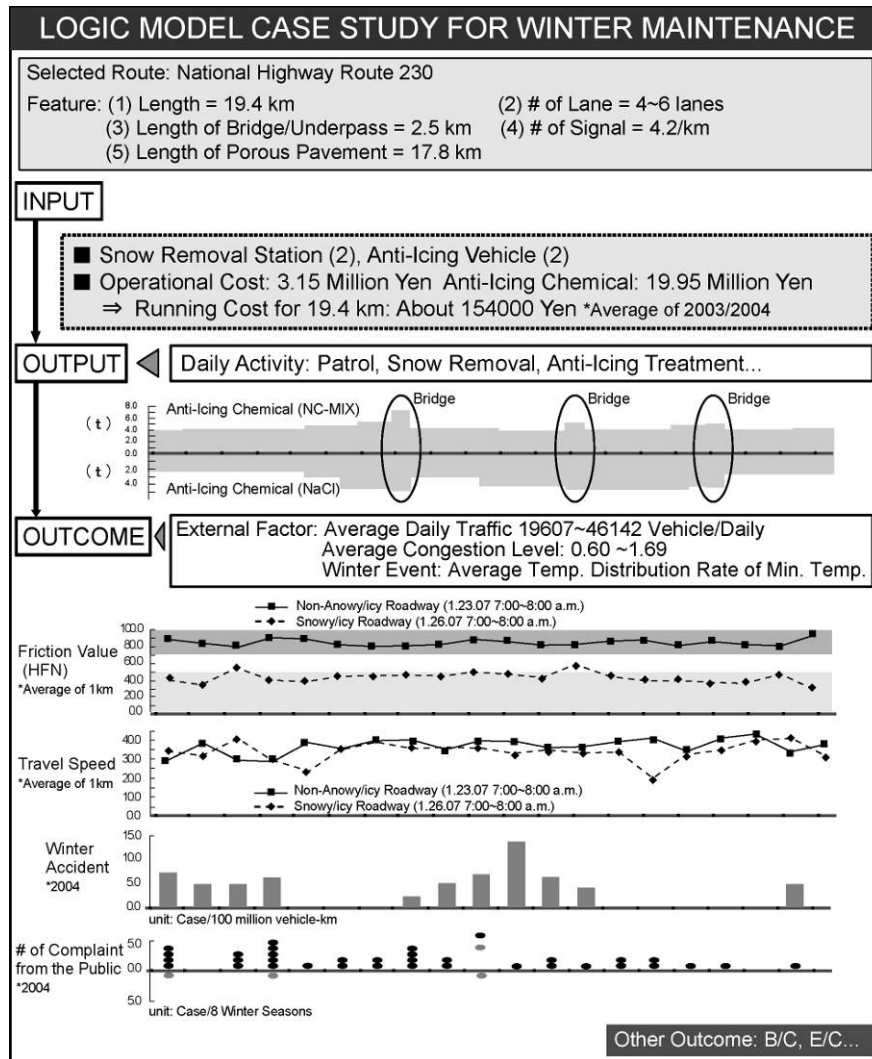

FIGURE 13 Example of application of the logic model to the case study route.

determining appropriate intermediate outcome (friction resistance value) and activities (budget, staff, technology) or output (amount of anti-icing materials).

Validity

The study proposed that the performance measurement of winter road maintenance should be based on friction resistance value as intermediate outcome while defining the relationship with the final outcome, but it requires validity for level setting of the final outcome. In other words, it means what final outcome the winter should offer as compared with the summer, and how many anti-icing application amounts are permitted from a viewpoint of environmental impact reduction. It is necessary to make sure of the appropriate level of intermediate and final outcomes through discussions with authorities concerned.

Issue of Preliminary Study Result

In this preliminary study, the study terms vary from index to index. The study applied annual values for input (equipments and cost), output (amount of anti-icing materials), and traffic accident and total complaints from road users as the final outcome. On the other hand, friction resistance as the intermediate outcome and travel speed as the final outcome are measurement results only for one day. Moreover, since these are single fiscal year data, the study does not perform the evaluation for continued years. Furthermore, the results are for a specific route (section), and comparative evaluation with other sections cannot be performed.

CONCLUSIONS

Throughout the course of this paper, we have attempted to demonstrate how the logic model works to evaluate the policy regarding winter road maintenance. The study is limited to analysis of the single fiscal year data for the specific route. In consideration of the following points, the future study will focus on a proposal of the model to evaluate and manage the performance of winter road maintenance from the viewpoint of availability, validity, efficiency, and reliability:

- Clarification of the relationship between intermediate and final outcomes,
- Organization of appropriate intermediate and final outcomes,
- Study of yearly data on intermediate and final outcomes (travel speed),
- Study of data for the specific route for continued years, and
- Comparison study with two or more routes.

In addition to the proposal of the model, making sure of the following points through exchange of opinions with road authorities and road users, the study can also contribute to achievement of the accountability of winter road maintenance:

- What is the outcome of winter road maintenance originally?
- How much is the level?
- What is the point at which an improvement is required?
- How achieve it?
- Is there a scheme that lowers cost?
- What technical development is necessary?

Answering these questions is the main theme of the future study, and the next paper will discuss the state of the art of winter road maintenance using this logic model.

REFERENCES

1. Asano, M. *Policy Evaluation of Winter Road Maintenance in Hokkaido*. CERI Report No. 125. Civil Engineering Research Institute for Cold Region, 2006.
2. Asano, M. *Development of Winter Model for Winter Road Management in Sweden*. YUKI No. 66. Snow Research Center, 2007, pp. 104–110.

3. Falls, C., R. Jurgens, and J. Chan. Performance Measurements for Snow and Ice Control in the Province of Alberta. Presented at 85th Annual Meeting of the Transportation Research Board, Washington, D.C., 2006.
4. *Policy Evaluation at MLIT*. Ministry of Land, Infrastructure and Transport (MLIT). <http://www.mlit.go.jp/hyouka/>. Accessed September 17, 2007.
5. *Performance Management of Road Administration in Japan*. Ministry of Land, Infrastructure and Transport (MLIT). <http://www.mlit.go.jp/road/management-e/index.html>. Accessed September 17, 2007.
6. Ugawa, Katsuya. *Legal System of Policy Evaluation: Description of Policy Evaluation Process and Ordinance*. Yuhikaku Publishing Co., Ltd., Tokyo, Japan, 2002.
7. Furukawa, S., and N. Kitaohji. *Practical Use and Theory of Public Sector Evaluation*. New Edition. Nihon Kajo Publishing Co., Ltd., Tokyo, Japan, 2004.

RELATIONSHIPS BETWEEN WINTER SERVICE AND WEATHER

Winter Model

Road Condition Submodel

STAFFAN MÖLLER

Swedish National Road and Transport Research Institute

The road condition model presented in this paper is a submodel in the Swedish winter maintenance management system, the Winter Model. The Winter Model will make it possible to assess the most important effects and their monetary value of changes in winter maintenance strategies and operations in Sweden. The effects are assessed for road users, road administrators, and the environment. The submodel road condition model is the central part of the Winter Model. The road condition model will characterize the state of a winter in terms of a road condition description hour by hour. The road condition model provides input data for other models where different effects such as accident risk, travel time, fuel consumption, road management costs, and environmental effects are assessed. In the first stage we have developed a model that will describe how road conditions are affected by weather, maintenance measures taken, and traffic on two-lane rural roads with a width of 7 to 9 m and speed limit of 90 km/h. To a great extent, the basis for developing the road condition model will be data already collected from nine observation sites, during one or two winter seasons, with the purpose of developing another submodel of the Winter Model, the accessibility model. For several periods, data from these observation sites contain information hour by hour regarding weather, traffic flow, initial road condition, and maintenance measures taken. Also specified types of road condition development—mainly connected with snowplowing and anti-icing treatment—can be studied. Additional information has been collected in special field surveys from the winter of 2002–2003. One survey covers the development of ruts down to the pavement in hard-packed snow or thick ice, caused by vehicles with studded tires. Also the mechanism for a wet or moist road to dry out has been studied. The road condition model will initially consist of the following nine submodels. The first five submodels are related to measures and the last four to traffic and weather: (a) anti-icing treatment, (b) snowplowing combined with anti-icing treatment, (c) snowplowing, (d) gritting, (e) grading, (f) rut development in hard-packed snow or thick ice, (g) condensation, (h) splashing from a wet road, and (i) drying of a moist road.

Investment planning for highways and streets has long included models for estimating different effects. The field of road maintenance and operation, especially winter maintenance and operation, is in this respect very neglected, being a weakness when competing for funds within a limited budget.

The aim of the Winter Model is to estimate and put a value on the most important impacts of the strategies and measures in winter road management for road users, road management authorities, and society at large. This will be a tool to find winter maintenance rules with the lowest possible socioeconomic costs.

STRUCTURE OF THE WINTER MODEL

The structure of the model appears in Figure 1.

The Winter Model consists of submodels for assessing the state of the road, the effects, and their monetary value and the total cost. The hub of the model is the road condition model. The road condition can be calculated for every hour, in five different strips across the road, influenced by the prior road condition, weather, traffic, and actions. Actions depend on what winter maintenance regulations and techniques are decided for a certain case. In the model, the weather throughout a whole winter season is defined by the roadway weather information system and other data on an hourly level. The data may be derived from any real winter or be estimated for an average winter. The road condition model controls calculations in the effect models: accident model, accessibility model, vehicle cost model, environment model, and model for road management costs. The accident model calculates accident rates, accident types, and consequences, all coupled with different road conditions and their duration. The accessibility model calculates the effect of different road conditions on mean speed and trip times. The

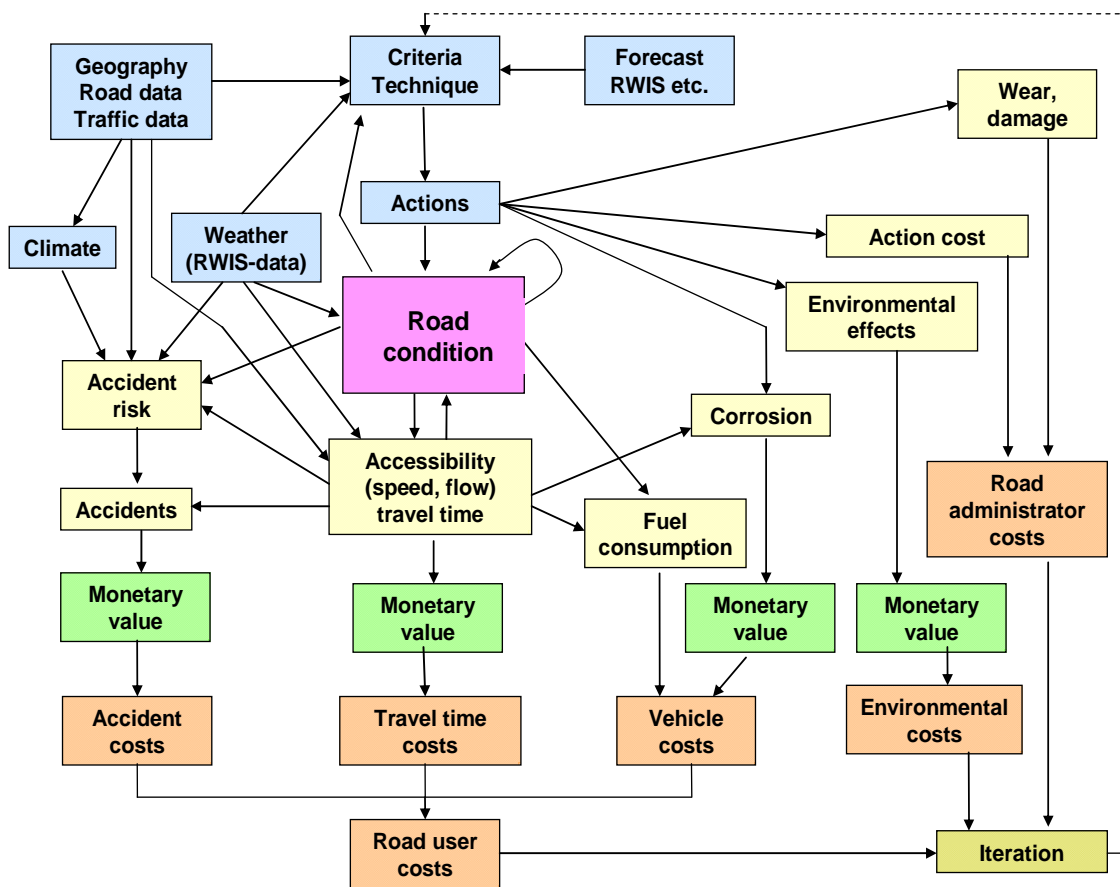

FIGURE 1 Flowchart of the Winter Model.

vehicle cost model calculates the costs of fuel consumption and corrosion due to road salt. The environment model calculates the impacts on roadside vegetation due to road salt. The model for road management costs calculates both the direct costs of the measures and the costs of damage to, and wear of, road surfacing, road markings, etc., as a result of road management measures.

STRUCTURE OF THE ROAD CONDITION MODEL

The first version of the road condition model will be constructed according to the following outline. The road condition will be described for each of five strips of the lane (Swedish Road Administration, 1996). In [Figure 2](#) half a carriageway is shown.

Input and output data to and from the road condition model are shown in [Figure 3](#).

Input Data

- Road condition during hour t (a 60-min period) for each of five strips of the lane.
- Amount of residual salt on the carriageway during hour t , if possible.
- Weather from the RWIS during hour $t+1$. Weather includes air temperature, road surface temperature, dew point temperature, type and amount of precipitation, wind speed, and weather situation. Examples of weather situations are snowfall, rain, blowing snow, and risk of slippery surfaces due for example to frost formation on a cold carriageway.

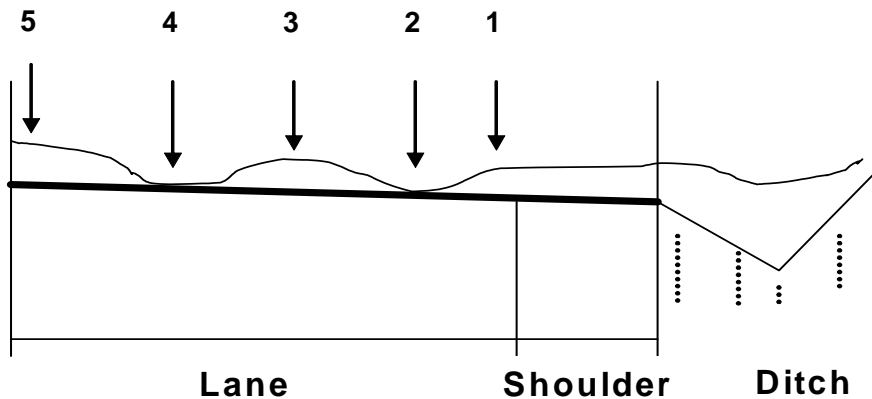

- 1 = Edge of lane
- 2 = Right wheel track
- 3 = Between wheel tracks
- 4 = Left wheel track
- 5 = Middle of the carriageway

FIGURE 2 Lane divided into five strips.

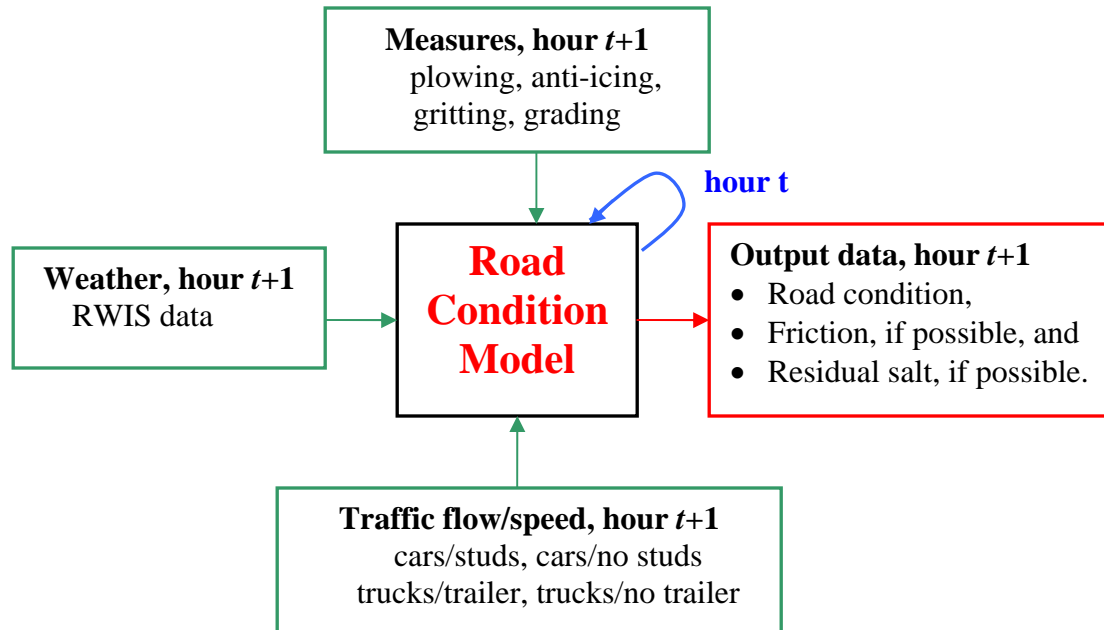

FIGURE 3 Input and output data to and from the road condition model.

- Traffic flow and average speed during hour $t+1$. Data are divided into cars using studded tires, cars not using studded tires, trucks with a trailer and trucks with no trailer.
- Maintenance measures taken during hour $t+1$. These data are divided into snowplowing, anti-icing treatment, snowplowing combined with anti-icing treatment, gritting, and grading.

Output Data

- Road condition during hour $t+1$ for each of five strips of the lane.
- Road condition during hour $t+1$ at an aggregated level. For example the following five types of road condition: dry bare ground, moist–wet bare ground, hard-packed snow–thick ice, black ice–hoar frost, and loose snow–slush.
- Friction class in wheel tracks during hour $t+1$, if possible.
- Amount of residual salt on the carriageway during hour $t+1$, if possible.

FIRST ATTEMPT AT A WINTER ROAD CONDITION MODEL

The road condition model will initially consist of the following nine submodels. The first five submodels are related to measures and the last four to traffic and weather. To get a starting point, when different winter maintenance strategies are going to be changed in the Winter Model, the submodels related to measures are built up around requirements specified in the present *General Technical Description of Operation Service Levels* (Swedish Road Administration, 2002).

Anti-Icing Treatment

It is assumed that anti-icing treatment is carried out with brine and that a salting pass takes 1 to 1.5 h depending on the standard class. Action on the road will begin 1 h after risk of slippery surfaces is indicated in the weather description. It is also assumed that anti-icing treatment is successful and that the road condition will change to wet bare ground.

Snowplowing Combined with Anti-Icing Treatment

It is assumed that snowplowing combined with anti-icing treatment is carried out with prewetted salt. The combined action will start when ≥ 1 cm of snow has fallen aggregated by the hour and will take 2 to 4 h depending on the standard class. Up to the moment when the combined action is started, the snow depth on the road will be a certain fraction of the fallen snow except in wheel tracks where snow depth also depends on the amount of traffic. When the action is taken the road condition will change to about 0.5 cm of loose snow except in wheel tracks where the snow depth will be even less. After the snowfall the road condition will gradually change to wet bare ground.

Snowplowing

Depending on the standard class snowplowing will begin when 2 to 3 cm of snow has fallen aggregated by the hour and the plowing pass is run for 5 to 6 h. As for the combined action, snow depth on the road, before action is taken, will be a certain fraction of the fallen snow except in wheel tracks where snow depth also depends on the amount of traffic. When snowplowing is carried out the road condition will change to about 0.5 cm of loose snow except in wheel tracks where the snow depth will be even less. When snowfall has ended and the last plowing pass is run, the road condition will often be black ice or hard-packed snow in the wheel tracks.

Gritting

Gritting is started when skid resistance is below certain limits. Regarding skid resistance there are three questions to be answered:

- What levels of skid resistance could approximately be related to different types of road condition?
- What increase in skid resistance could be expected when different measures are taken, e.g., deicing, gritting, and grading?
- What duration do different types of measures have?

Grading

Grading is carried out to prevent the development of excessive unevenness along or across a road covered with hard-packed snow or thick ice. The unevenness must not exceed 1.5 cm measured with a 60-cm-long straightedge. The road condition model will only deal with unevenness across the road due to rut development in hard-packed snow or thick ice. When grading is carried out,

the road condition will rapidly change to a more even surface of hard-packed snow–thick ice with no loose snow on top.

Rut Development in Hard-Packed Snow or Thick Ice

This submodel will estimate how quickly a layer of hard-packed snow or thick ice will be abraded down to the pavement by vehicles with studded tires. Analyses of data from special field surveys seem to indicate that the relative wear in the wheel tracks is ca. 0.0005 mm/car with studded tires in thick ice and ca. 0.007 mm/car with studded tires in hard-packed snow.

Condensation

When the temperature of the air falls, the air will sooner or later be saturated with water vapor. The temperature when air is saturated is called dew point temperature. Below this point air can not hold more vapor and condensation will begin. As far as roads are concerned condensation occurs when the road surface temperature is lower than the dew point temperature of the air. Depending on for example road surface temperature and residual salt, condensation will result in hoar frost or water on the road. To describe condensation a physical model based on road surface temperature, dew point temperature of the air, and other factors is used.

Splashing from a Wet Road

This submodel will describe which variables will have an effect on water splash from the road. Water can come from rain, sleet, or melted snow. The mechanism of splashing seems to be that water is torn off the road by the tires of vehicles and will follow the vehicle for a while as a cloud of water. When the cloud of water loses contact with the vehicle the drops of water will fall down again. Some drops will land on the road and some on each side of the road. Side wind will also help to take the drops away from the road. Observations during field surveys indicate that the following four variables are important to describe splashing:

- Traffic flow;
- Traffic composition, i.e., cars, trucks with no trailer and trucks with a trailer;
- Speed of traffic; and
- Wind speed and wind direction.

Drying of a Moist Road

When splashing has been going on for a certain period of time, the splashing mechanism will stop. It is reasonable to connect this change in mechanism to the change in road condition from wet to moist bare ground. Data indicate that this change will occur when the amount of water on the road is approximately 10 g/m². This will also mean that when the road condition changes from wet to moist bare ground, the submodel splashing will stop and submodel drying will start. The mechanism of drying is that moisture evaporates from the road. A literature search shows that at least the following three variables will affect the speed of drying:

- Road surface temperature,

- Dew point temperature of the air, and
- Wind speed.

Observations during field surveys indicate that four more variables are important to describe drying:

- Traffic flow;
- Traffic composition, i.e., cars, trucks with no trailer and trucks with a trailer;
- Speed of traffic; and
- Percentage of salt in the moisture.

ACKNOWLEDGMENTS

The author acknowledges the financial support for the Winter Model project by the Swedish Road Administration and the Swedish Governmental Agency for Innovation Systems.

RESOURCES

- Möller, S. *The Winter Model. Road Condition Model*. (In Swedish). VTI rapport 529. Linköping, Sweden, 2006.
- Vägverket (Swedish Road Administration). *ATB Vinter 2003. Allmän teknisk beskrivning*. (In Swedish). Publikation 2002:148. Vägverket, Borlänge, 2002.
- Vägverket (Swedish Road Administration). *Metodbeskrivning 105:1996. Bedömning av vinterväglag*. (In Swedish). Publikation 1996:59. Vägverket, Borlänge, 1996.
- Wallman, C.-G., S. Möller, G. Blomqvist, M. Gustafsson, A. Niska, G. Öberg, C. M. Berglund, and B. Karlsson. *The Winter Model, Stage 2. Final Report*. (In Swedish). VTI rapport 531. Linköping, Sweden, 2006.

RELATIONSHIPS BETWEEN WINTER SERVICE AND WEATHER

Estimating the Relationship Between Snow and Ice Maintenance Performance and Current Weather Conditions

THOMAS H. MAZE
 MASSIEL A. ORELLANA
 ALICIA CARRIQUIRY
 CHRIS ALBRECHT
Iowa State University

To determine the relative severity of winter, state transportation agencies (STAs) have used seasonal equations (the entire portion of the year when snow is expected) to measure whether the weather was exceptionally mild or exceptionally severe. Either mild or severe weather would justify less or more effort in fighting winter storms during the year. With an understanding of the severity of the weather, STAs may be better able to understand whether their performance was good, given the weather conditions. Some of these models were based on a statistical relationship between the average weather and the severity of fighting the weather, some were based on the relationship between physical properties and the weather, and others were based on educated guesses mixed with scientific theory. With the exception of our current effort, none of these approaches allowed for the evaluation of storm severity between storms or severity between locations (e.g., one route compared with another) although one is now being developed at the University of Iowa. This paper uses Minnesota Department of Transportation data to determine the relationship between local weather parameters and roadway segment performance information. Although it would seem obvious, the most important relationship estimated is between measureable weather parameters and performance. Because electronic data on weather variables are immediately available, severity can be measured between storms and between geographic locations immediately following a storm. This allowed for measuring performance and weather immediately following a storm to understand better the required adjustments for better performance in the future.

Several weather severity indexes are documented as part of our Minnesota Department of Transportation (MnDOT) report (1). There are three fundamental problems with existing weather indexes.

We know of only one index that does not use seasonal data to determine the relative severity of each storm. Most severity indexes require geographically limited weather data and assume that all points in the geographic region (state or district) have homogeneous weather (2). Although these assumptions are appropriate when one is making seasonal and broad comparisons, these assumptions are inappropriate for route-to-route, or storm-to-storm comparisons.

Weather severity indexes are generally estimated in two different ways. The first is through science and experience to determine which weather variables are important in determining how difficult it is to clear snow and ice. After determining the important weather variables, weights (parameters) for each variable are estimated by using statistical relationships or experience to determine the relative severity of weather experienced. In other words, weights (parameters) are estimated with past data to forecast the severity of future

winter seasons. For example, if salt usage or overtime hours can be used to determine the difficulty of snow and ice removal during a winter, the previous year's weather data can be related to output measures (such as salt usage and overtime) to create a regression equation with average weather conditions. In the future, we can simply use past experiences to determine what to expect. The problem with this kind of a regression equation is that we never know how the past will be reflected in the future performances. Because it is based on past data, it is a retrospective model.

The weather of each region of a state is unique, along with the methods to fight snow. This makes it important to have both local data and a model that has taken into account local conditions (e.g., traffic volume on the link). To illustrate how widely varied a district may be, we show a map of the districts in Minnesota in [Figure 1](#). For maintenance purposes, Districts 1, 3, 6, and 7 are broken into subdistricts. We use District 1 as an illustration to investigate if weather information collected at the district office (Duluth) may adequately represent the district as a whole. District 1 covers the areas between the northern Twin Cities' suburbs and the Canadian border along Lake Superior (over 200 mi) and then from the lake halfway across the state (over 200 mi). Given the size and the dramatic difference in topography across the district, weather measurements at a single point or even at a few points cannot be considered to be representative of the weather across the whole district.

OVERVIEW

The methodology proposed here does not solve all these issues but addresses several. The major shortcoming in our analysis is that it relies on past data and, therefore, is a retrospective approach. However, it at least provides a benchmark for performance.

The MnDOT uses the time following the end of a storm until bare lane is regained on a route as its performance measure. Each operator is trained to recognize when bare lane has been achieved and the times are passed upward from the operator to the truck station manager who then enters the time into a computer terminal. Sometimes the data are entered by the operator, avoiding the intermediate step involving the truck station manager.

There is a time goal for each roadway classification type, and in our analysis we used the relative achievement of the goal as the dependent variable. For example, if the objective for a super commuter roadway is 3 h, and bare pavement is achieved in 3 h, then the performance index (or dependent variable) for the segment becomes 1. If bare pavement is achieved after 4 h, then the performance index becomes 1.33 ($4/3 = 1.33$).

We used a mixed linear model to describe the relationship between the performance index and a set of roadway and weather-related covariates. Covariates included weather conditions (e.g., snow and maximum and minimum temperatures), location of the link, and time. This approach allowed for the comparison of the observed performance at a given route relative to the expected performance of all routes at the same time, and it also facilitated the comparison of performance between districts, between storms, or between routes.

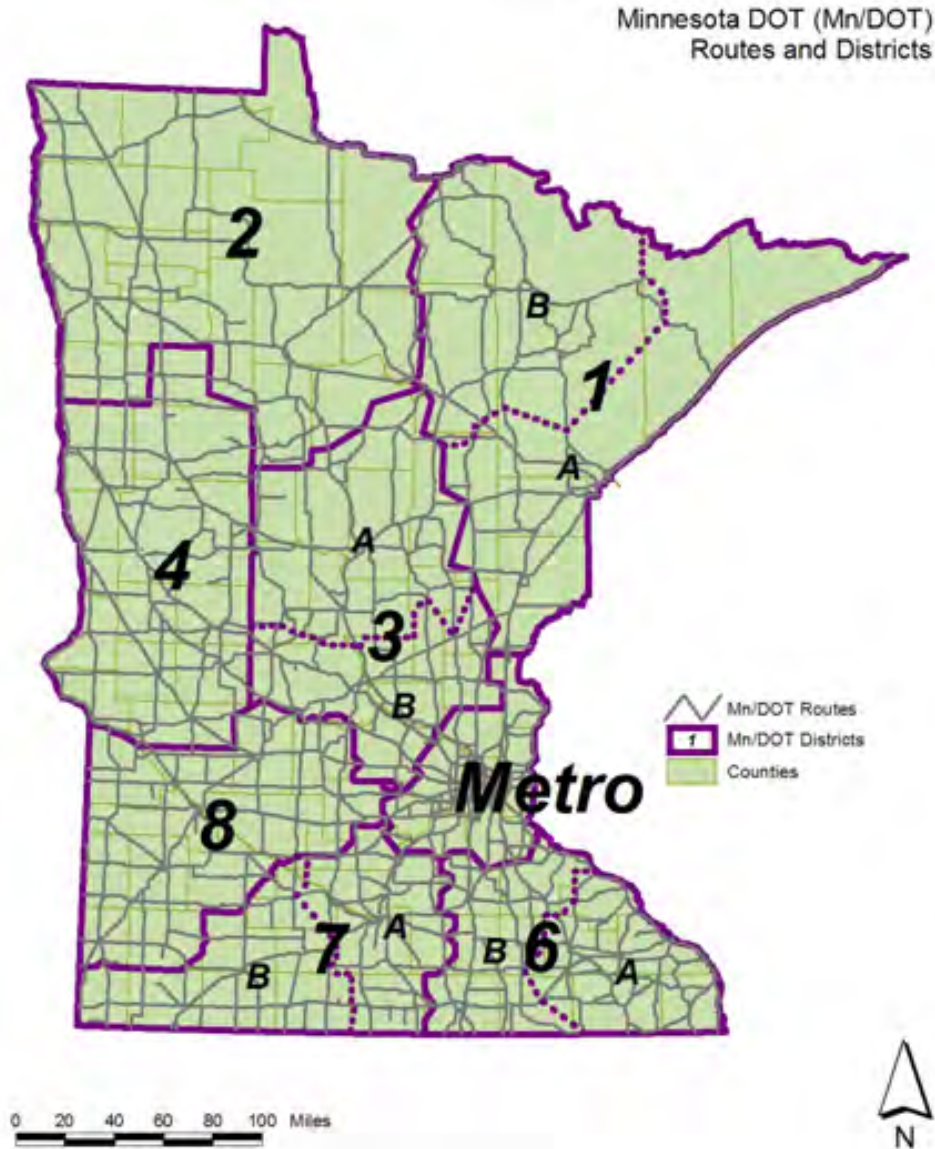

FIGURE 1 Map of district boundaries in the state of Minnesota.

APPROACH

We spoke with several MnDOT snow and ice operations managers and asked them which variables were important in determining the difficulty of snow and ice control. Of course, the answers we received were varied. Once we assembled a list of variables potentially associated with performance, we identified the subset that could be measured and for which data would be available within 24 to 48 h after a storm. Much of what we were told was not a surprise; for example, we heard that variables including depth of snowfall, velocity of the wind, and temperature during the storm (both relatively high and low temperatures) were believed to affect the performance of road-clearing crews. We were surprised to hear, however, that the orientation

of the road (north and south or east and west) appeared to affect snow and ice operations. Other variables arising from these discussions included items that we could not measure such as time of day the event ended, whether the skies were cloudy or sunny following the event, and whether the storm started with temperatures at or above 32°F and then dropped precipitously as the storm progresses. Although these variable are important in defining the difficulty of fighting the snow storm, they were either unable to give the immediacy of the data we required or outside our scope.

Minnesota benefits from a large number of road weather information system (RWIS) stations spread throughout the state: approximately 355 manual and automatic National Weather Service (NWS) stations, with about 40 NWS stations that report automatically and provide snow depth and temperature information. The locations of all automated NWS stations are shown in Figure 2. Unfortunately, not all stations report weather conditions reliably and within our time requirement. Figure 3 identifies the locations of the 76 functioning RWIS sites of MnDOT. Of these, approximately 53 reliably reported wind speed.

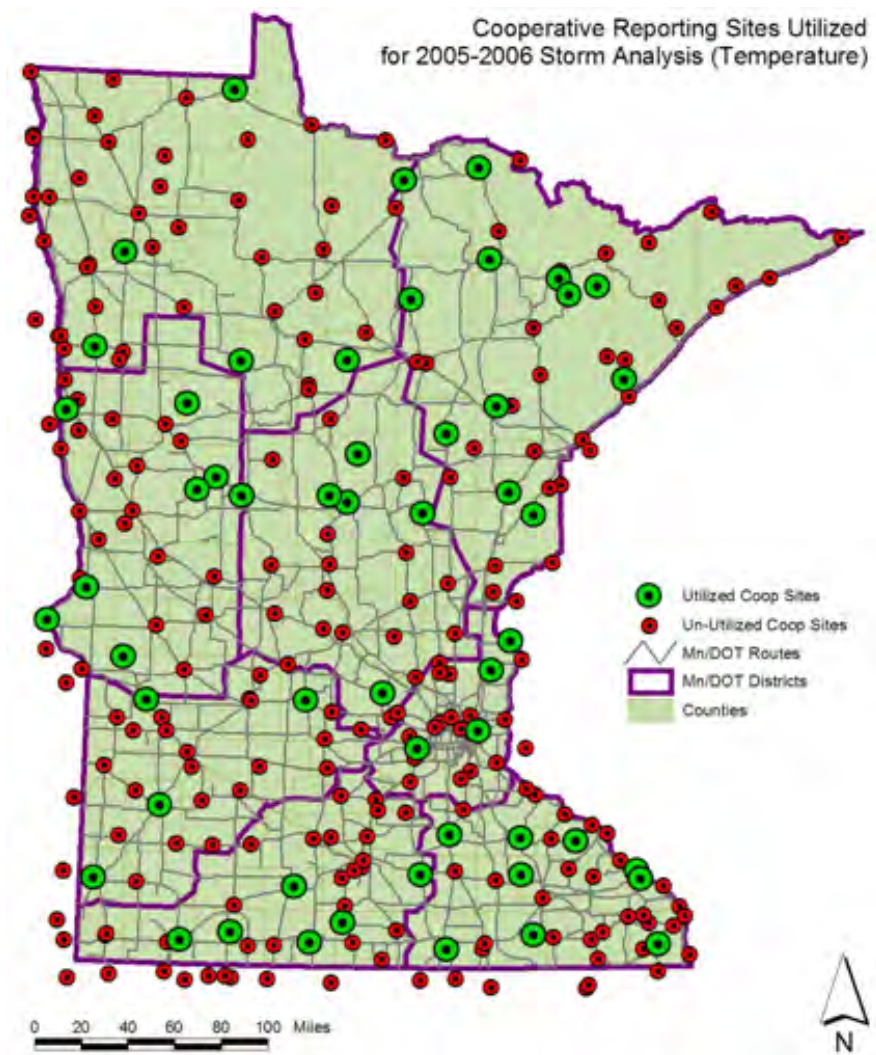

FIGURE 2 NWS sites, used and not used.

For the purposes of the statistical analyses that follow, plow route segments were joined to the nearest weather reporting station. The weather station paired to a plow route reporting a specific weather variable might be different from stations reporting other specific variables. That is, the choice of closest weather station to pair with a specific route might have differed weather conditions depending on which site was closest and also on which site was known to be reliable. Because some sites did not function throughout the entire year, sites might have changed during the year.

The distance to the nearest station was calculated on the basis of straight line distance. Several of the weather observing sites are manual and reporting weather information takes several weeks after the storm (usually by mail). These data might be used months after the winter season to more accurately define the weather. In our analysis, the only NWS data used were those reported within 24 h afterward by the Minnesota Climatological Service.

To obtain the direction or bearing of each roadway segment, each snowplow route segment was analyzed in a geographic information system (GIS) environment. GIS was used to determine the overall bearing, or direction in degrees from north between the beginning and ending point of

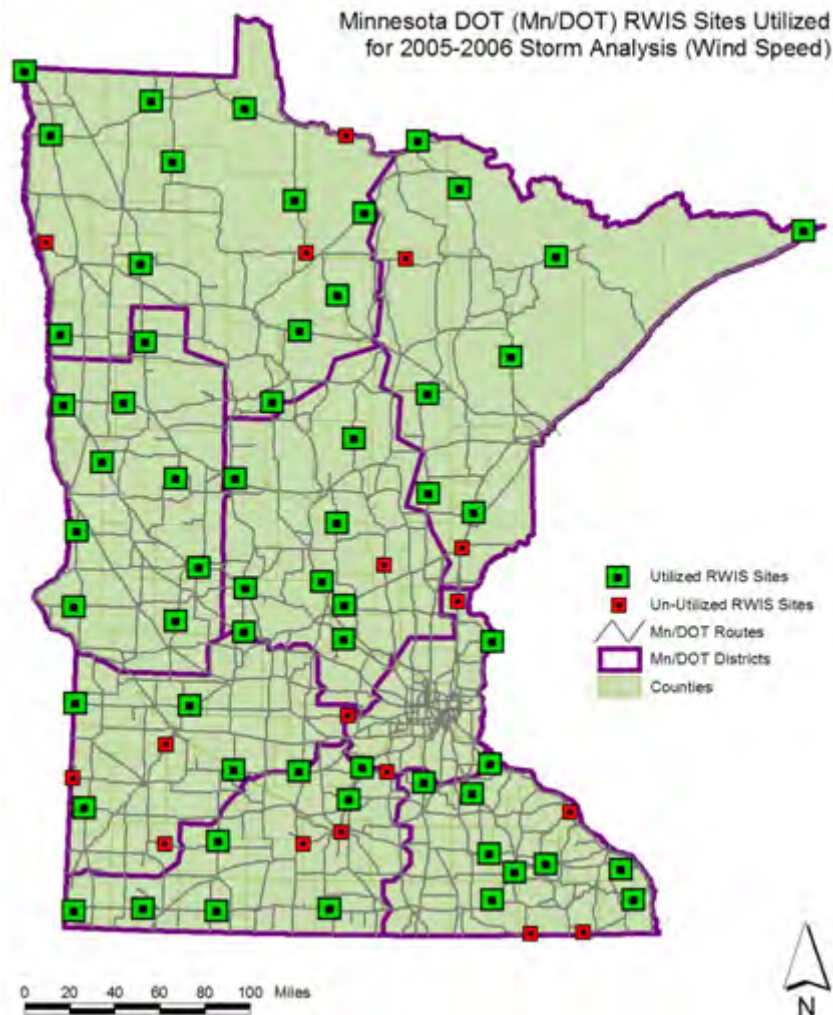

FIGURE 3 RWIS sites, used and not used in analysis

each segment for each roadway segment. When the overall segment bearing was within 15 degrees either way from north (between 345 degrees and 15 degrees from due north), the segment was considered a north–south roadway, and coded as such. Segments were also coded as north–south if their overall bearing was within 15 degrees either way from north (between 345 degrees and 15 degrees from due north), the segment was considered a north–south roadway, and coded as such. Segments were also coded as north–south if their overall bearing was within 15 degrees either way from due south. Segments were coded as east–west if their bearing was within 15 degrees of due east or due west. All other segments were coded as diagonal.

Thus, we could turn road segment direction into a dichotomous variable where 0 is for north–south routes and 1 is for east–west routes. We actually used separate variables for north–south and for east–west. If a segment was coded as north–south, it was given a 1 in the north–south category. East–west and diagonal roads were given a 0 in this category. In the east–west category, only roads with bearings coded as east–west were given a 1, while the remaining north south roads and diagonal roads were coded as 0.

We also included the latest ADT (average daily traffic) counts for the segment. The ADT are average volumes and probably do not reflect the volumes during the actual storm, but the volumes during the storm should be highly correlated with annual average volume.

MODEL ESTIMATION

During the winter of 2005 through 2006, we attempted to select events that covered the entire state or at least the majority of the entire state. Although it would have been preferable to have information from a larger number of storms, only the seven storms listed in [Table 1](#) met our criteria.

Roadway routes were grouped into five functional classifications for the purpose of identifying goals for time till bare pavement. Through market research, MnDOT found that drivers on lower volume roadways expected longer time until the snow was cleared. The levels of customer expectation and the level of the performance for the goals are listed in [Table 2](#). This classification was used to create the performance goal variables identified in [Table 3](#).

[Tables 4, 5, and 6](#) contain descriptive information. In [Table 4](#), we list districts and subdistricts across the top, and down the side the data are organized by storm (1–7) and route classification (P = primary, RC = route commuter, S = secondary, SC = super commuter, and UC = urban commuter). Some districts have no roadways of a certain classification. For example, within the metropolitan area, clearing snow and ice on the primary and secondary roadways is the responsibility of cities and

TABLE 1 Storms Modeled

Storm	Date
1	11/29/2005
2	12/14/2005
3	12/30/2005
4	1/31/2006
5	2/15/2006
6	3/13/2006
7	3/15/2006

TABLE 2 Route Classification

Route Classification	Traffic Volume	Goal
Super commuter	More than 30,000	3 h
Urban commuter	10,000–30,000	5 h
Rural commuter	2,000–10,000	9 h
Primary	800–2,000	12 h
Secondary	Less than 800	36 h

TABLE 3 Variable Table

Index Variables	Variable Definition	Type of Variable	Variable
District	Geographical location of observation	Classification	Districti
Storm of the season	1,2,3, ...	Classification	Stormj
Volume	Average volume on roadway/1,000	Continuous	Volumeijk
Performance relative to goal	Actual bare lane time/goal	Continuous	Yijk
Route orientation	Route is E–W or N–S	Integer variable	EWijk
Snow quantities	Amount of snow at nearest NWS site	Continuous	Snowijk
Wind speed	Maximum wind speed at nearest NWS site	Continuous	Windijk
Maximum temperature	Maximum temperature recorded by nearest NWS site	Continuous	Tmax ijk
Minimum temperature	Minimum temperature recorded by nearest NWS site	Continuous	Tminijk

counties. Table 5 uses the same matrix format to list the percentage of time the district made or exceeded its goal for each roadway classification. In other words, if the cell listed a 1.0, then 100% of the goal for that storm was met in that district. As can be seen from the data in Table 5, cells representing a higher volume roadway commonly have percentages approaching 1.0. Over time, we believe the time with bare lane goal has become a standard.

Table 6 shows the proportion of segments reporting zero for time till bare pavement. This means that the segment either never lost bare pavement or the section never regained bare pavement. Not knowing which was the case, and the zero adding no new information, these data were eliminated from further analysis.

MODEL ESTIMATION

Figure 5 shows the distribution of the performance index (time bare lane/goal) on the horizontal axis and the number of occurrences on the vertical for the storm that occurred on March 13, 2006. As can be seen, observations are nonnegative and are not normally distributed. Because of its clear skew to the right, the distribution of the response variable does not meet the assumption of normality.

We first transformed the response variable into (near) normality by taking its log. The response variable is our performance measure (along the horizontal axis in Figure 6), and the number of cases is along the vertical axis (in Figure 6). The distribution of the log-performance indexes is

TABLE 4 Performance Observation per Route per Districts, per Storm

Storm	Route Type	D1	D2	D3A	D3B	D4	D6E	D6W	D7E	D7W	D8	Metro
1	P	53	175	72	33	126	69	37	70	56	232	0
1	RC	234	254	160	169	111	148	191	159	132	305	177
1	S	100	47	11	4	42	5	0	8	1	14	0
1	SC	12	0	0	26	0	15	9	7	0	0	642
1	UC	105	23	61	162	57	68	68	81	51	0	300
2	P	53	202	76	33	126	69	37	70	54	232	0
2	RC	243	273	160	169	111	158	191	159	110	305	196
2	S	100	57	11	4	42	8	0	8	1	14	0
2	SC	12	0	0	26	0	15	9	7	0	0	642
2	UC	123	23	61	162	57	75	74	81	51	0	300
3	P	53	202	77	33	126	69	33	70	56	232	0
3	RC	243	273	160	175	111	150	184	166	132	305	196
3	S	100	57	11	4	42	8	13	8	1	14	0
3	SC	12	0	0	26	0	15	9	7	0	0	642
3	UC	105	23	74	162	57	75	76	81	51	0	300
4	P	53	202	77	36	126	0	15	16	47	232	0
4	RC	243	273	158	175	106	9	157	95	88	305	196
4	S	100	57	11	4	42	0	0	0	1	14	0
4	SC	12	0	0	26	0	0	9	7	0	0	642
4	UC	123	23	74	162	57	6	52	48	28	0	300
5	P	0	92	41	0	19	69	37	63	56	115	0
5	RC	15	118	13	37	39	150	189	161	128	191	196
5	S	18	11	6	0	26	8	13	7	1	6	0
5	SC	5	0	0	6	0	15	9	7	0	0	642
5	UC	25	4	0	29	28	75	76	81	47	0	300
6	P	22	151	40	33	121	68	39	14	51	232	0
6	RC	102	201	59	169	88	156	203	222	151	306	164
6	S	30	47	0	4	31	8	13	8	1	14	0
6	SC	13	0	0	26	0	15	9	7	0	0	646
6	UC	83	19	32	152	46	73	74	85	36	0	287
7	P	1	51	9	27	126	69	37	70	54	227	0
7	RC	1	35	6	169	78	150	189	166	123	305	196
7	S	1	31	0	4	38	8	13	8	1	13	0
7	SC	1	0	0	26	0	15	9	7	0	0	642
7	UC	1	0	0	162	38	75	74	81	46	0	300

TABLE 5 Percentage of Observations Meeting Goal

Storm	Route Type	D1	D2	D3A	D3B	D4	D6E	D6W	D7E	D7W	D8	Metro
1	P	0.51	0.44	0.44	0.91	0.37	0.87	0.84	0.94	0.89	0.41	NA
1	RC	0.70	0.41	0.43	0.93	0.54	0.97	0.91	0.70	0.54	0.45	1.00
1	S	0.86	0.38	0.00	1.00	0.88	1.00	NA	1.00	1.00	0.93	NA
1	SC	1.00	NA	NA	0.54	NA	1.00	1.00	1.00	NA	NA	1.00
1	UC	0.67	0.00	0.38	0.89	0.51	1.00	0.72	0.96	0.86	NA	1.00
2	P	1.00	0.82	1.00	1.00	1.00	0.77	1.00	1.00	1.00	1.00	NA
2	RC	1.00	1.00	1.00	1.00	1.00	0.78	1.00	1.00	0.66	1.00	0.89
2	S	1.00	1.00	1.00	1.00	1.00	1.00	NA	1.00	1.00	1.00	NA
2	SC	1.00	NA	NA	1.00	NA	1.00	1.00	1.00	NA	NA	0.98
2	UC	1.00	1.00	1.00	1.00	1.00	0.67	0.92	1.00	0.92	NA	0.96
3	P	0.68	1.00	0.92	0.73	0.64	0.94	0.42	1.00	0.89	0.49	NA
3	RC	0.80	1.00	0.97	0.82	0.46	0.89	0.78	1.00	0.95	0.76	1.00
3	S	0.90	0.91	1.00	1.00	0.95	1.00	1.00	1.00	1.00	1.00	NA
3	SC	1.00	NA	NA	1.00	NA	1.00	1.00	1.00	NA	NA	1.00
3	UC	0.76	0.83	1.00	0.86	0.84	0.91	0.67	1.00	0.84	NA	1.00
4	P	0.91	0.37	0.81	0.72	1.00	NA	1.00	1.00	1.00	0.94	NA
4	RC	0.94	0.36	0.36	0.77	0.63	1.00	1.00	0.95	0.74	0.52	1.00
4	S	1.00	1.00	1.00	1.00	1.00	NA	NA	NA	1.00	1.00	NA
4	SC	1.00	NA	NA	0.69	NA	NA	1.00	1.00	NA	NA	0.98
4	UC	0.79	0.91	0.00	0.44	0.79	1.00	1.00	1.00	1.00	NA	1.00
5	P	NA	1.00	1.00	NA	1.00	0.57	0.84	0.87	1.00	1.00	NA
5	RC	1.00	1.00	1.00	1.00	0.74	0.53	0.86	0.91	1.00	1.00	1.00
5	S	1.00	1.00	1.00	NA	0.89	1.00	1.00	1.00	1.00	1.00	NA
5	SC	1.00	NA	NA	1.00	NA	0.00	1.00	1.00	NA	NA	1.00
5	UC	1.00	1.00	NA	1.00	0.93	0.47	0.67	0.82	1.00	NA	1.00
6	P	0.46	0.78	1.00	0.09	0.62	0.93	0.10	0.00	0.69	0.12	NA
6	RC	0.44	0.85	1.00	0.59	0.86	0.82	0.21	0.03	0.46	0.02	0.85
6	S	1.00	0.66	NA	1.00	1.00	1.00	1.00	1.00	1.00	1.00	NA
6	SC	1.00	NA	NA	0.46	NA	0.60	0.00	0.00	NA	NA	0.75
6	UC	0.87	1.00	0.72	0.39	0.72	0.49	0.22	0.39	0.11	NA	0.84
7	P	0.46	0.78	1.00	0.09	0.62	0.93	0.10	0.00	0.69	0.12	NA
7	RC	0.44	0.85	1.00	0.59	0.86	0.82	0.21	0.03	0.46	0.02	0.85
7	S	1.00	0.66	NA	1.00	1.00	1.00	1.00	1.00	1.00	1.00	NA
7	SC	1.00	NA	NA	0.46	NA	0.60	0.00	0.00	NA	NA	0.75
7	UC	0.87	1.00	0.72	0.39	0.72	0.49	0.22	0.39	0.11	NA	0.84

TABLE 6 Proportion of Routes with Time Until Bare Pavement of Zero or Better

Storm	Route Type	D1	D2	D3A	D3B	D4	D6E	D6W	D7E	D7W	D8	Metro
1	P	0.40	0.44	0.29	0.91	0.37	0.12	0.46	0.21	0.32	0.17	NA
1	RC	0.63	0.34	0.15	0.40	0.54	0.11	0.17	0.21	0.21	0.07	1.00
1	S	0.50	0.34	0.00	0.00	0.48	0.00	NA	0.00	1.00	0.00	NA
1	SC	1.00	NA	NA	0.31	NA	0.00	0.00	0.00	NA	NA	0.96
1	UC	0.67	0.00	0.08	0.17	0.51	0.24	0.46	0.80	0.63	NA	1.00
2	P	1.00	0.47	1.00	1.00	0.79	0.45	0.84	0.73	0.00	0.12	NA
2	RC	0.81	0.64	1.00	1.00	0.88	0.62	0.91	0.84	0.05	0.36	0.89
2	S	1.00	0.81	1.00	1.00	0.91	1.00	NA	1.00	0.00	0.00	NA
2	SC	1.00	NA	NA	1.00	NA	1.00	1.00	1.00	NA	NA	0.98
2	UC	1.00	0.91	1.00	1.00	0.84	0.67	0.66	0.94	0.12	NA	0.96
3	P	0.08	0.14	0.01	0.73	0.64	0.22	0.12	0.43	0.54	0.22	NA
3	RC	0.19	0.18	0.14	0.49	0.34	0.36	0.38	0.49	0.36	0.14	0.72
3	S	0.04	0.12	0.00	0.00	0.62	0.38	1.00	0.88	1.00	0.29	NA
3	SC	0.00	NA	NA	0.54	NA	1.00	0.00	1.00	NA	NA	0.93
3	UC	0.15	0.74	0.08	0.39	0.51	0.67	0.21	0.46	0.65	NA	0.93
4	P	0.00	0.12	0.00	0.00	0.02	NA	1.00	0.00	0.81	0.11	NA
4	RC	0.09	0.03	0.04	0.02	0.03	1.00	1.00	0.34	0.65	0.05	0.91
4	S	0.00	0.14	0.00	0.00	0.21	NA	NA	NA	1.00	0.07	NA
4	SC	0.00	NA	NA	0.46	NA	NA	1.00	1.00	NA	NA	0.91
4	UC	0.30	0.74	0.00	0.06	0.00	1.00	1.00	0.90	1.00	NA	0.98
5	P	NA	1.00	1.00	NA	0.74	0.57	0.22	0.46	0.66	1.00	NA
5	RC	1.00	1.00	1.00	1.00	0.74	0.53	0.35	0.47	0.72	1.00	0.98
5	S	1.00	1.00	1.00	NA	0.69	1.00	1.00	0.57	0.00	1.00	NA
5	SC	1.00	NA	NA	1.00	NA	0.00	0.00	0.00	NA	NA	0.99
5	UC	1.00	1.00	NA	1.00	0.71	0.35	0.21	0.36	0.49	NA	0.98
6	P	0.46	0.03	0.10	0.09	0.03	0.07	0.10	0.00	0.00	0.08	NA
6	RC	0.09	0.24	0.34	0.16	0.31	0.18	0.21	0.03	0.06	0.02	0.62
6	S	0.03	0.00	NA	1.00	0.39	0.38	1.00	0.00	0.00	0.00	NA
6	SC	0.00	NA	NA	0.46	NA	0.60	0.00	0.00	NA	NA	0.73
6	UC	0.35	0.90	0.00	0.22	0.17	0.45	0.22	0.39	0.11	NA	0.75
7	P	1.00	1.00	1.00	0.00	0.09	0.20	0.46	0.56	0.00	0.04	NA
7	RC	1.00	1.00	1.00	0.31	0.28	0.23	0.32	0.32	0.16	0.06	0.81
7	S	1.00	1.00	NA	0.00	0.32	0.38	0.00	0.50	0.00	0.00	NA
7	SC	1.00	NA	NA	0.00	NA	0.00	0.00	1.00	NA	NA	0.93
7	UC	1.00	NA	NA	0.06	0.47	0.25	0.27	0.98	0.09	NA	0.84

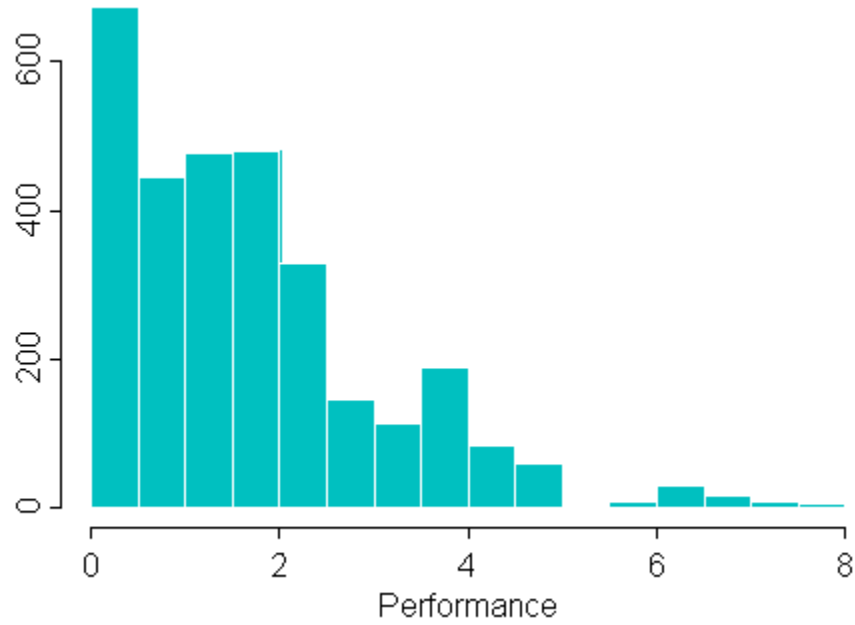

FIGURE 5 Response variable for March 13, 2006.

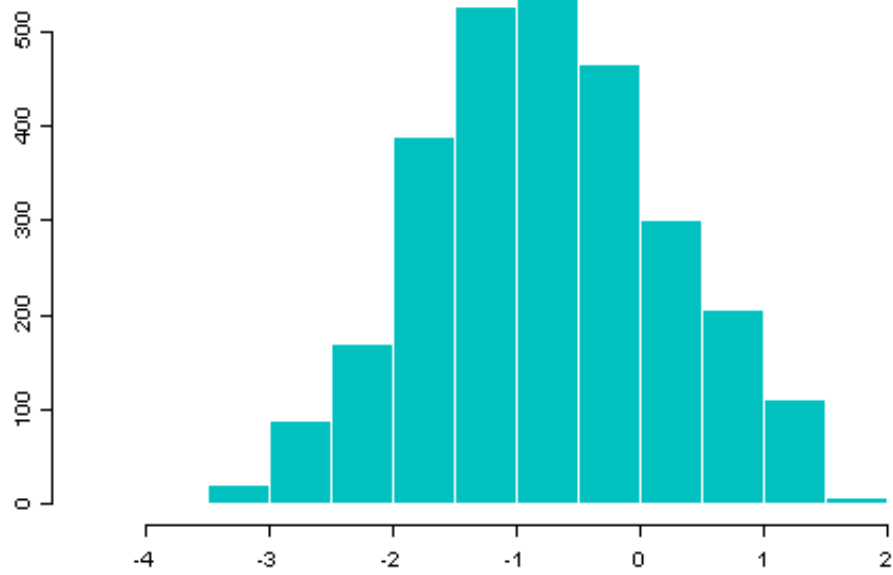

FIGURE 6 Observed distribution of the log-performance index.

shown in Figure 6. Even by inspection the distribution of the log-performance index appears to be symmetric and thus a normal distribution can be considered a plausible probability model. The response variable, is therefore assumed to be a log-normal random variable and after a log transformation the response can be modeled as a linear function of the covariates X , a vector of unknown parameters β , and a random error as shown below:

$$Y = X\beta + \varepsilon \quad (1)$$

where

$$\varepsilon \sim N(0, \sigma^2)$$

The specific form of the proposed model is as follows:

$$y_{ijk} = \beta_0 + \beta_1 * \text{district}_i + \beta_2 * \text{volume}_{ijk} + \beta_3 * EW_{ijk} + \beta_4 * \text{snow}_{ijk} + \beta_5 * \text{wind}_{ijk} + \beta_6 * T \max_{ijk} + \beta_7 * T \min_{ijk} + S_j + \varepsilon_{ijk} \quad (2)$$

The model in Equation 2 is known as a mixed linear model because it includes fixed and random effects among the covariates. In the model, y_{ijk} denotes the log-performance index of the k th route segment in the i th district, j th storm, $\beta_0 \dots \beta_7$ are regression coefficients associated with the fixed effects in the model, ε_{ijk} and S_j are random variables, and

$$\begin{aligned} \varepsilon_{ijk} &\sim N(0, \sigma_\varepsilon^2) \\ \text{and} \\ S_j &\sim N(0, \sigma_S^2) \end{aligned} \quad (3)$$

The independent variables—district, orientation of segment, and storm—are categorical variables rather than continuous variables such as temperature and snowfall depth. We fitted the model using SAS Proc Mixed and selected the best-fitting model using the Akaike Information Criterion (AIC). Table 7 shows the f -statistics for each variable in the proposed model. These f -statistics correspond to the test of the null hypothesis of a zero coefficient associated with each of these effects after all other effects have already been adjusted in the model. All p -values are at or below the 5% level of significance.

The estimated model is shown in Equation 4, below. Interpreting the results is slightly counterintuitive, and the classification variable cannot be interpreted without more information. The log response variable becomes smaller when performance is improved. In other words, performance is improved when the average daily volume is greater and when the maximum temperature is higher. Performance is negatively associated with road orientation (east–west is worse), snowfall depth, and wind speed. All of these results agree with our experience.

$$\begin{aligned} \hat{y}_{ijk} = &0.8875 + \beta_{\text{district}} - 0.0347 * \text{volume}_{ijk} + 0.03719 * EW_{ijk} + 0.07381 * \text{snow}_{ijk} \\ &+ 0.003638 * \text{wind}_{ijk} - 0.05677 * T \max_{ijkl} + 0.03679 * T \min \end{aligned} \quad (4)$$

TABLE 7 *F*-test

Variable	<i>F</i>-Value	Pr > <i>F</i>
District	25.93	<0.0001
Volume	11.55	0.0007
EW	4.29	0.0384
Snow	232.44	<0.0001
Wind	11.08	0.0009
Tmax	812.24	<0.0001
Tmin	380.80	<0.0001

To confirm whether the assumption of normality for the response variable is plausible and to investigate whether important variables may be missing from the model, we carried out an analysis of the estimated residuals from the model.

Figure 7 shows the residuals plotted against the predicted response variable (top left panel), the distribution of the estimated residuals (top right panel), a quantile–quantile (Q-Q) plot of the residuals (bottom left panel), and a box plot of the residual distribution (bottom right panel). The residuals are estimated as the arithmetic difference between dependent variable forecasts by the model and the actual value for each data case. We can see that the residual plot shows no trend or unexpected behavior and that, as expected, the residuals are approximately normally distributed, with zero mean, suggesting that the proposed model fits the data well.

Table 8 shows the estimated regression coefficient associated with each level of the categorical variable district. Metro District was used as a reference, and thus the coefficients in the table represent the difference between performance in a given distribution and in Metro under similar weather, road-type, and orientation conditions. Recall that overall there is a district effect on performance even though not all districts differ. From the table, for example, we see that Districts DB3, D6W, D7W, and Metro do not have statistically significant performance indexes when all other variables are equal. These district-level parameter estimates take into account differences between topography, route structure, and other variables that are unique to the district or subdistrict. For example, D1 is located in the far northeastern area of Minnesota and along Lake Superior, and D2 is in northwestern Minnesota along the North Dakota and Manitoba border. In both cases snowplow routes are long, are sparser, and have more difficult terrain; hence, poorer performance is observed when compared with other areas.

The route-classification categorical variable was accompanied by a statistically significant set of regression coefficients, indicating that different road types exhibit different levels of the performance index. The road type with the best performance index (more commonly meeting the goal) was that with the greatest volume. Indeed, because volume and road type are highly correlated, individually interpreting the effects of volume and road type on performance is difficult.

CONCLUSIONS

We have investigated whether we can predict the performance of snow and ice removal units by using weather, roadway, and location information. Our results suggest that it is possible to use

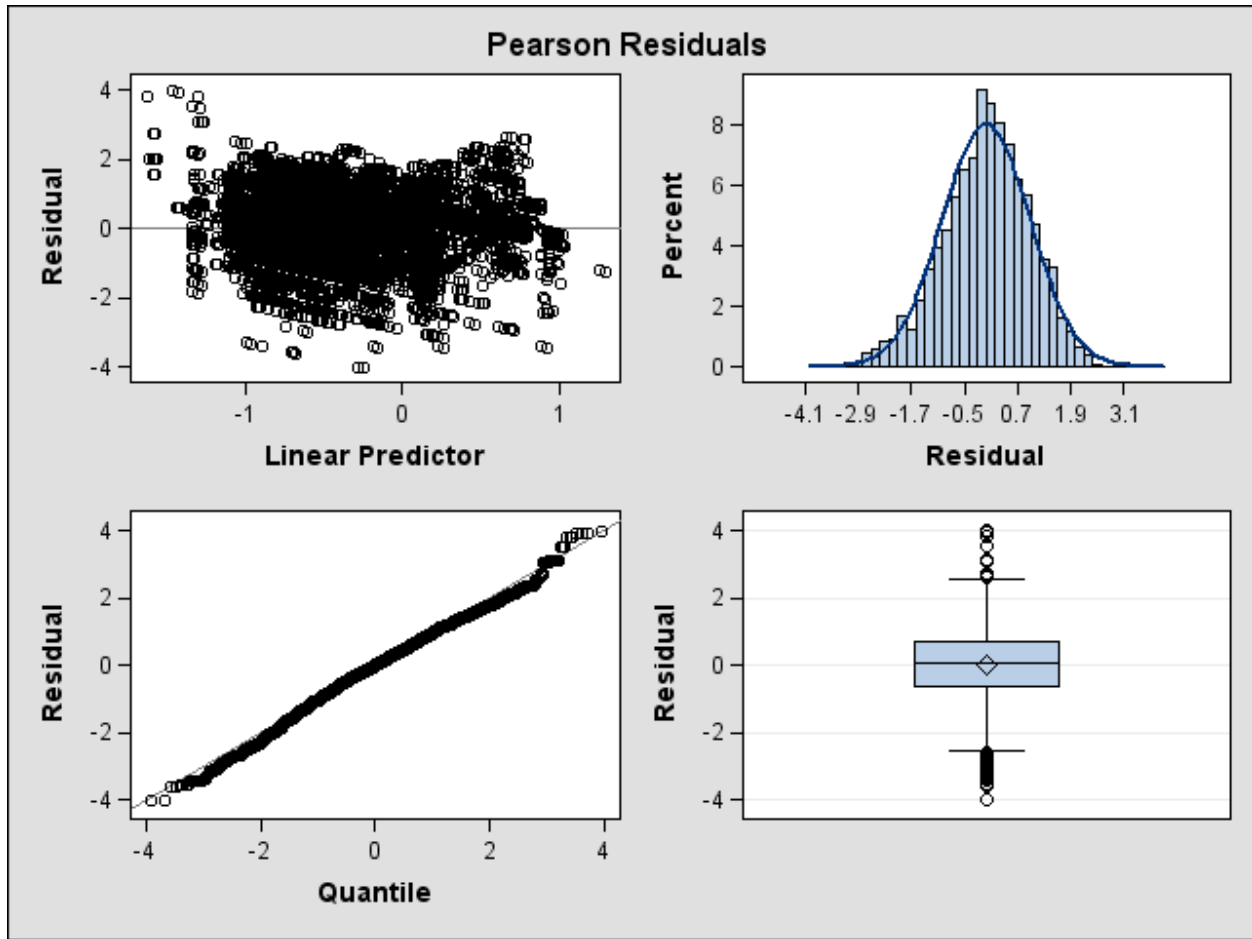

FIGURE 7 Residual analysis of model (1).

TABLE 8 Estimates for District

District	Estimate	Standard Error	t-value	p-value
D1	-0.2430	0.0516	-0.71	<0.0001
D2	-0.2415	0.0505	-0.78	<0.0001
D3A	-0.3067	0.0533	-0.76	<0.0001
D3B	-0.0820	0.0466	-0.76	0.0785
D4	-0.5479	0.0516	-0.63	<0.0001
D6E	0.2362	0.0501	-0.71	<0.0001
D6W	0.0021	0.0499	0.04	0.9679
D7E	-0.2729	0.0512	-0.33	<0.0001
D7W	-0.0874	0.0521	-0.68	0.0936
D8	-0.3301	0.0462	-0.15	<0.0001
Metro	0	.	.	.

measurable weather information to estimate differences in snow and ice removal performance across routes, districts, subdistricts, and, hence, the severity of the storm. We fitted a mixed linear model to performance indexes provided by the MnDOT corresponding to seven statewide storms that occurred in the winters of 2005 and 2006. The model fitted using weather information collected from automatic weather recorders fit the response variable very well. In most cases, the data used were available within 24 to 48 h following a storm, allowing the DOT to make a rather quick assessment of the impact of storm on the performance of road cleaning crews through the state and to make a quick assessment of the weather's impact on snow and ice operation throughout the state.

In this paper we have developed the model using only 1 year of data. Clearly more data covering more years are required before proposing a model to be used operationally. However, even the current fitted model can provide a benchmark for measuring the weather's impact on snow and ice operations. Furthermore, only after the model is put into operation will we be able to determine whether model predictions coincide with experience.

Rather than a model itself, our work demonstrates that at least for the seven storms considered here, performance is statistically associated with weather and roadway characteristics. While this has been well known, the important contribution of our work is to show that performance can be accurately forecast by using readily available weather data. In fact, the model permits individual poststorm analysis, which in turn permits adjusting the operations of road-cleaning crews to improve performance before the winter season is over. This has the potential to increase the overall efficiency of the DOT relative to a simple year-end analysis.

ACKNOWLEDGMENT

The authors would like to thank the Minnesota Department of Transportation for its funding that led to this work. We particularly would like to thank Steve Haider, Curtis Gobeli, Gary Niemi, Gabriel Guevara, and Tom Zimmerman for their advice and insight into this issue.

REFERENCES

1. Maze, T. H., C. P. Albrecht, and N. Burdine. *Snow and Ice Operations Cost Analysis*. Office of Research Services, Minnesota Department of Transportation, St. Paul, Minn., 2007.
2. Nixon, W. A., and L. Qiu. Developing a Storm Severity Index. In *Transportation Research Record: Journal of the Transportation Research Board*, No. 1911, Transportation Research Board of the National Academies, Washington, D.C., 2005, pp. 143–148.

Weather and Pavements

WEATHER AND PAVEMENTS

Physical Processes That Affect Runway Surface Conditions During Winter Time

A Conceptual Model

ALEX KLEIN-PASTE

Norwegian University of Science and Technology

Nineteen physical processes are identified that can affect runway surface conditions during winter time. These processes have been arranged in a simple conceptual model to represent the dynamical behavior of runway surface conditions. Data was obtained from observations on operative runways and from conversations with Norwegian airport winter maintenance personnel. A framework has been developed to provide a systematic analysis of all pieces of information. The conceptual model has been implemented in an education program for Norwegian airport winter maintenance personnel and may be extended for road applications.

How good are the runway surface conditions? “Are they still acceptable?” “Do I need to do something?” “What kind of winter maintenance operations is required?” “When should these operations be performed?” These are a few daily questions for winter maintenance personnel at airports that operate under cold weather conditions. Clearly, the operational decision-making process is a challenging task. Ideally, the decisions are based on an evaluation of the prevailing runway surface conditions, the present and nearby weather situation, and the expected traffic. Although there are different guidelines, procedures, recommended practices, and other decision support systems available, the success of keeping runways open and ensuring traffic safety strongly depends on the expertise of the person in charge of the winter maintenance operations.

An important part of the operational decision-making process is the monitoring task. The person in charge has to follow the developments in surface conditions, weather, and traffic (in case of irregular traffic patterns). At airports, this task is in essence similar to that for road winter maintenance. However, there are some important differences. Each user of the airport (the pilot) is to be informed about the prevailing surface conditions. Maintenance personnel therefore need to describe the status of the runways, taxiways, and aprons in a report, which is disseminated to the pilots. This report, called SNOWTAM, is to be updated when significant changes in the conditions have occurred (1). This reporting system demands a high level of monitoring in order to detect these significant changes. Compared with roads, the total pavement area that is to be monitored at airports may be significantly less (typically a few kilometers), but a runway that is open for air traffic is inaccessible for maintenance personnel. Air traffic control has to give clearance and temporarily close the area for air traffic, in order to allow a ground vehicle to enter the area and inspect the runway surface conditions. The possibilities of inspecting the runway surface conditions are therefore limited.

The importance of timely updating of SNOWTAM reports has received considerable attention [see for example Biggs and Hamilton (2)]. Consequently, there is wealth of

observations, feelings, impressions, and theories available among airport personnel on how runway surface conditions change. However, most observations are undocumented and the feelings, impressions, and theories are not always carefully formulated or lack a physical basis to support the idea. A large amount of expertise on monitoring runway surface conditions is present as tacit knowledge among maintenance personnel. Tacit knowledge is a form of knowledge that people carry in their minds and is, therefore, difficult to access. Often, people are not aware of the knowledge they possess or how it can be valuable to others. Effective transfer of tacit knowledge generally requires extensive personal contact and trust (3).

Recently, a study has been conducted in Norway on runway operability under cold weather conditions (4). A part of this study addressed the question of how runway surface conditions change by systematically documenting the developments on operative runways (5). It provided valuable documented data, but it was recognized that the tacit knowledge of maintenance personnel was an additional source of valuable information. The extensive field activities of the whole project (in total 6 months during 3 winter seasons) and its objectives (understanding and supporting winter maintenance at airports) provided the necessary boundary conditions to develop a trust relationship with airport maintenance personnel in which they were willing to share some of their experiences.

The objective of this paper is to structure and condense both documented observations and experiences from airport maintenance personnel. A simple framework was developed to identify physical processes behind the observations, feelings, impressions, and theories. It provides a physical basis for the dynamics of operative runways under cold weather conditions. The analysis is exclusively performed for runways, but it can be extended for road applications.

FRAMEWORK

The term “runway surface conditions” or “surface conditions” is understood as the physical state of the runway surface. It includes the pavement texture with any form of contamination, such as snow, ice, slush, water and other substances such as sand and chemicals. Runway surface conditions are to allow takeoffs, landings, aborted takeoffs, and taxiing in a safe and effective manner. To do so, aircraft need to attain a certain level of acceleration, retardation, and directional control. Hence, the surface conditions should not excessively hamper acceleration, retardation, and directional control (6). Acceleration is hampered by loose snow or slush because it increases rolling resistance and impingement drag (water droplets or snow particles that spray from the tires and collide with the fuselage). Retardation and directional control are hampered when the level of attainable tire-pavement friction is reduced.

Surface conditions should not only support aircraft operations, they should also support winter maintenance. A surface may be good to operate aircraft on, yet it is still not a good surface for maintenance personnel. To understand this aspect one has to realize that winter maintenance takes time. The runway has to be closed in order to conduct maintenance operations. It is not possible to continuously conduct winter maintenance because the runway would be permanently closed. Hence, after a preparation, the surface should hold its properties over a certain period of time. It has to be robust to the coming weather and traffic situation (4). To clarify: a wet pavement may provide sufficient tire-pavement friction and little rolling resistance. Hence, it is no problem to operate aircraft on that surface. But when the pavement temperature approaches 0°C (32°F) and decreases, it can quickly lose its ability to provide the

friction. Hence, surface is vulnerable in this situation. In this situation, a wet pavement is not robust and therefore not a good surface for maintenance personnel. The ability of the surface conditions to hold its frictional properties is denoted as the robustness (4). The properties of the surface conditions (e.g., its ability to provide friction, robustness, rolling resistance) change over time due to different physical processes. Here, a process is understood as an event or phenomenon that changes the surface conditions.

The objective is to identify all known processes that can change the surface conditions. The first step is to categorize all possible processes into different groups. Here it is chosen to make a distinction after the origin of the process. Three groups are defined: meteorology, traffic, and winter maintenance. This classification forms the basis of the conceptual model and is illustrated in Figure 1.

The second step is to define a system boundary. Here it is chosen to place the boundary along the sidelines of the runway and it is enclosed by the two runway thresholds. The area enclosed by the system boundary is denoted the runway area. The surface conditions can change in three different ways: (a) by transport of matter (snow, ice, water, sand, chemicals) into the runway area, (b) by the removal of matter from the runway area, and (c) by changes in the consistency or distribution of the matter within the runway area. This gives a classification after the type of the process. The classification of processes after origin and type results in a 3×3 matrix.

IDENTIFICATION OF PROCESSES

The results from the observations on operative runways have been presented earlier (5). The conversations with runway maintenance personnel took place during the field investigations at six different airports (Oslo, Hammerfest, Tromsø, Kirkenes, Svalbard, and Bardufoss) in Norway during the winter seasons 2003–2004, 2004–2005, and 2005–2006. The total duration of the field activities was 6 months. The exact number of maintenance personnel that have been contacted

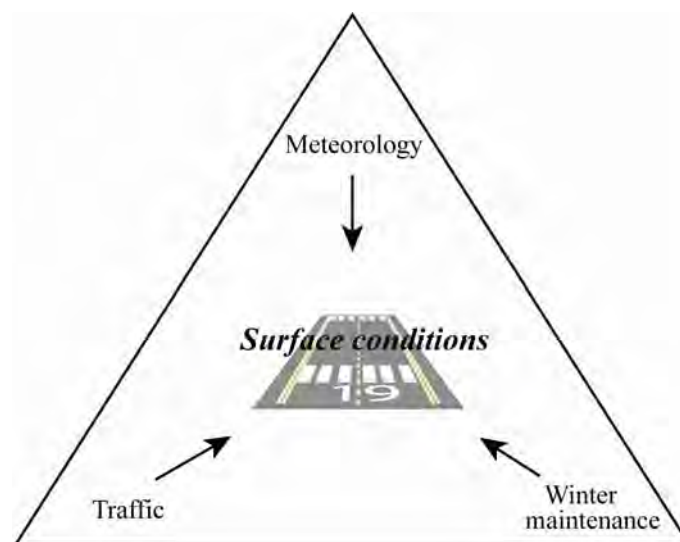

FIGURE 1 Basic conceptual model of processes affecting runway surface conditions.

is unknown, but it probably exceeds one hundred. Some of the conversations were systematically documented in the form of open interviews (7), but the majority of the information was obtained without such structured format. Most conversations took place simply while working with them, following them in their daily routines, and during coffee breaks. Whenever possible, notes were made after the conversation. However, the value of their words was not always directly appreciated, and a large amount of information remained undocumented.

A few examples will be given, how runway maintenance personnel typically expressed their observations: “The runway shoots ice.” “Even below 0°C (32°F), ice disappears and the runway can become bare and dry.” “Those aircraft engines blow everything aside.” “Leaving it (initially compacted snow) overnight and it is impossible to remove.” “Please, drive as little as possible on snow covered areas: the wheel tracks you create are difficult to remove.” “Ice gets smoother when aircraft operate on it, specifically at the turn-offs to the taxiways.” “At this moment, I would wait with applying chemicals: with a little help of the sun, we enter the evening with a nice, bare and dry runway.” “Every now and then we have to remove rubber deposits from the runway.” “If you apply chemicals, the runway becomes wet and all the drifting snow collects on the surface.” “When the runway is wet and the temperature is dropping you have to be alert, it can freeze within minutes.”

All pieces of information (from both conversations and documented observations) were analyzed by asking two questions: (a) Did the observed–described phenomenon change the runway surface conditions? (b) What was the physical process behind this observation that caused the change? This analysis initially was performed after the first field season, but repeated afterwards to ensure most information was incorporated in the analysis. The result is the identification of nineteen different processes that are presented in Table 1, categorized after origin and type. A short description or definition of each process is given in Table 2. The set of processes provides a conceptual model on how runway surface conditions change, which is presented in Figure 2.

TABLE 1 Processes That Affect Runway Surface Conditions, Classified After Origin and Type

Type \ Origin	Meteorology	Traffic	Winter Maintenance
Mass transport into the area	Precipitation Ice deposition Snow drift	Rubber deposition	Chemical application Sand application
Mass removal from the area	Run off Evaporation Sublimation Snow drift	Blow off	Mechanical removal
Changes in consistency or distribution	Melting Freezing Sintering Temperature changes	Compaction Polishing Redistribution	Chemical breakdown

TABLE 2 Definition or Description of the Processes

Process	Description or Definition
Precipitation	All solid and liquid forms of water that deposit from clouds.
Ice deposition	The direct deposition of ice from water vapor of the air above the pavement.
Snow drift	The transport of snow particles by wind onto, or away from the runway area.
Run-off	The gravity driven drainage of liquids from the runway surface.
Evaporation	The transfer of liquid water to water vapor.
Sublimation	The direct phase change of water in solid form (snow or ice) to water vapor.
Melting	The phase change from solid to liquid.
Freezing	The phase change from liquid to solid.
Sintering	The growth of bonds (necks) between snow crystals. This process strengthens compacted snow over time. It turns compacted snow into ice.
Temperature changes	Changes in the temperature of any snow or ice contamination (tire-snow/ice friction is temperature dependent).
Rubber deposition	The transfer of rubber from tires to the pavement.
Blow-off	The removal of mass induced by traffic.
Compaction	Densification of snow by tires traveling on snow covered pavements.
Polishing	The loss of (micro) texture due to mechanical exposure of tires, and mechanical removal equipment.
Redistribution	The displacement of loose matter (snow, sand, slush, chemicals) within the runway area, induced by air turbulences that are created by aircraft.
Chemical application	The application of any type of anti- or deicing chemicals.
Sand application	The application of any type of abrasives.
Mechanical removal	All forms of snow, ice, or slush removal by means of plowing, scraping (including scarifying), brushing, or blowing.
Chemical breakdown	Changing the structure of snow and ice by means of chemicals. It includes penetration, undercutting, and melting.

DISCUSSION OF CONCEPTUAL MODEL

The objective for airport winter maintenance personnel is rather plain and clear: ensure that aircraft can use the runway safely and effectively. Among experienced maintenance personnel there appears, at least in Norway, no debate that it is very important to follow the developments in surface conditions and weather to achieve this objective. “If you don’t follow the developments, the runway starts to control you, instead of you controlling the runway” has been put forward. But to follow the surface conditions on an operative runway is far less plain and clear. It is practically impossible to monitor every square meter of pavement in a real-time manner. Nevertheless, maintenance personnel usually manage to keep roads and runways open. And as in any profession, there are individuals that clearly perform “above average” in their job. So what do these “experts” have above their colleagues? Is it more tacit knowledge? More practical experience and a better gut feeling? Very likely the answer is yes. But what does more experience or a better gut feeling imply? Maybe it implies (among other advantages) that “the experts” have a better understanding of the dynamical behaviour of the surface conditions. Maybe they perform better in creating a mental picture of the whole situation at the airport. Maybe they are better in identifying and interpreting the different signals and can better oversee

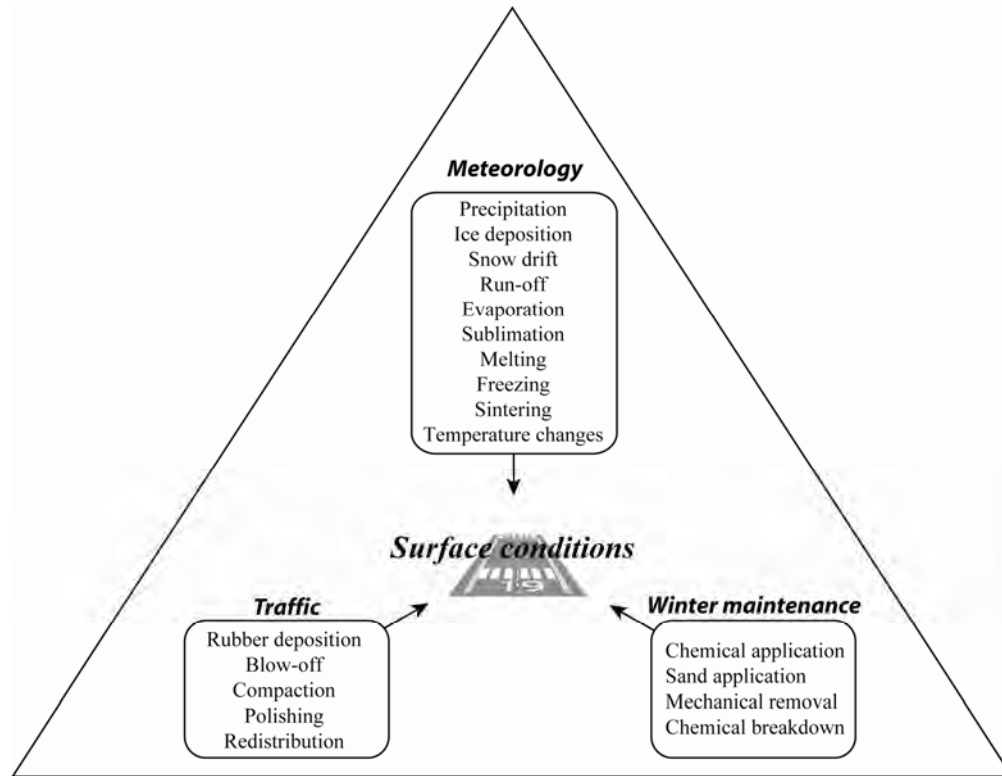

FIGURE 2 Conceptual model of processes that affect runway surface conditions.

how the surface conditions are developing. And maybe they understand better how their measures have an effect on this development. The conceptual model presented in Figure 2 can be viewed as an articulation of a small piece of their tacit knowledge into explicit knowledge. Such explicit knowledge is much easier to transfer in the form of formal education, and may help new maintenance personnel to develop their skills more rapidly.

The notion of 19 different processes is useful to get an overview of the dynamical behavior of runway surface conditions. Obviously, not all processes are operative simultaneously. For each process there are certain boundary conditions that determine whether the process is operative or not. For example, freezing only occurs when the air or pavement temperature is below the freezing point of the moisture on the pavement. Sintering only occurs when snow is present. The processes have different time scales. Freezing of a wet runway causes a significant change in surface conditions within minutes, whereas rubber deposition may take several months before it becomes noticeable. Probably the most important point in the conceptual model is the notion how weather, traffic, and winter maintenance are related to each other. They all affect the surface conditions by distinct physical processes. The model is not intended to give a ready answer to the daily questions such as “How good are the pavement surface conditions?” or “What kind of maintenance operation is required?” But it can be used to give maintenance personnel a simple notion on how surface conditions change and for this purpose it has been implemented in an education program of Norwegian airport winter maintenance personnel.

CONCLUSION

The dynamical behavior of runway surface conditions is described in nineteen physical processes. These processes were derived from direct observations and from analyzing information that was obtained from numerous conversations with Norwegian airport winter maintenance personnel.

ACKNOWLEDGMENTS

The author is very grateful to all the airport winter maintenance personnel that were willing to share their experiences. Unfortunately the number of persons involved is too large to name each person individually. The author is indebted to Armann Norheim, Avinor, Norway; Angelo Boccanfuso, Transportation Development Centre, Transport Canada, Canada; and Tore Hoven, Norwegian Public Road Administration, Norway for the financial support of this study. The author is also indebted to Nirmal Sinha, National Research Council Canada, Canada, for his guidance during the project. Special thanks go to Kai-Rune Lysbakken, Norwegian Public Road Administration, Norway, for the fruitful discussions and comments on the manuscript.

REFERENCES

1. ICAO. *International Standards and Recommended Practice, Annex 15 Aeronautical Information Services, Chapter 5 NOTAM*. 11th ed. International Civil Aviation Organization, 2003.
2. Biggs, D. C., and G. B. Hamilton. *Runway Friction Accountability Risk Assessment, Results of a Survey of Canadian Airline Pilots*. Publication TP 13941E. Transportation Development Centre, Transport Canada, 2002.
3. Nonaka, I., and H. Takeuchi. *The Knowledge-Creating Company: How Japanese Companies Create the Dynamics of Innovation*. Oxford University Press, New York, 1995.
4. Klein-Paste, A. *Runway Operability under Cold Weather Conditions—Tire/Pavement Friction Creation by Sand on Iced Pavements, and Non-Contacting Detection of Sand Particles on Pavements*. Ph.D dissertation. Publication Theses at NTNU, 2007:215, Norwegian University of Science and Technology, Trondheim, Norway, 2007.
5. Klein-Paste, A., and N. K. Sinha. *Airport Operations under Cold Weather Conditions—Observations on Operative Runways in Norway*. Publication TP 14648E. Transportation Development Centre, Transport Canada, 2006.
6. FAA. *Aircraft Winter Safety and Operation*. Publication AC 150/5200-30A, Federal Aviation Administration, 1991.
7. Klein-Paste, A., and N. K. Sinha. *Experiences with Warm, Prewetted Sanding at Airports in Norway*. Publication TP 14686E. Transportation Development Centre, Transport Canada, 2007.

WEATHER AND PAVEMENTS

The Pavement Precipitation Accumulation Estimation System**MARK A. ASKELSON***University of North Dakota*

Road maintenance personnel are responsible for keeping roads safe and thus plowing and chemically treating roads. In order to manage this activity, real-time information regarding where and how much precipitation has fallen is required. Our ability to determine these, however, is limited. Surface observation data are limited owing to lack of spatial and temporal densities and because few surface observation sites provide real-time information regarding wintertime precipitation accumulation. Radar data, on the other hand, provide much improved spatial and temporal coverage. These data, though, are limited because radar beams commonly overshoot winter precipitation systems and because radar-based precipitation estimates typically have greater errors than do surface observation-based estimates. Satellite data are limited by their temporal resolution and by the fact that they have not commonly been applied to relatively weak wintertime systems. In response to the need for road maintenance personnel for improved information regarding where and how much snow has fallen, the Pavement Precipitation Accumulation Estimation System (PPAES) has been developed. PPAES utilizes surface, radar, satellite, and model-analysis data and is designed to take advantage of the strengths of these data sets so as to provide as accurate information regarding wintertime precipitation occurrence and accumulation as possible. Specifically, this information is provided along roadways, where travelers and maintenance personnel need it most. PPAES design, development, and validation will be discussed. Emphasis will be placed on validation results for different PPAES modules, especially the satellite-based module. In addition, continuing development and future challenges will be considered.

Wintertime precipitation has serious impacts on surface vehicular transportation. It is estimated that adverse weather and associated adverse road conditions contribute to about 1,200,000 vehicular crashes that result in 800,000 injuries, 7,000 fatalities, and \$42 billion in economic costs each year (1). Of that, it was estimated from 1999 data that falling snow and sleet play a role in about 199,000 vehicle crashes that result in 63,000 injuries and 680 fatalities each year (2). Because falling snow- and sleet-related vehicle crashes comprise a significant percentage of the estimated total number vehicle crashes (199,000 of 1,200,000; 16.58%), injuries (63,000 of 800,000; 7.88%), and fatalities (680 of 7,000; 9.7%) resulting from adverse weather and associated adverse road conditions, it is obvious that the personal and economic tolls of wintertime precipitation impacts on surface transportation are high. Moreover, these percentages hold only for vehicle crashes in which snow or sleet was occurring at the time of the crash; they do not include vehicle crashes that resulted from previous wintertime precipitation that, for instance, may have deteriorated road conditions. Thus, these estimates of wintertime precipitation impacts on surface vehicular transportation, while significant, are low.

The purpose of this research is to provide highly accurate estimates of wintertime precipitation occurrence and accumulation on roadways. This information can benefit surface vehicular transportation through multiple avenues. The first is through providing high quality information regarding precipitation occurrence and accumulation and resulting pavement

conditions to travelers through intelligent transportation systems like 511 (3, 4). The second, and currently more active avenue, is through its utility in maintenance decision support systems (MDSSs), which support roadway maintenance decisions (5, 6). By both utilizing information regarding weather conditions, roadway characteristics, and maintenance standards of practice and applying physical models of relevant processes, MDSSs have the potential not only to improve traveler safety by enhancing roadway maintenance (and, thus, alleviate some of the losses discussed above), but also to decrease maintenance expenditures by improving management of roadway maintenance resources (e.g., chemicals used to melt snow). Experiences with roadway weather information systems, which comprise only one component of MDSSs, indicate that the potential to do both is significant (2).

Estimating wintertime precipitation occurrence and accumulation along roadways is a challenging task for multiple reasons. The first difficulty is in identifying where wintertime precipitation is occurring. As is described in the next section, no single observation platform (e.g., radar, surface observations, satellite) provides sufficient information to accurately determine the occurrence of wintertime precipitation. Consequently, a multisensor approach is needed. A second and more daunting difficulty is the impact redistribution of precipitation within the roadway environment has upon precipitation accumulation. Wintertime precipitation accumulation along roadways is strongly affected by winds, roadway topography (road height, ditch depth, surrounding hills, etc.), and vegetative cover. Because of the scope of this problem and the impacts blowing snow has on surface transportation, this is not considered here. Thus, this research is solely focused on the influx of precipitation into the roadway environment from aloft.

SOURCES OF DIRECT AND INFERRED PRECIPITATION INFORMATION

Significant effort has been expended in identifying data sources that can provide real-time information regarding wintertime precipitation occurrence and accumulation. The four main sources of information are surface observations, radar, satellite, and model and analysis data. Each of these data sources, as discussed subsequently, has significant limitations regarding identifying wintertime precipitation occurrence, the accumulation of wintertime precipitation, or both.

With surface observations, the principal limitation is scarcity. North Dakota (~183,477 km²), for instance, has approximately 25 surface observation stations (one every 7,339 km²) that report precipitation type in real time and approximately five surface observation stations (one every 36,695 km²) that provide real-time information regarding snowfall amounts. South Dakota (~200,129 km²), on the other hand, has approximately 50 (one every 4,003 km²) and 3 (one every 7,339 km²), respectively. For precipitation type, these numbers include ~11 ASOS/AWOS (automated surface observing system/automated weather observing system) and 24 environmental sensor stations (ESSs) in North Dakota and ~15 ASOS/AWOS and 35 ESSs in South Dakota. For snowfall amounts, these numbers reflect the number of manual intervention ASOS/AWOS stations in each state (Figure 1). However, it is not guaranteed that at even these few manual intervention stations snowfall amounts will be reported on an hourly basis. They may be reported on a 3-, 6-, or 24-h basis or not at all. While other observation networks do provide weather information, they either do not provide useful information regarding snowfall (e.g., the North Dakota Agricultural Weather Network; 7) or do not provide real time data (e.g., the National Weather Service Cooperative Observer Program 15-min precipitation network).

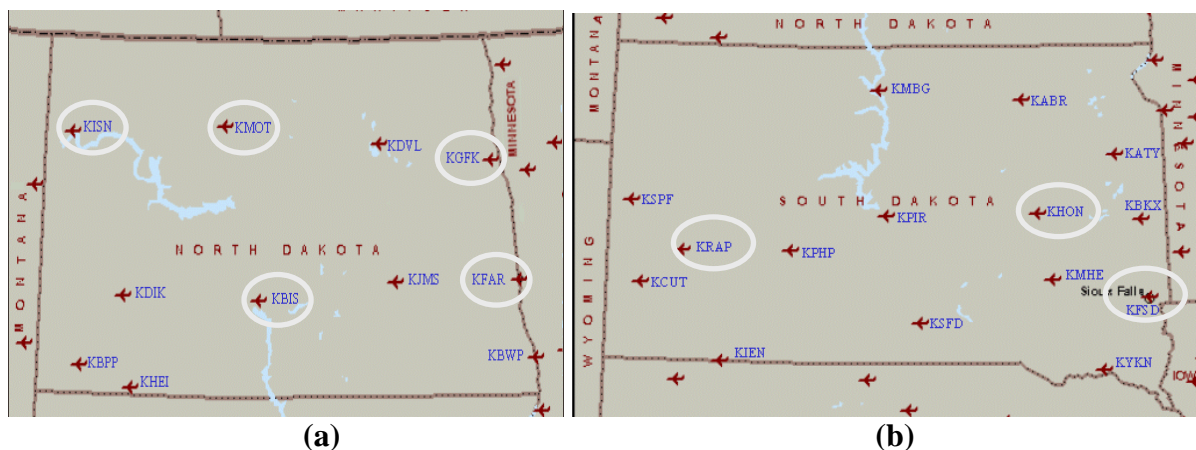

FIGURE 1 ASOS/AWOS stations in (a) North Dakota and (b) South Dakota. The circled stations are manual intervention stations.

Consequently, as stated by Super and Holroyd (8), the existing surface observation network is inadequate for the real-time estimation of snowfall. Because the number of surface observation stations that provide information regarding precipitation occurrence is much larger, however, the existing surface observation network is useful for identifying precipitation occurrence and type.

Because of the limited utility of surface observations, remote sensing instruments are quite important to determining wintertime precipitation occurrence and accumulation over large areas. One of the most useful remote sensing instruments is radar, which provides excellent information regarding the spatial and temporal distribution of wintertime precipitation. Radar, however, also has limitations. The two primary limitations are (1) inaccuracies in radar-provided estimates of snowfall and (2) overshooting of precipitation (Figures 2 and 3). This second limitation is quite significant and, in fact, contributes to the first limitation. Figure 2 is a simple schematic that illustrates this problem in its extreme. As electromagnetic pulses emitted from radars travel away from their source, their height relative to the Earth's surface tends to increase. Consequently, for storms that are located far from a radar, pulses can completely overshoot them. In such a situation, a radar incorrectly indicates that no precipitation is falling. This problem is more severe for wintertime precipitation than for summertime precipitation because the vertical extent of wintertime precipitation is oftentimes less (8, 9). Consequently, this presents a significant problem for the determination of wintertime precipitation occurrence for locations far from radars. An example of such a situation is shown in Figure 3a, which provides liquid-water-equivalent precipitation rates produced using the radar-based algorithms developed in this study. In this figure, arcing circles that demarcate precipitation occurrence are especially apparent around the Mayville, North Dakota; Aberdeen, South Dakota; Minneapolis, Minnesota; and Des Moines, Iowa, radars. Because the height of radar pulses depends primarily on distance from the radar, these arcs are likely indicative of the range at which pulse height becomes large enough to overshoot the precipitation; it is highly unlikely that this event had precipitation shields that were this symmetric and centered on these radars.

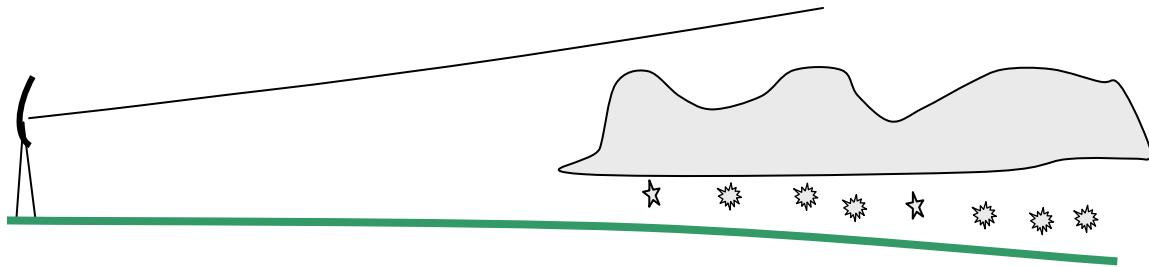

FIGURE 2 Simple schematic illustrating the radar overshoot problem. With distance from the radar (left side of schematic), the radar beam (black line) rises relative to the Earth’s surface (green line), resulting in overshooting of the precipitating system (right side of schematic).

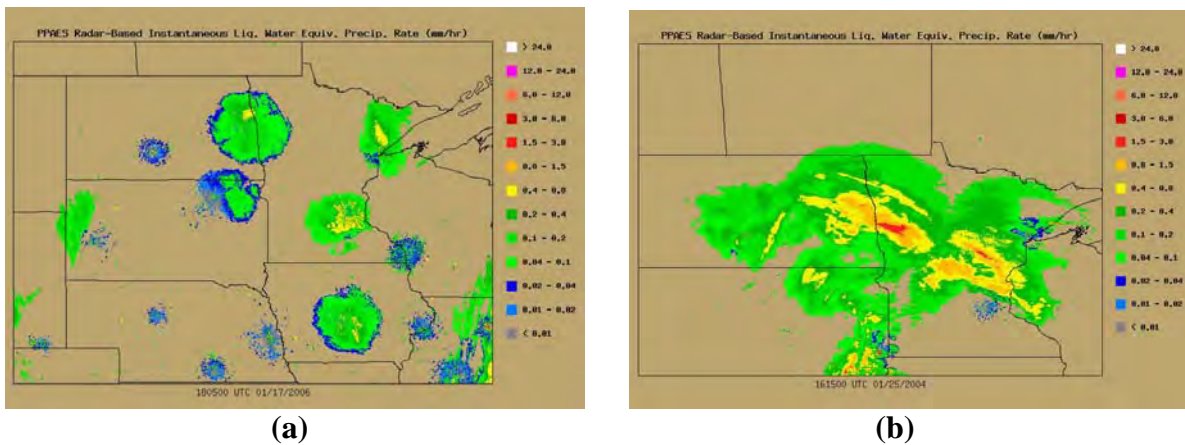

FIGURE 3 Examples of limitations of radar data for estimating snowfall: (a) liquid–water–equivalent precipitation rates at 1805 UTC (coordinated universal time) (12:05 p.m. CST) on January 17, 2006, for a light snow event that affected a large portion of the northern plains and (b) liquid–water–equivalent precipitation rates at 1615 UTC (10:15 a.m. CST) on January 25, 2004, for a snowstorm that affected the northern plains.

Figure 3b provides an illustration of inaccuracies in radar-provided estimates of snowfall. In this figure, an intense snow band stretches southeast from eastern North Dakota to western Wisconsin. A weak “spot” in this snow band is present in west-central Minnesota. Because this location is significantly far away from the Mayville, Aberdeen, and Minneapolis radars, it is very likely that this area of lighter estimated precipitation is errant and, in fact, is caused by radar pulses returning information from relatively high in the precipitating system back to the radars. Snow producing systems typically have precipitation rates that are highest very near the ground and that decrease significantly with height (8). Consequently, at locations farther away from radar, radar-derived precipitation estimates are oftentimes too low. This issue becomes significant at modest ranges; Super and Holroyd (8) found that radar-derived precipitation estimates for snowfall

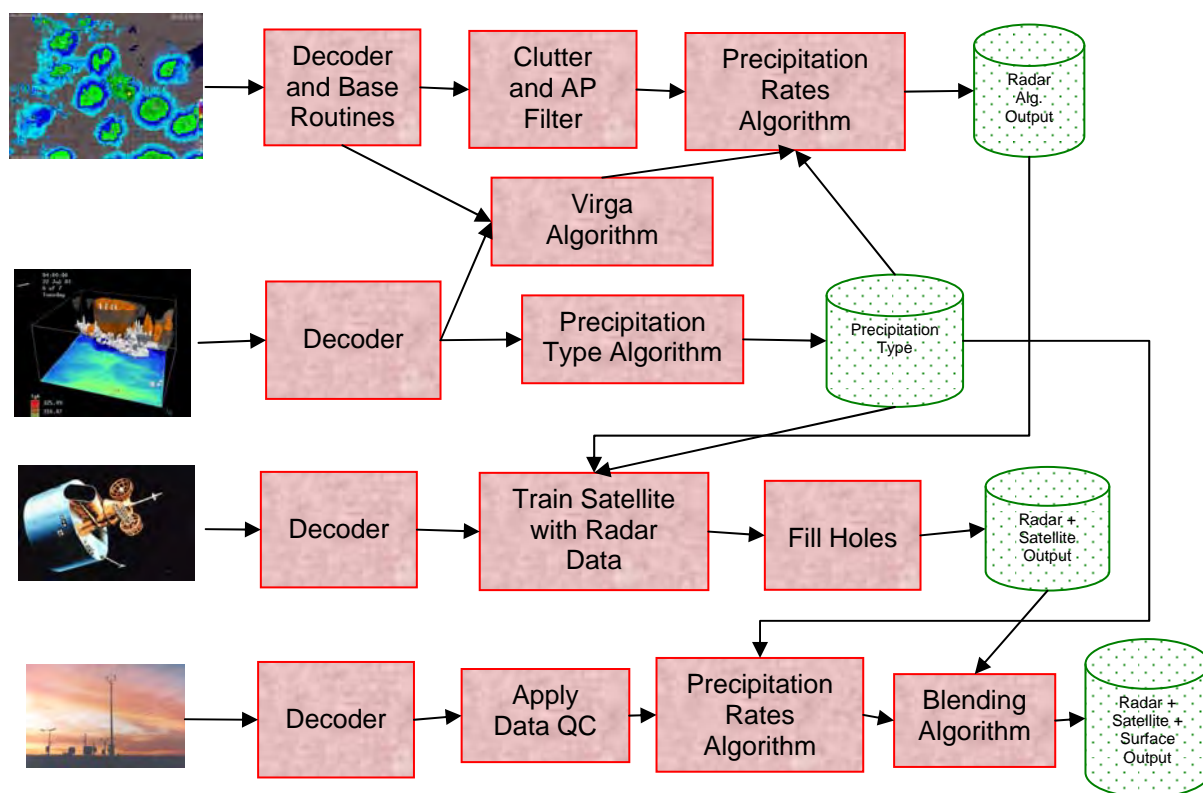

FIGURE 4 PPAES Schematic. The leftmost column of images represents different data types used in PPAES (from top to bottom: radar, model-analysis, satellite, and surface). The text boxes identify major tasks associated with each data source, and the cylinders indicate milestones.

tended to be too low at locations greater than about 70 km from a radar. Moreover, beyond about 140 km, they found that the use of radar data alone resulted in severe (radar-observed precipitation ratios < 0.2) underestimates.

The use of satellite data is also complicated because satellite data suffer from inaccuracies that tend to be greater than those associated with radar data and because the use of satellite data for such a purpose is much less proven. Satellite data have been used to identify cloud patterns that can be related to heavy snow bands [e.g., Johnston (10)] and to estimate precipitation rates [e.g., Chen and Staelin (11)]. However, neither of these approaches is of great utility here because both precipitation occurrence and amount are needed, not just characteristics of heavy snow bands, and because real time information is needed, which means that data from polar orbiting satellites, which are updated every 3 h and were used by Chen and Staelin (11), are not timely enough.

The final major data source is analysis-model data. This data source provides information regarding temperature and moisture fields, which can be used to estimate precipitation type and to identify areas where virga, which is precipitation that does not reach the ground, is occurring. The former is critical to determining impacts on visibility, precipitation accumulation, and road condition, while the latter is important in avoiding errantly indicating that precipitation will impact roadways when precipitation is not reaching the surface.

PPAES DESIGN AND DEVELOPMENT

In order to provide highly accurate estimates of wintertime precipitation occurrence and accumulation, the Pavement Precipitation Accumulation Estimation System (PPAES) has been developed. PPAES is designed to leverage the strengths of numerous sources of information to estimate wintertime precipitation occurrence and accumulation (Figure 4). The reason for this is that each individual information source, as discussed previously, has significant limitations. Thus, PPAES is designed to take advantage of the excellent information regarding precipitation extent and structure provided by radar data, to fill coverage holes using satellite data, to diminish errant indications of precipitation occurrence using surface data, and to delineate precipitation types and identify regions of virga using model–analysis data.

The major components of the radar processing routines are complete. These include data decoding, clutter and anomalous propagation artifact removal, mosaicing, precipitation rate estimation, and input–output. Of particular note are the clutter and anomalous propagation artifact removal software, which follows a fuzzy logic-based approach described by Kessinger et al. (12), and the precipitation rate estimation, which follows Super and Holroyd (8) and Holroyd (13).

Real-time execution and processing routines have also been developed for the radar data processing chain. These routines, together with the data processing routines, have been used to produce real time liquid-water-equivalent precipitation rate estimates across the pooled-fund study (PFS) MDSS area (5) during the 2005–2006, 2006–2007, and 2007–2008 winter seasons. Graphics for this product (and subsequently described products) are provided in real time online at <http://stwrc.und.edu/graphics/ppaes/>. Both the data processing routines and real-time execution and plotting routines have been extensively tested and are stable and robust.

Another area of significant effort was the development of an algorithm for estimating precipitation type. The first step in this was the identification of the data set/information source for doing so. Because precipitation type can evolve rapidly, especially in stormy conditions, a data set that is rapidly updated is desired. Moreover, the type of precipitation that reaches the ground generally depends upon two things: (1) the starting state of the precipitation and (2) the amount of melting–freezing the precipitation experiences during descent to the ground (14). Consequently, a data set that provides information regarding precipitation type has to yield information regarding temperature, pressure, etc., through a vertical column of the atmosphere such that the amount of melting–freezing during descent can be evaluated. Because of these requirements, rapid update cycle (15) analyses were chosen as the precipitation-type data set. This data set has the advantages of being updated hourly, of providing detailed information regarding the vertical thermodynamic structure (pressure, temperature, etc.) of the atmosphere, and of providing relatively high resolution (~20 km horizontal grid spacing) information. Moreover, these are analyses and not forecasts and, thus, should provide more accurate information regarding atmospheric conditions.

The second step in developing a precipitation-type algorithm was the selection of the algorithm. Numerous methods exist (16, 17). For PPAES, the Bourgoïn method (17) is used because of its relative simplicity. The Bourgoïn method takes advantage of the fact that precipitation type depends upon beginning type and amount of melting–freezing that occurs during descent. It then utilizes a sounding classification scheme wherein soundings are parsed according to whether (1) there are temperatures below freezing within the sounding, (2) whether an above-freezing layer exists next to the ground, (3) whether an elevated above-freezing layer exists, and (4) whether an elevated below-freezing layer is sandwiched between two above-

freezing layers with one above-freezing layer located next to the ground. Each of these sounding types tends to produce different types of precipitation depending upon how much melting–freezing can occur within layers. The task, then, is to determine which type of sounding is present and estimate the amount of melting and freezing that can occur in relevant layers (the positive and negative areas in the layers). In concept, this is a fairly straightforward approach that Bourgoiuin (17) showed is quite effective.

The implementation of the Bourgoiuin algorithm (17), however, is more complicated than is implied by its relatively straightforward approach. This is attributable to special exceptions to the situations outlined by Bourgoiuin. In essence, Bourgoiuin does not list all possible sounding types and, thus, ones that do not conform to those discussed by Bourgoiuin must be handled through special processes. All of these situations were identified through the code development and testing stages. Consequently, the precipitation type algorithm is stable and robust.

For utilization during the 2006–2007 and 2007–2008 winters, display software was developed so that precipitation-type output could be utilized easily and Perl scripts were developed so that the precipitation-type algorithm could be utilized to produce real-time information regarding expected precipitation types. These were used, along with the precipitation-type code, to produce real-time precipitation-type analyses and maps throughout the 2006–2007 and 2007–2008 winters. An example is shown in Figure 5.

Another major area of development was the satellite algorithm. The idea is to fill in gaps in precipitation fields that owe to radar overshoot, a striking example of which is shown in Figure 3. To accomplish this, geostationary operational environmental satellite cloud top pressure data near a radar are correlated to liquid–water–equivalent precipitation rates estimated using that radar’s data. The result is a linear relationship between cloud top pressures and liquid–

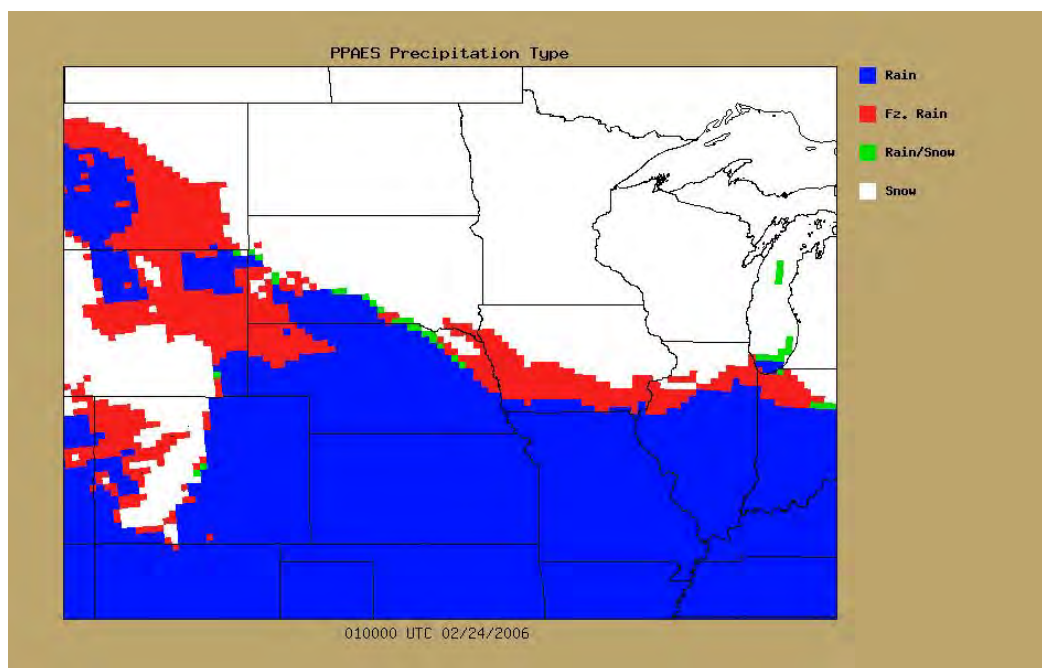

FIGURE 5 An example of output from the PPAES precipitation-type algorithm.

water-equivalent precipitation rates (forms other than linear were considered but examination of the data revealed that their use was not justified). The derived linear relationship is then used to fill in precipitation in areas where the radar did not observe precipitation (presumably because it overshot the precipitation). This hole filling is performed within a limited distance of a particular radar because presumably the relationship between cloud top pressure and liquid-water-equivalent precipitation rate would be regional. Moreover, hole filling is performed only in locations where snow is expected since this is the precipitation type for which overshooting is expected to be a dominant issue. Consequently, in addition to PPAES radar output, PPAES precipitation-type output is also utilized in the satellite algorithm. [Examples of output from the satellite algorithm are provided in [Figures 7](#) (radar) and [8](#) (radar+satellite).]

Development of surface processing routines is currently in progress. Because of the previously discussed issues associated with using direct measurements of snowfall rates and amounts obtained with surface observation platforms, surface visibility observations are being used for this purpose. Visibility can be used as a proxy for snowfall rate, although errors can commonly be greater than 50% (18). While significant, this is an improvement over the alternative, which is practically no information regarding real-time snowfall rates from surface observation platforms.

Software for decoding surface data is complete, with software for converting visibility values into precipitation rates (18), for discriminating blowing snow from falling snow, for distributing estimated precipitation rate values, and for fusing analyses with other products (radar and satellite) under development. Because visibility is affected when blowing snow is present, blowing snow presents a significant source of error for this algorithm. Consequently, this algorithm will utilize both the precipitation-type sensor data provided by many surface observation platforms and a relationship between required wind speed and temperature for blowing snow production (19) to ameliorate this problem. In situations where both blowing and falling snow are occurring, surface estimates will not be produced and values will be obtained from radar and satellite data.

Two goals with PPAES are (1) to provide information regarding the areal extent of precipitation to enable users to rapidly understand precipitation extent and evolution so as to utilize this information for decision making (maintenance, travel, etc.) and (2) to provide information regarding precipitation along roadways since this is where this information is needed the most. Currently, two routines exist for obtaining precipitation along roadways. One extracts this information from output files produced using the PPAES radar software and the other extracts this information from output files produced using the PPAES satellite software. Both of these utilize shapefiles that contain geospatial information regarding PFS MDSS test routes. The information extracted with both is liquid-water-equivalent instantaneous precipitation rate. The extraction technique utilized is simply direct extraction of values from the grid. This results in a blocky appearance to the values, as illustrated in [Figure 6](#). However, it also provides the most faithful representation of the data as they exist in these analyses. To strike a compromise between the two, spline interpolation, which enables one to control the amount of smoothing and, thus, the degree of distortion of the data trace, may be applied in the future. Spline interpolation is very well suited to this problem.

Most of the PPAES software set has been developed and extensively tested for robustness. This software has been used over the 2005–2006, 2006–2007, and 2007–2008 winters to produce real-time liquid-water-equivalent precipitation rate estimates and precipitation type estimates.

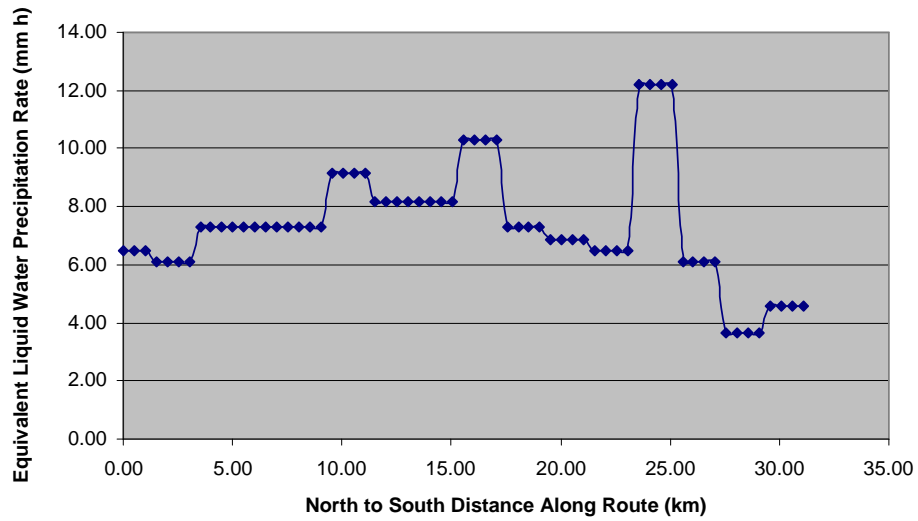

FIGURE 6 An example of liquid–water–equivalent precipitation rates extracted along the I-29 PFS MDSS route in North Dakota from a PPAES radar output file.

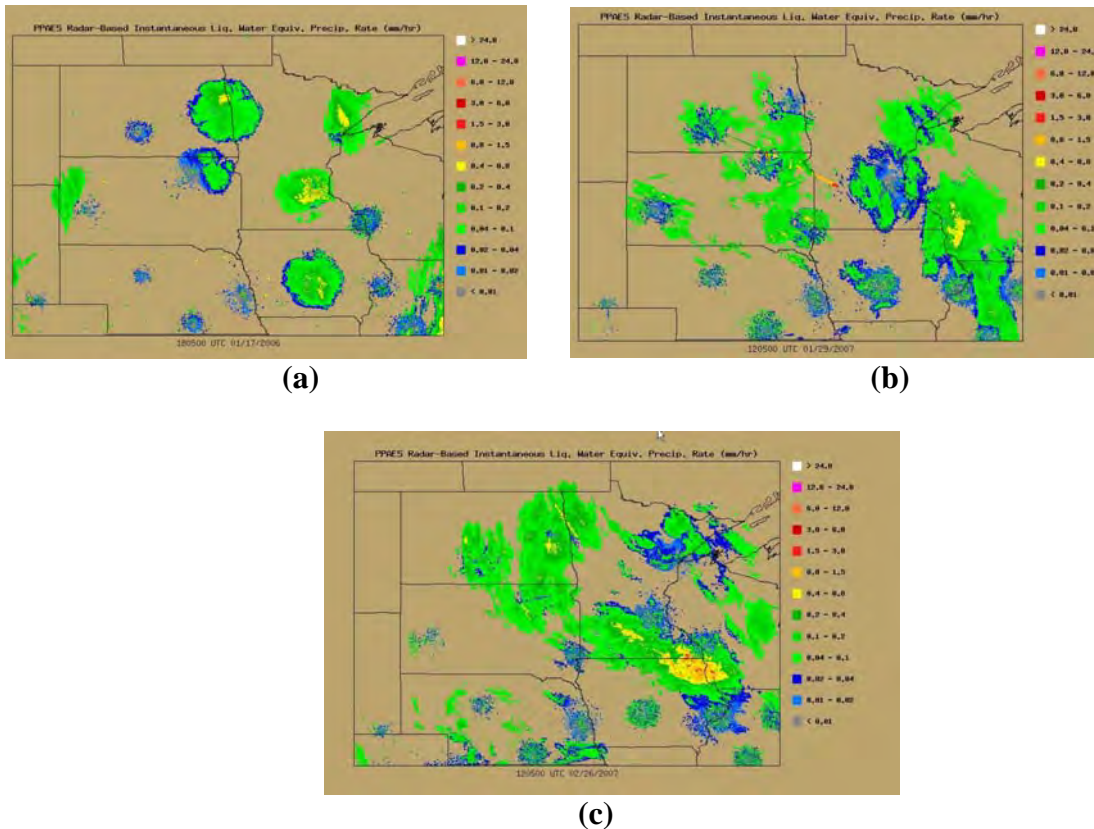

FIGURE 7 Liquid–water–equivalent instantaneous precipitation rates estimated using PPAES radar routines for (a) 18 UTC January 17, 2006; (b) 12 UTC January 29, 2007; and (c) 12 UTC February 26, 2007.

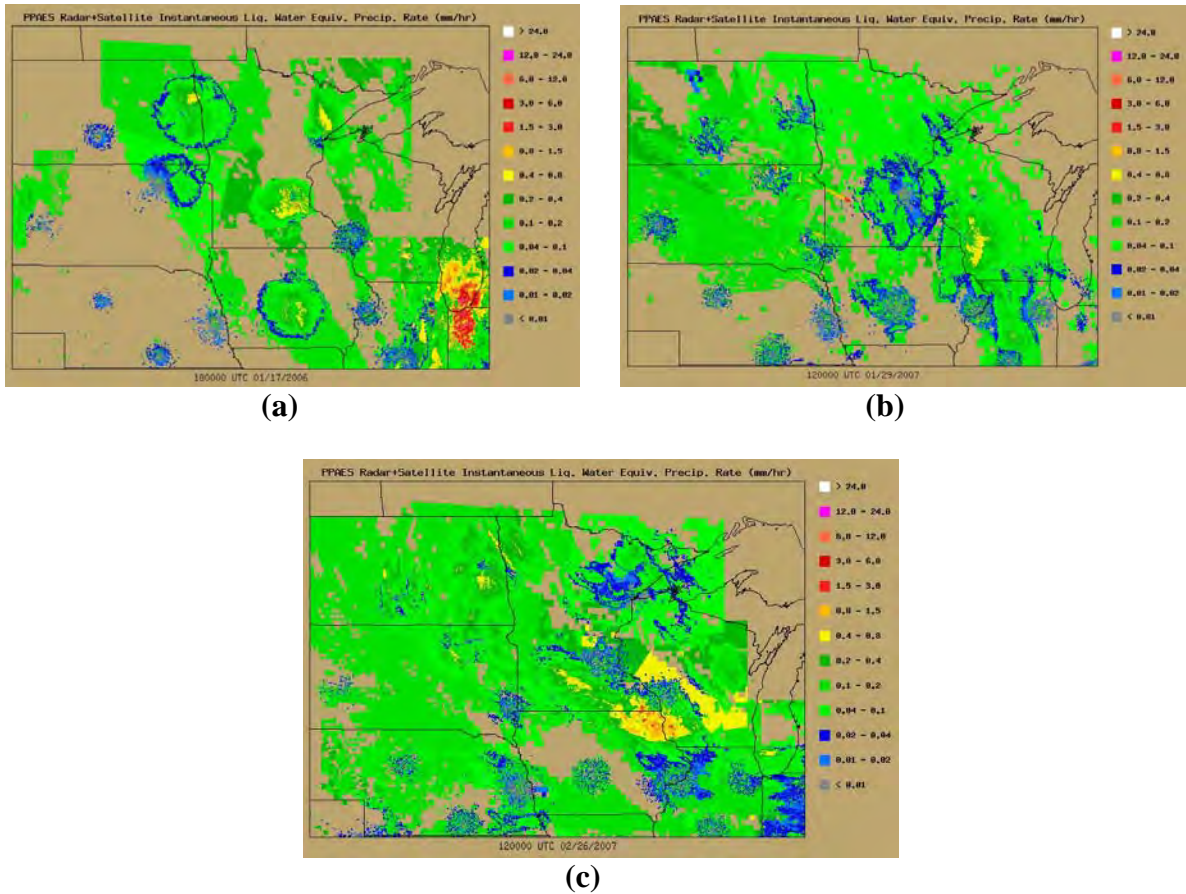

FIGURE 8 As in Figure 7, except with instantaneous precipitation rates estimated using the PPAES satellite algorithm.

VERIFICATION AND VALIDATION

PPAES snowfall occurrence performance has been tested using ASOS/AWOS precipitation occurrence data. Three events were studied: January 17, 2006; January 29, 2007; and February 26, 2007. PPAES radar-based liquid–water–equivalent instantaneous precipitation rates for the times studied are provided in Figure 7. The first two events were chosen because they show clear indications of severe radar overshoot problems. In the January 17, 2006, case, for instance, “circles” are present around North Dakota, Minnesota, and Iowa radars. In the January 29, 2007, case, “circles” are present around North Dakota and South Dakota radars. The third case was chosen specifically because it did not show obvious signs of radar overshoot problems.

PPAES satellite-based liquid–water–equivalent instantaneous precipitation rates that correspond to the images in Figure 7 are provided in Figure 8. As is evident by comparing these figures, issues exist where radar data and satellite data merge. Specifically, discontinuities can arise in the figures (e.g., west-central Minnesota in Figure 8a). While not visually pleasing, these discontinuities are not terribly detrimental to data quality. Furthermore, they can easily be alleviated by smoothing the data.

The more pressing concern is the rather broad regions over which the satellite algorithm produces precipitation estimates. While this is a desired effect in that radar overshoot results in an indication of precipitation over a smaller region than that over which it occurs, the compensation for this with the satellite algorithm appears to be too strong. In Figure 8c, for instance, snow is indicated to be occurring over nearly the entire region, which does not seem likely. Consequently, it appears as if the satellite algorithm tends to overproduce snowfall.

To test whether the satellite algorithm does overproduce snowfall, standard skill scores were computed for the events pictured in Figures 7 and 8. While numerous skill scores were computed, only hit rate and equitable threat score will be considered here. The hit rate provides information regarding how well an event is detected, with zero being the worst possible score and 1 being the best possible score. The equitable threat score is a composite score that indicates skill by rewarding hits (event forecasted and event occurred) and correct negatives (event not forecasted and did not occur) while penalizing misses (event not forecasted and occurred) and false alarms (event forecasted and did not occur). As with the hit rate, 1 is a good score while values near zero (they can be negative) indicate little skill.

Hit rates for the three events are illustrated in Figure 9. As indicated in this figure, the PPAES satellite algorithm generally outperformed the PPAES radar algorithm regarding the hit rate. This is to be expected as the satellite algorithm significantly expands the region over which snow is believed to be occurring and, thus, should hit actual occurrences more often.

A more stringent test of performance, however, is given by the equitable threat score, values for which are shown in Figure 10. In contrast to the situation with the hit rate, the PPAES radar algorithm generally outperformed the PPAES satellite algorithm with regard to the equitable threat score. Given the hit rate performances, the reason for these relatively equitable threat performances is that the satellite algorithm is too aggressive in its expansion of the snowfall area. This results in many false alarms that bring the equitable threat scores of the PPAES satellite algorithm down even though the hit rates of the PPAES satellite algorithm are higher than those of the PPAES radar algorithm.

Consequently, the false alarm rate of the PPAES satellite algorithm is too high. This is not unexpected, however. In fact, the PPAES satellite algorithm was designed with the purpose of restricting its snowfall area by utilizing surface data and output from the virga algorithm. As those algorithms are still under development, testing of this is a future task.

The remaining validation and verification task involves wintertime precipitation accumulation. Data collected at the Surface Transportation Weather Research Center's Road Weather Field Research Facility (RWFRF; 20) have been used to compare to liquid-water-equivalent snowfall accumulations produced by the PPAES radar algorithm. As the RWFRF is 21.53 km northeast of the Mayville, North Dakota, WSR-88D (Weather Service Radar 88 Doppler) radar, it is in an excellent location to test the performance of PPAES radar algorithms. To date, snowfall accumulation verification statistics have been computed for the 2005–2006 winter season, which involved 11 events (data from the 2006–2007 winter season are currently being analyzed). During the 2005–2006 winter season, snow boards (treated as ground truth), an unshielded Geonor gauge (21), and a Yankee hotplate (22) were operated at the RWFRF. Unfortunately, the Yankee hotplate experienced a malfunction and consequently suffered an average relative error of 386% (values were always high). The Geonor, which functioned properly, also suffered significant errors owing to the lack of shielding and the consequent wind impacts with an average relative error of 76% (values were always low). The PPAES radar algorithm, on the other hand, suffered an average relative error of only 43%. These results

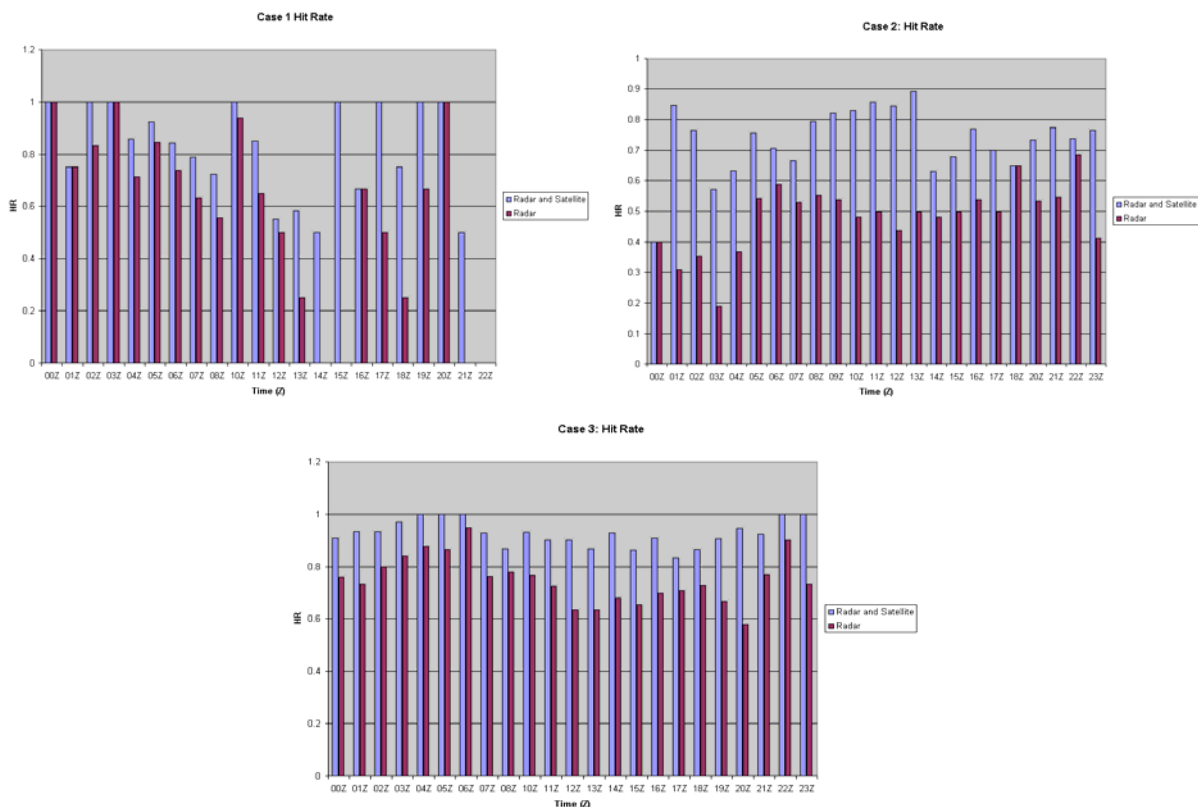

FIGURE 9 Hit rates for January 17, 2006 (Case 1); January 29, 2007 (Case 2); and February 26, 2007 (Case 3). Values for the PPAES radar algorithm are shown in red and for the PPAES satellite algorithm are shown in blue.

underscore the difficulty of accurately measuring snowfall using automated systems, with the radar-based algorithm actually outperforming the in situ sensors. During the 2006–2007 winter, the Yankee hotplate operated correctly and a shielded Geonor gauge was utilized. Consequently, the 2006–2007 results will provide excellent information for snowfall measurement comparison purposes.

CONCLUSION

Individual observation platforms are significantly limited in their ability to measure snowfall. Consequently, a multiplatform approach like that undertaken with PPAES is required. PPAES is maturing, with final components currently under development. Even upon maturing, although PPAES is likely to provide a significant improvement in snowfall and precipitation monitoring capabilities that will enhance information provided to travelers and maintenance operations, significant challenges in monitoring snowfall will remain.

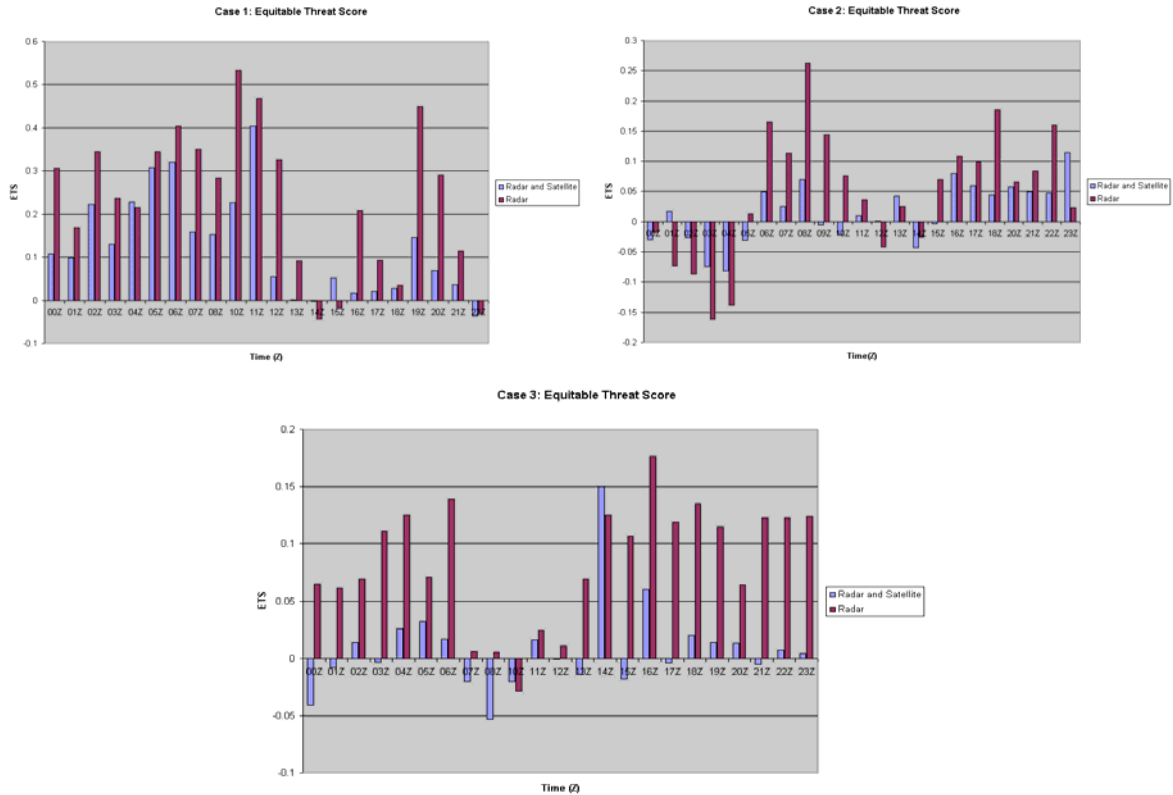

FIGURE 10 As in Figure 9 except for the equitable threat score.

ACKNOWLEDGMENTS

The author thanks Shannon Murphy for her work on the verification of the PPAES satellite algorithm—especially for her production of Figures 9 and 10. This work is supported under Federal Highway Administration’s Sponsored Research Program Funds through the North and South Dakota Departments of Transportation.

REFERENCES

1. *Overview of U.S. Crashes and Weather Environment*. Office of the Federal Coordinator for Meteorology, Weather Information for Surface Transportation 2, www.ofcm.gov/wist2/presentations/day2/5_panel4a/2_lombardo.ppt. Accessed November 29, 2007.
2. Office of the Federal Coordinator for Meteorological Services and Supporting Research. *Weather Information for Surface Transportation: National Needs Assessment Report*. FCM-R18-2002, OFCM, 2002.
3. *511 America’s Traveler Information Telephone Number*. U.S. Department of Transportation—Federal Highway Administration, www.fhwa.dot.gov/trafficinfo/511.htm. Accessed November 29, 2007.
4. *511 History*. North Dakota Department of Transportation, www.dot.nd.gov/divisions/maintenance/511_history.htm. Accessed November 30, 2007.

5. *Maintenance Decision Support System—Pooled Fund Study*. Meridian Environmental Technology, Inc., <http://mdss.meridian-enviro.com/pfs/>. Accessed November 29, 2007.
6. *Maintenance Decision Support System (MDSS)*. National Center for Atmospheric Research—Research Applications Laboratory, www.rap.ucar.edu/projects/rdwx_mdss/. Accessed November 29, 2007.
7. *North Dakota Agricultural Weather Network*. North Dakota State University, <http://ndawn.ndsu.nodak.edu/index.html>. Accessed November 30, 2007.
8. Super, A. B., and E. W. Holroyd III. *Snow Accumulation Algorithm for the WSR-88D Radar: Final Report*. Bureau of Reclamation Rep. R-98-06, 1998.
9. Joss, J., and R. Lee. The Application of Radar-Gauge Comparisons to Operational Precipitation Profile Corrections. *Journal of Applied Meteorology*, Vol. 34, 1995, pp. 2612-2630.
10. Johnston, E. C. Updated Satellite Technique to Forecast Heavy Snow. *Weather and Forecasting*, Vol. 10, 1995, pp. 219-228.
11. Chen, F. W., and D. H. Staelin. AIRS/AMSU/HSB Precipitation Estimates. *IEEE Transactions on Geoscience and Remote Sensing*, Vol. 41, 2003, pp. 410-417.
12. Kessinger, C., S. Ellis, J. V. Andel, J. Yee, and J. Hubbert. The AP Ground Clutter Mitigation Scheme for the WSR-88D. *Extended Abstracts, 21st Conference on Interactive Information Processing Systems for Meteorology, Oceanography, and Hydrology*, San Diego, Calif., American Meteorological Society, 2005.
13. Holroyd, E. W., III. *Snow Accumulation Algorithm for the WSR-88D Radar: Supplemental report*. Bureau of Reclamation Rep. R-99-11, 1999.
14. Rogers, R. R., and M. K. Yau. *A Short Course in Cloud Physics*. Pergamon Press, 1991.
15. RUC-NOAA/ESRL/GSD. National Oceanic and Atmospheric Administration Earth System Research Laboratory Global Sciences Division, <http://maps.fsl.noaa.gov/>, Accessed 1 December 2007.
16. Baldwin, E. B., and S. P. Contorno. Development of a Weather-Type Prediction System for NMC's Mesoscale ETA Model. *Preprints, 13th Conference on Weather Analysis and Forecasting*, Vienna, Va., American Meteorological Society, 1993, pp. 86-87.
17. Bourgoquin, P. A Method to Determine Precipitation Types. *Weather and Forecasting*, Vol. 15, 2000, pp. 583-592.
18. Rasmussen, R. M., J. Vivekanandan, J. Cole, B. Myers, and C. Masters. The Estimation of Snowfall Rate Using Visibility. *Journal of Applied Meteorology*, Vol. 38, 1999, pp. 1542-1563.
19. Li, L., and J. W. Pomeroy. Estimates of Threshold Wind Speeds for Snow Transport Using Meteorological Data. *Journal of Applied Meteorology*, Vol. 36, 1997, pp. 205-213.
20. *Surface Transportation Weather Research Center*, University of North Dakota Regional Weather Information Center, <http://stwrc.und.edu/fieldsite/live/index.php>, Accessed 29 November 2007.
21. GEONOR. GEONOR, Inc, http://www.geonor.com/meteorological_catalog.html. Accessed December 1, 2007.
22. *TPS-31 Hotplate (Total Precipitation Sensor)*. Yankee Environmental Systems, Inc., www.yesinc.com/products/data/tps3100/index.html. Accessed December 1, 2007.

WEATHER AND PAVEMENTS

Temperature and Precipitation Sensitivity Analysis on Pavement Performance

JAMES T. SMITH

SUSAN L. TIGHE

JEAN ANDREY

University of Waterloo

BRIAN MILLS

Meteorological Service of Canada, Environment Canada

It is estimated that the average temperature in Canada will increase between 2°C and 5°C and precipitation will increase 0% to 10% over the next 45 years. These changes in climate will impact pavement performance and this paper attempts to predict the consequences of this performance change. Using Canadian data from the Long-Term Pavement Performance program, the *Mechanistic-Empirical Pavement Design Guide* (M-E PDG) version 1.0 is used to quantify the impact of climate change in the Canadian environment. In essence, two case studies representing Canadian conditions are presented. Specifically, how climate changes in precipitation and temperature affect the pavement performance indicators of International Roughness Index, longitudinal cracking, transverse cracking, alligator cracking, asphalt concrete deformation (rutting), and total rutting is assessed. Simulations were performed with combinations of 0%, -5%, +5%, +10% and +25% precipitation changes and 0°C, +1°C, +2°C, and +5°C temperature increases. Temperature increases have a negative impact on the pavement performance in the Canadian environment. Maintenance, reconstruction, and rehabilitation (MR&R) activities would be minimally affected with a 1°C increase in temperature. Based on the initial analysis, Canadian transportation agencies would likely not change MR&R activities until a 2°C or higher increase in temperature. The M-E PDG was not sensitive enough to distinguish between changes in precipitation or changes in transverse cracking. The CGC M2A2x and HadCM3B21 detailed climatic scenarios provide realistic prediction of the changes in pavement performance due to increases in temperature and precipitation.

Canada's road infrastructure has an estimated value of \$150 billion (1). This infrastructure enables transportation of people and resources, which is a major source of our economic prosperity. It is generally accepted that climate impacts pavement performance; however, in the past it has been difficult to quantify this impact. Earlier design methods accounted for climate by categorizing into a broad climatic region (i.e., wet-freeze, wet-no freeze, dry-freeze, dry-no freeze). In general, the temperature is increasing due to an increase in greenhouse gases in the atmosphere. For the majority of Canada, the average temperature is estimated to increase by 2°C to 5°C and the average precipitation is estimated to increase from 0% to 10% over the 45 years period from 1985 to 2050 (2). Further developing the relationship between climate and pavement performance will enable the development of better pavement designs and maintenance, reconstruction, and rehabilitation (MR&R) processes.

PROJECT OBJECTIVES

This paper investigates the impact of climate change in the Canadian environment on pavement performance over a 20-year period using the *Mechanistic–Empirical Pavement Design Guide* (M-E PDG). Specifically, how climate changes in precipitation and temperature affect the pavement performance indicators of international roughness index (IRI), longitudinal cracking, transverse cracking, alligator cracking, asphalt concrete (AC) deformation, and total deformation is assessed.

M-E PDG

The development of M-E PDG began in 1997 by the AASHTO Joint Task Force on Pavements under NCHRP Projects 1-37 and 1-37a (3). The ability to develop the M-E PDG came through advancements in computers, modeling technologies, vast amounts of pavement performance data available through the SHRP and Long-Term Pavement Performance (LTPP) programs, and more rigorous pavement design procedures (4). The M-E PDG applies validated, state-of-the-practice technologies, which allow the pavement designer to consider a wide variety of design and material options. The M-E PDG version 0.8 was used to conduct the analysis.

Current research being conducted on the M-E PDG includes: how changes in the material and traffic input data affect the performance sensitivity, implementation of the M-E PDG, calibration of the M-E PDG to match field data, and the impact of climate. Climatic issues that have been looked at include: estimating moisture content within the pavement structure, the effects of different drainable base materials, the effects of ground water depth, and the accuracy of the Enhanced Integrated Climatic Model (EICM).

The M-E PDG simulates both new and rehabilitation designs at three input levels (4). Level 1 obtains the highest degree of accuracy by using specific site and material information. Level 2 uses values similar to the AASHTO design guides (4). Level 3 uses the national average default values based on data taken from Long-Term Pavement Performance program (LTPP) in 2000. Mechanistic results of stress and strains are used to estimate pavement distress, whereas empirical results are used when data are calibrated to observed performance (5).

The M-E PDG requires data for traffic, structure and material properties, and climate to give the level of performance. The EICM is used within the M-E PDG to better examine the impact of climate. The EICM is a combination of the climatic–materials–structural model the rainfall, infiltration, and drainage (ID) model; and the U.S. Army Cold Regions Research and Engineering Laboratory frost heave and thaw settlement model (3). Hourly climatic data are entered into the EICM section of the M-E PDG using imperial units.

TEST SITES

Two Canadian test sites from the LTPP program were used; Alberta (81-1804) and Ontario (87-1806). These sites were chosen because they are representative of two different climatic regions and they contained sufficient data to run the simulations. Traffic data and the structure and material properties were extracted from the LTPP database for both test sites. Table 1 gives a description of the test sites. The M-E PDG defaults were used for the performance criteria.

TABLE 1 Test Site Information

	Alberta	Ontario
LTPP Site Identification *	81-1804	87-1806
Climatic region	Dry-freeze	Wet-freeze
Latitude (degree.minutes)	53.57	43.4
Longitude (degree.minutes)	-113.52	-79.35
Elevation (m)	670	175
2-way AADTT **	1420	2744
Trucks in design lane (%)	100	100
Pavement structure		
Asphalt (mm)	85	40
Asphalt (mm)	—	100
Base (mm)	325	180
Subbase (mm)	245	790
Pavement material		
Base	Crushed gravel	Crushed gravel
Subbase	River-run gravel	A-4
Subgrade	SM	ML

* LTPP = long-term pavement performance

** AADTT = average annual daily truck traffic

CLIMATIC FILE DEVELOPMENT

Since Canadian climatic files were not available to use with the M-E PDG, climatic data over a 15-year timeframe (1990–2005) were provided by Environment Canada. Data for temperature, wind speed, percent sunlight, precipitation, and relative humidity were gathered to produce the hourly climatic data (HCD) files. The data for temperature, wind speed, percent sunlight, and relative humidity were provided on an hourly basis. Data for precipitation were provided on a 6-h basis (00:00–06:00, 06:00–12:00, 12:00–18:00, and 18:00–00:00).

The M-E PDG requires precipitation data input on an hourly basis. Since actual precipitation data was provided in 6-h windows, a test was done to see if allocating the precipitation differently within the 6-h window would affect the results. The M-E PDG was run using the Ontario test site data; however, precipitation was allocated in three different ways in the 6-h window. The three ways that precipitation was allocated were a rectangular distribution, a standard normal distribution $N(0,1)$, and all in 1 h. Graphical representations of the three distributions are presented in Figure 1 based on 5 mm of precipitation over a 6-h period.

The results for IRI, longitudinal cracking, alligator cracking, transverse cracking, AC rutting, and total pavement rutting were the same for all three distributions. A rectangular distribution was selected for use in the HCD files. The HCD format is

```
[Year][Month][Day][Hour],[Temp.],[Wind Speed],[% Sunlight],[Precip.],[Rel.Humidity]
1990010100,33.98,8.08,40,0,61
1990010101,28.94,3.73,50,0,75
1990010102,30.38,3.73,30,0,79
...
2005103123,33.08,6.84,0,0,92
```

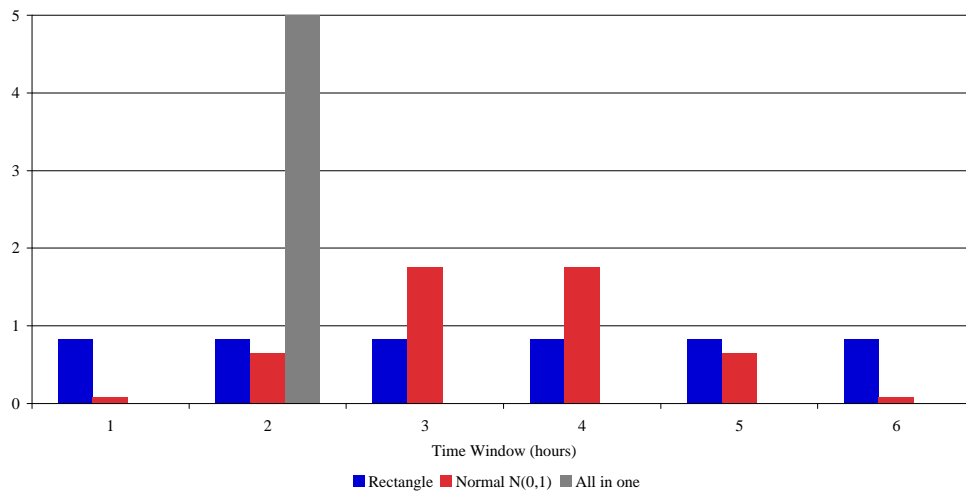

FIGURE 1 Climatic distributions.

Reading the HCD (taken from Alberta control), on January 1, 1990, the temperature at 12 p.m. was 33.98°F, wind was 8.08 mph, four-tenths cloud opacity, 0 in. of precipitation and a relative humidity of 60%.

METHODOLOGY

1. A 20-year control simulation was performed for each test site using the actual weather information from the last 15 years. The M-E PDG automatically repeats 5 years of data to total 15 years.

2. A full 4 by 5 factorial analysis was performed for each test site. Precipitation was varied by 0% (control), -5%, +5%, +10%, and +25%. The four temperature variations investigated were +0°C (control), +1°C, +2°C, and +5°C.

3. By using the M-E PDG default MR&R trigger values for the pavement performance indicators, the impact of temperature increase was assessed. The change in time to reach the trigger value was calculated by dividing the difference between the control and the test value with the temperature change. This gave a value in years per degree Celsius.

4. The resulting pavement performance indicators of each run were compared to the control results. Regression analysis was performed and two-factor analysis of variance (ANOVA) was used to determine if there was any significant difference in the simulations. The alpha level was set at 0.05 to provide a 95% confidence interval.

PAVEMENT PERFORMANCE

Pavement performance was simulated for Alberta and Ontario for a period of 20 years. Pavement performance was assessed through looking at surface roughness as described by the IRI,

longitudinal cracking, alligator cracking, transverse cracking, AC deformation, and total deformation in response to changes in temperature and precipitation.

International Roughness Index

Figures 2 and 3 illustrate the M-E PDG IRI results for Alberta and Ontario at the end of the 20-year simulation period. In general, the IRI increases as temperature and precipitation increase. As IRI increases, the other pavement performance indicators also increase.

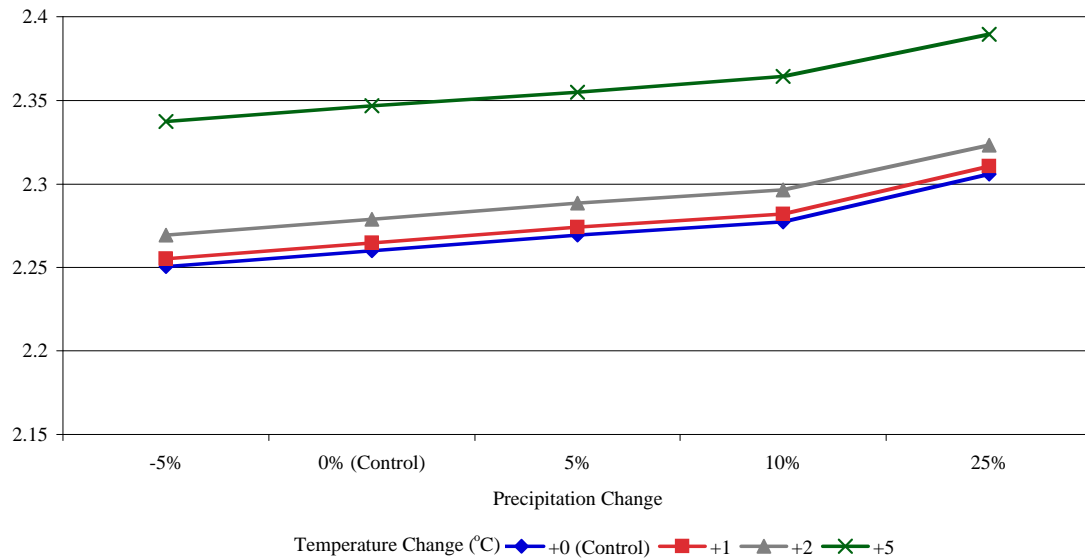

FIGURE 2 Alberta IRI performance.

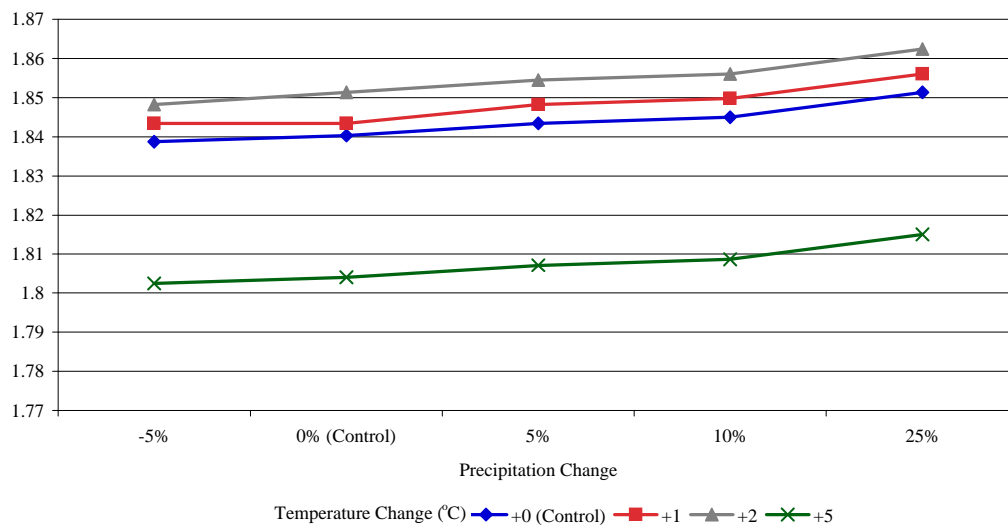

FIGURE 3 Ontario IRI performance.

Longitudinal Cracking

Figures 4 and 5 show the longitudinal cracking results from the 20-year M-E PDG simulations in Alberta and Ontario. Longitudinal cracking increased with more precipitation. For Alberta an increase in temperature decreased longitudinal cracking, but for Ontario, longitudinal cracking increased as temperature increased. Longitudinal cracking is usually due to asphalt fatigue and will progress to alligator cracking over time. The fatigue can be attributed to loading, hardening of the asphalt binder, and pavement surface temperatures

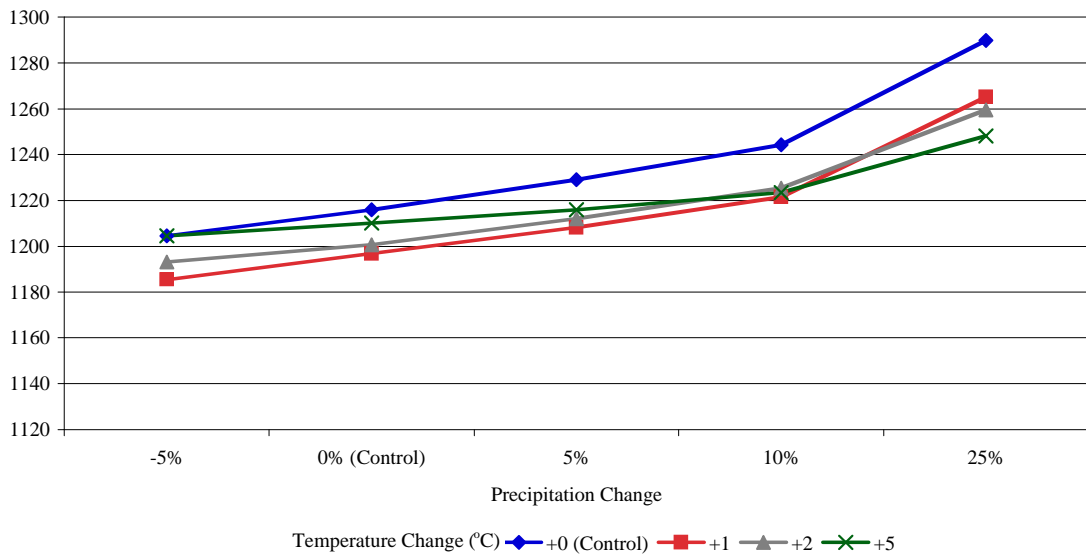

FIGURE 4 Alberta longitudinal cracking performance.

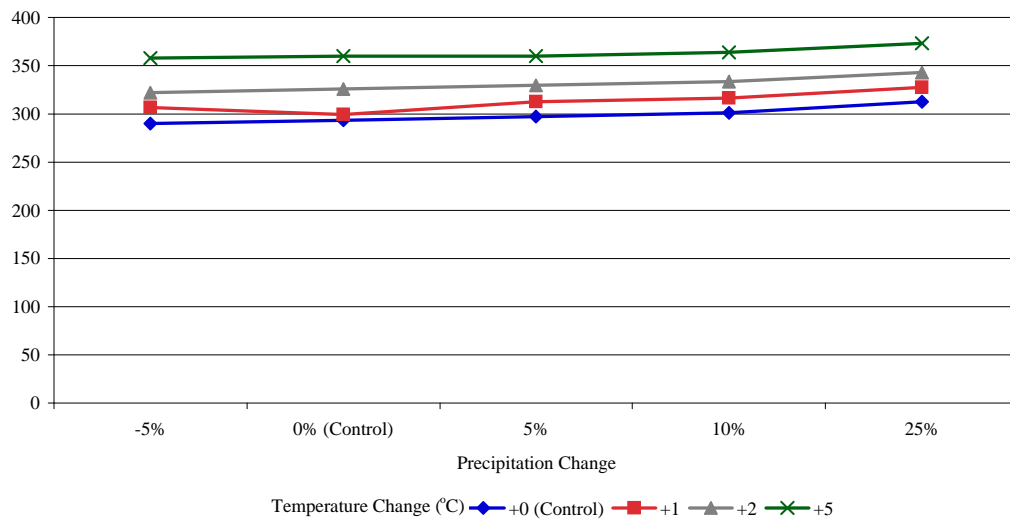

FIGURE 5 Ontario longitudinal cracking performance.

Alligator Cracking

Figures 6 and 7 present the alligator cracking results for Alberta and Ontario at the end of the 20-year M-E PDG simulation. In general, alligator cracking increases as temperature and precipitation increase. Alligator cracking will often begin as longitudinal cracking; once the cracking begins, repeated loading will further deteriorate the pavement structure.

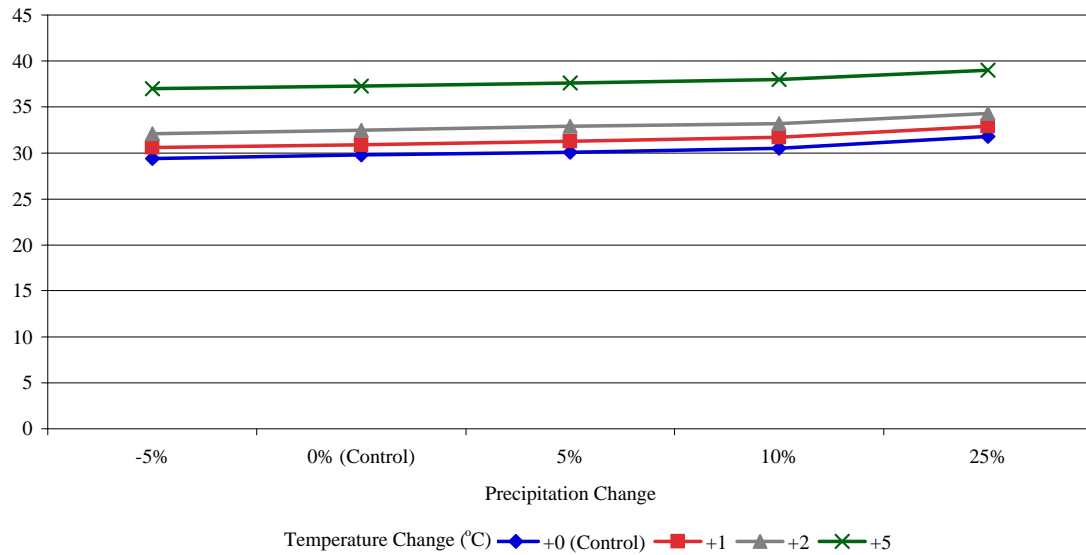

FIGURE 6 Alberta alligator cracking.

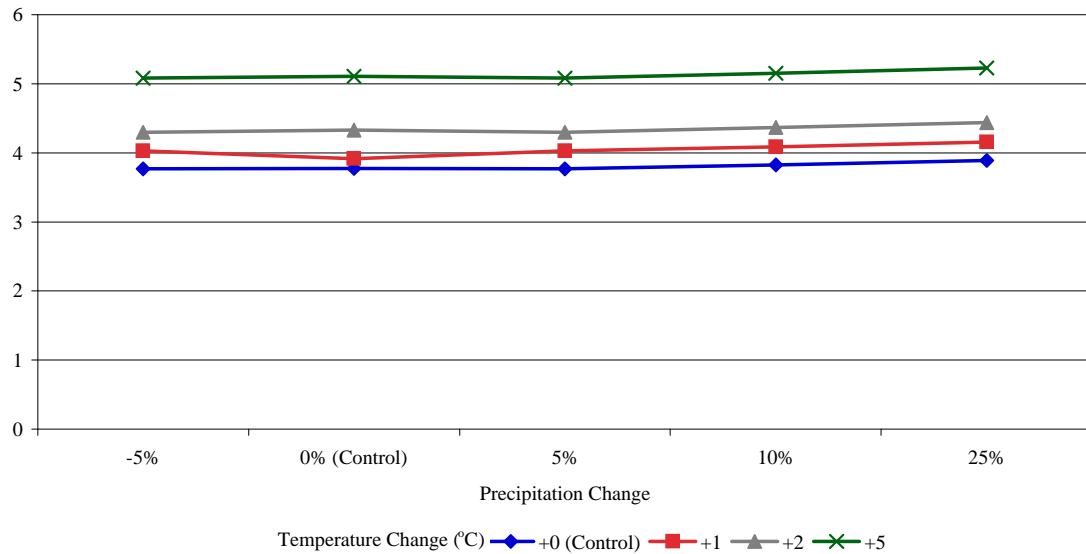

FIGURE 7 Ontario alligator cracking.

Transverse Cracking

Figures 8 and 9 illustrate the transverse cracking results of the M-E PDG simulation for Alberta and Ontario at the end of the 20-year simulation period. Transverse cracking is not greatly affected by changes in temperature and precipitation, except as seen in Ontario where cracking decreased when the temperature increased by +5°C. Transverse cracking or thermal cracking is caused by the hardening of the asphalt binder leading to shrinkage at low temperatures.

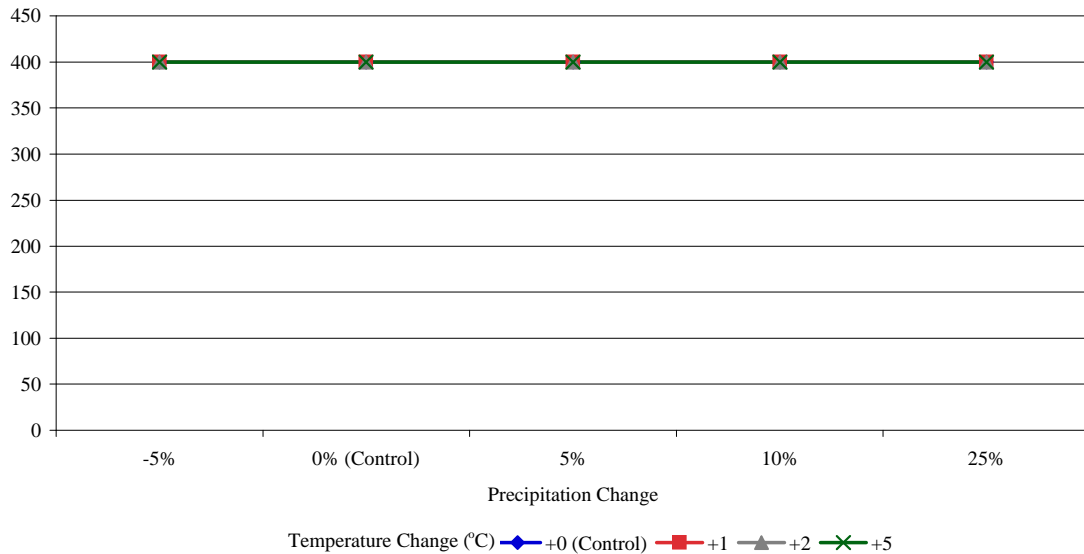

FIGURE 8 Alberta transverse cracking.

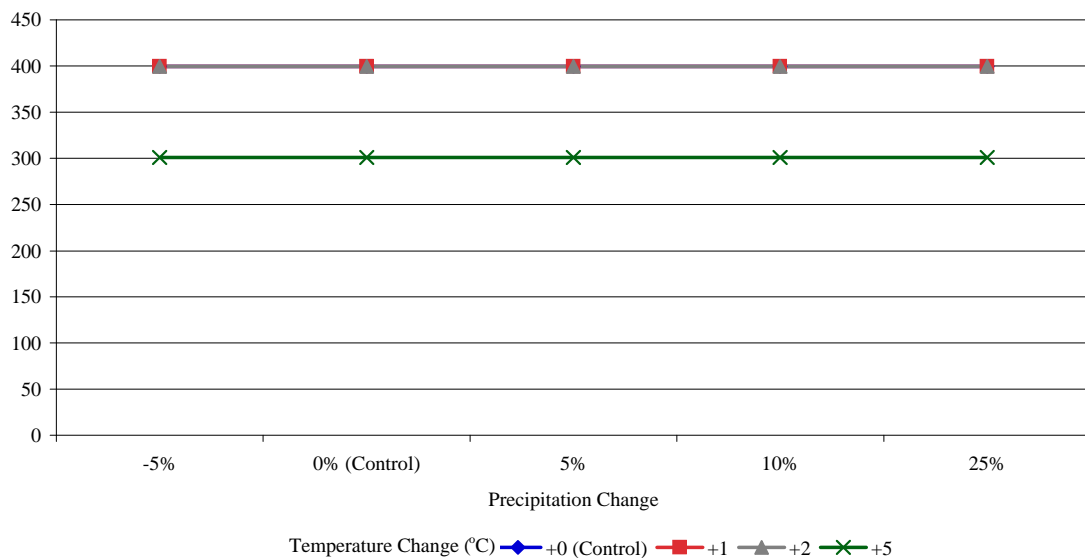

FIGURE 9 Ontario transverse cracking.

AC Deformation

Figures 10 and 11 show the results from the 20-year M-E PDG simulation for AC deformation in Alberta and Ontario. AC deformation increases with temperature and remains constant with increases in precipitation. The primary causes of AC deformation or rutting are moisture infiltrating the pavement and weakening the pavement structure and repeated loading of the pavement.

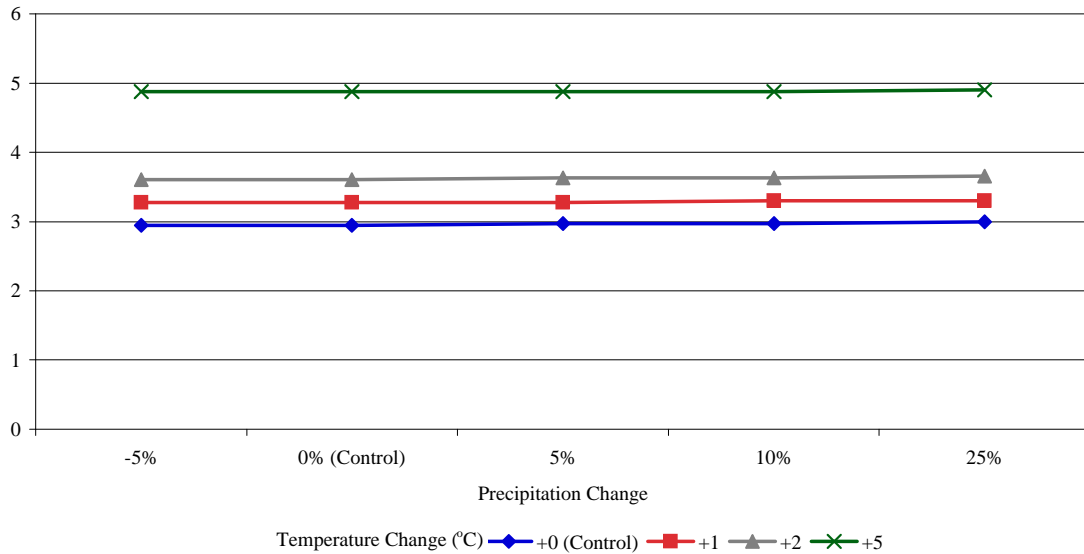

FIGURE 10 Alberta AC deformation.

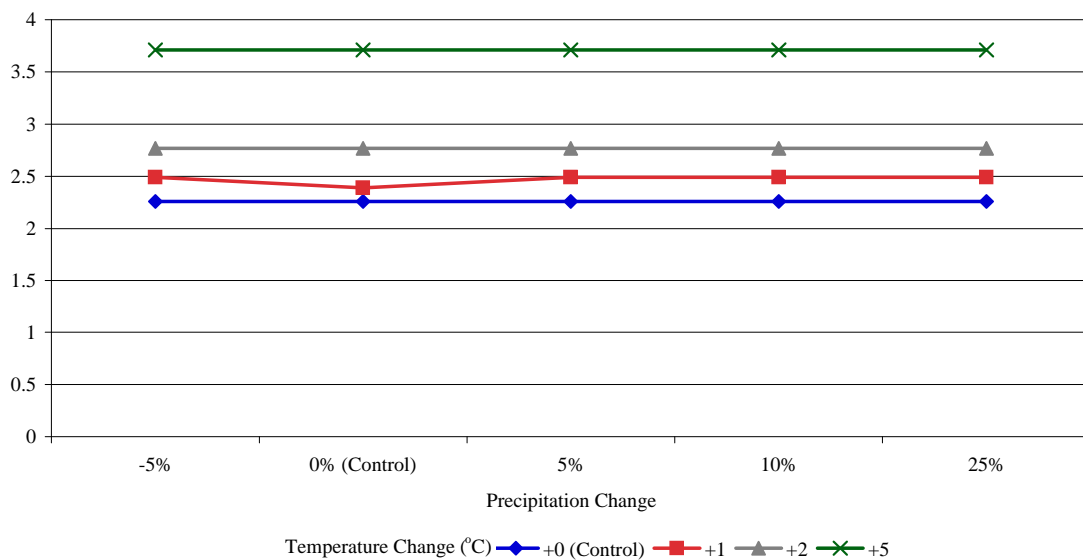

FIGURE 11 Ontario AC deformation.

Total Deformation

Figures 12 and 13 present the performance results for Alberta and Ontario at the end of the 20-year M-E PDG simulation. In general, the total deformation cracking increases as temperature and precipitation increase. The Ontario test section performed better than the Alberta test section.

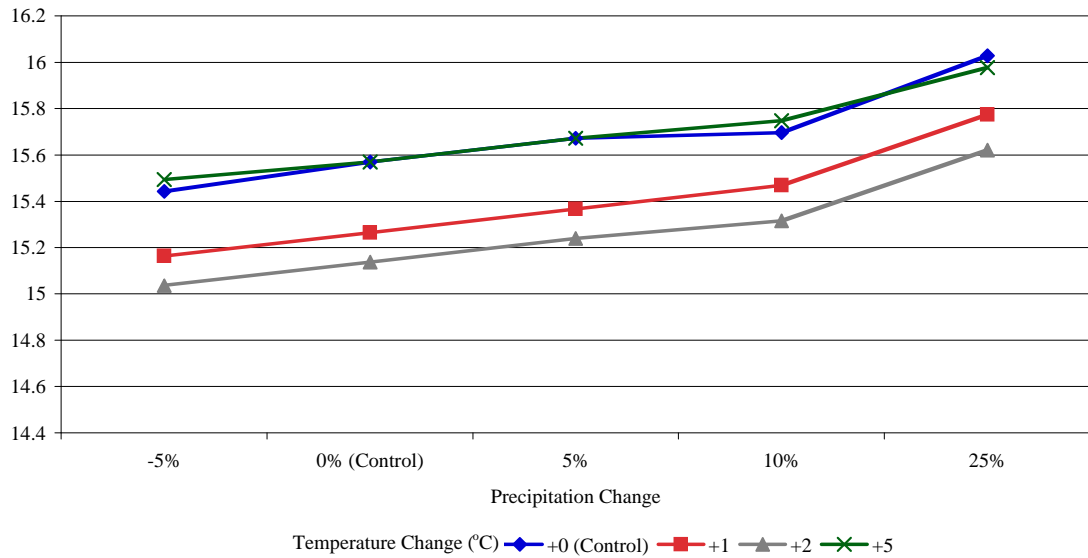

FIGURE 12 Alberta total deformation.

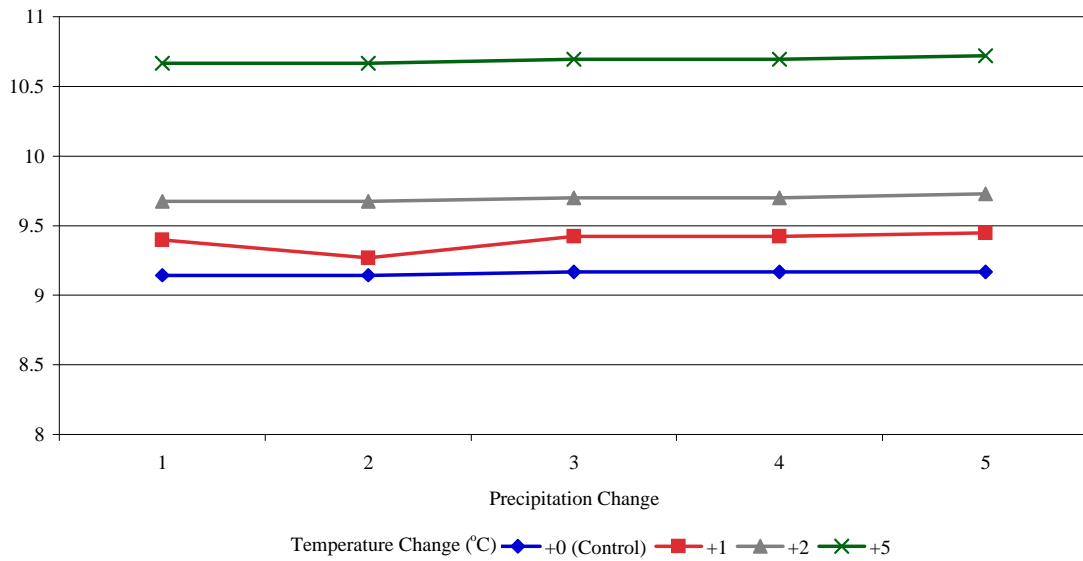

FIGURE 13 Ontario total deformation.

Impact of Climate Changes on Pavement Performance

Table 2 shows how a temperature increase shortens the time to reach the MR&R trigger level. Based on the M-E PDG simulations, MR&R activities would be minimally affected with a 1°C increase in temperature. Transportation agencies would likely not change MR&R activities until a 2°C or higher increase in temperature.

Results Summary

Both the Alberta and Ontario performance results as a function of temperature and precipitation are consistent with what would be expected. As temperature increases, accelerated pavement deterioration due to traffic loads on a warmer pavement is expected and was observed. An increase in temperature would facilitate rutting because the pavement is softer. Pavement movement due to loads on a softer pavement would also result in increased cracking. An increasing precipitation would provide opportunity for more moisture in the pavement, leading to accelerated deterioration. Given the levels of pavement deterioration occurring in the simulations, it would be expected that the pavement would also have a significant amount of transverse cracking. Both test sites had a soft AC binder. The authors believe that the M-E PDG model is biased toward stiffer binder materials, resulting in more transverse cracking for stiffer binders.

STATISTICAL ANALYSIS

A two-factor ANOVA was performed to determine if the pavement performance results were significantly different based on temperature and precipitation changes. The results are shown in Table 3.

For both the Alberta and Ontario simulations, temperature and precipitation changes significantly affected the level of pavement distress for IRI, longitudinal cracking, alligator cracking, AC deformation, and total deformation. However, for Alberta and Ontario transverse cracking did not significantly change. Also, the AC deformation was not statistically significant in Ontario. The residual mean squared error is small compared to the temperature mean squared error in all scenarios. This shows that the temperature and precipitation effects account for the majority of the variation in the data alone, indicating there is no significant interaction.

TABLE 2 Impact of Temperature Increase on MR&R

	Trigger Level	Alberta		Ontario	
		Time to Trigger	$\Delta + 1^\circ\text{C}$	Time to Trigger	$\Delta + 1^\circ\text{C}$
IRI	2.72 m/km	Not reached	0.01 m/km	Not reached	0 m/km
Longitudinal cracking	189.4 m/km	5 years	-8.21 m/km	13.5 years	15.59 m/km
Alligator cracking	25%	18 years	1.36%	Not reached	0.26%
Transverse cracking	189.4 m/km	1 year	0 m/km	3.5 years	-6.56 m/km
AC deformation (rutting)	6.4 mm	Not reached	0.35 mm	Not reached	0.26 mm
Total deformation (rutting)	19.1 mm	Not reached	-0.16 mm	Not reached	0.28 m/km

TABLE 3 ANOVA, Significance of Changes in Precipitation and Temperature

	IRI	Cracking			Deformation	
		Longitudinal	Alligator	Transverse	AC	Total
Temperature						
<i>F</i> calculated	1,6615.52	8.83	9,628.99	—	4,6727.43	351.91
<i>F</i> critical (3,12,0.05)	3.49	3.49	3.49	3.49	3.49	3.49
Significant	Yes	Yes	Yes	No	Yes	Yes
Precipitation						
<i>F</i> calculated	3,568.30	55.31	525.54	—	13.29	298.04
<i>F</i> critical (4,12,0.05)	3.26	3.26	3.26	3.26	3.26	3.26
Significant	Yes	Yes	Yes	No	Yes	Yes
Temperature						
<i>F</i> calculated	8,279.846	471.551	1,881.492	4.46E+13	3,961.417	2,626.186
<i>F</i> critical (3,12,0.05)	3.49	3.49	3.49	3.49	3.49	3.49
Significant	Yes	Yes	Yes	Yes	Yes	Yes
Precipitation						
<i>F</i> calculated	383.77	32.65	17.42	—	1.00	4.01
<i>F</i> critical (4,12,0.05)	3.26	3.26	3.26	3.26	3.26	3.26
Significant	Yes	Yes	Yes	No	No	Yes

DETAILED CLIMATIC CHANGE SCENARIOS

The results of the 4 by 5 factorial design showed that the M-E PDG was able to distinguish changes in temperature and precipitation and relate this to measurable changes in performance. Changing the temperature and precipitation by fixed amounts for all time periods is representative of anticipated climate change. Two atmospheric and ocean general circulation models (AOGCMs) were used to develop detailed hourly climatic data files for Ontario and used in the M-E PDG. The first model is derived from the Canadian Center for Climate Modeling and Analysis Coupled Global Climate Model 2 A2x emission experiment (CGCM2A2x), and the second model is from the Hadley Climate Model 3 B21 experiment (HadCM3B21). The performance of these models have been internationally recognized.

CGCM2A2x and HadCM3B21 Climate Summary

To illustrate the detailed climate change scenarios, four key indicators (number of freeze–thaw cycles, freezing index, mean annual air temperature, and mean annual rainfall) used in the M-E PDG were calculated and compared to some of the results from the factorial experiment. The results are presented in [Table 4](#).

The four indicators show that the CGCM2A2x and HadCM3B21 climate change scenarios fall within the minimum (+1°C, –5% precipitation) and maximum (+5°C, +25% precipitation) limits of the factorial experiment.

CGCM2A2x and HadCM3B21 Pavement Performance

The simulation performance results for the detailed climate change scenarios are presented in [Table 5](#).

TABLE 4 Simulation Climate Summaries

	Freeze–Thaw Cycle	Freezing Index (°F day)	Temperature^a (°C)	Rainfall^a (mm)
Control	68	941.7	46.97	31.54
+1°C, –5% precipitation	63	796.06	48.77	29.96
+5°C, +25% precipitation	45	383.27	55.97	39.43
CGCM2A2x	56	471.55	52.82	31.17
HadCM3B21	57	668.57	51.4	32.45

^a Mean annual values.

TABLE 5 Detailed Climatic Scenario Performance Results

	IRI (m/km)	Cracking			Deformation	
		Long. (m/km)	Alligator (%)	Trans. (m/km)	AC (mm)	Total (mm)
Control	1.84	293.56	3.78	399.62	2.26	9.14
+1°C, –5% precipitation	1.84	306.82	4.03	399.62	2.49	9.40
+5°C, +25% precipitation	1.82	373.11	5.23	301.14	3.71	10.72
CGCM2A2x	1.91	416.67	7.60	299.24	6.45	13.79
HadCM3B21	1.99	428.03	7.77	399.62	6.55	14.00

Three trends can be identified based on the M-E PDG pavement performance results: (1) the CGCM2A2x model produces slightly more conservative results than the HadCM3B21 model; (2) compared to the factorial control climate scenario all the performance measures increase significantly except for the amount of transverse cracking that decreases or remains constant; and (3) at the end of the 20-year simulation both detailed climate change scenarios have exceeded the trigger levels for longitudinal cracking, transverse cracking, and AC deformation.

CONCLUSIONS

The purpose of this study was to examine how pavement performance would be impacted over the next 20 years with changes associated with global warming, namely changes in temperature and precipitation. The results presented here are for two case studies, one from Alberta and one from Ontario. Temperature and precipitation increases were shown to have a negative impact on the pavement performance in the Canadian environment. In most situations a 1°C temperature increase will not significantly affect the pavement MR&R activity; however a larger temperature increase would show noticeable differences. The detailed climatic models showed that climate change will significantly accelerate pavement deterioration greater than the maximum factorial climate change scenario.

This study also found that the M-E PDG may have a limited application due to several factors:

1. The M-E PDG results were not sensitive enough to distinguish between precipitation amounts.
2. For soft AC binders the M-E PDG was not sensitive enough to reflect changes in transverse cracking.

In closing, the following scenarios will be examined in future studies.

1. Expand HCD files to contain more years and new sites. This will allow the number of years of climatic data to match the pavement design and analysis.
2. Perform sensitivity analysis for the remaining provinces and territories using both the 4 by 5 factorial and detailed climatic change models.
3. Perform a sensitivity analysis for portland cement concrete pavements.

ACKNOWLEDGMENTS

The authors gratefully acknowledge the funding of the Climate Change Action Fund under Project A812 and the partnership with Environment Canada and the Adaptation and Impacts Research Group, Meteorological Services of Canada

REFERENCES

1. Hudson, W. R., R. Haas, and W. Uddin. *Infrastructure Management: Integrating Design, Construction, Maintenance, Rehabilitation, and Reconstruction*. McGraw-Hill, New York, 1997.
2. Environment Canada. *National Annual Temperature Scenario 2005*. Natural Resources Canada, Ottawa, 2006. <http://atlas.nrcan.gc.ca/site/english/maps/climatechange/scenarios>.
3. Applied Research Associates, Inc., ERES Consultants Division. *Guide for Mechanistic-Empirical Design of New and Rehabilitated Pavement Structures*. NCRHP Project 1-37A, National Cooperative Highway Research Program, Washington, D.C., 2004.
4. Dore, G., S. Tighe, and D. Hein. *Roadmap for the Calibration and Implementation of the Mechanistic-Empirical Design of New and Rehabilitated Pavement Structures*. Transportation Association of Canada, Ottawa, Ont., 2005.
5. Hall, K. D., and S. Beam. *Estimation of Sensitivity of Design Variables for Rigid Analysis Using Mechanistic-Empirical Design Guide*. Presented at 84th Annual Meeting of the Transportation Research Board, Washington, D.C., 2005.
6. Flato, G. M., G. J. Boer, W. G. Lee, N. A. McFarlane, D. Ramsden, M. C. Reader, and A. J. Weaver. The Canadian Centre for Climate Modelling and Analysis Global Coupled Model and its Climate. *Climate Dynamics*, Vol. 16, No. 6, 2000, pp. 451–467.
7. Gordon, C., C. Cooper, C. A. Senior, H. Banks, J. M. Gregory, T. C. Johns, J. F. B. Mitchell, and R. A. Wood. The Simulation of SST, Sea Ice Extents and Ocean Heat Transports in a Version of the Hadley Centre Coupled Model Without Flux Adjustments. *Climate Dynamics*, Vol. 16, 2000, pp. 147–168.
8. *Coupled Model Intercomparison Project*. www-pcmdi.llnl.gov/cmip. Accessed June 2001.
9. Mills, B., S. L. Tighe, J. Andrey, J. T. Smith, S. Parm, and K. Huen. *The road well-traveled: Implications of climate change for pavement infrastructure in southern Canada*. Final report prepared for the Climate Change Impacts and Adaptation Program, Natural Resources Canada. Adaptation and Impacts Research Division, Environment Canada, and University of Waterloo, Waterloo, Canada.

WEATHER AND PAVEMENTS

SafeLane Overlay Performance Testing

Winter 2005–2006

WILFRID A. NIXON
University of Iowa

During the winter of 2005–2006 a new pavement overlay was tested for performance under winter conditions. The overlay uses an epoxy or polymer base, with a specially selected dolomitic limestone aggregate. The combination of the two creates a surface that is capable of retaining ice-control chemicals at the surface for much longer than regular pavements or overlays. The purpose of the testing during the 2005–2006 winter was to determine how well this new overlay (the SafeLane overlay system) performed and to measure the potential benefits of using such an overlay. In total, nine sites were considered in the performance tests, located in Texas, Wisconsin, Indiana, Ohio, Virginia, and New York. At one of these sites (the Wolf River Bridge in Crandon, Wisconsin) the overlay was installed during 2003. All the other sites were installed during 2005. Of the nine sites, seven were bridges, one was an exit ramp from a turnpike, and one was an on ramp to a bridge. Five of the bridges were on divided highways and only one carriageway of the bridge received the overlay, thus allowing a direct comparison with the control site on the other carriageway. The performance of the overlays was examined with three particular issues in mind. First, did the overlay create any problems when liquid chemicals were applied? Second, did the overlay delay the adhering of snow and ice during winter storms, and if so, was this delay achieved with more, the same, or less chemicals than the control section of the highway? And third, did the overlay provide any measurable improvement in safety for the traveling public? This paper will present the detailed results of the performance testing. In summary, there were no problems experienced with application of liquids to the overlay, the overlays consistently stayed free of snow and ice longer than comparable control sections, and could be kept clear with fewer chemicals than control sections, and finally significant safety benefits (in the form of reduced numbers of crashes) were observed for the overlays. Additional performance testing of the overlay system is planned for the 2006–2007 winter, with many additional sites being included in this second phase of testing.

Prior to the 2005–2006 winter season, a pavement overlay product, Safelane was installed at eight locations around the United States. In 2003, the overlay had been installed at one single location for lengthier testing. [Table 1](#) lists these nine sites.

The overlay, which is based on technology described in U.S. Patent Number 6,849,198 (anti-icing coating and methods), uses a special aggregate that acts, together with an adhesive, in a sponge-like manner such that when an anti-icing liquid is applied to the surface, it is retained for a significant portion of time (typically, many days) and remains effective as an anti-icing chemical during that time.

From a winter maintenance perspective, the purpose of the testing during the 2005–2006 winter was twofold. The first goal was to determine the extent to which the overlay would extend anti-icing chemical effectiveness. In some of the installations, this goal was further refined to indicate a desire for reduction of accidents, a normal beneficial outcome of successful anti-icing activities. A second goal was to determine whether there were any unforeseen problems arising

with the use of the product. The different locations allowed the product to be evaluated under a number of different conditions, including not only bridges, but also on and off ramps.

SITE DESCRIPTIONS

McLean Bridge, McLean, Texas

This site is located on Interstate 40 on the westbound bridge at mile marker 144. The location is about 70 mi East of Amarillo, Texas, and is in a rural location. The bridge is prone to icing during winter weather, and the area of the bridge that was treated amounted to about 12,000 ft². A primary concern for the operators of the structure was to reduce accidents. The bridge experiences several accidents each winter.

I-80 Eastbound, Brecksville Ohio

This site is located on I-80 (the turnpike segment) on the eastbound side, at exit 173. The exit ramp, an incline with a tight curve, has been treated with the overlay. A total area of about

TABLE 1 Site Locations

Site	Location	Type	Date of Installation
McLean Bridge, Texas	I-40, mile marker 144, 70 mi east of Amarillo	Two-lane elevated bridge, westbound side only, 12,000 ft ²	November 2005
Brecksville, Ohio	I-80, exit 173 on Ohio Turnpike	Exit ramp, incline with curve, 8,000 ft ²	November 2005
Harrisonburg, Virginia	I-81, northbound, milepost 239.71	Two-lane elevated bridge, northbound side only, 13,203 ft ²	September 2005
Staunton, Virginia	I-81, southbound, milepost 219.78	Two-lane elevated bridge, southbound side only, 7,164 ft ²	September 2005
Ironwood Bridge, Indiana	Ironwood Overpass, South Bend, Indiana	Eastbound lane of the overpass, 11,790 ft ²	May 2005
Blatnick Bridge On-ramp, Wisconsin	Blatnick Bridge on Rt. 53 between Superior and Duluth	On-ramp for the bridge, 15,000 ft ²	June 2005
Buffalo Creek Bridge, New York	Two Rod Road over Buffalo Creek, near Buffalo, New York	Both lanes of a two-lane bridge deck, 8,400 ft ²	September 2005
Davis Bridge, New York	I-86 westbound over Rt. 430 East	Two-lane elevated bridge, westbound only, 16,400 ft ²	October 2005
Wolf River Bridge, Wisconsin	Rural bridge over the Wolf River, near Crandon Wisconsin	Two-lane bridge, covered on both directions, 4,800 ft ²	Summer 2003

8,000 ft² was treated. The setting is rural, and a major concern for the location is to reduce accidents. Over the prior 2 years, 49 accidents had occurred.

Harrisonburg, Virginia

This overlay is placed on the northbound leg of structure 2024 on I-81, at milepost 239.71. The setting is rural. The area treated was 13,203 ft². Average daily traffic is approximately 24,000 vehicles (one way), with 26% of those being trucks. A primary concern for this structure is surface renewal and deck protection.

Staunton, Virginia

This overlay is placed on the southbound leg of structure 2037 on I-81, at milepost 219.78 (about 20 mi from the Harrisonburg Bridge above). The area treated on this bridge is 7,164 ft². Average daily traffic is approximately 22,000 vehicles (one way), with 32% of those being trucks. As for the Harrisonburg Bridge above, a primary concern for this structure is surface renewal and deck protection.

Ironwood Bridge, South Bend, Indiana

This bridge is located on the Ironwood Bridge overpass (on the US-20 bypass), near South Bend Indiana, specifically on the eastbound lane of the overpass. The setting is urban. The area of bridge deck that was treated was 11,790 ft². Average daily traffic is 30,000 vehicles. A primary concern for this installation was the reduction of accidents.

Blatnick Bridge On Ramp, Superior, Wisconsin

This structure is the on ramp for Route 53. It is in an urban setting, onto the bridge linking the cities of Superior, Wisconsin, and Duluth, Minnesota. The area of deck treated was 18,000 ft². Average daily traffic is 15,000 vehicles. The primary concern for this on ramp was to reduce accidents, of which there have been 20 over the past 4 years.

Buffalo Creek Bridge, New York

This is a rural bridge on Two Rod Road, near Buffalo. The deck was treated in both directions, with a total treated area of 8,400 ft². Average daily traffic was 2,145. The primary concern at this location was extending bridge life.

Davis Bridge, New York

This bridge is on I-86, on the westbound lanes. The bridge passes over Route 430 East, fairly close to the state line with Pennsylvania. The setting is rural. The area of bridge treated was two lanes wide, with total area of 16,400 ft². Average daily traffic is 10,845.

Wolf River Bridge, Crandon, Wisconsin

This is a rural bridge about 120 ft long. The whole deck (both lanes) was treated in the summer of 2003. Average daily traffic is in the range of 5,000 to 8,000. One concern about this bridge was that prior to treatment there had been three to four wintertime accidents each year.

OBSERVATIONS OF SITE PERFORMANCE

McLean Bridge, McLean, Texas

The standard treatment for the structure was to apply magnesium chloride brine at a rate of 30 gal per lane mile. In terms of results, the primary information for this site comes from a 3-day ice storm in the middle of December. During the storm, temperatures (presumably air temperatures, although this was not specified) ranged between 26°F and 28°F. The structure (the westbound side of a bridge on I-40) was treated once prior to the storm start, with 30 gal per lane mile of magnesium chloride, a standard application. The test site received no further treatment throughout the whole storm. The test site never iced over, and no accidents occurred at that location.

In contrast, other locations experienced significant problems with ice accumulations, and there were numerous accidents “up and down the interstate.” Further, one accident occurred on the eastbound bridge adjacent to the test section. The clear implication is that in this circumstance, the SafeLane overlay was extremely effective both in preventing the accumulation of ice on the highway and in preserving the safety and mobility of the highway for the traveling public.

I-80 Eastbound, Brecksville, Ohio

No formal records of chemical applications and overlay performance were available for this test sections. Discussions with the chief maintenance engineer, Tim Ujvari, indicated three primary results from the winter of testing. First, no problems were encountered with the overlay during the winter season. Second, fewer slide-offs (vehicles leaving the exit ramp in an uncontrolled skid) occurred this winter, with the caveat that some (but not all) of the reduction may be due to a somewhat milder winter than normal. Third, Ujvari indicated that the lifetime performance of the overlay will be an important consideration, and of course, one winter does not provide information on the expected lifetime of the overlay.

The two key factors here are that a reduction in accidents was observed, and that no problems with the overlay were encountered.

Harrisonburg, Virginia, and Staunton, Virginia

For these test sections, detailed information was provided on the initial application of liquid to both the test sections and the control section. A spray truck applied salt brine at a rate of 30 gal per lane mile, and made two passes per lane. Each pass was 9 to 10 ft wide, and there was thus a 4- to 5-ft overlap in the center of each lane. Further, a 2-ft overlap occurred at the centerline.

There was no spray or mist caused by traffic during the application process. Within 5 min of application, the surface in the wheel track area was dry. Between the wheel tracks dried out in about 20 min. The weather was clear and sunny. Surface temperatures were between 51°F and 39°F at time of application, which is somewhat significant. There is concern that if ice-control liquids are applied at relatively high surface temperatures (above 40°F seems to be the accepted limit) there is a possibility that as the liquids penetrate the road surface and dry out, they may pass through a state in which they can be very slippery or slick. It is clear from the observations in Virginia that this did not happen.

The winter in Virginia was very mild in 2005–2006, thus relatively few events (snow storms or frosts) occurred in which the performance of the overlay could be compared with the control section. Indeed, when significant winter events did occur (e.g., December 8 and December 15, 2005), maintenance personnel plowed and applied chemicals equally to both the test and the control sections. No difference in performance between the test and controls was observed. However, this is to be expected, given that the benefit of the SafeLane overlay lies in the persistence of the ice control chemical within the overlay, and winter conditions for the Virginia test sites were such that the benefits of this ability were not tested.

Ironwood Bridge, South Bend, Indiana

Data for the Ironwood Bridge comprise both data sheets and anecdotal reports. The bridge has been treated with a salt (sodium chloride) brine during the winter. The first anecdotal report is dated December 1, 2005, and notes (explanatory comments added in parentheses):

The bridge westbound (control section) was slushy and a little slippery. The new bridge eastbound (test section) was just wet. Nothing stuck. We anti-iced Tuesday (two days prior to event). The bridge worked this time.

The next anecdotal report stems from a meeting on December 13, 2005. At this meeting, it was noted they had three documented cases where the test section performed better in a winter event than the surrounding roads and structures. This included one instance where the temperature dropped to 8°F (it is not clear if this is a surface or an air temperature, but it is likely an air temperature) and everything except the test section froze, while the test section remained wet. The one comment from this meeting that was not totally positive was that the bridge was a little rough to drive over.

A further anecdotal report is dated December 14, 2005. This notes

A little bit of snow just fell and stated to turn things a little snotty. We shot the westbound side (control section) and by the time we were going to shoot the eastbound side (test section) it was already melting off.

The note further explains that only a matter of a few minutes separated the truck from the westbound and eastbound sites.

Tabulated data are available for this test site for December 13 and 14, January 23 and 24, February 9 and 12, and February 17. [Table 2](#) presents the information from these events.

TABLE 2 Field Data for the Ironwood Bridge

Date and Time	Road and Weather Conditions	Applications	Condition of Test and Control Sites
12/13/05 @ 12 p.m.	No snow and pavement temperature (PT) = 32°F	35 gal a lane mile of salt brine applied in anti-icing mode	Pretreatment, so no precipitation at this point.
12/14/05 @ 9:40 a.m.	Light snow, PT = 26°F	200 lbs per lane mile of salt	Test section clear, control section slushy.
Same @ 12:40 p.m.	Freezing rain, PT = 29°F	200 lbs per lane mile on control section only	Control section had ice, test section was wet.
Same @ 1:40 p.m.	Freezing rain and snow, PT = 30°F	250 lbs per lane mile on control, 230 on test	No report.
Same @ 3:15 p.m.	Freezing rain, PT = 31°F	200 lbs per lane mile on both	Control section had ice, test section was wet.
Same @ 4:05 p.m.	Freezing rain, PT = 29°F	200 lbs on control section only	No report on control section, test section still wet.
Same @ 5:25 p.m.	Freezing rain, PT = 29°F	250 lbs per lane mile on control section, 230 on test	Control section had only wheeltracks bare, test section still wet.
1/23/06 @ 9:00 a.m.	No snow, PT = 30°F	Anti-icing at 40 gal per lane mile	Snow and frost were in the forecast.
1/24/06 @ 9:00 a.m.	Light snow, PT = 30°F	200 lbs per lane mile of salt on control section	Control section was snow covered prior to treatment, test section did not need treatment.
2/9/06 @ 9:00 a.m.	No snow, PT = 21°F	Anti-icing at 40 gal per lane mile	No report.
2/12/06 @ 9:20 a.m.	Light snow, PT = 28°F	200 lbs per lane mile to control section	Control section was snow covered prior to treatment, test section did not need treatment.
Same @ 10:30 a.m.	Light snow, PT not recorded	200 lbs per lane mile to control section, 100 lbs to test section	Control section had snow present prior to spreading, test section was still wet.
Same @ 12:00 p.m.	Light snow, PT = 32°F	200 lbs per lane mile to control section, 100 lbs to test section	Control section had snow present prior to spreading, test section was still wet
2/17/06 @ 2:00 a.m.	Light snow, PT not recorded	220 lbs per lane mile to both sections	Both sections had snow prior to treatment—rain in previous days may have removed chemical residual.
Same @ 4:00 a.m.	Light snow, PT = 27°F	200 lbs per lane mile to control section, none to test section	Test section was still clear from prior treatment, control section had icy film prior to this application.

Blatnick Bridge On Ramp, Superior, Wisconsin

The primary concern for this structure was to address the issue of accidents. During the four years prior to installation of the overlay, about 20 accidents had occurred. During this past winter, no accidents occurred. A summary comment, provided by Jeffrey Hall of Minnesota Department of Transportation (DOT), is, “The area where the SafeLane was applied holds the chemical longer and when it does become snow covered it seems to still have more traction than the surrounding area.”

Data sheets for treatment of the structure are available for January and February 2006. The information on these sheets is presented in summary form in Table 3 below. In general terms, typical chemical applications for this area would be in the range of 300 to 400 lb per lane mile of solid chemicals (and granular salt), and 20 gal per lane mile of magnesium chloride brine (in anti-icing mode). The structure was “charged” about every 2 weeks with an application of about 15 gal per lane mile of magnesium chloride brine.

TABLE 3 Field Data for the Blatnick Bridge

Date and Time	Road and Weather Conditions	Applications	Condition of Test and Control Sites
1/6/06 @ 4:00 a.m.	No precipitation, PT = 31°F	21 gal per lane mile, liquid, anti-icing	Both were clear and dry.
1/11/06 @ 4:00 a.m.	No precipitation, PT = 27°F	18 gal per lane mile, liquid, anti-icing	Clear and dry.
1/19/06 @ 4:00 a.m.	No precipitation, PT = 24°F	25 gal per lane mile, liquid, anti-icing	No report.
1/22/06 @ 11:00 a.m.	Freezing rain and sleet, PT = 29°F	Solid chemicals applied twice, at 200 lbs per lane mile each time	Test site was clear and wet, and was not slippery.
1/26/06 @ 4:00 a.m.	No precipitation, PT = 17°F	27 gal per lane mile, liquid, anti-icing	Clear and dry.
1/30/06 @ 4:00 a.m.	No precipitation, PT = 21°F	23 gal per lane mile, liquid, anti-icing	Clear and dry.
2/9/06 @ 8:00 a.m.	Wet, heavy snow, about 2 to 4 in., PT = 18°F	3 applications of solid chemicals at 200 lbs per lane mile each time	Slush present on test site, but it remained clear longer than control site.
2/10/06 @ 7:30 a.m.	Snow, air temperature = 22°F	2 applications of solid chemicals at 400 lbs per lane mile each time	Slush present on both test and control site. No differences between the two were noted.
2/20/06 @ 7:00 p.m.	Normal snow, PT = 17°F	1 application of solid chemicals at 200 lbs per lane mile	Test site was clear and wet. Accumulation of snow on test site was delayed in comparison to control.
2/21/06 @ 6:00 p.m.	Wet snow, 1 to 3 in., PT = 20°F	1 application of solid chemicals at 200 lbs per lane mile (pre-wet)	Test site was clear and wet. Able to be kept that way with less chemical than control sections..
2/22/06 @ 5:45 p.m.	Snow, 1 to 2 in., PT = 27°F	1 application of solid chemicals at 200 lbs per lane mile (pre-wet)	Test site clear and wet, and “holding” longer than control sections.

Buffalo Creek Bridge, New York, and Davis Bridge, New York

Early results from these two bridges indicated that the overlay was meeting their specified goal “to evaluate the use of thin polymer overlays to extend the service of life of structural concrete decks. Secondary goals are product cost, ease of installation, material availability, and riding surface wear.”

The limited data provided from early in the winter suggest that the overlay on the two New York bridges performed well. In particular, events in early December when some light snow storms (in the range of 2 to 4 in. of snow) occurred, indicated that the overlay treated parts of the bridges stayed clear of sticking snow, and was not slick.

Wolf River Bridge, Crandon, Wisconsin

This bridge has had the overlay in place for three consecutive winters, and thus provides a longer history of operation than the other structures considered in this report. While the data for this structure is primarily anecdotal, it nonetheless has significant value. Typical treatments of the whole structure require 8 to 10 gal of anti-icing liquid at most. There are no problems with slickness unless “way too much” liquid is applied (it is surmised that this means significantly more than the 8 to 10 gal on the whole structure).

In typical winter weather, a single treatment or application of liquid has been effective against frost for 2 to 3 weeks. This is for a bridge that prior to the overlay being placed almost always exhibited frost if conditions were right. Thus, by a single application at a regular time of day every 2 to 3 weeks, the agency charged with maintaining the bridge has avoided early morning phone calls from local law enforcement officials saying “the bridge is icy” for the three winters since the overlay was installed. This, of course, represents a significant savings in overtime.

In addition to these savings in labor and equipment, there have been no wintertime accidents on the bridge since it was treated with the overlay in summer 2003. This compares with three to four accidents each winter prior to treatment. Two comments by the person charged with maintenance for the bridge (Ron Cole) indicate the value of the overlay. In the first instance he noted, “When the sun went down in the winter, the bridge used to freeze up—it just doesn’t do that anymore.” And as a summative comment on the overlay he noted, “It just does its job real well.”

IMPLICATIONS OF OBSERVATIONS

Four important implications are clear from the field observations reported from the 2005–2006 winter season. In making these observations, the author has attempted to take a prudent and conservative approach, noting that the results are based on only one winter of testing for the bridges discussed in detail herein. Given how winters vary not only from location to location but also from year to year, it would be foolhardy to attempt to generalize the results from one season’s testing to all winters in all possible winter weather locations. Notwithstanding these cautions, the following implications are noteworthy.

First, the SafeLane overlay caused no problems with winter maintenance operations. A particular concern here is that the overlay needs to be “charged” occasionally with liquid

chemicals. As noted above, under certain circumstances, these liquids may, in the process of drying out, create a slick or slippery condition. There were no reports of such slickness occurring on any of the test sections. It is noteworthy that in some cases, again as noted above, liquids were applied when temperatures were such that slickness might well have occurred. On the basis of these observations, it would appear, that for the chemicals used in the 2005–2006 season (primarily sodium chloride brine and magnesium chloride brine) there is not a problem of slickness associated with their placement.

Second, in a number of instances the SafeLane-treated test sections were observed to be clear of snow and/or ice when control sections had snow or ice on them. This observation is well documented for both the Blatnik installation and the Ironwood Bridge. In addition, anecdotal reports for both the Ironwood Bridge and for the McLean Bridge in Texas indicate that the test sections in both cases performed significantly better than the control sections. Specifically, the test sections remained clear of snow or ice under weather conditions when snow and ice were accumulating on control sections, and further, in the case of the McLean Bridge, were causing accidents.

Third, in cases where sufficient snow was falling that some accumulation was inevitable, it was observed that the SafeLane treated test sections could be kept clear with lower applications of chemicals, and that these applications prevented bonding as well as, and in some cases better than, the larger applications on the control sections. Specifically, for the Ironwood Bridge, there were a number of occasions on which lower applications of chemicals were made to the test sections and suitable response was obtained. This occurred with two applications on December 14, 2005, and two applications on February 12, 2006.

These latter two points are very significant for winter maintenance in two ways. First, one of two primary goals in winter maintenance is to ensure mobility on the highway during and after a storm. The SafeLane treated test sections did this on numerous occasions when untreated segments of highway allowed accumulations of snow and/or ice to occur. For example, for 11 in-storm treatments at the Ironwood Bridge (as opposed to anti-icing pre-treatments), the test section was clear of snow and ice without treatment for 10 of the 11 treatments. That means that traffic on the test section was unhindered by snow on the road for almost all the time. In contrast, for 10 of the 11 treatments the control section was reported as having either snow, slush, or ice present. No report was given for the 11th treatment occasion.

Further, the superior performance of the test section was achieved with significantly less chemicals than those applied to the control sections. Again, from the Ironwood Bridge, the test section for all reported treatments had liquid applied at the same rate as the control section, but while the control section had solid chemicals applied in total at a rate of 2,520 lb per lane mile, the test section had chemicals applied at a rate of 1,260 lb per lane mile. Thus superior performance was achieved on the test section with only 50% of the chemical used on the control section. This is a significant saving of chemicals, and will have both cost benefits and environmental benefits.

The final major implication of the reported observations from the 2005–2006 winter concerns safety, the other primary goal of winter maintenance. In this regard, reports from the McLean Bridge reported significant safety benefits during one winter event (specifically no accidents on the test section, while there were numerous accidents occurring elsewhere on the road). Of course, crashes occur in unpredictable patterns, so this observation in and of itself is not conclusive. However, it is bolstered by season-long observations at two other sites. At the Blatnik Bridge, which had observed about 20 crashes over the previous 4 years, no crashes were

observed. At the Interstate exit in Brecksville Ohio, it was noted that fewer crashes occurred on the exit this winter than in previous winters. For statistically significant results, safety studies need to be conducted over a number of years, but these observations suggest that the improved performance of the overlay under winter conditions discussed above does indeed translate into safety improvements for the traveling public.

CONCLUSIONS

The SafeLane overlay system was applied to a number of sites for evaluation during the 2005–2006 winter season. Observations at these sites allow the following preliminary conclusions to be made:

- The SafeLane overlay did not cause any problems with winter maintenance. In particular, no concerns with chemical slickness or slipperiness arose even though chemical was applied on some occasions under weather conditions where such slickness might have been a concern.
- Test sections remained clear of snow or ice under weather conditions when snow and ice were accumulating on control sections. In some circumstances these accumulations on control sections were sufficient to contribute to crashes.
- When accumulation did occur on the test sections, bonding of snow and ice to the pavement was not observed, and the accumulation could be controlled by plowing and application of chemicals. Further, the quantity of chemicals needed to obtain these good conditions was less on the test sections than on the control sections.
- One implication of the above two points is that SafeLane-treated segments of the highway infrastructure maintained mobility for longer, and could be returned to full mobility more easily than non-treated sections.
- A second implication of these two points is that bare pavement conditions could be maintained on the test sections with approximately 50% of the chemicals applied to control sections.
- Finally, while the data are preliminary, there is evidence that the improved performance of the SafeLane overlay under winter conditions discussed above does indeed translate into safety improvements for the traveling public.

Thus in conclusion it appears, on the basis of the observations made during the 2005–2006 winter, that the SafeLane overlay provides benefits in both safety and mobility under winter storm conditions, and that those benefits may be attained with less chemical than would be needed for highway segments without the overlay.

ACKNOWLEDGMENTS

The data and information reported herein could not have been collected without the assistance of Anthony Hensley and Bob Persichetti of Cargill, both of whom provided me with the pertinent contact information that I needed. This assistance is gratefully acknowledged. In addition, the willingness of a number of people to talk with me and share their insights made the report

possible. In this regard, I would like to thank Tom Konieczny and Steve Giese of Indiana DOT, Randall Petterson of Texas DOT, Tim Ujvari of the Ohio Turnpike Commission, Dan Roosevelt of the Virginia Transportation Research Center, Jeff Hall of Minnesota DOT, Anna Davey of Wisconsin DOT, Ron Cole of the Forest County Highway Commission, Wisconsin, and Charlie Smith of New York DOT. This help is gratefully acknowledged.

Providing Weather Information to Improve Driver Decisions

PROVIDING WEATHER INFORMATION TO IMPROVE DRIVER DECISIONS

Personal Weather Advisor*Providing Drivers with In-Vehicle, Real-Time Weather Awareness***DANIEL R. GALLAGHER****BOB BARON****BOB DREISEWERD***Baron Services, Inc.***JOHN MCHENRY****DON OLERUD***Baron Advanced Meteorological Systems*

Despite an increasing number of ways to transmit weather information to the public, each has its limitations as it pertains to drivers on the roadway. Forecasts, warnings, and advisories these days are available via television, radio, the internet, National Oceanic and Atmospheric Administration weather radio, cell phones, and personal digital assistants, among others. Some of these methods are unavailable to a driver while in transit. Those that are available may not update frequently enough and may not be specific enough for the driver to determine if his or her trip will be affected, especially if he or she is unfamiliar with the area. Images such as radar data may not be interpreted properly by the general public. In addition, complex graphical displays pose another risk due to the fact that it takes a driver's eyes off the road. Most important, though all of the above provide atmospheric conditions, the resulting pavement condition for the driver's route is not conveyed. In order to provide real-time, route-specific, in-vehicle awareness, Baron Services has developed Personal Weather Advisor as a method of alerting a driver of weather and its impact on pavement conditions. Complex weather information from multiple sources, including a 24/7 staff of meteorologists, Baron proprietary products, National Weather Service sources, and real-time, actual observations, is continuously processed and analyzed. All of the interpretation and processing is completed before being broadcast to the vehicle. Through a partnership with XM Satellite Radio, both the atmospheric weather information and the resulting pavement condition are transmitted via satellite (broadcasting in S-band) in the form of simple, audible, and visual alerts to the driver. Although the end result is simple, the process by which the weather information is derived is comprehensive and utilizes cutting edge technology and computing power. For example, up-to-the-minute information from forecasters, radar, mesoscale models, and observations is used to analyze precipitation type and amount. In determining pavement condition, a high-resolution, hydrological model called the Land-Surface Model is run over the continental United States and provides temperature and moisture at the surface. In the future, other data sources such as *Clarus* and Vehicle Infrastructure Integration may provide added value to the product.

PROVIDING WEATHER INFORMATION TO IMPROVE DRIVER DECISIONS

A Study on the Expression of Winter Road Information and Its Effects on Drivers' Travel Decision Making

YASUHIKO KAJIYA

MATSUDA YASUAKI

TETSURO MATSUSHIMA

Civil Engineering Research Institute for Cold Region

It is inevitable to provide road users with adequate information on winter road traffic in Hokkaido, Japan, since severe driving conditions such as slippery road and poor visibility due to snowstorm are found everywhere. This paper investigates the expression of winter road information and its effects on drivers' travel decision making, which resulted in the website user surveys conducted on the website of Northern Road Navi. The following results were obtained. (1) When visibility goes down below 500 m, road users consider changing their travel behaviors. When visibility is between 100 and 200 m, they decide to use alternate routes and some decide not to drive. When visibility is 100 m or less, most drivers decide not to drive. (2) Appropriately provided information on visibility and surface conditions helps drivers to choose less hazardous travel behaviors. (3) Willingness to change travel behavior is affected by how visibility information is presented. When visibility information is presented as images, road users show more willingness to choose less risky travel behaviors. (4) When surface condition is "very slippery ice," the sense of driving hazard is very strong.

Driving conditions in cold, snowy regions such as Hokkaido, Japan, vary from hour to hour in winter because of weather and traffic conditions: snowstorms cause poor visibility, and road surfaces become very slippery. These changes in the driving environment greatly affect the travel behavior of drivers, and thus information on road conditions must be adequately provided. Enhancement of provided information would help road users to decide on safer travel behaviors, such as deciding to use alternative routes, to change the departure time, and the like.

The authors conducted a survey of road users' willingness to change their travel behavior according to how information on visibility and road surface conditions is provided. Information on these two items is considered particularly important winter road information. This study is based on a questionnaire survey of road users conducted on the Northern Road Navi website, a portal website on roads in Hokkaido (Figure 1). The study reports how road users' willingness to change their travel behavior is influenced by how road information is provided, and how information on road conditions affects road users' judgment of driving hazard.

SURVEY OUTLINE

A questionnaire survey of road users was conducted on the Northern Road Navi website for the 34 days from March 8, 2006. The website provides information on roads and travel in Hokkaido and is operated by Civil Engineering Research Institute for Cold Region under the supervision



FIGURE 1 Northern Road Navi website (<http://northern-road.jp/navi/>).

of Hokkaido Regional Development Bureau, Hokkaido Government, Sapporo City and East Nippon Expressway Co., Ltd. The questionnaire and the attributes of the respondents are outlined in Table 1.

Important Information for Road Travel in Winter

The questionnaire asked the respondents to indicate the information they regard as most important with respect to rural driving in winter.

Willingness to Change Travel Behavior According to How Visibility and Surface Condition Are Expressed

Road users’ willingness to change their travel behavior was surveyed to determine the most appropriate way of providing information on visibility and surface condition—road and travel information that previous studies have identified as particularly important (1, 2). Information was given in three ways: A, text label; B, text label and road image; and C, text label, road image, and text explanation. We call these Patterns A, B, and C.

TABLE 1 Questionnaire Outline and Respondent Attributes

Survey method	Web survey on the Northern Road Navi
Survey period	March 8, 2006, to April 10, 2006 (34 days)
Number of questions	10
Respondents	301 respondents (within Hokkaido)
Gender	Male 81%; female 19%
Age	10s = 1%; 20s = 20%; 30s = 37%; 40s = 27%; 50s = 10%; 60s = 4%; 70s = 1%
Frequency of driving	“Almost every day” accounted for greatest percentage (71%)
Years of driving experience	“11–20 years” accounted for greatest percentage (35%)

Willingness to change travel behavior according to how information is expressed was surveyed. This research focused on travel behavior intended to counter the risks posed by poor visibility and poor surface conditions. The respondents were asked to choose from five behaviors: “I would not change my travel behavior” (the least cautious behavior) to “I would think about canceling my trip” (the most cautious behavior) (Figure 2).

Figure 3 and Figure 4 respectively show how visibility and surface condition were presented to the respondents.

Influence of Information on Visibility and Surface Condition on Judgement of Driving Hazard

The survey also sought to clarify how information on visibility and surface condition influences the road user’s judgment of driving hazard.

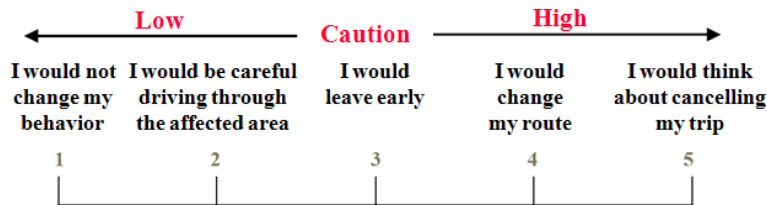

FIGURE 2 Travel behaviors.

Pattern A	Pattern B		Pattern C		
Text	Text + Image		Text + Image + Comment		
Visibility Rank	Visibility Rank	Image Example	Visibility Rank	Image Example	Explanation Comments
Good (1000- m)	Good (1000- m)		Good (1000- m)		You can see long distance and mountain, hill and building so far
Fair (500-1000 m)	Fair (500-1000 m)		Fair (500-1000 m)		You can see road alignments and roadside trees clearly
Poor (200-500 m)	Poor (200-500 m)		Poor (200-500 m)		You can easily recognize bad visibility from driver's seat
Very Poor (100-200 m)	Very Poor (100-200 m)		Very Poor (100-200 m)		You can manage to see road alignments and running vehicles ahead
Extremely Poor (-100 m)	Extremely poor (-100 m)		Extremely poor (-100 m)		You can see a little road alignments and running vehicles ahead, but sometimes and in some places visibility goes down under 100 m

FIGURE 3 Ways of expressing visibility.





















Pattern A	Pattern B		Pattern C		
Text	Text + Image		Text + Image + Comment		
Road Surface	Road Surface	Image Example	Road Surface	Image Example	Explanation Comments
Dry	Dry		Dry		Road surface is dry without snow and ice
Wet	Wet		Wet		Road surface is wet with water
Snow (Packed)	Snow (Packed)		Snow (Packed)		Road surface is covered with snow. Snow packed by tire is called "Packed snow"
Ice	Ice		Ice		Ice surface without gross. It can change into "Very Slippery Ice" with temp. and traffic effects
Very Slippery Ice	Very Slippery Ice		Very Slippery Ice		So-called "Very Slippery Ice" with gross surface. You can easily slip even if driving at low speed

FIGURE 4 Ways of expressing surface condition.

Figure 5 is the matrix of visibility and surface condition images that was shown to the respondents. There are 5 levels of visibility and 5 levels of surface conditions, and the respondents were asked to score the driving hazard for each combination.

Figure 6 shows the seven-point scale given to the respondents for scoring driving hazard, from "1. I can drive at ease" to "7. I feel danger." As a standard, the combination "good visibility / dry surface" (the combination of best visibility and surface conditions) was given a score of "1.0."

		Visibility				
		 Good (1000- m)	 Fair (500-1000m)	 Poor (200-500m)	 Very Poor (100-200m)	 Extremely Poor (-100m)
Road Surface	 Dry	1.0 (Fixed)				
	 Wet					
	 Snow					
	 Ice					
	 Very Slippery Ice					

I can drive at ease

Grade 25 boxes based on the rating scale below

FIGURE 5 Surface conditions combined with visibility (two-factor combination).

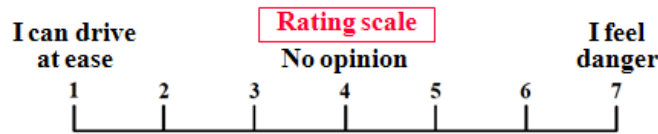

FIGURE 6 Scale for expressing driving hazard.

SURVEY RESULTS

Important Information for Road Traveling in Winter

Figure 7 shows the results of a questionnaire on what information is most important for driving on rural roads in winter. About 90% of the road users responded that information on visibility and surface condition is the most important.

Influence of Visibility Information on Willingness to Change Travel Behavior

Visibility and Change in Travel Behavior

Figure 8 shows how the respondents would change their travel behavior after receiving visibility information in three patterns: A, B, and C. The respondents tend to choose more cautious travel behaviors as visibility decreases, regardless of how the information is provided.

Regardless of how the information is provided, when visibility is roughly 500 m, the respondents consider changing their travel behavior, such as by departing earlier to allow enough time for travel. When visibility is 100 to 200 m, respondents decide to take alternate routes, and some even decide not to drive. When visibility is less than 100 m, 40% to 60% of respondents answered they would not drive.

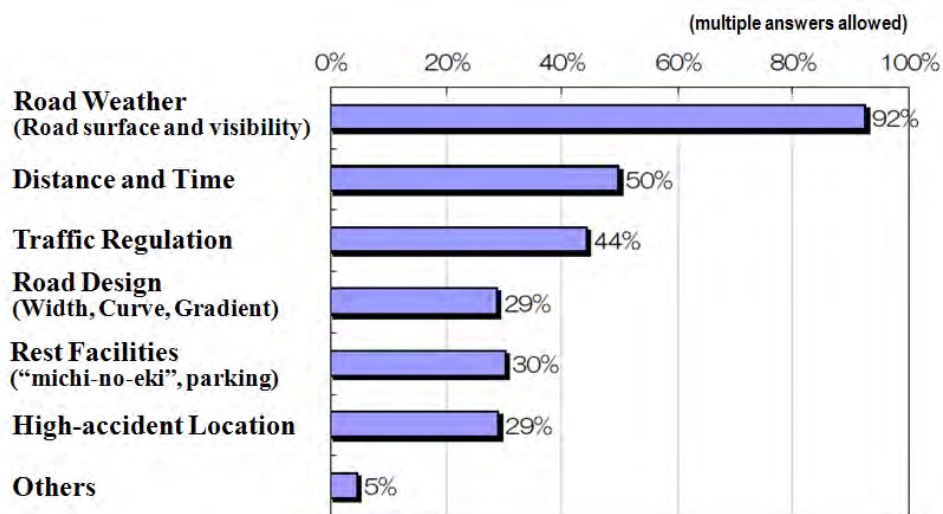

FIGURE 7 Important information when driving in winter.

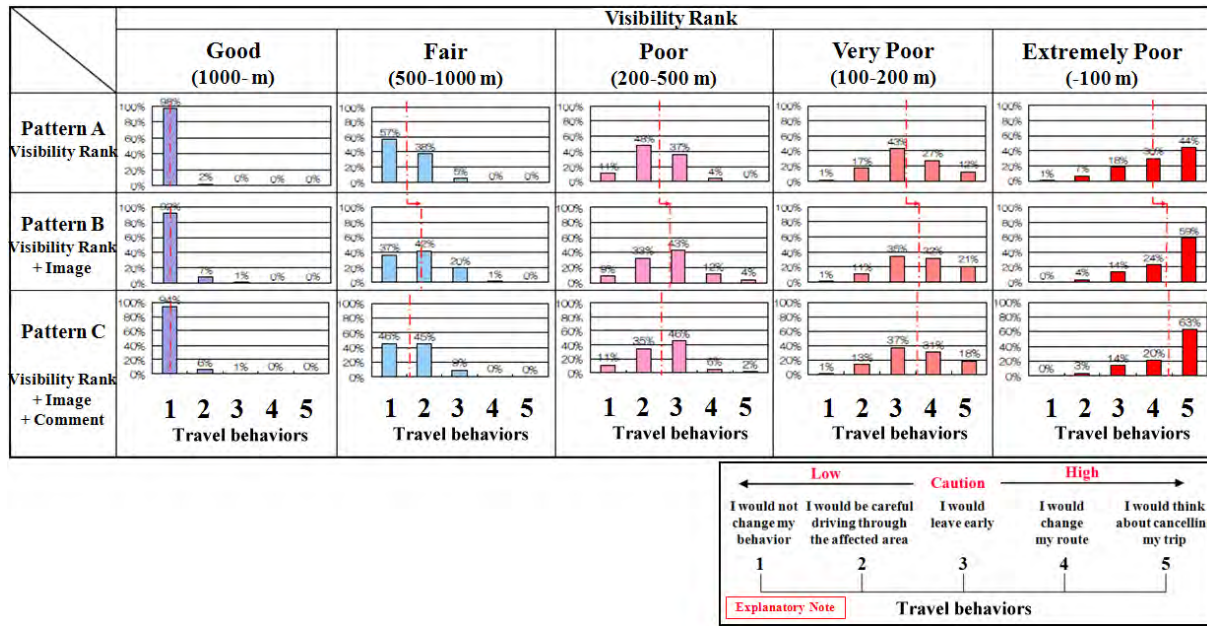

FIGURE 8 Visibility information and travel behavior decision.

Influence of Pattern of Visibility Information Provision on Willingness to Change Travel Behavior

Figure 8 also shows that the respondents, for the same degree of visibility, choose more cautious travel behaviors when visibility information is given as text label and image (Pattern B) than when it is given as text label only (Pattern A). It is thought that providing visibility information in the form of road image enabled respondents to judge road conditions more accurately and realistically than in the form of text label alone and prompted them to consider changing their travel behavior to avoid risks.

Influence of Road Surface Information on Willingness to Change Travel Behavior

Surface Condition and Change in Travel Behavior

Figure 9 shows how respondents would change their travel behavior after receiving surface information in three patterns of information provision. They tend to choose more cautious travel behaviors as the surface condition deteriorates, regardless of how the information is provided. Nearly 25% of the respondents say they would consider using an alternate route and more than 10% say they would not drive if the road surface condition deteriorated from “snow (packed),” a common winter road condition in Hokkaido, to “ice,” regardless of how the information was provided.

For the “very slippery ice” road surface condition, 30% to 40% of respondents say they would not drive. This is the road surface condition for which the greatest number of respondents answered that they would not drive.

Influence of Pattern of Road Surface Information Provision on Willingness to Change Travel Behavior

Figure 9 also shows that travel behavior did not differ greatly by how the surface condition information was provided. This differs from the results for visibility. In other words, travel behavior is not affected by the addition of road images or text explanations to text labels of surface condition. This is attributed to the fact that, whereas visibility tends to change continuously, surface condition changes in a phased manner, which makes it possible for the driver to understand the road situation from text label information alone.

Intelligibility of Text Explanations

The respondents were also asked about the intelligibility of the text explanations of visibility and surface condition. The results are shown in Figure 10 and Figure 11. About 70% of the respondents said the text explanation of visibility was intelligible, whereas only 50% of respondents said the explanation of surface condition was intelligible. Many respondents requested that the degree of slipperiness be explained more understandably.

Influence of Visibility and Road Surface Condition on the Driving Hazard

The driving hazard perceived by road users was surveyed for various combinations of visibility and surface condition, and the results are shown in Figure 12. The respondents were asked to assign a score for driving hazard according to the scale shown in Figure 6. Scores of 4 or greater mean that the respondents find driving hazardous. The figure shows that road users consider it hazardous to drive under most of the visibility and surface conditions that occur in winter.

Figure 13 shows the mean score for each combination of surface condition and visibility from Figure 12. Respondents feel that it is very dangerous to drive when the surface condition is “very slippery ice,” regardless of visibility.

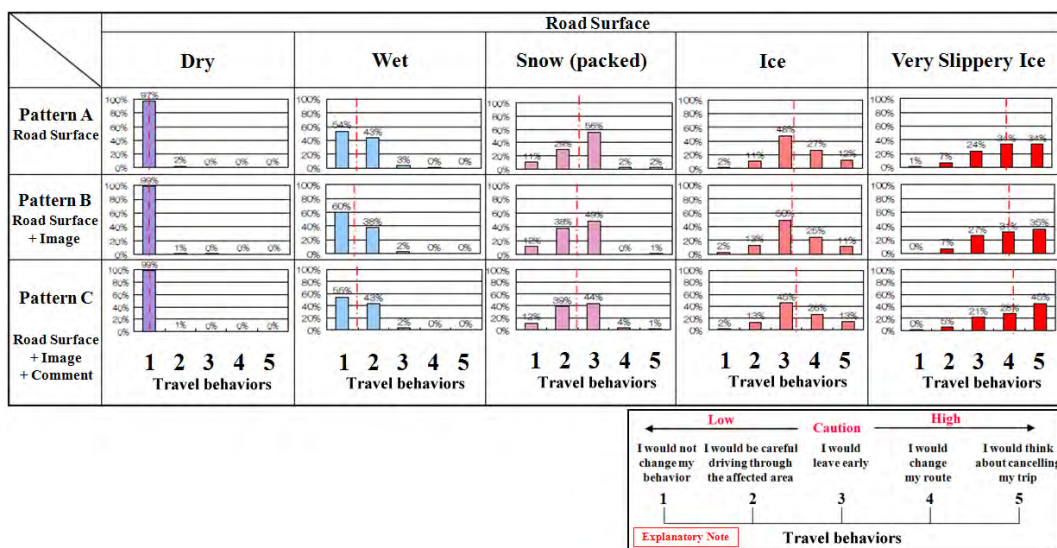

FIGURE 9 Road surface information and travel behavior decision.

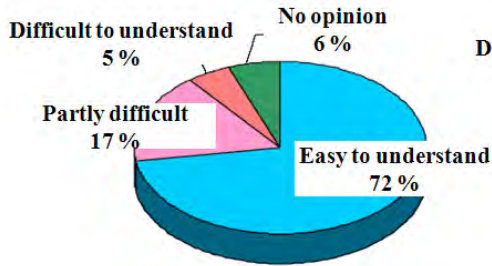

FIGURE 10 Intelligibility: explanation of visibility.

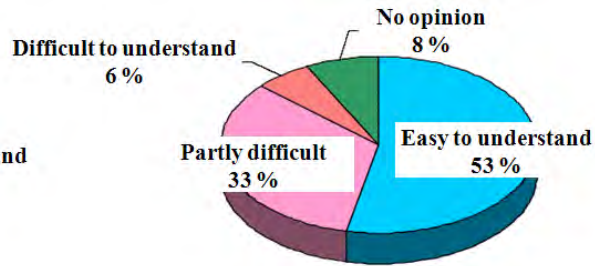

FIGURE 11 Intelligibility: explanation of surface condition.

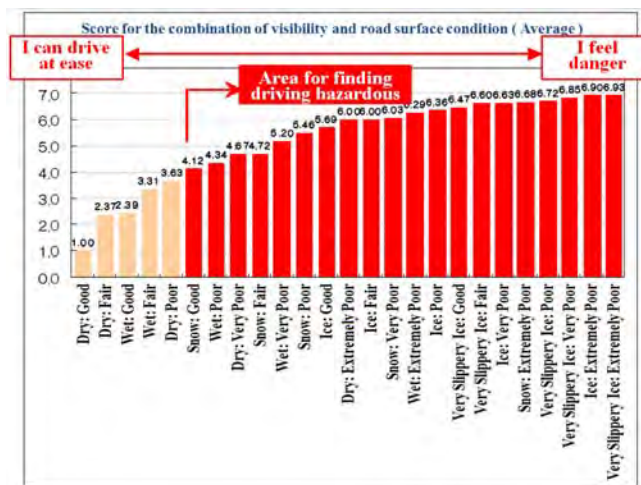

FIGURE 12 Driving hazard scores.

		Visibility				
		Good (1000-m)	Fair (500-1000m)	Poor (200-500m)	Very Poor (100-200m)	Extremely Poor (<100m)
Road Surface	Dry	1.0	2.4	3.6	4.7	6.0
	Wet	2.4	3.3	4.3	5.2	6.3
	Snow	4.1	4.7	5.5	6.0	6.7
	Ice	5.7	6.0	6.4	6.6	6.9
	Very Slippery Ice	6.5	6.6	6.7	6.9	6.9

FIGURE 13 Matrix of driving hazard scores.

CONCLUSIONS

The questionnaire survey of road users done on the Northern Road Navi website clarified the following:

Influence of Pattern of Road Information Provision on Willingness to Change Travel Behavior

- The most important information for drivers in winter is information on visibility and surface conditions.
- When visibility is roughly 500 m, road users consider changing their travel behavior. When visibility is between 100 and 200 m, they decide to use alternate routes and some decide not to drive. When visibility is 100 m or less, most drivers decide not to drive.
- When the surface condition changes from snow (packed) to ice, road users use alternate routes and some decide not to drive. When the surface condition is very slippery ice, most drivers decide not to drive.
- Appropriately provided information on visibility and surface conditions helps drivers to choose less hazardous travel behaviors.
- Willingness to change travel behavior is not greatly affected by how surface condition information is provided. However, willingness to change travel behavior is affected by how visibility information is presented. When visibility information is presented as images, road users show more willingness to choose less risky travel behaviors.

Influence of Information on Visibility and Surface Condition on Judgment of Driving Hazard

- Under most of the visibility and road surface conditions that occur in winter, road users find it difficult or dangerous to drive.
- When surface condition is very slippery ice, sense of driving hazard is very strong.

IMPROVEMENTS AFTERWARDS AND FUTURE PROSPECTS

On the basis of this study, the authors enriched the contents of winter road information on Northern Road Navi website using more images than ever. Specifically, we increased the number of images on mountain pass information page (Figure 14), introduced motion and still images for explaining severe winter road conditions to the winter driving guide (Figure 15). In addition, we improved the distance and travel time search function to easily access images of the mountain passes on the route (Figure 16). These improvements helped drivers to judge winter road conditions more accurately and choose less risky travel behaviors.

As future prospects, we would like to investigate the effect of these improvements on road users' travel behavior and the value for money of advanced winter road information.

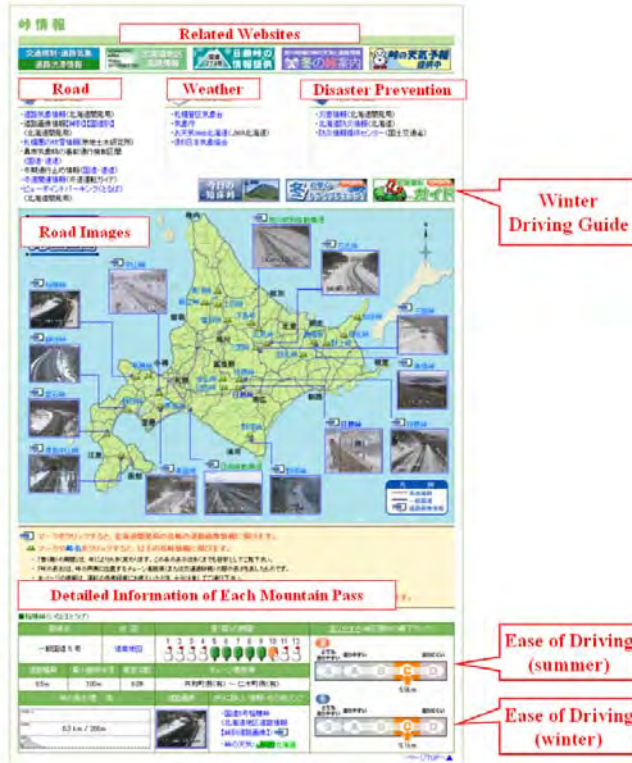

FIGURE 14 Increasing number of images on mountain pass information page (Northern Road Navi website).



FIGURE 15 Introducing motion and still images to the winter driving guide (Northern Road Navi website).



FIGURE 16 Easy access to images of the mountain passes on the route (new distance and travel time search function of Northern Road Navi website).

ACKNOWLEDGMENTS

In the questionnaire survey conducted via the Northern Road Navi website, Hisaaki Masaoka and Hiroshi Hoshino of C. E. Service Company Limited provided a great deal of assistance. In addition, we would like to extend our appreciation to the respondents of the questionnaire survey, as well as to members of the Hokkaido Society for the Study of Road Information, for their assistance in operation of the Northern Road Navi website.

REFERENCES

1. Matsushima, T., Y. Matsuda, et al. Provision of Information in Winter and in Natural Disasters. Monthly Report of Civil Engineering Research Institute for Cold Region, November 2006 (in Japanese).
2. Kajiya, Y., et al. Building a Brand and Analyzing Needs for Northern Roads through Website Operation. Presented at 4th ITS Symposium 2005, December 2005 (in Japanese).

PROVIDING WEATHER INFORMATION TO IMPROVE DRIVER DECISIONS

Driving Decisions Related to the Colorado Front Range Winter Storm, December 20–21, 2006

SHELDON DROBOT

Colorado Center for Astrodynamics Research, University of Colorado

In an average year, winter weather is directly or indirectly involved in 400,000 vehicular accidents in the United States, leading to 1,300 fatalities and 118,000 injuries. To improve our understanding of decision making related to driving in hazardous winter weather conditions, this study investigated driving decisions related to a winter storm that occurred along the Colorado Front Range on December 20–21, 2006. The results suggested that most respondents relied on local television to get weather information leading up to and during the storm, highlighting the important role local broadcast meteorologists play in conveying information to the general public during major meteorological events. Additionally, a higher percentage of the respondents stayed home based on the weather forecast in comparison with previous research, probably related to the combination of the forecast severity and specific warning language related to hazardous driving conditions. Respondents who stayed home were more likely to have higher levels of self-reported anxiety related to driving in weather conditions, which reinforces the notion that decision making related to hazardous weather events is not solely related to meteorological forecasts or conditions. Finally, a majority of respondents felt that the snow began to fall approximately when it was forecast to begin, but a majority of respondents believed that more snow fell than was actually forecast. Verification of these measures is difficult, but analysis of the National Weather Service forecasts suggests that both the timing and snowfall accumulation were reasonable, especially the last few updates prior to December 20.

When faced with winter weather conditions, people generally state that they will reduce their speed and drive with greater caution (1). Nonetheless, research also shows that the risk of vehicular accidents rises sharply in winter weather conditions (2), suggesting people's responses are not sufficiently accounting for the weather conditions. In fact, in an average year, winter weather is directly or indirectly involved in 400,000 vehicular accidents in the United States, leading to 1,300 fatalities and 118,000 injuries (3); these numbers far exceed average fatalities for other natural hazards (4).

Despite the high incidence of morbidity and mortality, relatively little is known about how the combination of weather forecasts, observed weather, and nonmeteorological factors combine to influence driving decisions in winter weather conditions. Yet this integration of physical and social science information is critical to develop new weather forecast information dissemination strategies and to design new accident countermeasures (1, 5).

To improve our understanding of decision making related to driving in hazardous winter weather conditions, this study investigated driving decisions related to a winter storm that occurred along the Colorado Front Range on December 20–21, 2006. This winter storm provides an intriguing case study from both physical and societal standpoints. Physically, the storm ranked as one of the largest ever seen along the Colorado Front Range. Societally, because snow did not begin falling heavily until midmorning, people's decisions to stay home would have been

based largely on weather forecasts. The latter is key because it is not well understood what percentage of people cancel trips based on weather forecasts versus current conditions (1, 6, 7). Specifically, this report investigates the following research questions:

1. What were respondents' main sources for obtaining weather information for the December 20–21, 2006, winter storm?
2. Did respondents decide to stay home on December 20, and if so, what information and characteristics influenced that decision?
3. What were the respondents' perceptions of the accuracy of the weather forecast?

Answers to these questions can provide critical insight into the public's sources, uses, and perceptions of weather information, and also how they make decisions related to driving during hazardous events.

DATA COLLECTION AND ANALYSIS METHODS

Information on respondents' sources, uses, and perception of weather forecasts, their driving decisions related to the December 20–21, 2006, winter storm, and their basic demographic characteristics were obtained via an Internet survey. Working through Survey Sampling International (www.surveysampling.com/), I obtained 254 responses over a 3-day timeframe from respondents living along the Colorado Front Range.

Internet sampling is an attractive alternative to traditional mail surveys because it provides data rapidly and it allows for better control over respondents' access to the questions (i.e., they cannot jump ahead or go back and change their answers based on information in a subsequent question). However, there remains a significant portion of the U.S. population that does not have access to the Internet (8). Estimates of Internet access vary widely, but based on the most recent U.S. Census data (2003), about 55% of U.S. households ($n \sim 62$ million) have Internet access at home. To ensure that a large portion of these households is eligible for surveying, Survey Sampling International recruits possible survey panelists through thousands of websites as well as data aggregators. Combined, Survey Sampling International estimates that they have access to about 70% of the online population. Regardless, it is important to keep in mind that the Internet survey data are for exploratory purposes and are not representative of the entire population of the Colorado Front Range or the rest of the United States.

Table 1 presents selected socioeconomic and demographic characteristics of the respondents. In comparison with U.S. Census information for the state of Colorado, the response pool for this survey contained a higher portion of females, was slightly better educated, and was wealthier.

MAJOR FINDINGS

Research Question #1: What were respondents' main sources for obtaining weather information for the December 20–21, 2006, winter storm?

Looking first at respondents' everyday sources for obtaining weather information, responses highlight the importance of local television stations and also suggest some newer technologies are not yet used by the majority of the respondents. For instance, 90% of the respondents obtain weather forecasts from local television stations at least once a week (Figure 1), but cell phones are used for obtaining weather forecast information at least once a week by less than 5% of the respondents.

TABLE 1 Selected Characteristics of the Respondents

Characteristic	Number	Survey Sample	Census ^a
Gender			
Male	100	43%	52%
Female	135	57%	48%
Education			
Did not complete high school	2	1%	11%
High school diploma or equivalent	26	11%	24%
Some college, two-year college degree, or technical school	110	47%	22%
4-year college graduate	55	24%	29%
Master's degree	29	12%	9%
Professional degree or doctorate	11	5%	4%
Race			
White	212	83%	84%
Black or African American	7	3%	4%
Hispanic	13	5%	N/A ^b
Asian	4	2%	3%
American Indian	4	2%	1%
Other	3	1%	7%
Income			
Less than \$10,000	5	2%	7%
\$10,000 to \$49,999	79	34%	42%
\$50,000 to \$99,999	109	47%	32%
\$100,000 or more	40	17%	18%

^a Based on the 2005 American Community Survey from the U.S. Census Bureau for the state of Colorado.

^b The U.S. Census does not define Hispanic as a race.

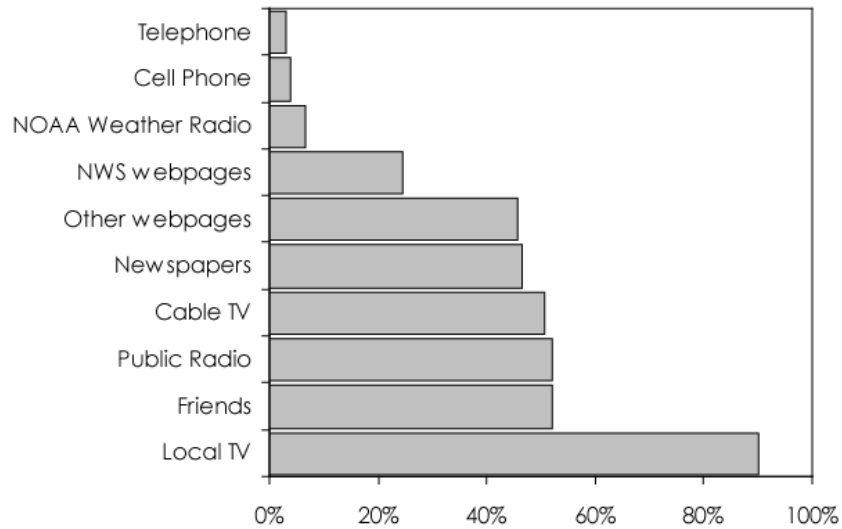

FIGURE 1 Percentage of respondents who obtain weather forecast information from various sources at least once a week. Respondents could select all that apply.

Focusing specifically on respondents' sources of weather information related to the December 20–21, 2006, winter storm, there is a clear preference for local television. Nearly 2/3 of respondents used local television as their main weather forecast information source leading up to the storm, and during the storm, 76% of respondents tuned into the local television stations as their main information source (Figure 2).

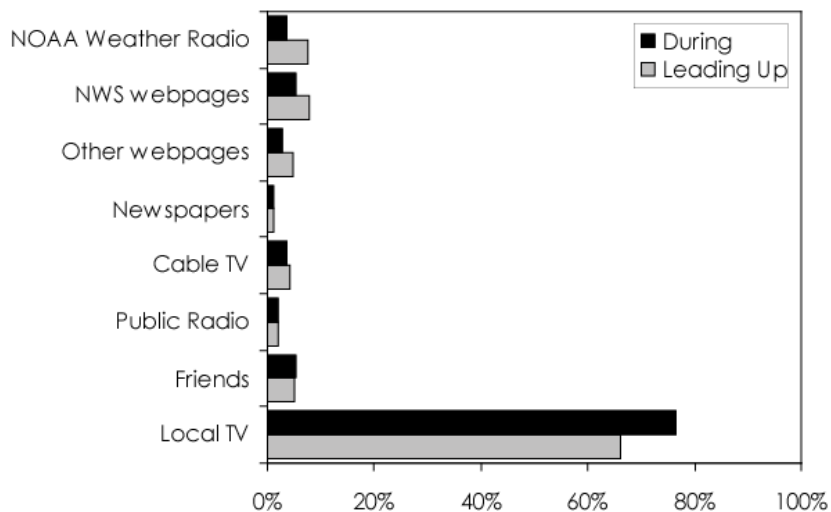

FIGURE 2 The main information sources for obtaining weather forecast information leading up to and during the December 20–21, 2006, winter storm. Respondents could only select one information source.

Combined, these results emphasize that local television remains the dominant source for obtaining everyday weather forecast information, and it appears to take on added significance for long-lead hazardous weather events. Although the options for obtaining weather forecast information have increased due to new technologies, such as the Internet and cell phones, these newer sources are not yet used as the main source for obtaining weather forecast information by many of the respondents. Moreover, these results support previous studies that highlight the important role local broadcast meteorologists play in conveying information to the general public during major meteorological events (9), and the results further emphasize the importance of public–private sector relationships (10).

Research Question #2: Did respondents decide to stay home on December 20, and if so, what information and characteristics influenced that decision?

As noted in the introduction, an interesting facet of this winter storm was that snow had only begun to lightly fall, or had yet to begin falling, during the December 20 morning commute. However, within a few hours, peak snowfall rates had reached 2 to 3 in. per hour, and by evening snow accumulation was greater than 1 to 2 ft in many locations. The high snowfall rates resulted partly from strong jet-stream winds and very cold upper atmosphere temperatures, which led to considerable upward motion. Additionally, atmospheric motion in the lower atmosphere favored moisture advection from the Gulf of Mexico and upslope flow on the eastern Rocky Mountains, further contributing to the heavy snowfall rates.

Overall, 48% ($n = 119$) of the respondents left home for work or school on the morning of December 20, 2006, and 52% ($n = 128$) stayed home. Of those who stayed home, 65% attributed their decision to stay home as being based on the weather forecast. Thus, roughly one in three respondents stayed home based on the weather forecast. These results provide empirical evidence that people will cancel trips during severe weather based on weather forecasts, which deviates from the general consensus that driving decisions are based mainly on previous experience and observable weather, with weather forecasts playing very little role in driving decisions (6, 7). Although additional studies are needed to better determine why these results differ somewhat from accepted wisdom, the most likely explanation relates to the severity of the forecast December 20–21, 2006, winter storm. For instance, most existing studies deal with general winter driving conditions, but they do not focus specifically on situations of severe winter weather conditions, as were forecast for this storm. Beginning with the first winter storm watch, and extending through the winter storm warning and blizzard warning, the National Weather Service (NWS) repeatedly warned that travel would be treacherous and impossible in some areas (Table 2). For example, the December 19 (Tuesday) forecast at 5:17 a.m. noted that “travel may become difficult if not impossible due to heavy falling and blowing snow,” and the 11:29 a.m. update suggested that “[p]ersons planning travel on Wednesday or Thursday should consider alternate plans.” The survey design did not allow for elaboration on what parts of the weather forecast prompted respondents to stay home, so it is not possible to state with certainty what role these transportation warnings played. However, these messages, which were subsequently conveyed through television, radio, and other sources, may have been an important factor in respondents’ decision to stay home on December 20.

TABLE 2 Selected Noted from NWS Forecasts and Updates

Date and Time	Advisory Notes	Transportation Notes
Dec. 19 (4:11 a.m.)	Winter storm watch issued	Persons planning travel across Colorado should be prepared for hazardous driving conditions beginning today in southern Colorado and then across the entire state late tonight through Wednesday night.
Dec. 19 (5:17 a.m.)		Travel may become difficult if not impossible due to heavy falling and blowing snow.
Dec. 19 (11:29 a.m.)		This storm will have potential to produce 10 to 20 in. of snow from the front range east across the plains...Persons planning travel on Wednesday or Thursday should consider alternate plans...such as leaving earlier or delaying travel until Friday. Dangerous winter storm conditions are expected and road closures are possible.
Dec. 19 (12:10 p.m.)	Winter storm watch switches to winter storm warning	
Dec. 20 (4:21 a.m.)	Winter storm warning switches to blizzard warning	Travel will become extremely hazardous if not impossible later this morning. Travel is simply not recommended today through early Thursday morning. Travel will be extremely dangerous and is discouraged in these whiteout conditions. If you must travel...have a winter survival kit with you. If you get stranded...stay with your vehicle and wait for help to arrive.
Dec. 20 (12:04 p.m.)		Travel is rapidly becoming extremely hazardous and will likely become impossible this afternoon.

Focusing on the people who left home, a series of questions asked these respondents whether or not they took special precautions on the morning of December 20, 2006 (as suggested by the NWS); the respondents could indicate they did nothing or they did some combination of packing extra food, clothes, or winter gear. Overall, 70% of those who left did not take any extra precautions before leaving. Only 8% packed extra food in their vehicle before leaving, 17% packed extra clothes in their vehicle before leaving, and 20% packed winter gear in their vehicle (e.g., shovels, candles, etc.). The low rate of self-preparation presents an opportunity to make a concerted educational effort at better explaining the need to prepare before leaving home. As most respondents are relying on local television sources for weather forecasts, especially during severe weather (Figures 1 and 2), broadcast meteorologists are well positioned to strongly and repeatedly advise the public that should they need to leave, they had best take extra food, clothing, etc., as a precaution.

For those who left home, other questions asked about whether or not they left work early, and how long their commute home took. Only 24% left work or school at about same time as they always did; 37% left work or school early based on their own decisions; and 39% of the respondents left early because their place of work or school closed. The modal category for a typical commute home of survey respondents was between 15 and 30 min (Figure 3), but the modal commute time during the storm was between 60 and 90 min, and 22% of the respondents took more than 2 h to get home. Moreover, with the heavy snowfall rates, roads quickly became difficult to traverse, and 7% of the respondents became stuck in the snow on the trip home. For

those that were stuck, an open-ended question asked them to describe what they did next. Several respondents were able to extricate themselves on their own or with the help of Good Samaritans, but a few people abandoned their vehicles and either were given rides home by police or fire, or simply walked home if they were close. The time of day respondents left work had little relationship with the length of their commute or whether or not they became stuck on the trip home. This most likely is related to the very high snow accumulation rates, which would have created transit problems early in the day.

In addition to focusing on respondents' actions on the morning of December 20, other questions were asked to assess how nonmeteorological and meteorological factors combined to influence decision making. For example, existing research indicates that weather conditions are the main source of anxiety for drivers (11), and recent research suggests some links between posttraumatic stress disorder (PTSD) and driving behavior in flash flood situations (12). Although the current study did not ask questions related to the clinical definition of PTSD, there is evidence from this survey to state that as self-reported anxiety levels related to driving in hazardous weather increased, the percentage of respondents staying home also increased (Figure 4). With increased anxiety, respondents would likely feel less capable of keeping themselves safe while driving in the winter storm (i.e., lower safety efficacy), and thus they would be more likely to choose to stay home (13).

Research Question #3: What were the respondents' perceptions of the accuracy of the weather forecast?

The majority of respondents (56%) felt that the snow began to fall approximately when it was forecast to begin (Figure 5). In comparison, 30% believed that snowfall began sooner than expected, 7% felt that snow began to fall later than forecast, and 7% did not know when the snow was supposed to begin falling. Although it is difficult to verify the onset of snowfall, especially given that snow began falling at different times over the study region, the NWS

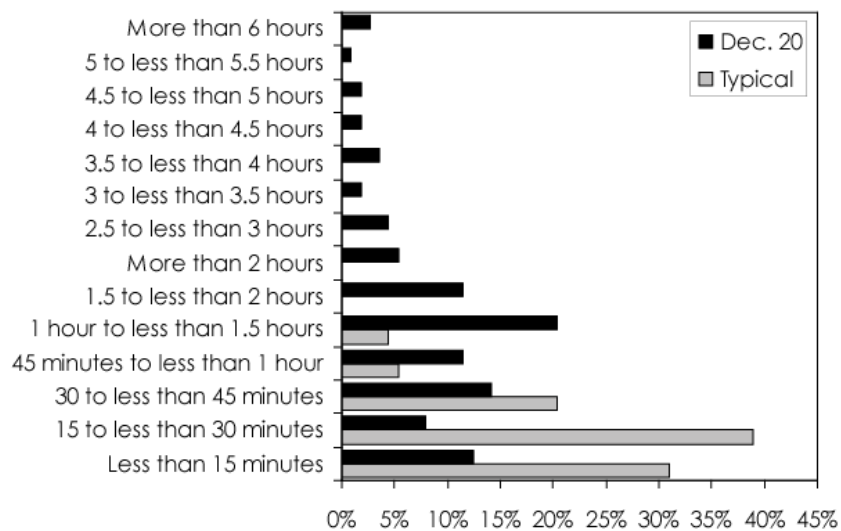

FIGURE 3 Frequencies of respondents' typical and December 20, 2006, commute times.

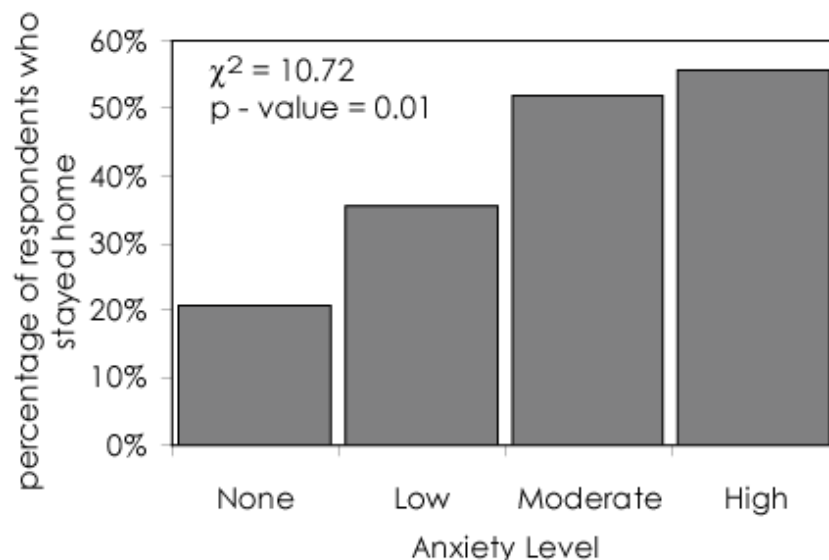

FIGURE 4 Percentage of people who stayed home on December 20, 2006, based on their self-reported level of anxiety related to driving in hazardous weather conditions.

forecast discussions as early as December 17, and continuing into December 19, noted that snowfall should begin on December 20.

Although most respondents felt that the timing of the snowfall was accurate, a majority of respondents believed that more snow fell than was actually forecast (Figure 6). Given the spatial variability in snowfall accumulation, and because it is not certain where individual respondents obtained their weather information, this is again difficult to verify. However, the NWS forecast discussions leading up to December 20 provide evidence that significant snowfall accumulation was expected, especially in the December 19 afternoon discussion.

Comparing the two measures, there is a strong association between respondents' perceptions of timing and amount of snowfall. Approximately 78% of the respondents that felt snowfall began about when it was forecast also felt that the forecast snowfall was accurate. In comparison, of those that felt more snow fell than was forecast, 44% felt it also began earlier (45% felt it began on time). All respondents that did not know whether the actual and forecast snowfall amounts were about the same also did not know when snow was forecast to begin falling.

Certain characteristics are associated with those that felt more snow fell than forecast. For example, 60% of respondents who left home on the morning of December 20 thought that more snow fell than was forecast, compared with 52% of those who stayed home ($\chi^2 = 6.41$; p -value = 0.09). Those who stayed home were also more likely to state that less snow fell than was forecast (7% versus 3%), although the numbers are small for these two categories. Of the 17 people who became stuck on their way home, an even larger percentage (70%) felt more snow fell than was forecast. The latter result suggests that people's perceptions of forecast accuracy may be related to how much they're impacted by the weather; this is an area for additional research in follow-on studies.

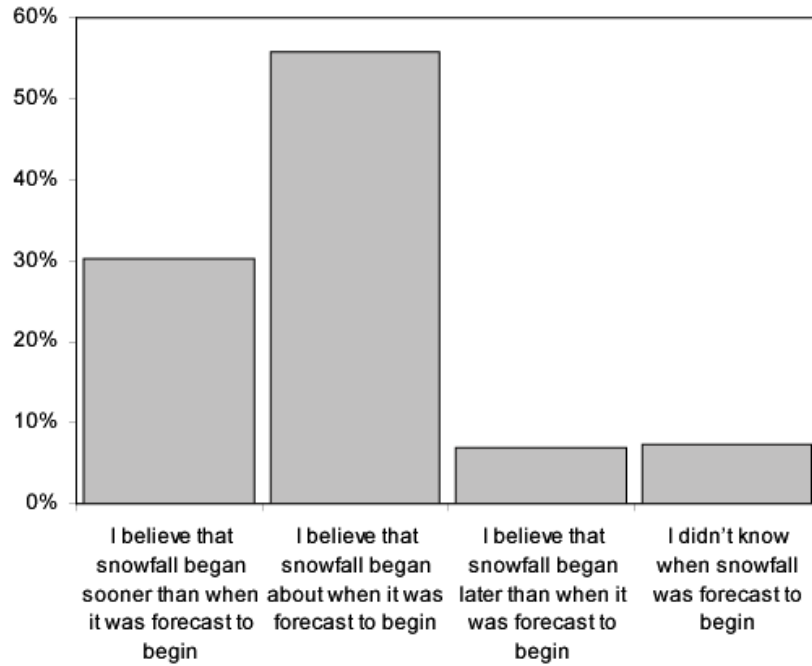

FIGURE 5 Respondents' perceptions of the timing of the beginning of snowfall on December 20, 2006.

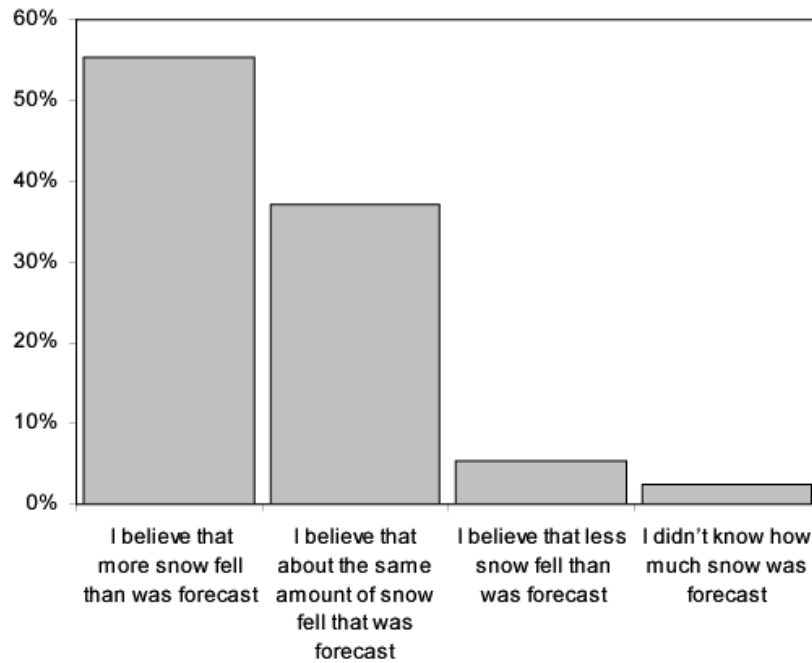

FIGURE 6 Respondents' perceptions of the amount of snowfall during the December 20–21, 2006, winter storm.

SUMMARY AND CONCLUSIONS

This report focused on identifying respondents' everyday sources for obtaining weather information; their main sources for obtaining weather information for the December 20–21, 2006, winter storm; determining what percentage of respondents stayed home on the morning of December 20, 2006, and whether their decision to stay home was based on the weather forecast and/or certain defining characteristics; and assessing respondents' perceptions of the accuracy of the weather forecast. The following results emerged:

- The vast majority of respondents relied on local television to get weather information leading up to and during the storm, highlighting the important role local broadcast meteorologists play in conveying information to the general public during major meteorological events, and further emphasizing the importance of public-private sector relationships.
- A higher percentage of the respondents stayed home based on the weather forecast in comparison with previous research. Additional research is needed to fully explain this, but the combination of the forecast severity and specific language related to hazardous driving conditions may have contributed to the higher-than-expected percentage of people who stayed home.
- Respondents who stayed home were more likely to have higher levels of self-reported anxiety related to driving in weather conditions. This reinforces the notion that decision making related to hazardous weather events is not solely related to meteorological forecasts or conditions. It also highlights the importance of incorporating physical and social sciences in any attempt to understand the public reaction to hazardous weather events.
- Only 30% of respondents who left home took special precautions, such as packing extra food or clothes. This highlights an area where additional public education is needed.
- A majority of respondents felt that the snow began to fall approximately when it was forecast to begin, but a majority of respondents believed that more snow fell than was actually forecast. Verification of these measures is difficult, but analysis of the NWS forecasts suggests that both the timing and snowfall accumulation were reasonable, especially the last few updates prior to December 20.

In conclusion, adverse winter weather is associated with thousands of vehicle crashes, injuries, and fatalities each year in the United States. Nonetheless, little is known about how meteorological forecasts, meteorological conditions, and non-meteorological conditions combine to influence driving decisions. The December 20–21, 2006, winter storm along the Colorado Front Range provided an opportunity to advance our knowledge on decision making with respect to driving in severe winter storm conditions. Results from this study also provide a roadmap for additional studies, which ultimately should improve our understanding of the public's sources, uses, and perception of weather forecast information, as well as how forecasts, observed weather, and non-meteorological conditions combine to influence people's actions during hazardous weather events.

ACKNOWLEDGMENTS

This research was funded by a Quick Response Research grant from the Natural Hazards Research and Applications Information Center, University of Colorado, Boulder, Colorado. Special thanks to

Julie Demuth for comments on the manuscript. Thanks to Larry Mooney (NWS) for providing archived NWS forecasts and other data related to the December 20–21, 2006, winter storm. Thanks also to Matt Kelsch for providing an overview of the meteorological conditions during the winter storm. Finally, thanks to Julie Demuth, Eve Gruntfest, Jeff Lazo, Rebecca Morss, and the WAS*IS program; this would not have been possible without WAS*IS.

REFERENCES

1. Andrey, J., and C. Knapper. Motorists' Perceptions of and Responses to Weather Hazards. In *Weather and Transportation in Canada* (J. Andrey and C. Knapper, eds.). Department of Geography Publications Series Number 55, University of Waterloo, 2003.
2. Andrey, J., B. Mills, M. Leahy, and J. Suggett. Weather as a Chronic Hazard for Road Transportation in Canadian Cities. *Natural Hazards*, Vol. 28, 2003, pp. 319–343.
3. Federal Highway Administration. *Road Weather Snow and Ice Statistics*. www.ops.fhwa.dot.gov/weather/weather_events/snow_ice.htm. Accessed June 2, 2007.
4. National Oceanic and Atmospheric Administration. Weather Fatality Statistics. www.weather.gov/os/hazstats.shtml#. Accessed June 2, 2007.
5. National Research Council. *Where the Weather Meets the Road: A Research Agenda for Improving Road Weather Services*. National Academies Press, Washington, D.C., 2003.
6. Andrey, J., B. Mills, and J. Vandermolen. *Weather Information and Road Safety*. Institute for Catastrophic Loss Paper 15, 2001.
7. Kilpeläinen, M., and H. Summala. Effects of Weather and Weather Forecasts on Driver Behaviour. *Transportation Research Part F*, Vol. 10, 2007, pp. 288–299. DOI 10.1016/j.trf.2006.11.002.
8. Couper, M. C. Web surveys: A Review of Issues and Approaches. *Public Opinion Quarterly*, Vol. 64, 2000, pp. 464–494.
9. National Oceanic and Atmospheric Administration. *Service Assessment: Oklahoma/Southern Kansas Tornado Outbreak of May 3, 1999*. NOAA, 1999.
10. NRC. *Fair Weather: Effective Partnerships in Weather and Climate Services*. National Academies Press, Washington, DC., 2006, 238 p.
11. Hill, J.D., and L. Ng Boyle. Driver Stress as Influenced by Driving Maneuvers and Roadway Conditions. *Transportation Research Part F*, Vol. 10, 2007, pp. 177–186. DOI 10.1016/j.trf.2006.09.002.
12. Drobot, S. D., C. Benight, and E. C. Gruntfest. Risk Factors Associated with Driving Through Flooded Roads. *Environmental Hazards*, Vol. 7, 2007, pp. 227–234, DOI 10.1016/j.envhaz.2007.07.003.
13. Bandura, A. 1988. Self-Efficacy Conception of Anxiety. *Anxiety Research*, Vol. 1, pp. 77–98.

Winter Events, Fog, and Performance Measures

WINTER EVENTS, FOG, AND PERFORMANCE MEASURES

The Role of Risk, Reliability, and Probability in the Interaction of Weather and Surface Transportation

WILFRID A. NIXON
University of Iowa

It is clear that weather can have a profound, negative impact upon surface transportation (see, for example, *Where the Weather Meets the Road*, National Research Council, 2004). The challenge is what actions can be taken to mitigate these negative impacts. This challenge is further complicated because actions, to be as effective as possible, must be set in motion prior to the weather event that will create the negative impacts. In short, the actions must be proactive and must thus be based upon a weather forecast. It is in the nature of weather forecasts that they are not always correct. Indeed, a trend in weather forecasts is to express the forecast in terms of a percentage of probability. Thus, a forecast may indicate that there is a 70% chance of rain occurring in a given area during a given time period. This creates both an opportunity and a challenge for any operational response to a forecast that is designed to mitigate negative impacts. The challenge lies in determining the percentage probability at which action should be triggered. The opportunity lies in the ability to use the percentage probability in a model designed to weigh the costs and benefits of certain possible actions, and compare those costs and benefits to the costs and benefits of other actions, or of the specific action of doing nothing in response to the forecast. Probability has long played a role in certain aspects of civil engineering related to the weather. For example, many bridges are constructed on the basis of a 100-year flood (which is a flood that has a 1% chance of occurring each year). However, these uses of probability have typically been related to design of infrastructure, rather than to the operation of an infrastructural system such as a transportation network. This presentation will explore methods to incorporate the probability of certain weather events into the decision-making process that guides operational actions based upon weather forecasts. The methods considered use a cost-benefit approach, and in essence calculate the cost of doing nothing in response to a given weather event, compare that to the cost of taking action so as to mitigate the impact of that given weather event, and create a probability distribution of costs and benefits for a given event. In essence, this probability distribution will suggest that when the likelihood of a certain event is greater than a certain probability, then preventative actions should be taken. In addition to discussing the results of this model, the drawbacks of this sort of approach will also be discussed.

WINTER EVENTS, FOG, AND PERFORMANCE MEASURES

Fog Forecast Provision Experiment for a Mountain Pass**YUMA MATSUYAMA****TATSUO MIYOSHI****MATSUDA YASUAKI****MASARU MATSUZAWA****YASUHIKO KAJIYA***Civil Engineering Research Institute for Cold Region, Japan*

Roads in Hokkaido, the northernmost island of Japan, suffer poor visibility from snowfall, snowstorm and dense fog. Fog often occurs at mountain passes separating the Pacific Coast of Hokkaido from inland areas. Such visibility reduction increases the risk of rear-end collisions, because leading vehicles are recognized later than in clear weather. To support trip planning, it is important to provide drivers with fog forecasts in addition to conventional winter road weather information. We provided fog forecasts via Internet on a trial basis for Nissho Pass on National Highway 274, where fog occurs in every season. Fog was forecast using a statistical model based on analyses of weather and fog data for the past three years. We found that fog tends to occur when the humidity is high and weak winds blow from cardinal points ranging from east to south and that the most influential weather factors in fog occurrence are wind speed, wind direction, and humidity. Based on these three factors, we categorized weather conditions into six combinations. We divided the road section that includes Nissho Pass into six subsections. The fog percentage (hours of fog/hours of that weather condition \times 100) for each of the six combinations of weather conditions on each of the six road sub-sections was calculated from meteorological records. This percentage is regarded as the probability of fog occurrence, and the probabilities were classified into the four ranges of 0%–10%, 10%–40%, 40%–70%, and 70%–100%. Our model output a current fog forecast and a forecast for each of the next 6 h as one of the four fog probability ranges, and these were provided by web page in July 2006. To determine the forecast accuracy, we analyzed road image data recorded during the same period. A fog percentage was calculated for each of the six combinations of weather conditions on each of the two road subsections of the mountain pass by visually judging image data for fog. Each observed fog percentage fell within the probability range of the fog forecast. Finally, to evaluate the usefulness of the fog forecast web page, we surveyed website visitors by online questionnaire. Eighty percent of the respondents responded that they thought fog forecasts were useful, attesting to their high acceptance of the system.

The driving environment on roads in Hokkaido, Japan, changes greatly depending on season and weather conditions. Reduced visibility often occurs. In winter, it results from snowfall and snowstorm, and in the snow-free season, summer in particular, it results from the dense fog that occurs mainly at mountain passes inland from the Pacific. The reduced visibility poses an increased psychological burden on driving in general; more specifically, drivers worry that it prevents them from having enough time to avoid accidents (1). Measures against reduced visibility at mountain passes are important. Road administrators are improving road alignments, installing and improving climbing lanes, implementing snow control measures, installing delineation facilities, improving road maintenance, and providing images of road conditions. In addition, it is important to support safe driving by providing drivers with detailed information before their departure (2, 3).

The Civil Engineering Research Institute for Cold Region and the Obihiro Development and Construction Department of the Hokkaido Regional Development Bureau, Ministry of Land, Infrastructure and Transport, conducted an experiment on fog information provision through the Internet to support drivers in making driving schedules. The mountain pass for the experiment was Nissho Pass on National Highway 274.

This paper reports on the information provision experiment, including a 2006 evaluation of that provision.

NISSHO PASS AND THE IMPORTANCE OF FOG INFORMATION PROVISION

National Highway 274 connects Central Hokkaido, whose core city is Sapporo, the Tokachi area, whose central city is Obihiro, and the Kushiro–Nemuro area, whose central city is Kushiro. The highway is an important artery for exchanges of people and goods in a wide area. It is also important for tourism in Hokkaido. Nissho Pass (elev. 1,022 m) on this route is on the border between the towns of Hidaka and Shimizu (Figure 1). Driving conditions in Hokkaido are generally severe, and at this pass, which traverses the northern part of the Hidaka Mountains, driving conditions are particularly severe. Fog occurs at the pass throughout the year. In summer, cold, moist air frequently blows in from the Pacific Ocean, causing dense fog to form, mainly on the Shimizu side, and reducing visibility. In winter, when low-pressure systems pass over the area or northwesterly seasonal winds blow, reduced visibility is frequently caused by snowfall and blowing snow.

To obtain data on dense fog at Nissho Pass, we examined the road patrol records for the 10 years from FY1994 and totaled the number of days when the visibility distance was <200 m. The following is the result of our findings:

- Fog occurrence concentrates on the Shimizu side of the pass. Even when it is sunny on the Hidaka side, fog often occurs on the Shimizu side (Figure 2). The pass is divided, according to Japanese custom, into 10 stages, each representing a 10% increase in elevation; i.e., the fifth stage represents the halfway point between the base and the top of the pass. Fog is particularly frequent at the fifth stage on the Shimizu side.
- In July and August, visibility was reduced to <200 m or less on 1 of 3 days, and on half of those days of reduced visibility, the visibility distance was <50 m.
- Fog tended to occur between sunset and sunrise. It usually dissipated by noon, when the air temperature tends to rise.

Fog occurs throughout the year at Nissho Pass, and it is particularly frequent in summer. Under visibility reduced by dense fog, the risk of crashing into a leading car or of being rear-ended by a trailing car increases, and the psychological burden on the driver increases. It is important for the road administrators to support safe driving by providing advance fog and visibility information.



FIGURE 1 Nissho Pass.



FIGURE 2 Simultaneous road images at two locations (15:00, August 12, 2005).

EXPERIMENT

We developed a method for estimating fog occurrence, and we constructed a system to provide fog information (real-time and forecast). Using the system, we provided fog information for Nissho Pass (from the first stage on the Hidaka side to the first stage on the Shimizu side) by Internet from July 3 to October 3, 2006. After the experiment, we evaluated the provided forecast information in terms of accuracy, and we surveyed users by questionnaire for their opinions on the information.

Fog Forecasting Based on Statistical Estimation

To develop a fog forecast method that is based on statistical analysis, we took the following steps by using previous data on fog occurrence and other weather conditions:

1. By using the fog occurrence data (April to September) recorded by road patrol units for Nissho Pass during the three years from 2002, we clarified the conditions under which fog tends to occur and we chose a road section for our experiment.
2. By examining the weather conditions that may be associated with fog occurrence, we determined the weather conditions that correlate with fog occurrence.
3. We collected grid point value (GPV) data [a grid point datum of various weather elements, created and used for weather forecasting by the Japan Meteorological Agency (JMA)] for each of six elevations (atmospheric surfaces) of the JMA's numerical mesoscale model (MSM) (5-km grid), and extracted the point data that are close in location and elevation to the subject locations. The determined weather elements (wind direction, wind speed, humidity) were sorted into six combinations (Figure 3). For each of the six weather combinations, the fog occurrence probability (%) was estimated based on the weather data and on the fog data collected by road patrols during the three years from 2003. The fog data were sorted into "fog with visibility distance <200 m" and "no fog." A fog occurrence probability is estimated for three elevations (the first, sixth, and ninth stages) on the Hidaka and Shimizu sides of the pass. The table at the bottom of Figure 3 shows the probabilities.
4. The categories representing combinations of weather conditions and fog occurrence probabilities were determined through the above procedures. The experimental forecasting method we developed for Nissho Pass has six weather combinations and four fog occurrence probabilities (0%–10%, 10%–40%, 40%–70%, and 70%–100%).

The threshold for designating fog occurrence was based on previous studies on snowstorm-induced visibility reduction (4). Dense fog was defined as fog that reduced the visibility distance to <200 m. Previous studies on snowstorm and reduced visibility determined visibility distances of <200 m as problematic. The standard for issuing a dense fog advisory in Hokkaido is visibility <200 m.

Fog Information Provision System

Using the developed estimation method, we constructed a system for providing fog forecast.

As shown in Figure 3, the GPV data (wind direction, wind speed, relative humidity) of the MSM were obtained from the JMA. The data for the grid that corresponds to each pass location are extracted for each elevation (first, sixth, and ninth stages on both sides) for collation.

The fog occurrence probability is determined as one of four ranks based on the six combinations of weather conditions. The determined probability is provided as fog forecast information on the Internet.

The GPV data of the MSM are updated eight times a day, every three hours. The GPV data include the current and forecast values. We updated the information every three hours.

The forecast information was provided hourly for the 6 h ahead, which is long enough for drivers starting at any of the three major cities served by the route (Obihiro, Kushiro, Sapporo) to alter a driving itinerary that includes Nissho Pass.

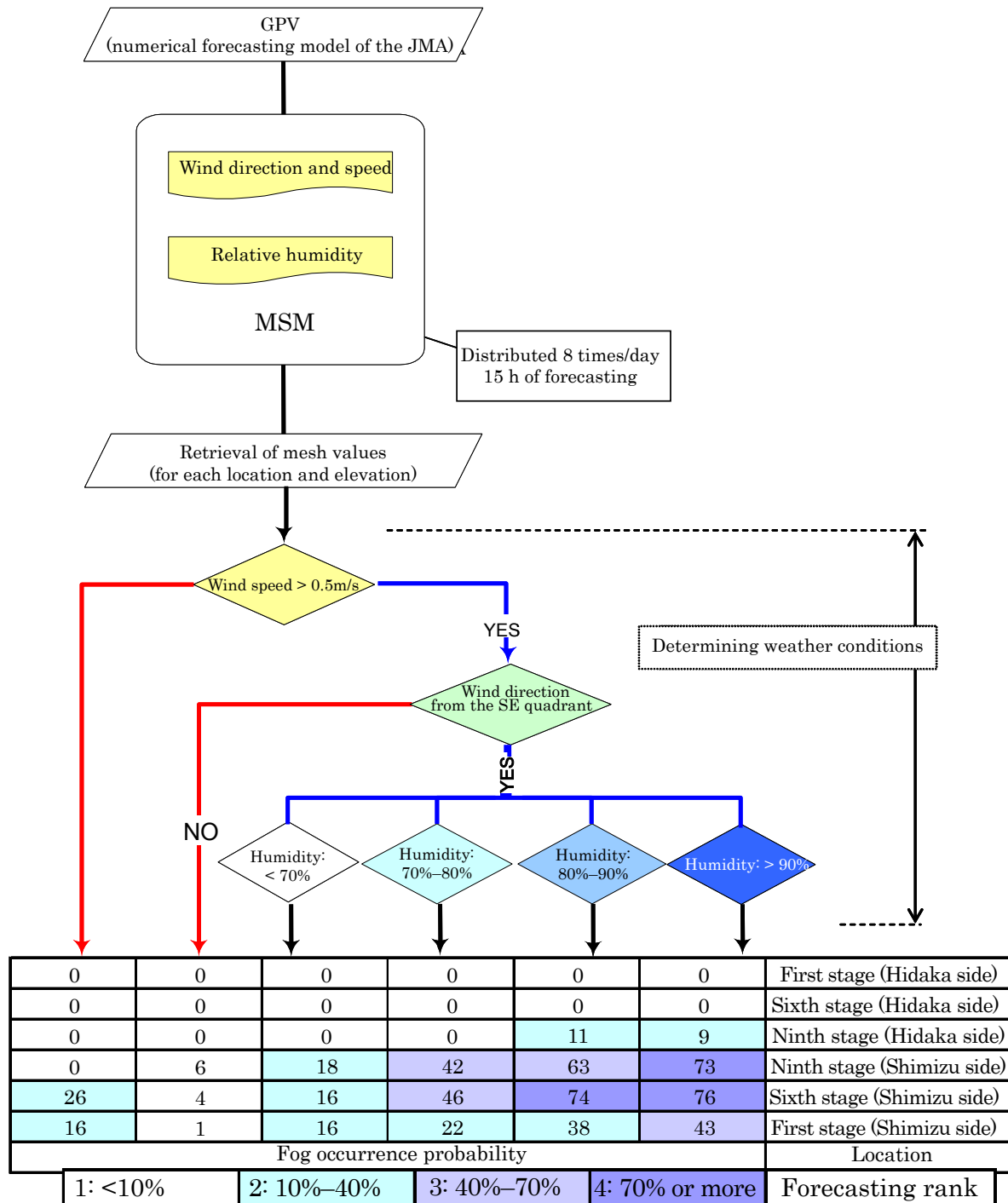

FIGURE 3 Forecasting fog occurrence based on statistical estimation. Figures in the table show the fog occurrence frequencies (%) for 3 previous years, divided into six categories according to the weather conditions.

Interface

1. Fog conditions (current at Nissho Pass): The current probability of fog occurrence is indicated by one of four ranks on a color scale of purple. The road section is divided into six sub-sections: base, middle, and top of the Hidaka and Shimizu sides of the pass (Figure 4). Road images and telemeter data are also shown.
2. Six-hour hourly fog forecast at Nissho Pass: Fog forecasts for the current time and hourly for the 6 h ahead are provided (Figure 5).

The forecast is shown on a profile of the pass that makes it visually easy to understand (5).

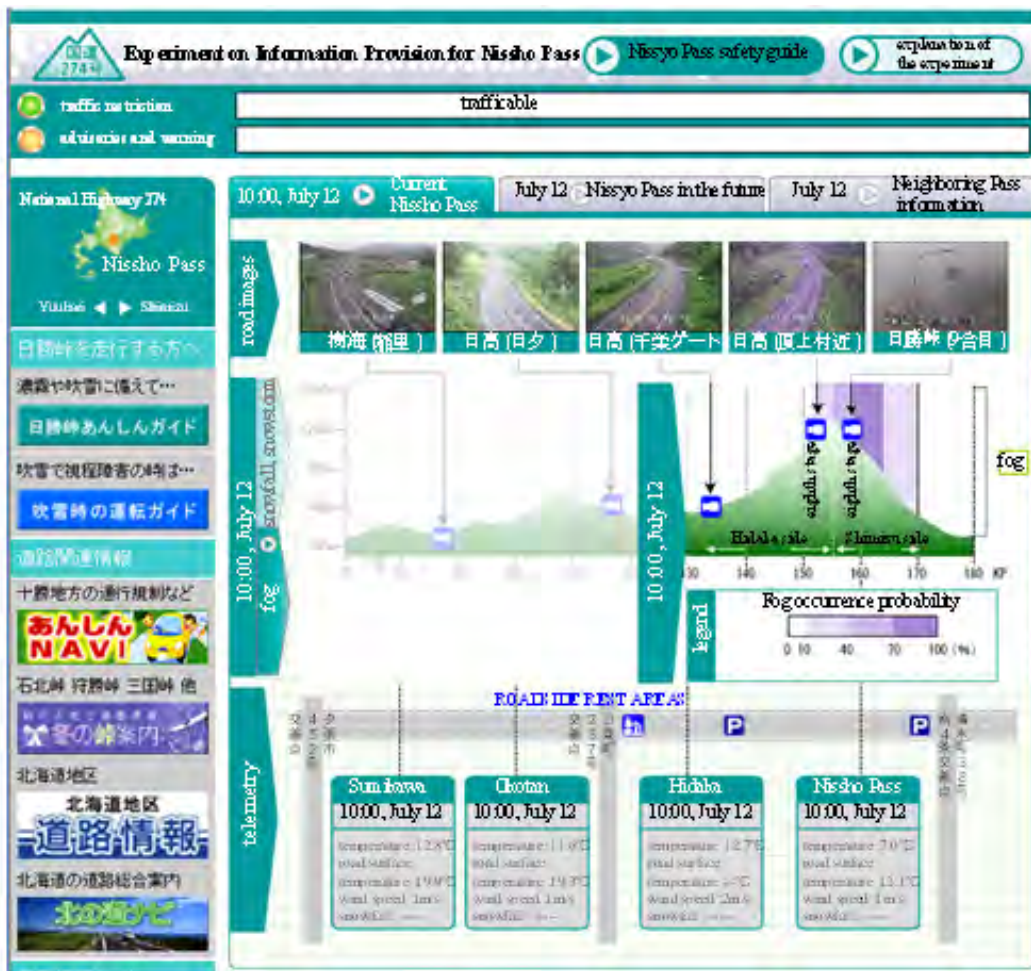

FIGURE 4 Homepage for provision of information on Nissho Pass.

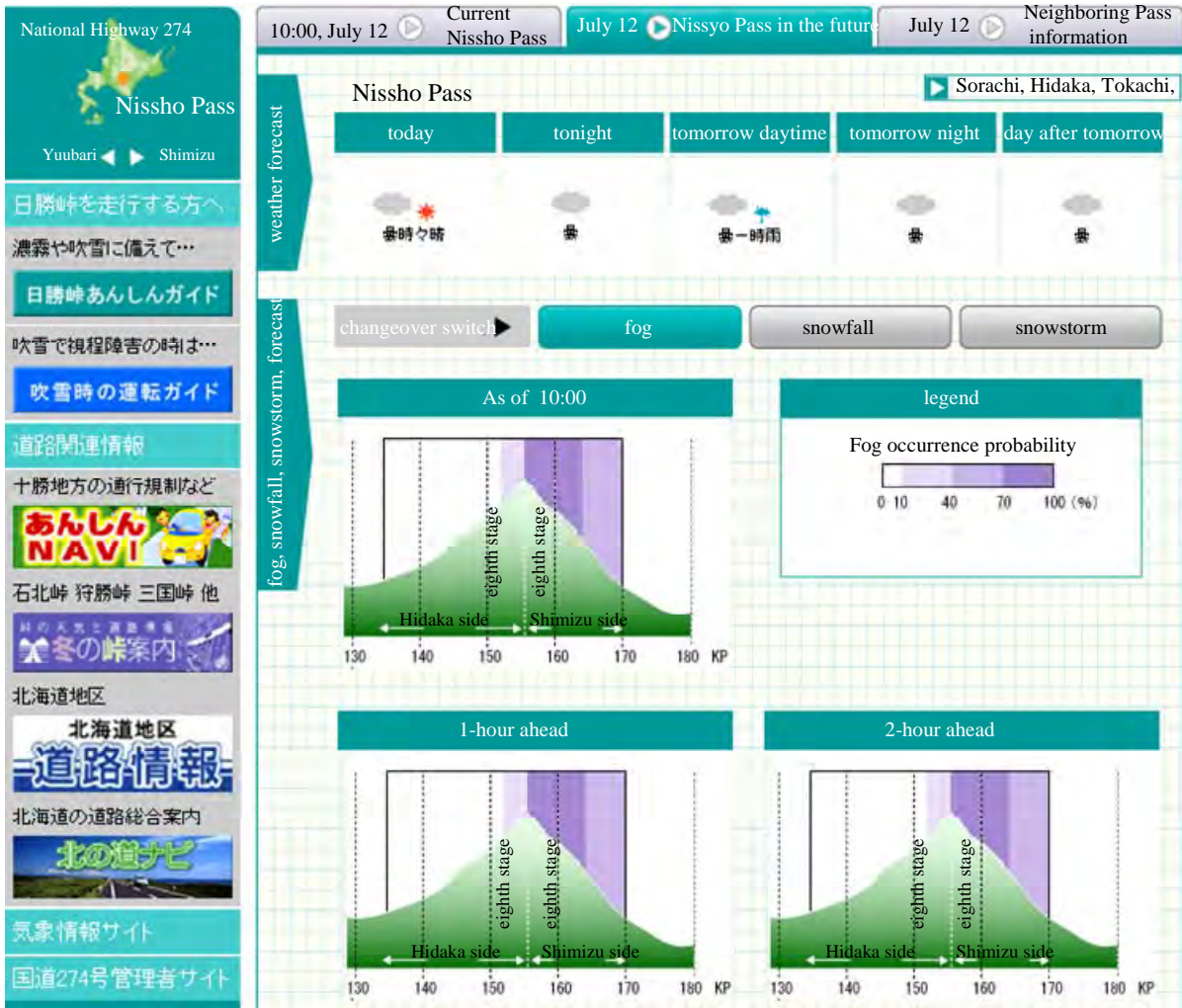

FIGURE 5 New homepage for provision of forecast information on Nissho Pass.

RESULTS OF THE EXPERIMENT

Accuracy of the Fog Forecasts

To determine the accuracy of the fog forecast information provided, we compared the forecast information with actual fog occurrence.

The actual fog occurrence was determined from hourly CCTV images taken at the ninth stages on the Hidaka and Shimizu sides of the pass, which are available on the Internet. Fog determination was done by visual observation, and visibility distances < 200 m were defined as “fog.” Absence of fog or localized fog was defined as “no fog.”

The evaluation period was June 27 to October 31, which includes the days of the experiment. The evaluation method is shown in Table 1. The fog occurrence rate (p) (Table 1) was obtained for each of the four ranges of fog occurrence probability, and p was compared with the range of fog occurrence probability. When the fog occurrence rate (p) fell within the respective range of fog occurrence probability, we regarded the forecast as accurate. The results

of this evaluation are shown in [Figure 6](#).

The figure shows that for the ninth stage on the Hidaka side, the fog occurrence rates (p) of up to 10% and 10%–40% fall within the respective ranges of fog occurrence probabilities. Fog occurrence is not often observed at the ninth stage of the Hidaka side, so fog occurrence rates are available only for the lower two ranges of fog occurrence probability.

For the ninth stage on the Shimizu side, the fog occurrence rates (p) fall within the respective ranges of fog occurrence probability, although for the rate of 10%–40%, the fog occurrence rate (p) is 9%, which is slightly below the corresponding range.

For Nissho Pass, the actual fog occurrences roughly fell within each of four respective ranks of fog occurrence probability that were determined using our statistical fog forecasting method. It was verified that our forecast method provides accurate fog forecasts.

Questionnaire Survey

A questionnaire survey was carried out to evaluate the experimental website and its content in terms of usefulness, problems, and user acceptability. The survey period was July 14 to October 20, 2006. The attributes of the respondents and other basic data in the survey are shown in [Table 2](#).

Experience of Driving in Dense Fog, and Fear of Traffic Accidents

[Figure 7](#) breaks down the responses to the following questions: Have you ever driven over Nissho Pass in dense fog? Those who answered yes were asked, At that time, how worried were you about having an accident? Ninety percent of all respondents reported having driven over Nissho Pass in dense fog, and 87% of that 90% reported having been worried about traffic accidents. This can be interpreted as indicating that many drivers experience psychological burden driving under reduced visibility conditions.

Usefulness of the Fog Information

[Figure 8](#) breaks down the responses to several questions on the usefulness of various items of information provided on the website.

TABLE 1 Verification of Fog Forecast

Image \ Estimation	Fog Occurrence Probability			
	<10%	10%–40%	40%–70%	70% or more
Fog	Y_1	Y_2	Y_3	Y_4
No fog	N_1	N_2	N_3	N_4
Fog occurrence rate (p)	$Y_1/(Y_1+N_1) \times 100$	$Y_2/(Y_2+N_2) \times 100$	$Y_3/(Y_3+N_3) \times 100$	$Y_4/(Y_4+N_4) \times 100$

Decision: Calculate Y_n and N_n (unit: hour) based on the image; when the fog occurrence rate (p) falls within the range of fog occurrence probability, the forecast is judged as satisfactory.

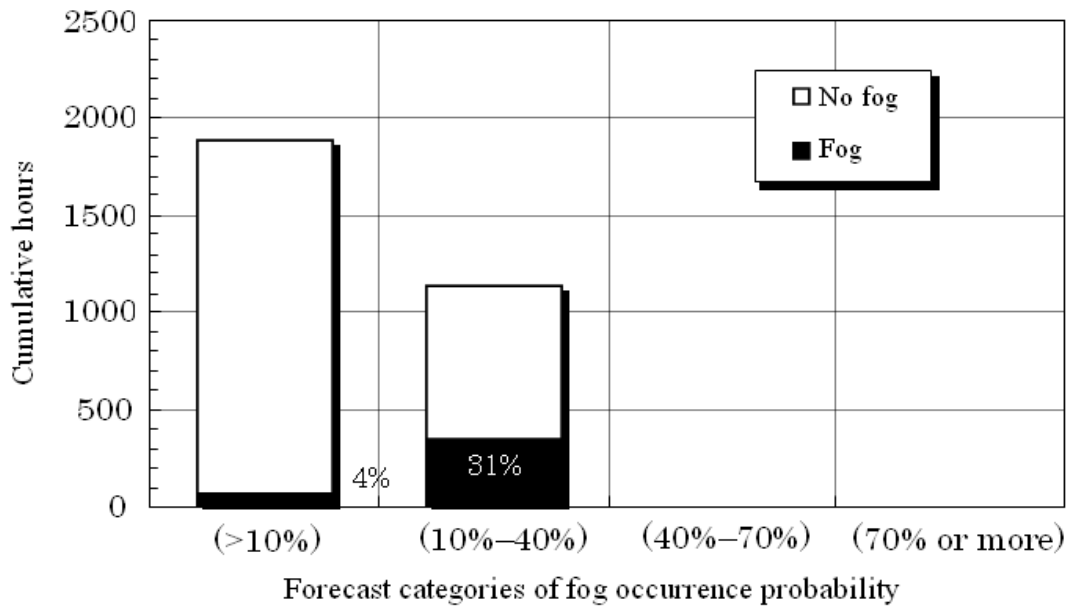

(a)

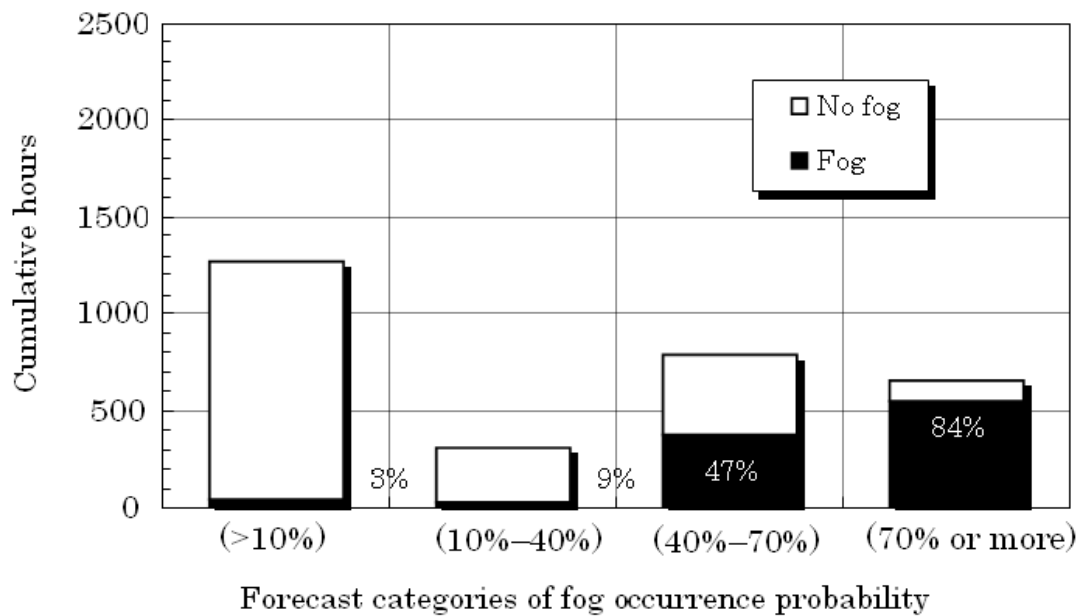

(b)

FIGURE 6 Evaluation of fog occurrence forecast using CCTV images:
 (a) ninth stage, Hidaka side, and (b) ninth stage, Shimizu side.

TABLE 2 Questionnaire Outline and Respondent Attributes

Survey Method	Questionnaire on the Website of the Experiment
Duration of survey	July 14 to October 20, 2007 (99 days)
Number of questions	16
Number of valid responses	210
Sex	Male: 82%; Female: 18%
Age	10s: 1%; 20s: 22%; 30s: 33%; 40s: 30%; 50s: 12%; 60s: 1%; 70s or over: 1%
District of residence	76% live in Ishikari (41%) or Tokachi (35%) subprefecture
Purpose of travel	Most common responses: tourism and leisure (together accounting for 42%); business, visiting hometown, commuting (together accounting for 54%)
Frequency of driving in summer (June to October)	The largest proportion 40%: 1–4 times; 26%: 5–9 times; 26%: 10 times or more,

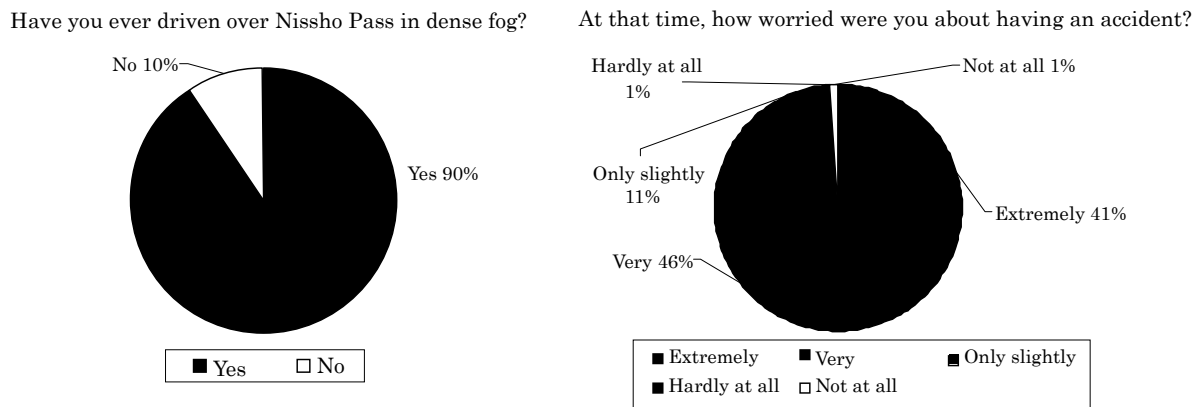

FIGURE 7 Experience of driving in dense fog; fear of accidents.

To the question How useful was the information on current fog conditions? over 80% of respondents answered extremely useful or very useful. Fog information had the second-highest percentage of extremely useful or very useful responses. [The highest percentage of extremely useful or very useful responses (90%) was to the question How useful was the information on road images?] To the question How useful was the information on fog forecast? about 80% of respondents answered extremely useful or very useful. The responses regarding current fog information and fog forecast suggest that the provision of information on fog at passes is useful to drivers.

The above-mentioned respondents were those who reported having experienced psychological burden from driving in dense fog. It can be interpreted that provision of fog information will improve driving comfort and reduce psychological burden.

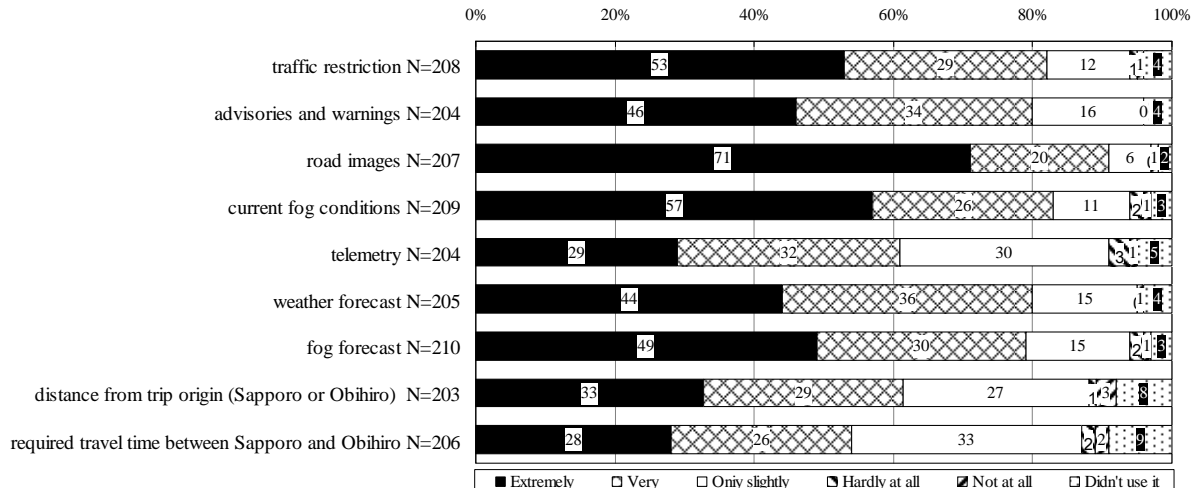

FIGURE 8 How useful was the information on...?

Changes Prompted by Information Provision

Drivers were asked, Did the information prompt you to consider changing your travel plans? Figure 9 breaks down the answers: 35% answered no even though the weather was bad; 37% answered either yes, although I didn't end up making changes; or yes and I ended up making changes.

Previous studies on provision of information on snowstorms (6) reported that of the drivers who reported changing their travel plans as a result of receiving information, the most common change was departure time and the next most common change was travel route. This study during the snow-free season and previous studies during the snowy season suggest that information provision can prompt positive changes in travel behavior, which in turn suggests that such provision can help to reduce traffic accidents and psychological burden on the driver. Information that broadens the travel options of drivers is necessary to improve the system.

SUMMARY

Summary of the Experiment

The following are the results of our information provision experiment:

- We confirmed that actual fog occurrence rates fell within the respective ranges of the fog occurrence probabilities (0%–10%, 10%–40%, 40%–70%, and 70%–100%) determined using our statistical fog forecasting method. We were able to provide useful fog forecast information through the system.
- About 80% of drivers who responded to the questionnaire answered that the real-time and forecast fog information was extremely useful or very useful. This demonstrates the potential usefulness of providing fog information for this pass section.

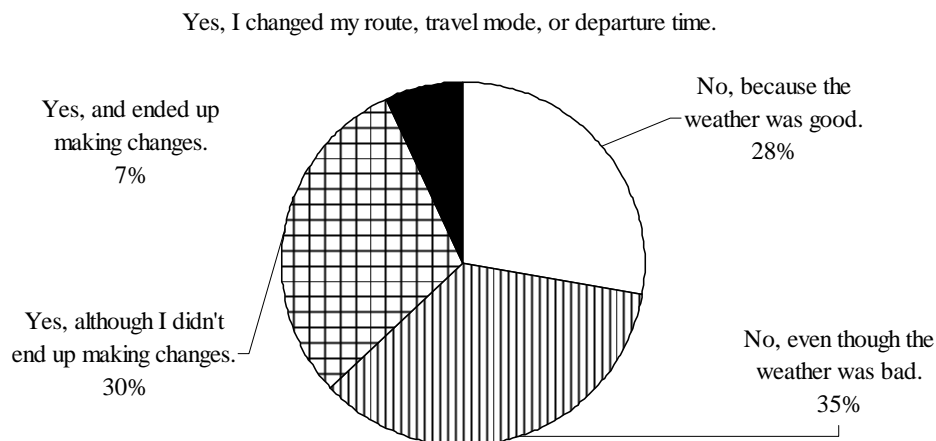

FIGURE 9 Did the information prompt you to consider changing your travel plans?

Future Issues

We think it necessary to improve the accuracy of the fog forecast and to review the division of probability ranges of the present system. We will continue to operate the website and to accumulate data toward improvements in identifying weather conditions associated with fog occurrence.

This study targeted drivers who were preparing for a trip and who were able to use a personal computer to collect information for trip planning. Information access was limited to that before departure; no access was possible en route. We think it is necessary to provide information that can be collected through car navigation systems or mobile phones while en route.

To use this system for other pass sections it is necessary to tailor the statistical forecasting method to each pass, because each pass section has individual topographic characteristics that give it a distinctive fog occurrence process. This study shows that it is possible to develop a fog information provision system similar to the one we developed in this study by clarifying the relationship between fog occurrence conditions in three previous years and the GPV data published by the JMA.

CONCLUSION

The effectiveness of fog information provision at Nissho Pass was verified, and the Experiment on Information Provision for Nissho Pass on National Highway 274 has been under way by the Obihiro Development and Construction Department of the Hokkaido Regional Development Bureau, Ministry of Land, Infrastructure and Transport since April 2007. We expect to improve the system toward making it more useful in supporting driving safety.

We wish to conclude by expressing our gratitude to those who cooperated in the questionnaire survey and to the Obihiro Development and Construction Department of the Hokkaido Regional Development Bureau, Ministry of Land, Infrastructure and Transport, for its support in developing our system and conducting the experiment.

REFERENCES

1. Suzuki, T., Y. Kajiya, and M. Matsuzawa. *Advanced Information Provision System for Winter Roads: Effectiveness of a Wide-Area Information Provision Service*. Monthly report. Hokkaido Civil Engineering Research Institute, No. 616, September 2003.
2. Kajiya, Y., T. Uemura, and Y. Yamagiwa. User Needs for and Effectiveness of Road Information Provision through the Internet: User Questionnaire Survey and Customer Satisfaction Analysis of "Kita-no-Michi." *Proc., Cold Regions Technology Conference*, Vol. 19, November 2003.
3. Chiba, T., Y. Kajiya, and Y. Kumazawa. *Road Information Provision Using the Internet: Report on an Experiment to Transmit Images of a Road over a Pass in Winter '96/'97*. Monthly report. Hokkaido Civil Engineering Research Institute, No. 534, November 1997.
4. Kajiya, Y., M. Matsuzawa, T. Suzuki, K. Tanji, and Y. Nagata. Driving Behaviors under Reduced Visibility Conditions in Snowfall and/or Blowing Snow. *Proc., Cold Regions Technology Conference*, Vol. 20, October 2004.
5. Kajiya, Y., Y. Yamagiwa, N. Kuramoto, and H. Masaoka. Needs Analysis and Creation of a Brand through Operation of the Kita-no-Michi Website. Presented at 4th ITS Symposium 2005, December 2005.
6. Matsuzawa, M., Y. Kajiya, T. Miyoshi, and Y. Yamagiwa. *Basic Study for the Advanced Information Provision System for Winter Roads: A Field Experiment for Wide-Area Road Information Provision Services*. Monthly Report, Civil Engineering Research Institute for Cold Region, No. 645, February 2007.

WINTER EVENTS, FOG, AND PERFORMANCE MEASURES

Performance Measures for Snow and Ice Control Operations**THOMAS H. MAZE****CHRIS ALBRECHT****DENNIS A. KROEGER***Iowa State University*

Under the NCHRP 06-17 project, the research team surveyed snow and ice control organizations in the United States, Canada, Europe, and Asia to determine the current trends in performance measurement. The team also inquired about the methods used in developing these programs in order to determine a practical, user-friendly method to assist snow and ice control managers in developing a performance measurement system that uses traditional and nontraditional performance indicators and measurement issues. To achieve the project objectives, the researchers issued a survey to snow and ice control agencies throughout North America, Europe, and Asia to obtain data on the performance indicators and measures used, if any, by these agencies. The identified performance indicators and measures were then categorized, defined, and assessed for their usefulness. A process was then developed to assist snow and ice control operations managers in preparing a customer focused, environment-friendly performance measurement program.

The issue of performance measurement for snow and ice control has been a topic of much interest. Developing meaningful data for snow and ice control has produced a variety of responses and differing goals and objectives. However, a rigorous process that the snow and ice control industry can use to determine the most appropriate performance measures and indicators has been lacking.

Research was needed to examine current trends and issues and develop a process that can be used by snow and ice control agencies to prepare a performance measurement system that is sensitive to organizational and public needs as well as environmental concerns.

The research would also analyze the different dimensions along which an agency's performance could be defined, measured, and interpreted based on an agency's goals and objectives.

Under the NCHRP 6-17 project, the research team surveyed snow and ice control organizations in the United States, Canada, Europe, and Asia, to determine the current trends in performance measurement. The team also inquired about the methods used in developing these programs in order to determine a practical, user-friendly method to assist snow and ice control managers in developing a performance measurement system that uses traditional and nontraditional performance indicators and measures issues. The plan provides a list of options of performance indicators and measures, and explains how to incorporate the indicators and measures in the decision-making process to monitor and improve snow and ice control operations.

To achieve the project objectives, the researchers first reviewed pertinent literature and research findings in the area of performance measurement systems. Next, a survey was issued to snow and ice control agencies throughout North America, Asia, and Europe to obtain data on the

performance indicators and measures used, if any, by these agencies. These performance indicators and measures were then categorized by functional type and were fully defined. An assessment of the usefulness of each was prepared. The research team then summarized the theory and practice of the performance measurement. The performance measures were then identified by their key aspects and identifying performance indicators and measures that may have applicability in snow and ice control operations. A process was then developed to assist snow and ice control operations managers in preparing a customer-focused, environment-friendly performance measurement program.

The purpose of this research is to provide a synthesis of measures used throughout the world to evaluate the performance of winter maintenance activities (snow and ice removal from roadways) and to make recommendations for further development of the most promising measures. The research was conducted in two parts. The first part entailed a comprehensive review of performance measures that have been and are currently being used by transportation agencies around the world. This was done through a thorough review of the literature and a survey of dozens of agencies with winter maintenance responsibilities. In the second part, the list of performance measures was narrowed to a few that offered the most promise. In other words, these were measures with the most potential to be applied economically to a roadway network and provide reliable, repeatable, and comparable measures of performance. These most promising measures were then recommended for further development.

PERFORMANCE MEASUREMENT

For many transportation agencies, performance measurement has become a critical issue in the last 5 to 10 years, and several significant contributions to the literature have been made on the fundamentals of how transportation agencies should tie strategic direction and agency mission to performance measures.

Performance measurement is one component of a larger “quality in government services” movement. The growing emphasis on performance measurement by transportation agencies has not been addressed sufficiently because there wasn’t a need to measure performance in the past, but also due to two forces:

1. A culture at transportation agencies that has historically focused on standards and specification for physical conditions or level of service (LOS). Generally, transportation agencies have defined the LOS or conditions of a facility based on static standards.
2. The vast expansion of information technology and the ability to collect information that would have been too costly or impossible to collect in the past has made the collection of performance-related data possible.

Measurement of Winter Maintenance Performance

Although winter maintenance is a critical activity, there are no standard methods for measuring performance for either agency programs or programs led by contractors. The lack of standard measures makes it difficult to manage and control winter maintenance activities and subsequently impossible to benchmark and make comparisons both between and within

maintenance programs. Measuring the performance of winter maintenance makes it possible to make intelligent management trade-offs between agency costs and user costs.

Agencies that currently measure winter maintenance performance do so from one or more of three basic perspectives:

- **Inputs.** Input measures represent the resources spent or utilized to perform snow and ice control operations. These include fuel usage, labor hours, machinery or equipment hours, and units of anti-icing materials or abrasives. The level of inputs is directly proportional to agency costs and, therefore, they most easily and most commonly are measured by transportation agencies. Because inputs are applied at the beginning of the winter maintenance process, they are unable to help management assess the efficiency, quality, and effectiveness of winter maintenance.
- **Outputs.** Outputs quantify the resulting physical accomplishment of work put forth in applying resources in winter maintenance. Outputs might include the lane-miles plowed or sanded, the number of lane-miles to which deicing materials were applied, lane-miles of anti-icing brine applied, and other accomplishments of the maintenance process in units of work. Outputs are generally more useful than inputs alone because inputs and output together can help to define how technically efficient winter maintenance operations are performing. In other words, they can tell the winter maintenance manager what level of input was or will be required to achieve a level of output. These measures may also be based on time and storm event.
- **Outcomes.** Performance measures that seek to measure outcomes take into account the relative effectiveness of the winter maintenance activity, very often from the perspective of the user or customer. Outcomes are inherently more difficult to measure. A desired outcome of winter maintenance might include the improvement of safety, mobility, and user satisfaction. Safety, mobility, and user satisfaction are abstract concepts and, therefore, are measured through indicators that are known to be related to the desired outcome. For example, safety might be measured through pavement friction or through the reduction in number of crashes.

Putting Winter Maintenance Performance Measurement into Context

To make comparisons between and among jurisdictions, differences in the severity of storms must also be taken into account. The severity of a storm impacts the performance of winter maintenance. To illustrate the relationship between inputs, outputs, outcomes, and the environment, a fishbone diagram is shown in [Figure 1](#). The top of the figure shows some of the environmental inputs. On the bottom are labor, equipment, and materials inputs for removing snow and ice from the roadway network. At the arrow, the results of the interaction between the environmental variables and the inputs to snow and ice removal are shown.

In this case, we have identified satisfying the customer (the road users) as our desired outcome, and because shorter time to bare pavement is related to higher levels of satisfaction, time to bare pavement is the resulting performance measure. The measurement of time to bare pavement must be supported by a specific data collection methodology.

Summary of Synthesis Findings and Assessment

Various instances of research and testing of proposed performance measures were described in the literature, but often without implementation or field testing. It appeared that a handful of

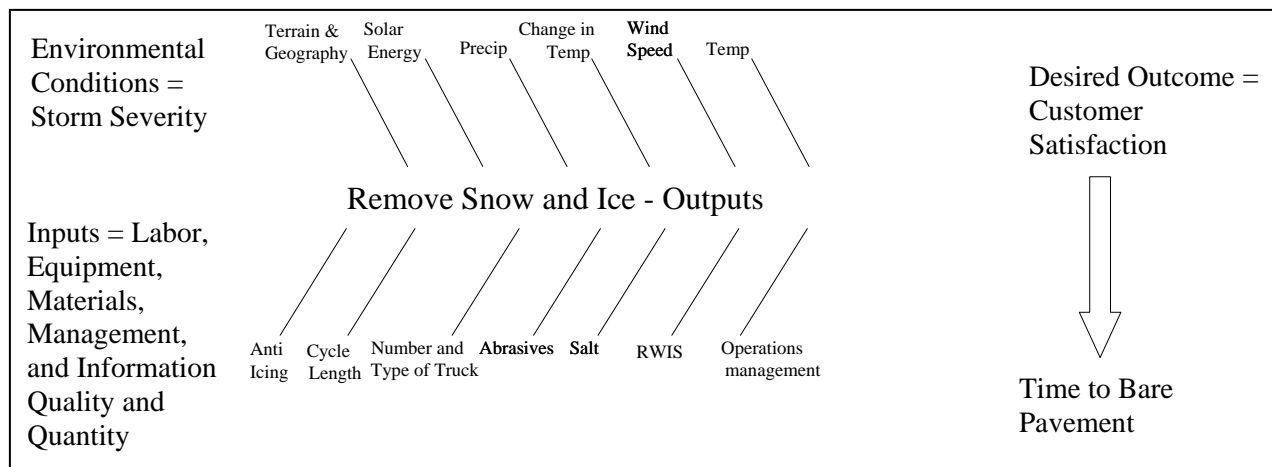

FIGURE 1 Relationship between inputs, outputs, and outcomes.

European countries and Japan are more progressive in terms of developing and implementing winter maintenance performance measures, likely because more snow and ice control operations are contracted to private companies internationally than in the United States.

The survey of winter maintenance personnel was sent to 162 agencies covering the U.S. Snow Belt states, Canadian provinces, northern Europe, and Japan. In all, 39 agencies responded to the survey, with responses covering agencies that did no snow and ice control performance measurement to those that incorporated performance measures into their management plans. Most performance measures cited by the respondents are tied to their accounting and management systems. These measures include lane-miles plowed, personnel and overtime hours, tons of material used, amounts of equipment deployed, and cost of operations.

Other measures used by some of the respondents include time to bare pavement, time to return to a reasonably near-normal condition, length of road closures, and customer satisfaction. The majority of the measures critical to the respondents' snow and ice control operations focused on public safety and mobility.

In all, the survey analysis identified 4 input measures, 5 output measures, and 11 outcome measures used by public agencies to measure snow and ice control performance. A complete list of the performance measures identified can be found in the final report. To identify measures and approaches that warrant further study, the criteria in Table 1 were applied to the measures and approaches.

As a result of the assessment, it was determined that outcome measures should be pursued further, because if the measurement of snow and ice control is to have a role in improving safety and mobility, measures of outcome must be pursued. To help determine the measures and approaches to pursue further, the 11 outcome measures observed in this study were reduced to three basic categories. Two approaches are possible for each measure (Table 2).

TABLE 1 Measures and Approaches

Measure Criteria
Does the measure directly measure safety, mobility, or public satisfaction?
Does the measure improve snow and ice control?
Is the measure mapped to roadway segments?
Is the measure reported for garages or districts?
Is the measure sensitive to storm characteristics?
Approach Criteria
Is the approach quantitative?
Is the approach stable across observers?
Is the technology used likely to improve?
Is a major capital or operational investment required?
Can the approach be piggybacked on another system to reduce installation cost?

TABLE 2 Approaches Used per Measure

Measure: Degree of Clear Pavement
Approach: manual observation
Approach: camera-assisted observation
Measure: Traffic Flow
Approach: detectors—speed, volume, and occupancy
Approach: road closure
Measure: Crash Risk
Approach: friction (or slipperiness)
Approach: reported crashes

Summary of Key Points

The literature review revealed that a significant amount of published materials deal with different types of performance measures, both in-use and theoretical. However, there was a limited amount of literature documenting agencies' utilization of performance measures in day-to-day practice. Various instances of research and testing of proposed performance measures were described, but often without implementation or field testing by state or local agencies in the United States. It appeared that a handful of European countries and Japan are more progressive in terms of developing and implementing winter maintenance performance measures, likely because more snow and ice control operations are contracted to private companies internationally than in the United States. From this review, the following was discovered:

- Three scanning review teams of U.S. officials, in 1994, 1998 and 2002, have visited Europe and Japan, focusing on winter maintenance activities and advanced intelligent transportation systems (ITS) technologies.
- Performance measures can be divided into three general categories: input, output, and outcome measures.

- Known input measures include labor hours, equipment hours, various material units, and monies expended.
- Known output measures include cost determined by a unit of accomplishment of work performed (e.g., lane-miles plowed or sanded), material application rates, equipping and calibrating trucks, and route characteristics. These measures may also be based on time and storm event.
- Known outcome measures include bare pavement regain time, friction (skid resistance by coefficient of friction), reduction in crashes, duration and frequency of closures, advanced warning time to customers, and customer satisfaction (indicated by customer satisfaction surveys).
- A pavement snow and ice condition chart, as used by some agencies, assists with uniform pavement condition identification by combining traffic flow characteristics and visual observation.
- Various outcome measures can and often are combined to form an overall LOS rating for a roadway.
- Contracts with private sector operators are often written such that reimbursement is based on a combination of input (pay items) and output or outcome measures (expectations).
- Innovative technologies installed on winter maintenance vehicles that aid in the collection of data applied to performance measures include automated vehicle location (AVL), Global Positioning System (GPS), friction meters, and various sensors of material, equipment, and temperature.
- Winter weather severity indices have been developed to help quantify the relationship between the severity of winter weather events and roadway condition or safety factors.

The study also provided an inventory and discussion of the winter maintenance performance measures used by states, provinces, cities, and counties. There is a broad range of participation in the uses of performance measurement, as stated by those surveyed. The range is from not measuring performance of snow and ice control at all to establishing sophisticated measures of performance of operations. The landscape of performance measurement is wide ranging. While many agencies stated the need for performance measurement, only a handful of these have established a formal performance measurement process for their operations. In these times of budget challenges, the agencies have focused their efforts on achieving the desired results of effective snow and ice control to meet the demands of the traveling public.

Survey Results

For this project, the study team sent out a survey to 162 winter maintenance operations personnel throughout the world. The targeted survey respondents were from local, state, and federal agencies. The respondents were chosen to provide feedback unique to their areas of expertise.

Of the 162 surveys distributed, 41 were returned, for a response rate of 24%. Within these 41, 20 states responded, as well as four Canadian provinces, with one response from Europe, and one from Asia. The remaining respondents included those from cities and counties in the United States and Canada. The surveys were distributed by electronic mail and through the postal service. While this response is not as high as we had hoped it to be, the surveys that were returned provide remarkable insight into the use of performance measures in winter maintenance

operations, particularly in the northern hemisphere regions. The respondents were primarily from the United States and Canada.

The responses to the survey covered both ends of the spectrum, from those that did no performance measurement to those that incorporated performance measures into their management plans. Four agencies responded that they do not use performance measures at all, while 34 responded that performance measures were used in some capacity. One agency did not respond. There were also those that indicated that they would like to improve their methods to measure their performance for snow and ice control but weren't able to obtain the proper data. Clearly there is room for improvement in this area.

Most performance measures cited by the respondents are tied to their accounting and management systems. These measures include lane miles plowed, personnel hours, overtime hours, tons of material used, amount of equipment deployed, and cost of operations. Other measures used by the respondents include time to bare pavement, time to return to a reasonably near-normal condition, LOS, and customer satisfaction. Customer satisfaction was cited by 21 respondents as a performance measure. Additionally, 19 respondents indicated that the public was surveyed periodically, either by the department or in a citywide survey. The surveys showed that the public was generally satisfied with their performance. Two respondents indicated that they measured customer satisfaction based on telephone calls or complaints.

The majority of the measures critical to the respondents' snow and ice control operations focused on public safety and mobility. Obviously, these subjects are central to the role of all transportation agencies, so it makes sense that the performance measures would focus on these subjects. By maintaining mobility and traffic flow, accidents are reduced and public safety is enhanced.

Both the state and local agencies are generally interested in providing the best service to the public. However, budget and staffing constraints make it difficult for agencies to experiment with new methods or technologies. The agencies want to be able to provide these services at the lowest possible costs. Therefore, the performance measures that are established cannot be too time consuming or costly to measure.

Eventually, more winter maintenance agencies will adopt more performance measurement practices. The public will continue to expect clear roads and less harm to the environment from snow ice control operations. Technologies such as AVL, GPS, friction meters, and RWIS, among others, hold the key to obtaining additional data to enhance measuring performance. Expanded use of these technologies will bring down the prices as production and competition increase. Both field personnel and management would have to train to focus more on outcomes when using these more costly technologies.

The objectives selected by each agency can drive performance measurement by creating targets toward which activities can be directed. In addition to objectives, performance measures need to include a short-term result, an improvement strategy, and accountable entities. In addition, success with performance measurement will rely upon the ability to create responsive data systems that generate timely data.

Performance measurement offers a promise of improved management and improved outcomes. It builds on a long history and extensive experience in techniques to strengthen and improve winter maintenance operations. As the winter maintenance community moves toward a future that includes performance measurement, program successes will follow.

SYNTHESIS AND ASSESSMENT

Based on the review of relevant literature and survey of agencies, more than 20 distinct performance measures were identified. For some of the measures, agencies used a variety of approaches to acquire the data to calculate the measures. Within this data set, more than 40 combinations were identified. Our approach was to categorize the various measures as input-, output-, or outcome-based and summarize their frequency of use. These measures are listed in Table 3.

Generally, the data for input and output measures come from the agencies' accounting systems or maintenance logs. There is not much variation in the approach to acquiring these data. For outcome measures, however, it is more difficult to obtain data, since the majority of outcome measures are based on some form of manual observation. However, some developing technologies in the experimental stages can provide innovative solutions to acquiring outcome measure data.

Additionally, any measure used for time-series analysis would benefit from applying a storm severity index. There is no shortage of options in the literature. The various indices were evaluated based on the availability of data to calculate the index and its usefulness in improving understanding of performance or communicating performance to administrators.

To provide direction for this synthesis and assessment, the study team developed criteria for evaluating measures and the associated approaches to acquiring data (Table 3). These criteria were applied to screen out measures or approaches that do not exhibit the following characteristics:

- Related to controllable facets of performance,
- Reliable,
- Understandable,
- Timely,
- Consistent, and
- Sensitive to data collection costs.

Screening of Approaches

The survey analysis identified 4 input measures, 5 output measures, and 11 outcome measures used by public agencies to measure snow and ice control performance. To identify measures and approaches that warrant further study, the following criteria were applied to the measures and approaches.

Measure criteria are as follows:

- Does the measure directly measure safety, mobility, or public satisfaction?
- Does the measure improve snow and ice control?
- Is the measure mapped to roadway segments?
- Is the measure reported for garages or districts?
- Is the measure sensitive to storm characteristics?

TABLE 3 Summary of Snow and Ice Control Performance Measures by Category

Input measures
Fuel usage
Overtime hours
Personnel hours
Percent of salt spreaders calibrated
Output measures
Lane miles plowed
Tons of material used
Amount of equipment deployed
Plow-down miles traveled
Cost per lane mile (efficiency)
Outcome measures
Time to bare pavement
Time to wet pavement
Time to return to a reasonably near-normal winter condition
Time for traffic volume to return to “normal” after the storm
Time to provide one wheel track
Friction
Level of service
Travel speed during storm
Customer satisfaction
Crashes per vehicle mile
Traffic volume during storm

Approach criteria are as follows:

- Is the approach quantitative?
- Is the approach stable across observers?
- Is the technology likely to improve?
- Is a major capital or operational investment required?
- Can the approach be piggybacked on another system to reduce installation cost?

Applying these criteria revealed that input and output measures are valuable management tools because they measure the amount of material, labor, and money consumed, as well as the amount of material applied to roads, lane miles plowed, etc. However, these measures do not directly address the goals of the agencies, which all speak to public safety and maintenance of mobility. As they are, input and output measures help with budgeting and can be used roughly to compare efficiency between garages or districts that experience similar snow and traffic conditions. However, as far as the survey could determine, the measures do not improve snow and ice control, but rather track the investment required to do so. The measures are generally not mapped to roadway segments, although they are often reported by garage or by district. Input and output measures are not observed to be sensitive to storm characteristics, although they could be if an index were applied.

Summary of Approaches

In summary, the study team recommends the following:

- Document best practices for manual observation of pavement conditions. Manual observation will clearly be the dominant approach to acquiring winter condition data for a long time, and best practices should therefore be shared.
- Document the use of traffic control center cameras or remote cameras to aid manual observation inputs to performance measures.
- Strongly pursue detector-based approaches that use traffic speed, volume, or occupancy as means of acquiring data measuring performance. Also pursue institutional issues regarding data use, technological opportunities, and technological barriers.
- Document measures that are or can be based on friction. (Friction measuring technology will not be evaluated.)
- Document best practices and opportunities for recording and analyzing crash data during winter storms for use as a performance measure.
- From the 15 storm severity indices found in the literature, recommend a reasonable procedure for incorporating an index to normalize input, output, and outcome measures.
- Determine best practices in the measurement of customer satisfaction and link those measures to measures of operational performance.

What Performance Measures Do for an Organization

The accounting firm of Price Waterhouse has offered three main reasons for establishing metrics in an organization, listed below. These reasons can also be applied to snow and ice control operations:

1. Measurement clarifies and focuses long-term goals and strategic objectives. Performance measurement involves comparing actual performance against expectations and setting up targets by which progress toward objectives can be measured.
2. Measurement provides performance information to stakeholders. Performance measures are the most effective method for communicating about the success of programs and services. For example, in public education, states and school districts routinely issue “report cards” highlighting test score outcomes and other key indicators of educational performance. These have become centerpieces of attention among not only educators, but many other stakeholders. Snow and ice control agencies can also benefit from “report cards” regarding their performance.
3. Measures encourage delegation rather than “micro-management.” Hierarchical structures and extensive oversight requirements can hinder organizational effectiveness. Performance measures free senior executives for more strategic decision making and collective intervention, while clarifying the responsibilities and authority of managers down the line.

Benefits of Performance Measurement

Performance measurements offer the following benefits to an organization:

1. Performance measurement enhances decision making. The process of developing performance measures allows an agency to determine its mission, set goals for desired results, and identify methods of measuring how well the results are achieved. The data generated through performance measurement can be used to determine program effectiveness, evaluate options for road maintenance, and chart long-term programs and fiscal plans. For upper-level management, performance measures can focus attention on outcomes and can allow for solid evaluation techniques.

2. Performance measurement improves internal accountability. Measuring performance gives decision makers a significant tool to achieve accountability. Employees at all levels are accountable to managers for their performance or that of their crew, and upper-level managers are accountable to departmental executives. This relationship becomes much clearer when outcomes and outputs are measured by a commonly accepted standard. Systems such as “management by objectives” or “pay for performance” can be much more effective when teamed with a high-quality measurement system.

3. Performance measurement supports strategic planning and goal setting. Without the ability to measure performance and progress, the process of developing strategic plans and goals is less meaningful. While there is clearly some benefit to thinking and planning strategically, the evaluation of such plans and goals cannot be objective without measuring performance and achievement. For example, our literature review found that the Wisconsin Department of Transportation in 1996 implemented its MAP, which used performance measures to achieve its performance-based service levels. These performance measures are based on customer-oriented outcomes or the results of highway winter maintenance operations that highway users are able to identify. The results are collected by field evaluations of highway conditions.

Organizational metrics are important for these organizations. Working with employees, management, and affected stakeholders, organizations involved in strategic planning can develop measures of performance in the production of goods and services and in meeting the organization’s most important objectives.

There is no single model or process for developing performance objectives and measures, nor is there a process that will guarantee good results. We have attempted to synthesize lessons learned from the literature as well as the insights gained from our surveys and work with agencies in applying performance measurement to the management of snow and ice control operations issues.

Applying a Performance Framework or Toolbox

One method used to develop performance measurements for snow and ice control is to apply a framework or toolbox to the problem. A performance measure toolbox brings structure to performance planning and clarifies the connection between activities, outputs, and results. The toolbox uses the following steps relative to the objectives specified in an agency’s strategic plan:

1. Confirm snow and ice control operations role. The rationale here is to determine why the agency is measuring performance. The agency should define the role that snow and ice control operations are intended to play with respect to strategic objectives and should provide a basis for establishing overall targets and performance measures.

2. Identify the key snow and ice control activities and oOutputs. The rationale for this step is to ensure that winter maintenance managers and staff focus on key issues that contribute to the achievement of the department's strategy for snow and ice control operations.

3. Identify stakeholders and issues. The rationale for this step, in order to formulate a set of snow and ice control objectives, is to identify the customers whom the winter maintenance activities and outputs should serve, influence, or target; the other principal groups affected; and the ways these groups are affected.

4. Identify what the snow and ice control operations aim to accomplish. The rationale for this step is to illustrate that the results are defined in terms of outcomes that then become the focus for determining appropriate objectives, milestone targets, and measures, e.g., that managers receive appropriate feedback.

5. Identify responses and performance requirements. The rationale for this step is that performance objectives must be defined in operational terms to be managed effectively.

CONCLUSIONS

Achieving reliable and relevant performance data for a snow and ice control performance measurement program is a large task for any organization. The challenges and problems associated with performance measurement are multiplied by the unpredictable nature of working with winter weather.

Complex factors influence the usefulness of performance measures. First, the performance measures must be perceived as reliable. Straightforward processes are best suited for obtaining reliable data because complexities can cause variations in reporting. Furthermore, each district or garage should have a clear understanding of what to include and exclude from the performance measurement program. The program should also involve key people in the creation of performance target definitions and in the reexamination of existing definitions and measures.

In addition to reliability, relevance is a key ingredient in data use. As discussed, relevance takes many shapes, and managers and jurisdictions each have their own unique needs. Factors influencing relevance include managerial control, timeliness, fruitfulness, organizational capacity, and the organizational philosophy of performance measures. This is not an exhaustive list, yet it is enough to demonstrate that achieving data use is not effortless.

Agencies may be able to improve their snow and ice control services by measuring the effectiveness of services they provide. Measuring performance, or the results of services, provides several benefits. The results can demonstrate value to taxpayers. Knowing the results of the service allows an agency to tell whether it has accomplished its intended objectives, and, if necessary, adjust its procedures or practices. Concentrating on results also helps agencies be more responsive to the needs of their customers and may help agencies communicate more effectively with taxpayers.

The research revealed the organizational objectives associated with snow and ice control performance measures. These objectives relate to the inputs, outputs, and outcomes of snow and ice control operations as follows:

- Accounting for inputs used for snow and ice control,
- Accounting for outputs accomplished,
- Operational efficiency, and

- Meeting outcome goals
 - Highway safety,
 - Highway mobility,
 - Public satisfaction, and
 - Controlling negative environmental impacts.

Many snow and ice control agencies have not moved beyond collecting performance data to utilizing these data to proactively manage the agency. A successful snow and ice performance program relies on the ability to obtain meaningful data, use these data to manage the program, and institutionalize these practices so that they become routine. Leadership is important to promote understanding and support for the organizational mission, and leadership demonstrates commitment to managing for results. Staff must buy into the program and feel empowerment and continuity. Finally, the results of performance management must be communicated among relevant stakeholders. This is crucial to the success of any performance measurement or management system.

While performance measurement is beginning to become more common, very few snow and ice control agencies are actively involved in using those data to proactively manage. In other words, performance measurement has not yet become performance management. Careful planning, consistent implementation, and thorough communication will help shift the snow and ice control agency beyond performance data collection to effective performance management.

Benefits and Costs of Winter Maintenance

BENEFITS AND COSTS OF WINTER MAINTENANCE

**Benefits and Costs Associated with
Maintenance Decision Support Systems****CHRISTOPHER K. STRONG***Western Transportation Institute***DAVID L. HUFT***South Dakota Department of Transportation*

Maintenance decision support systems (MDSS) are evolving software technologies that synthesize information on current and forecast weather conditions with properties about the road environment to provide forecasts for future pavement conditions, as well as recommend winter maintenance treatments. MDSS has been anticipated to provide benefit to transportation agencies in supporting more proactive treatment of roadways and providing more scientifically grounded roadway treatment recommendations, resulting in potential savings in winter maintenance costs and improved levels of service. The South Dakota Department of Transportation has partnered with 11 other states and a private-sector contractor in a pooled-fund study (PFS) to develop and deploy MDSS. Participating agencies have generally been supportive of MDSS technology and are interested in seeing its use grow. One major barrier to further implementation has been the lack of quantifiable benefit–cost information. This paper highlights the results of independent research that examined the benefits and costs associated with MDSS. The research project used a case study approach, examining multiple states among the PFS members. The benefits of MDSS were estimated by using MDSS as a tool to simulate the road conditions resulting from following MDSS treatment recommendations, as well as those resulting from following agencies’ standard rules of practice. The analysis considered potential agency benefits (i.e., reduction in winter maintenance costs) as well as motorist benefits (i.e., safety improvements and delay reduction) and costs involved with vendor support for MDSS and agency costs required to optimize MDSS functionality. In addition to economic benefits and costs, the research examined intangible benefits and costs that may affect an agency’s willingness to adopt MDSS. Based on one of two nationally recognized benefit–cost studies on MDSS, this paper provides valuable information to agencies considering MDSS implementation, as well as to private-sector entities considering entering the market to provide MDSS capabilities. Other contributors to this research include Xianming Shi and Laura Fay of the Western Transportation Institute and Moe Zarean and Steven Conger of Iteris, Inc.

BENEFITS AND COSTS OF WINTER MAINTENANCE

A Snow Removal Cost Estimation Model Using the Snow Removal Unit Cost Curve

SHIGEYUKI NAKAMAE

Ministry of Land, Infrastructure, and Transport

JUNICHI OSHIMA

Snow Research Center

TAKAHIRO OKAWADO

FUMIHIRO HARA

Hokkaido Development Engineering Center

SHIN-EI TAKANO

Hokkaido University

Many of Japan's large cities are in snowy regions, and snow removal plays an important role in securing smooth road traffic in winter (Figure 1).

Studies have addressed various aspects of road snow removal. The first in Japan on the economic benefit of road snow removal was done by Igarashi et al. (1), who measured that benefit that had been thought to be extremely difficult to measure, by applying the law of conservation of traffic work load, in which the traffic work load in an area remains unchanged when the economy or state of society remains unchanged. It was a pioneering study on road snow removal and cost–benefit analysis. The authors (2) further suggested a method for positioning snow removal machinery of the regional administration such as to minimize the total snow removal cost. The “total snow removal cost” is defined as the sum of snow removal cost and traffic hindrance cost; for a given snow removal cost, the total snow removal cost can be minimized if the traffic hindrance cost is minimized by placing the snow removal station. Sakai et al. (3) calculated the benefit of snow removal by dividing the mitigation of economic loss achieved by snow removal (i.e., the loss in the case of snow removal minus the estimated loss in the case of no snow removal) by the snow removal cost.

In a recent study on weighing the overall public interest against the requests and complaints of individual residents regarding road snow removal, Hara et al. (4) pointed out that, in snowy regions, responding to individual requests regarding road snow removal can conflict with the general public interest. To solve this dilemma, the authors suggested a structural strategy and a psychological strategy. Kishi et al. (5) suggested ways for the road administrator to provide snow removal services by clarifying the level of snow removal desired by residents and their willingness to pay for the snow removal that would attain that level. Takano et al. (6) analyzed how the provision of information on snow removal services by the road administrator influenced the residents' satisfaction and the effectiveness of that provision by focusing on citizen consensus building and public involvement. Nakamae et al., Kishi et al., and Tsukahara et al. (7, 8, 9) studied the financial risks incurred by the local governments and private companies that take part in snow removal. They suggested that local governments use risk financing, such as through

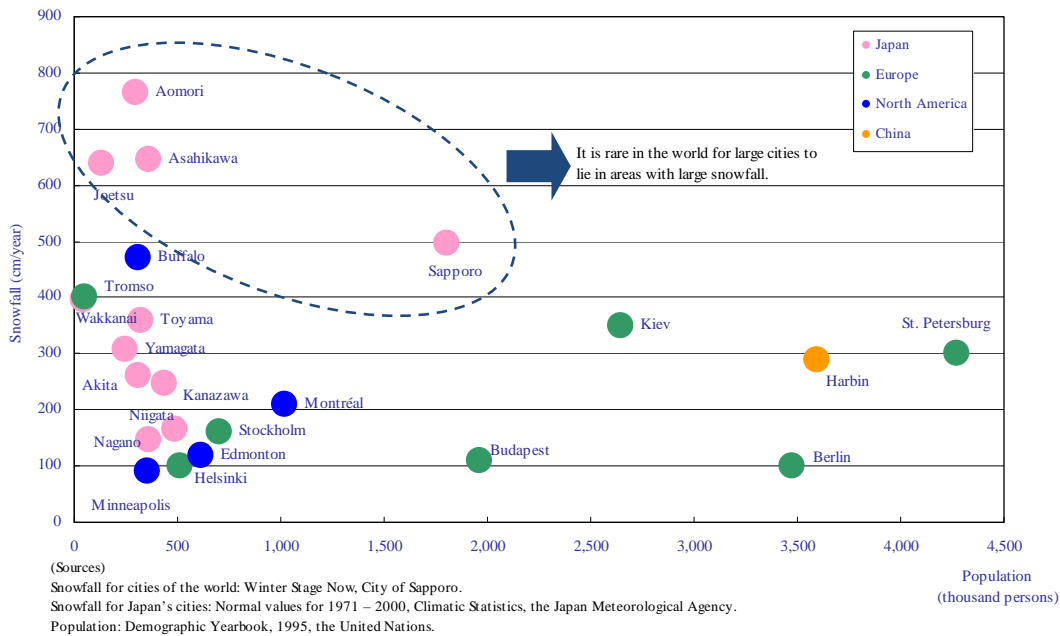

FIGURE 1 Snowfall of major cities in Japan and overseas.

insurance or derivatives, to even out yearly swings in snow removal cost.

Most of these studies on snow removal addressed economic benefits or used questionnaire surveys to address public involvement or customer satisfaction. Very few in-depth studies have addressed the cost structure of snow removal by the national government.

Snowfalls in winters of the past several decades have tended to be small. The winter of 2006 was the first in 43 years with extremely heavy snowfall in Japan, and the Japan Meteorological Agency designated it “the heavy snowfall of 2006.” Prefectural and municipal snow removal budgets were exhausted, and the Ministry of Land, Infrastructure, and Transport (MLIT) responded to local governments’ requests by increasing snow removal subsidies. On that occasion, MLIT was asked to estimate snow removal costs objectively by using data such as snowfall and length of road with snow removal. However, no method for such estimation had been established.

PURPOSES OF THE STUDY

In Japan, reduction of costs for public services has been an important issue. This is particularly true for reduction of snow removal cost. It is necessary to address the issue systematically. To reduce snow removal cost at the national level, it is necessary to (a) analyze the structure of snow removal cost, (b) develop a method for interregional comparison of such cost, and (c) set standards for cost reduction. Interregional comparison of snow removal cost has been regarded as complicated, because the cost varies with snowfall amount, air temperature, snow texture and other natural phenomena; with the degree of development (e.g., urban versus rural); and with social conditions, including how accustomed the road users are to snowfall.

This paper reports on the development of an objective evaluation method to estimate

snow removal cost by clarifying the relationship between snow removal cost and cumulative snowfall, both of which are relatively easy to obtain, and on the development of a method for interregional comparison of snow removal costs using the developed estimation method.

RELATIONSHIP BETWEEN CUMULATIVE SNOWFALL AND SNOW REMOVAL COST

Generally, the snow removal cost for roads (snow removal cost) consists of the costs for the following: (a) carriageway snow removal, (b) sidewalk snow removal, (c) antifreezing agent application, (d) snow hauling, and (e) miscellaneous. The costs for roadway and sidewalk snow removal depend on the amount of snowfall. The cost for antifreezing agent application depends on the amount of snowfall and the air temperature. The cost for snow hauling depends on the amount of snow only after the snow accumulated on the right-of-way exceeds a certain threshold. The value does not vary constantly with increases in snowfall; instead, it changes in stepwise increments.

Two kinds of data represent the amount of snowfall: snowfall per snowfall event and annual snowfall. Snow removal deployment is launched in response to each day's snowfall. When we examine the cost for snow removal, it is appropriate to use cumulative snowfall.

The structure of snow removal cost is complicated, as shown above. The cost varies depending on the snowfall, and can be expressed in the following equation.

$$p = f(x) \quad (1)$$

where p is the snow removal cost and x is the cumulative snowfall.

This function is expected to plot as an upward-sloping curve because snow removal cost increases with increases in cumulative snowfall. The total snow removal cost, however, includes costs that are independent of snowfall amount, including the cost for antifreezing agent application and fixed operating costs. The function has terms that change and terms that do not change (constant terms) with changes in cumulative snowfall.

If we assume that a linear approximation can describe the relationship between snow removal cost and cumulative snowfall (Figure 2), then the snow removal cost can be expressed by Equation 2.

$$p = f(x) = ax + b \quad (2)$$

where

p = snow removal cost,
 x = cumulative snowfall, and
 a, b = coefficient of areas.

The snow removal cost expressed in the above equation includes the cost for hauling snow, which increases in stepwise increments with increases in cumulative snowfall (Figure 3).

The snow removal cost includes a cost that changes in stepwise increments, and it is thought that the curve that expresses the relationship between snow removal cost and cumulative

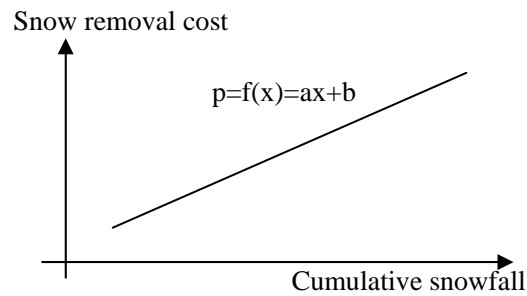

FIGURE 2 Snow removal cost versus cumulative snowfall.

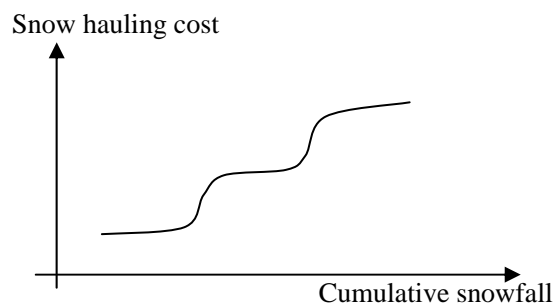

FIGURE 3 Snow hauling cost versus cumulative snowfall.

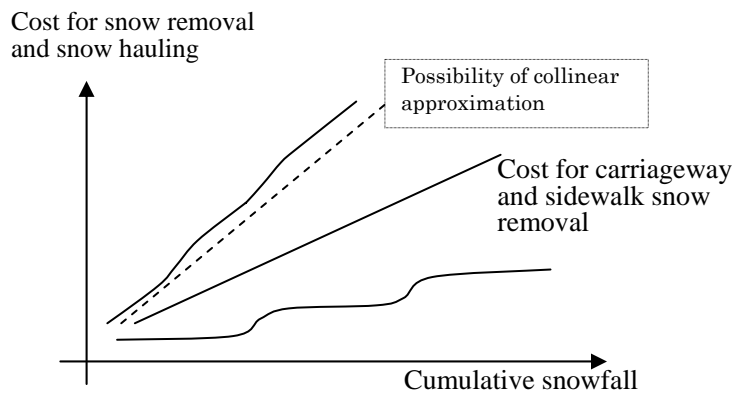

FIGURE 4 Cost for snow removal and snow hauling versus cumulative snowfall.

snowfall is not a simple curve. However, when the cost for hauling snow does not take dominate the total snow removal cost, it is considered that a linear approximation can describe the relationship between snow removal cost and cumulative snowfall (Figure 4).

Next, we examine the relationship between snow removal unit cost and cumulative snowfall.

The snow removal unit cost, which is obtained by dividing the annual snow removal cost

$[p, (\text{million yen})]$ by the length of road with snow removal $[L (\text{km})]$ and cumulative snowfall $[x (\text{cm})]$, is expressed as follows.

$$y = p/L/x \quad (3)$$

The length of road with snow removal is the length of routes designated under the Act on Special Measures Concerning Securing Road Traffic in Special Areas in Snowy Cold Regions (the snow and cold law), which can be treated as a constant because it does not change with changes in cumulative snowfall (x).

From Equations (2) and (3), we obtain

$$\begin{aligned} y &= f(x)/L/x \\ &= (a+b/x)/L \end{aligned} \quad (4)$$

Generally, a power function is expressed as

$$y = ax^b + c \quad (5)$$

When b is -1 , Equation 5 can be rewritten as Equation 4. The snow removal unit cost can be expressed as a power function of cumulative snowfall.

In Equation 5, c is not dependent on cumulative snowfall (x), and when b is negative, the snow removal unit cost y arbitrarily closely approaches c as x increases.

The work time and cost required to remove 5 cm of snowfall does not differ much from that required to remove 6 cm of snowfall. The work time required to remove 10 cm of snowfall is longer than that to remove 5 cm of snowfall, but not twice as long. From this example, it can be thought that the snow removal unit cost decreases with increases in cumulative snowfall.

As we discussed, the snow removal cost includes costs that are not dependent on the cumulative snowfall, which means that the snow removal unit cost cannot fall below a certain value. In light of this, snow removal unit cost plots as a downward sloping curve with a downward convex on the graph with unit cost on the y -axis and cumulative snowfall on the x -axis.

To approximate the snow removal unit cost, it is appropriate to use the power function of cumulative snowfall.

CORRELATION BETWEEN SNOW REMOVAL UNIT COST AND CUMULATIVE SNOWFALL DETERMINED USING THE SNOW REMOVAL DATA

The relationship between snow removal unit cost and cumulative snowfall is examined here using previous records. Approximation of that relationship is done by using a power function for previous snow removal cost and cumulative snowfall for roads subject to the snow and cold law.

Correlation Using the Snow Removal Data of Each Prefecture

Snow removal unit cost correlates extremely closely with cumulative snowfall for Niigata, Toyama, and Ishikawa Prefectures, which are under the jurisdiction of the Hokuriku Regional Development Bureau, Ministry of Land, Infrastructure, and Transport. The contribution rate is 0.88 (correlation coefficient of -0.94) (Figure 5).

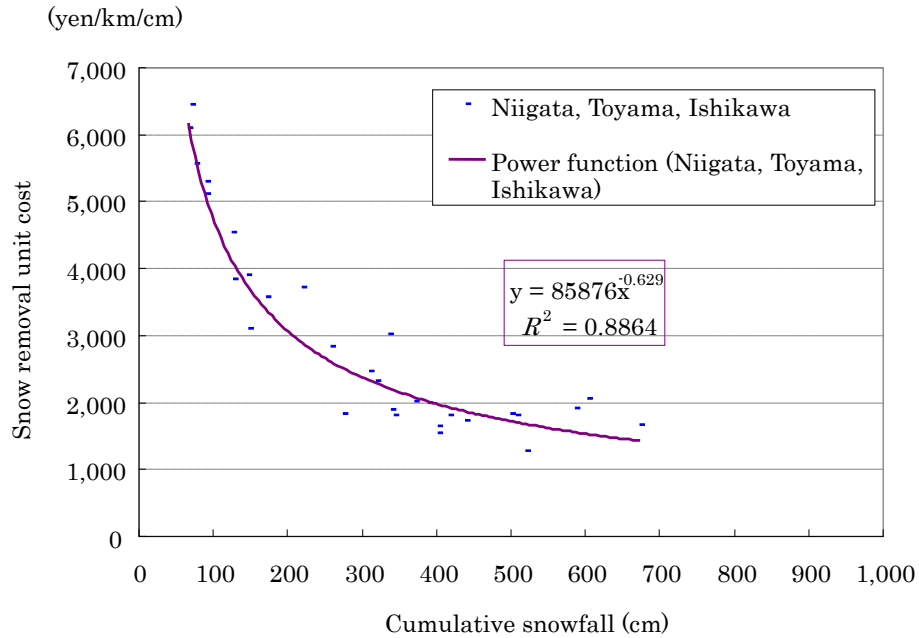

FIGURE 5 Snow removal unit cost curve for the Hokuriku region (Niigata, Toyama, Ishikawa).

For Tottori Prefecture, in the Sanin region, the snow removal unit cost correlates closely with cumulative snowfall, with a contribution rate of 0.81 (correlation coefficient of -0.90); however, that correlation for Shimane and Yamaguchi Prefectures is low, with a contribution rate of 0.19 (correlation coefficient of -0.44) (Figure 6). An approximation curve of the relationship was obtained for five of the six prefectures in the Tohoku region, excluding Aomori Prefecture; the correlation coefficient for those five prefectures was low, -0.31 (Figure 7). We assume that the snow removal unit cost differs, depending on the climate and other regional characteristics, and we obtained one approximation curve for the prefectures on the Japan Sea side of the Tohoku region and another for those on the Pacific side of that region. Under such a division, the correlation is higher, with a correlation coefficient of -0.63 for the Japan Sea side group and a correlation coefficient of -0.75 for the Pacific side group. This examination confirmed that areas with similar natural and local conditions have similar trends in the relationship between the snow removal unit cost and cumulative snowfall, and it is possible to group more than two prefectures for this examination (Figure 8).

Correlation Using the Snow Removal Data for National Highways Administered by the National Government

A scatter plot of snow removal data for nationally managed national highways administered by the regional development bureaus reveals three groups. The first is roads administered by the Kanto Regional Development Bureau (Group A), for which the data points cluster around a higher region in the graph than the data points for other groups. The second is roads administered by the Chugoku Regional Development Bureau, for which the data points cluster in the lower region (Group B). The third is roads administered by the Hokkaido Regional Development

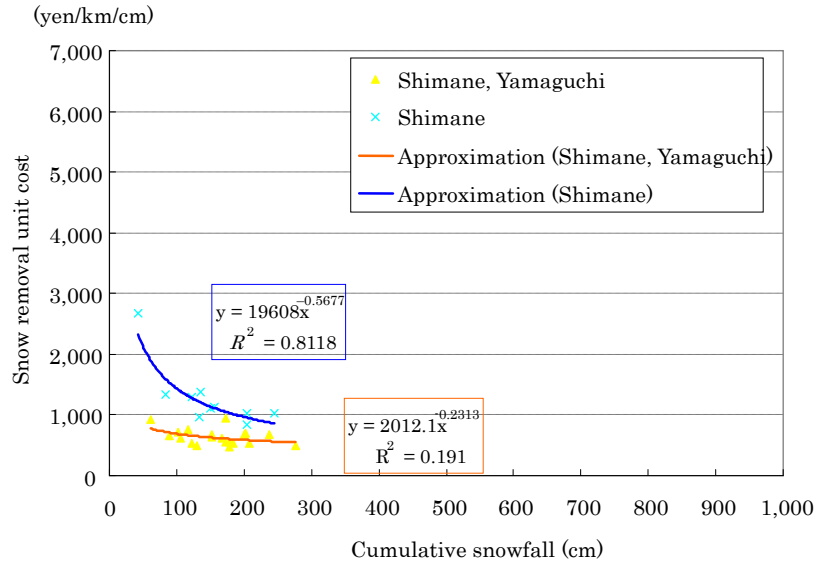

FIGURE 6 Snow removal unit cost curve for the Sanin region (Tottori, Shimane, Yamaguchi).

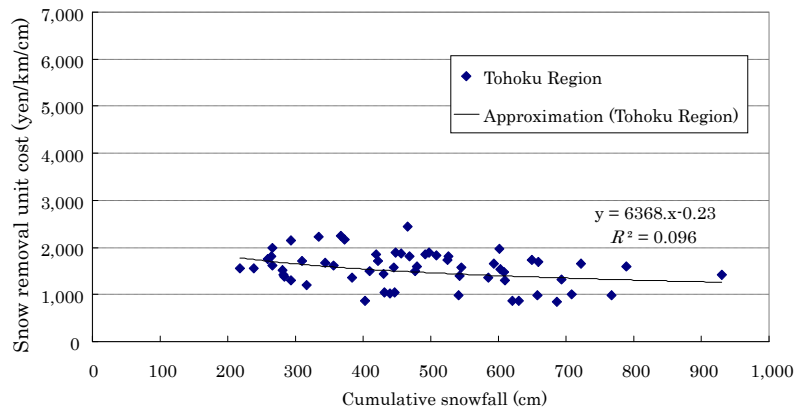

FIGURE 7 Snow removal unit cost curve for the Tohoku region (excluding Sendai City).

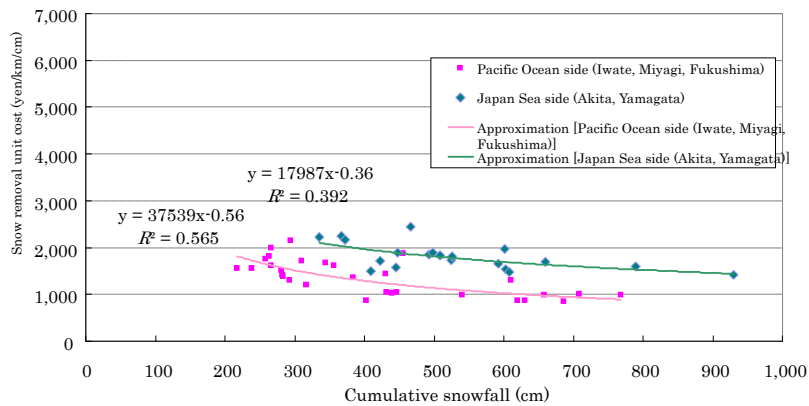

FIGURE 8 Snow removal unit cost curves for the Japan Sea prefectures of the Tohoku region (excluding Aomori City and Sendai City) and the Pacific prefectures of that region.

Bureau and other regional bureaus excluding the Kanto and Chugoku Regional Development Bureaus, for which the data points distribute along a curved region (Group C) between the regions for Groups A and B (Figure 9).

Figure 10 shows a curve correlating the unit cost of snow removal and the cumulative snowfall for all national highways administered by the national government (see also Table 1). Figure 11 shows that curve for Group C. The correlation coefficient for the former is -0.50 , and that for the latter is high: -0.88 . In light of this, we assume that there are three snow removal unit cost curves. Group C can be explained by using one snow removal unit cost curve. For Group A, whose curve is the upper-rightmost curve, the snow removal unit cost is high. For Group C the snow removal cost is low.

Correlation Coefficients for Regions

It was found that the correlation coefficient for prefectures in the Chubu region was low for national highways administered by the national government, and the correlation coefficients for Iwate, Gunma, and Okayama Prefectures were particularly low for prefecturally managed national highways. It was found that the correlation coefficients tended to be high for areas on the Japan Sea side of the Tohoku and Hokuriku regions, where the cumulative snowfall was large. For the areas such as Chugoku, where the cumulative snowfall was small, and the Kanto and Tohoku areas on the Pacific coast, where cold areas accounted for a high proportion of the overall area, the correlation coefficients were relatively low.

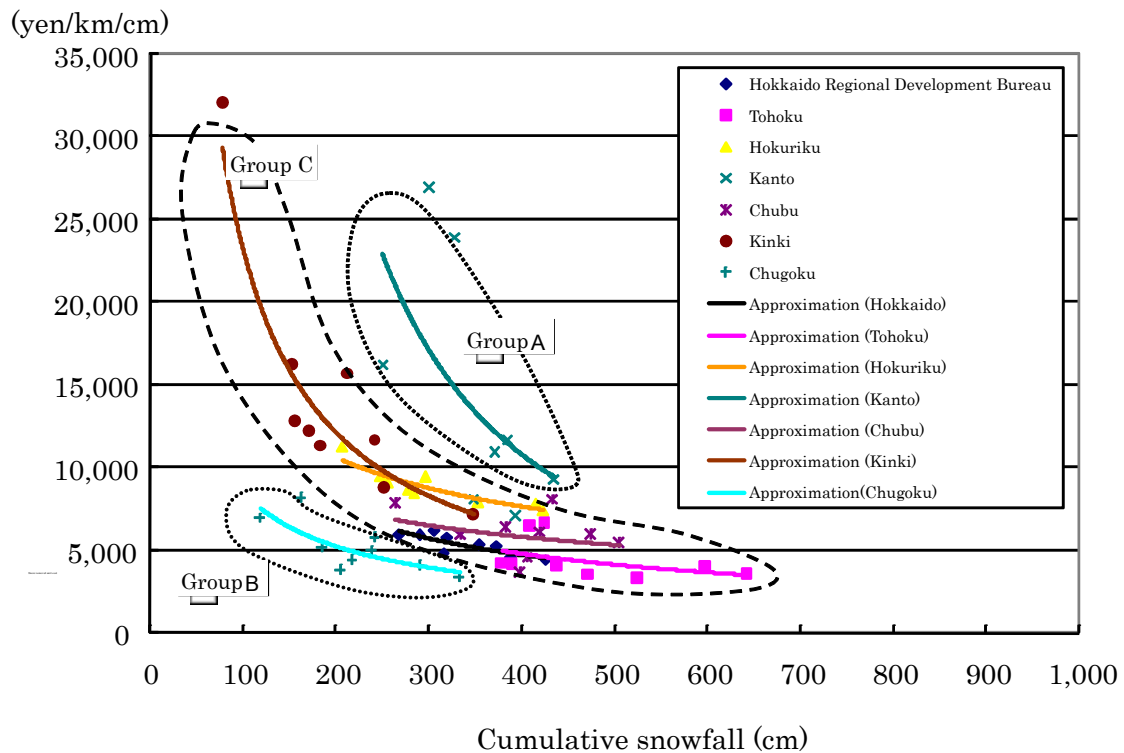

FIGURE 9 Snow removal unit cost curve for each regional development bureau.

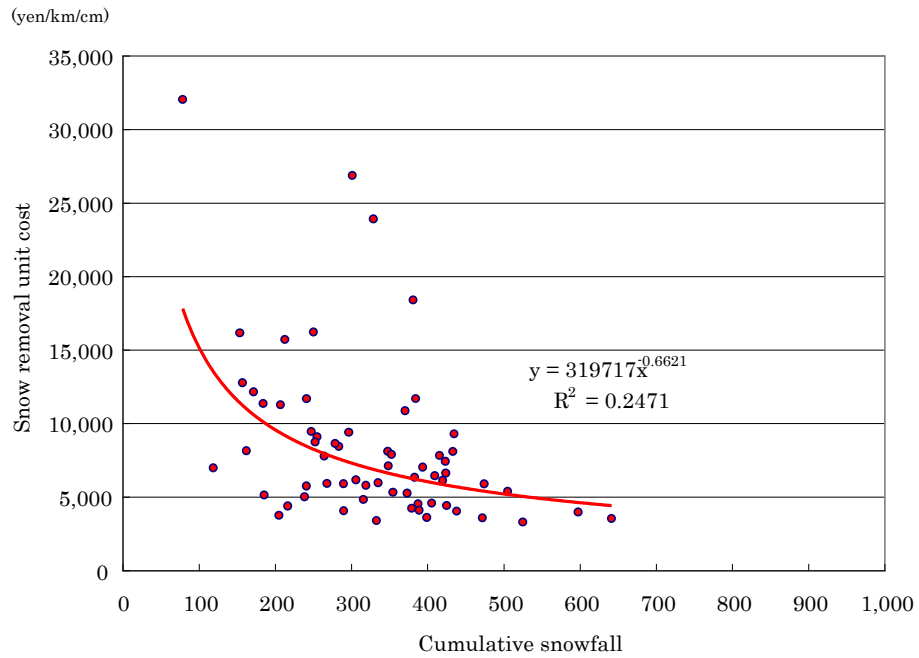

FIGURE 10 Snow removal unit cost curve for all government-managed national highways.

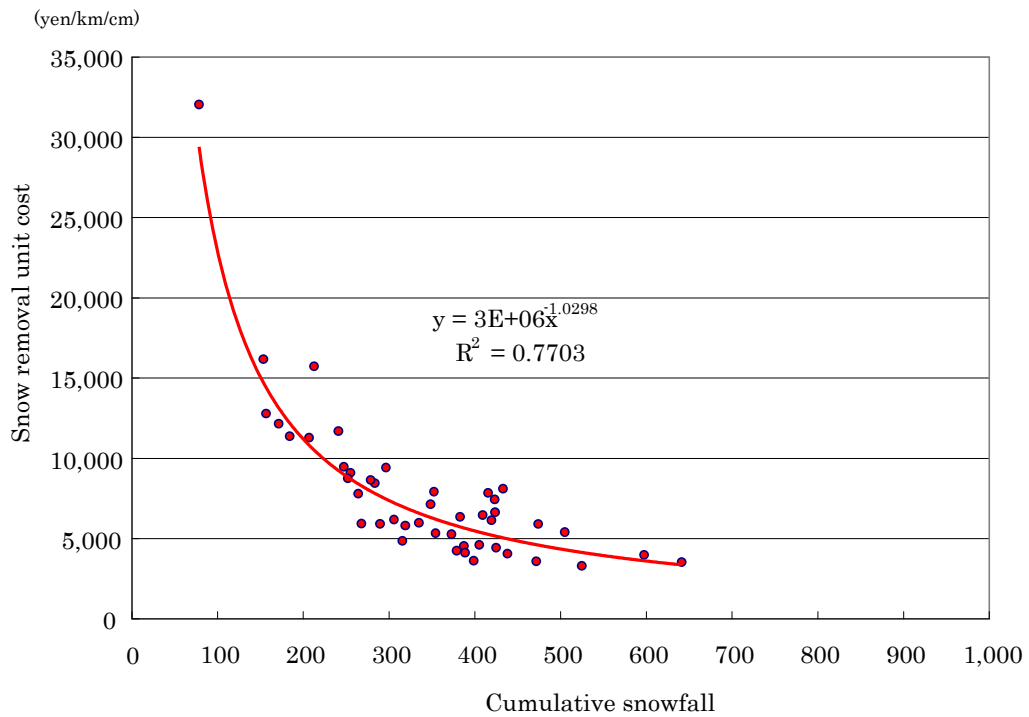

FIGURE 11 Snow removal unit cost curve for Group C.

TABLE 1 Unit Cost of Snow Removal vs. Cumulative Snowfall: Correlation Coefficients for National Highways Managed by the National Government and Those Managed by Prefectures

Regional Development Bureau	Prefecture	National Government Managed		Subsidized	
		Contribution Rate	Correlation Coefficient	Contribution Rate	Correlation Coefficient
Hokkaido Regional Development Bureau	Hokkaido Sapporo City	0.666	-0.816	0.581	-0.762
Tohoku region	Aomori	0.264	-0.514	0.175	-0.419
	Iwate			0.021	-0.146
	Miyagi			0.313	-0.560
	Sendai City				
	Akita			0.394	-0.627
	Yamagata			0.753	-0.868
Kanto region	Fukushima			0.308	-0.555
	Tochigi	0.315	-0.561	0.196	-0.442
	Gunma			0.071	-0.266
Nagano	0.479			-0.692	
Hokuriku region	Niigata	0.907	-0.952	0.393	-0.627
	Toyama			0.699	-0.836
	Ishikawa			0.892	-0.945
Chubu region	Gifu	0.095	-0.308	0.249	-0.499
Kinki region	Fukui	0.853	-0.923	0.235	-0.485
	Shiga			0.924	-0.961
	Kyoto			0.534	-0.731
	Hyogo			0.276	-0.525
Chugoku region	Tottori	0.585	-0.765	0.812	-0.901
	Shimane			0.198	-0.445
	Okayama			0.013	-0.113
	Hiroshima			0.233	-0.483
	Yamaguchi			0.247	-0.497

Detailed analyses are necessary for understanding the reasons for the low correlation in these areas. One possible reason is that in Iwate Prefecture or Gunma Prefecture, areas that tend to have low temperatures and little snowfall account for a low proportion of the overall area, which results in high cost for antifreezing agent application. For Okayama Prefecture, where snowfall is small, a possible reason for the low correlation coefficient is that fixed cost accounts for a large share of the total snow removal cost.

COST COMPARISON USING THE SNOW REMOVAL UNIT COST CURVE

Cost Efficiency of Snow Removal for Each Prefecture

The snow removal unit cost curve is an empirical formula obtained from snow removal records.

By using this curve, it is possible to estimate the unit cost of snow removal that corresponds to a particular cumulative snowfall. It is possible to use the snow removal unit cost curve for a prefecture to evaluate the cost efficiency of its snow removal for any given year by comparing the estimated snow removal cost and the actual cost expended.

Interprefectural Comparison of Cost Efficiency

The snow removal unit cost for the areas on the Japan Sea side of Tohoku and those in Hokuriku is expressed by one curve with a relatively high correlation. It is possible to compare snow removal costs of prefectures that share the same snow removal unit cost curve.

ALLOCATION OF PUBLIC SNOW REMOVAL BUDGET USING THE SNOW REMOVAL UNIT COST CURVE

National government subsidies for snow removal for FY 2005 were allocated by totaling the prefectural budgets for snow removal and allocating the subsidy according to each prefecture's share of the combined prefectural snow removal budgets. By using the snow removal unit cost curve based on the observed cumulative snowfall data of each prefecture, it is possible to estimate the prefectural snow removal budget. The snow removal unit cost curve is expressed as $y = ax^b$. The coefficients a and b are obtained for each prefecture, and they vary depending on differences in the cost of snow removal, the snow removal method, and the standard for starting snow removal operations. These coefficients are referred to as area coefficients.

For comparison, the estimated total snow removal cost based on cumulative snowfall and the snow removal budget allocated for FY 2005 are shown in [Table 2](#).

Although the deviation is great for Gifu Prefecture, Fukui Prefecture, and the Sanin Region, the difference between the estimated and allocated amounts for Hokkaido Prefecture, Nagano Prefecture, the Tohoku region, and the Hokuriku region is roughly within a 30% deviation.

On the basis of the results, it was decided to continue accumulating data toward refining the snow removal unit cost curve and to use the curve for budgeting. The national government has been using the snow removal unit cost curve to allocate subsidies since FY 2006.

SUMMARY

Important Points

The following are the important points of this study:

- A model for analyzing the relationship between the snow removal cost and cumulative snowfall using the snow removal unit cost curve was proposed;
- Snow removal cost comparison using the snow removal unit cost curve was suggested; and

TABLE 2 Snow Removal Cost Allocation: Cost Estimated Using the Snow Removal Unit Cost Curve and That Allocated for FY 2005

	Snow removal unit cost curve	Area coefficient		Length of road with snow removal	Cumulative snowfall	Estimated unit cost	Allocated unit cost	Estimated snow removal cost	Allocated snow removal cost	Estimation accuracy
	Yen/km/cm	a	b	km	cm	yen/km/cm	yen/km/cm	Yen	Yen	%
Hokkaido Pref.	y = ax ^b	37733	-0.5148	9,997	426	1,671	1,442	7,118,000,000	6,140,390,000	86.3%
Sapporo City		131269	-0.479	276	547	6,407	5,542	967,000,000	836,699,000	86.5%
Aomori Pref.		8745.9	-0.272	2,946	530	1,588	1,933	2,479,000,000	3,018,000,000	121.7%
Iwate Pref.		754.12	0.1331	3,050	395	1,671	1,446	2,013,000,000	1,742,000,000	86.5%
Miyagi Pref.		16263	-0.4146	1,024	441	1,303	1,397	588,000,000	631,000,000	107.3%
Sendai City		5235.9	-0.0529	141	528	3,758	3,224	280,000,000	240,000,000	85.7%
Akita Pref.		55584	-0.559	2,779	569	1,603	2,262	2,534,000,000	3,577,000,000	141.2%
Yamagata Pref.		17528	-0.3606	2,740	890	1,514	1,607	3,693,000,000	3,919,688,000	106.1%
Fukushima Pref.		3838.2	-0.2174	1,983	867	882	1,023	1,516,000,000	1,758,000,000	116.0%
Tochigi Pref.		32569	-0.5181	516	343	1,582	1,669	280,000,000	295,417,000	105.5%
Gunma Pref.		8805.7	-0.2388	705	626	1,892	2,574	835,000,000	1,136,137,000	136.1%
Nagano Pref.		664723	-0.9253	1,998	483	2,184	2,075	2,107,000,000	2,002,176,000	95.0%
Niigata Pref.		11269	-0.2882	5,130	699	1,707	2,307	6,119,000,000	8,274,076,000	135.2%
Toyama Pref.		200000	-1.1353	2,263	708	1,162	1,347	1,863,000,000	2,157,900,000	115.8%
Ishikawa Pref.		105843	-0.6725	2,138	255	2,548	3,382	1,389,000,000	1,843,877,000	132.7%
Gifu Pref.		20245	-0.4304	1,621	557	1,332	2,270	1,203,000,000	2,049,653,000	170.4%
Fukui Pref.		12097	-0.3407	1,799	373	1,609	3,083	1,080,000,000	2,069,000,000	191.6%
Shiga Pref.		44453	-0.5507	852	327	1,833	2,419	511,000,000	674,000,000	131.9%
Kyoto Pref.		10944	-0.4202	1,370	271	1,040	1,530	386,000,000	568,000,000	147.2%
Hyogo Pref.		21598	-0.4385	817	559	1,348	1,758	616,000,000	803,000,000	130.4%
Tottori Pref.	19608	-0.5677	1,556	291	783	1,026	354,000,000	464,670,000	131.3%	
Shimane Pref.	1323	-0.1464	1,714	294	576	868	290,000,000	437,540,000	150.9%	
Okayama Pref.	632.62	-0.0699	837	302	424	1,000	107,000,000	252,790,000	236.3%	
Hiroshima Pref.	25110	-0.7346	1,264	780	189	549	186,000,000	541,000,000	290.9%	
Yamaguchi Pref.	3844.8	-0.3652	548	333	461	554	84,000,000	101,009,000	120.2%	

- Issues regarding budget allocation using the snow removal unit cost curve were successfully addressed; this has enabled the method to be applied to budgeting by the national government.

Items to Be Improved

The following list shows the items that shall be examined for improvement of the accuracy of snow removal cost estimation and further reductions in snow removal cost:

- Comparison between prefectural and national government data;
- Analysis of reasons for the low correlation between unit cost of snow removal and cumulative snowfall of some prefectures, which will enable better comparison with nearby prefectures;
 - Examination of the correlation between cumulative snowfall and snow removal unit cost after subtracting snowfalls smaller than the standard for launching snow removal operations (5 cm/day);
 - Examination of the correlation between the number of frost days and the amount of antifreezing agent applied;
 - Derivation of a correction term for improved snow removal budget allocation that

takes into account the approximation formula and the degree of dispersion of each data set;

- Examination of the influence of unit labor cost; and
- Examination using approximation zones that take data dispersion into account.

REFERENCES

1. Igarashi, H. et al. *Measurement of Economic Effect of Snow Removal on Roads*. Hokkaido Branch, Civil Engineering Association, 1969, pp. 295–302.
2. Igarashi, H. et al. Setting of an Objective Function for Road Snow Removal. *Proc., 11th Japan Road Conference*, 1971, pp. 607–608.
3. Sakai, T., et al. Evaluation Method for Road Snow Removal Cost. *Journal of the Japan Society of Snow and Ice*, Vol. 55, No. 4, 1993, pp. 327–334.
4. Hara, H., et al. Snow Issues and Social Dilemma. *Proc., 18th Cold Regions Technology Symposium*, 2002, pp. 621–624.
5. Kishi, H., et al. Evaluation of Snow Removal Standards and Willingness to Pay in Various Cities. *Proc., Conference of Infrastructure Planning*, No. 24, 2001, pp. 689–692.
6. Takano, S.-E., et al. Resident Satisfaction and the Effect of Information Provision by the Road Administrator Regarding Snow Removal Operations. *Collected Papers of the Construction Management Committee*, Vol. 8, 2000, pp. 45–52.
7. Nakamae, S., et al. Risk Hedging for Snow Removal and Examination on Utilization of Derivatives. *Yuki*, No. 46, 2002.
8. Kishi, H., et al. Equalizing Snow Removal Cost by Introducing Snow Removal Insurance. *Proc., Conference of Infrastructure Planning*, No. 22, 1999, pp. 67–80.
9. Tsukahara, S., et al. Creation of a Snow Control System That Takes Risk Financing into Consideration. *Proc., 57th Annual Conference of the Japan Society of Civil Engineers*, 2002, pp. 639–640.

APPENDIX

Author Contact Information

Jonathan Agüero-Valverde
Pennsylvania State University
University Park, Pennsylvania

Chris Albrecht
Center for Transportation Research and Education
Iowa State University
2711 South Loop Drive
Ames, Iowa 50010

Shawn Allan
AMEC Earth and Environmental

Jean Andrey
University of Waterloo
Waterloo, Ontario N2L 3G1, Canada
519-888-4567, ext. 3629; Fax: 519-746-0658
E-mail: jandrey@fes.uwaterloo.ca

Duane E. Ansler, Sr.
AFM Engineering Services

Motoki Asano
Civil Engineering Research Institute for Cold Region
1-3 Hiragishi, Toyohira-ku
Sapporo, 062-8602, Japan
+81-11-841-1116; Fax: +81-11-841-9747
E-mail: m-asano@ceri.go.jp

Mark A. Askelson
Department of Atmospheric Sciences and Surface
Transportation Weather Research Center
University of North Dakota
Clifford Hall Room 400
4149 University Avenue, Stop 9006
Grand Forks, North Dakota 58202-9006
701-777-6334; Fax: 701-777-5032
E-mail: askelson@aero.und.edu

Daniel Bättig
University of Applied Sciences, Berne
Pestalozzistr. 20
CH 3400 Burgdorf
Switzerland
+41-34-426-43-26
E-mail: daniel.baettig@bfh.ch

Bob Baron
Baron Services, Inc.

Rahim F. Benekohal
Department of Civil and Environmental Engineering
University of Illinois at Urbana-Champaign
1213 Newmark Civil Engineering Laboratory
MC-250
205 North Mathews Avenue
Urbana, Illinois 61801
217-244-6288; Fax: 217-333-1924
E-mail: rbenekoh@uiuc.edu

Romain Billot
Transport and Traffic Engineering Laboratory
25 Avenue François Mitterrand, Case 24
Bron cedex, F-69675, France
ENTPE, LICIT, Vaulx-en-Velin, 69518, France
Université de Lyon, Lyon, 69003, France
Université de Lyon 1
Lyon, 69003, France
romain.billot@inrets.fr
+33-0-472-142-566; Fax: +33-0-472-142-550

Göran Blomqvist
Swedish National Road and Transport
Research Institute
SE-581 95 Linköping, Sweden
+46-13-204-171; Fax: +46-13-141-436
E-mail: goran.blomqvist@vti.se

Alexander Brenning
University of Waterloo
Waterloo, Ontario N2L 3G1, Canada

Paul Bridge
Vaisala, Inc.
194 South Taylor Avenue
Louisville, Colorado 80027
303-262-4051; Fax: 303-499-1767
E-mail: paul.bridge@vaisala.com

Terry M. Bullock
AMEC Earth and Environmental

Alicia Carriquiry
Iowa State University
Ames, Iowa

Madhav V. Chitturi
University of Illinois at Urbana–Champaign
3150 Newmark Civil Engineering
Laboratory, MC-250
205 North Mathews Avenue
Urbana, Illinois 61801
217-333-8988
E-mail: mchittur@uiuc.edu

Diana Clonch
Ohio Department of Transportation
Columbus, Ohio 43223
E-mail: Diana.Clonch@dot.state.oh.us

James R. Cowie
National Center for Atmospheric Research
3450 Mitchell Lane
Boulder, Colorado 80301
303-497-2831; Fax: 303-497-8401
E-mail: cowie@ucar.edu

Thorsten Cypra
Boschung Mecatronic AG
Rte d'Englisberg 21
CH-1763 Granges-Paccot
Switzerland
+41-0-26-460-44-11; Fax: +41-0-26-460-44-88
E-mail: thorsten.cypra@boschung.com

Olivier de Mouzon
Transport and Traffic Engineering Laboratory
INRETS, LICIT
25 Avenue François Mitterrand, Case 24
Bron cedex, F-69675, France
ENTPE, LICIT, Vaulx-en-Velin, 69518, France
Université de Lyon, Lyon, 69003, France
Université de Lyon 1
Lyon, 69003, France
+33-0-472-142-584; Fax: +33-0-472-142-550
E-mail: olivier.de-mouzon@inrets.fr

Paul J. DeLannoy
AMEC Earth and Environmental
210 Colonnade Road., Unit #300
Ottawa, Ontario K2E 7L5, Canada
E-mail: paul.delannoy@amec.com

Bob Dreisewerd
Baron Services, Inc.

Sheldon Drobot
University of Colorado
UCB 431
Boulder, Colorado
303-492-8143; Fax: 303-492-2825
E-mail: drobot@colorado.edu

Arnaud P. Dumont
National Center for Atmospheric Research
3450 Mitchell Lane
Boulder, Colorado 80301
303-497-8434; Fax: 303-497-8401
E-mail: dumont@ucar.edu

Rodolphe Duval
Centre d'Etudes Techniques de l'Équipement de l'Est
Laboratoire Régional des Ponts et Chaussées
Nancy—ERA 31
71 Rue de la Grande Haie
54510 Tomblaine, France
+33-0-3-83-18-31-60; Fax: +33-0-3-83-18-41-41

Nour-Eddin El Faouzi
Transport and Traffic Engineering Laboratory
INRETS, LICIT
25 Avenue François Mitterrand, Case 24
Bron cedex, F-69675, France
ENTPE, LICIT, Vaulx-en-Velin, 69518, France
Université de Lyon, Lyon, 69003, France
Université de Lyon 1
Lyon, 69003, France
Phone: +33-0-472-142-543; Fax: +33-0-472-142-550
E-mail: elfaouzi@inrets.fr

F. Feng
University of Waterloo
200 University Avenue, West
Waterloo, Ontario N2L 3G1, Canada

Maurice François
Station d'Essais de Matériels Routiers
31 Rue Laplace, CS 2912
41029 Blois, France
+33-0-2-54-55-49-60; Fax: +33-0-2-54-55-49-60
E-mail: francois.maurice@equipement.gouv.fr,

L. Fu
University of Waterloo
200 University Avenue, West
Waterloo, Ontario N2L 3G1, Canada

Makoto Funahashi
Civil Engineering Research Institute for Cold Region
1-3 Hiragishi, Toyohira-ku
Sapporo, 062-8602, Japan
+81-11-841-1738; Fax: +81-11-841-9747
E-mail: m-funahashi@ceri.go.jp

Daniel R. Gallagher
Baron Services, Inc.
E-mail: dan.gallagher@baronservices.com

Charla Gaskins
North Carolina A&T State University
1601 East Market Street
Greensboro, North Carolina 27411
804-683-6828
E-mail: cgaskins@ncat.edu

Damon M. Grabow
University of North Dakota
4124 University Avenue
Grand Forks, North Dakota 58202-9007
701-777-2479; Fax 701-777-3888
E-mail: dgrabow@rwic.und.edu

Stephen Gray
New Hampshire Department of Transportation
7 Hazen Drive
Concord, New Hampshire 03302
E-mail: sgray@dot.state.nh.us

Jennifer Green
Surface Transportation Weather Research Center
University of North Dakota
3980 Campus Road, Stop 9007
Grand Forks, North Dakota 58202-9007
701-777-2479; 701-777-4898; Fax: 701-777-3888

Patrick Grover
4DM, Inc.
671 Danforth Avenue, Suite 305
Toronto, Ontario M4J 1L3

Pontus Gruhs
Swedish Road Administration
SE-781 87 Borlänge, Sweden
+46-243-75-482; +46-70-624-44-50
E-mail: Pontus.gruhs@vv.se

Pierre Guillevic
Laboratoire Central des Ponts et Chaussées
Route de Bouaye, BP 4129
44341 Bouguenais Cedex, France
+33-0-2-40-84-58-00; Fax : +33-0-2-40-84-59-99
E-mail: pierre.guillevic@lpc.fr

Mats Gustafsson
Swedish National Road and Transport
Research Institute
SE-581 95 Linköping, Sweden
+46-13-204-326; Fax: +46-13-141-436
E-mail: mats.gustafsson@vti.se

Don Halliday
Halliday Technologies, Inc.
Plain City, Ohio 43064
E-mail: don.halliday@hallidaytech.com

Fumihito Hara
Hokkaido Development Engineering Center
+81-11-271-3022; Fax: +81-11-271-5366

Robert D. Hart
Meridian Environmental Technology, Inc.
4324 University Avenue, Suite B
Grand Forks, North Dakota 58203
701-792-1800; Fax: 701-792-1831
E-mail: bobhart@meridian-enviro.com

B. Hashemloo
University of Waterloo
200 University Avenue, West
Waterloo, Ontario N2L 3G1, Canada

Benjamin W. Hershey
Meridian Environmental Technology, Inc.
4324 University Avenue, Suite B
Grand Forks, North Dakota 58203
701-792-1800; Fax: 701-792-1831
E-mail: bhershey@meridian-enviro.com

Ivar Hol
Norwegian Public Roads Administration
Fylkeshuset
N-6425 Molde, Norway
+47-71-274-219
E-mail: ivar.hol@vegvesen.no

David L. Huft
South Dakota Department of Transportation
700 East Broadway
Pierre, South Dakota 57501-2586
605-773-3358; Fax: 605-773-4713
E-mail: dave.huft@state.sd.us

Nathan Huynh
North Carolina A&T State University
1601 East Market Street
Greensboro, North Carolina 27411
336-334-7737
E-mail: nnhuynh@ncat.edu

Per Jonsson
Swedish National Road and Transport
Research Institute
SE-581 95 Linköping, Sweden
+46-13-204-219; Fax: +46-13-141-436
E-mail: per.jonsson@vti.se

Paul P. Jovanis
Pennsylvania State University
212 Sackett Building
University Park, Pennsylvania 16802-1408
814-865-9431; 814-863-7304
E-mail: ppj2@engr.psu.edu

Yasuhiko Kajiya
Civil Engineering Research Institute for Cold Region
Public Works Research Institute
1-3 Hiragishi Toyohira-ku
Sapporo, Hokkaido, 062-8602, Japan
+81-11-841-5553 ; Fax: +81-11-841-9747
E-mail: ykajiya@ceri.go.jp

Patrick J. Kennedy
Federal Highway Administration
1200 New Jersey Avenue, SE, HOTO-1
Washington, D.C. 20590
202-366-9498; 202-366-3225
E-mail: pat.kennedy@dot.gov

William (Pat) Kennedy
City and County of Denver
1390 Decatur Street
Denver, Colorado 80204
720-865-6850; Fax: 720-865-6885
E-mail: william.kennedy@denvergov.org

Dennis Kirchoff
University of Waterloo
Waterloo, Ontario N2L 3G1, Canada

Alex Klein-Paste
Norwegian University of Science and Technology
Høyiskoleringen 7a
7491 Trondheim, Norway
+47-97-95-43-71; Fax: +47-73-59-70-21
E-mail: kleinpas@ntnu.no

Paul G. Knight
Pennsylvania State University
University Park, Pennsylvania

Freddy Knudsen
Danish Road Directorate
+45-7-2-443-425
E-mail: fek@vd.dk
www.vd.dk

Scott Koefod
Cargill, Incorporated
2301 Crosby Road
Wayzata, Minnesota 55391
952-742-5670; Fax: 952-742-5639
E-mail: scott_koefod@cargill.com

Scott S. Kroeber
University of North Dakota
4124 University Avenue
Grand Forks, North Dakota 58202-9007
701-777-2479; Fax: 701-777-3888
E-mail: scottk@rwic.und.edu

Dennis A. Kroeger
Center for Transportation Research and Education
Iowa State University
2711 South Loop Drive, Suite 4700
Ames, Iowa 50010-8664
515-294-8103; 515-294-0467
E-mail: kroeger@iastate.edu

Robert Glenn Lannert
Retired
Missouri Department of Transportation

Sung Lee
Federal Railroad Administration
U.S. Department of Transportation
RDV-31, Mail Stop 20
1120 Vermont Avenue, NW
Washington, D.C. 20590
202-493-6384; Fax: 202-493-6333
E-mail: mahmood.fateh@fra.dot.gov

Jean Livet
Centre d'Etudes Techniques de l'Équipement de l'Est
Laboratoire Régional des Ponts et Chaussées Nancy
ERA 31
71 Rue de la Grande Haie
54510 Tomblaine, France
+33-0-3-83-18-31-60; Fax: +33-0-3-83-18-41-41

Kai Rune Lysbakken
Norwegian University of Science and Technology
Trondheim, Norway
+47-91-36-90-72
E-mail: kai-rune.lysbakken@vegvesen.no

Bernie MacDonald
Nova Scotia Transportation and Public Works

William P. Mahoney III
National Center for Atmospheric Research
3450 Mitchell Lane
Boulder, Colorado 80301
303-497-8426; Fax: 303-497-8401
E-mail: mahoney@ucar.edu

Mario Marchetti
Centre d'Etudes Techniques de l'Équipement
(CETE) de l'Est Laboratoire Régional des Ponts
et Chaussées Nancy
ERA 31, 71 Rue de la Grande Haie
54510 Tomblaine, France
+33-0-3-83-18-31-60; Fax: +33-0-3-83-18-41-41
E-mail: mario.marchetti@equipement.gouv.fr

Yasuaki Matsuda
Civil Engineering Research Institute for Cold Region
Public Works Research Institute
1-3 Hiragishi Toyohira-ku
Sapporo, Hokkaido, 062-8602, Japan
+81-11-841-1746; Fax: +81-11-841-9747
E-mail: y-matsuda@ceri.go.jp

Tetsuro Matsushima
Civil Engineering Research Institute for Cold Region
Public Works Research Institute
1-3 Hiragishi Toyohira-ku
Sapporo, Hokkaido, 062-8602, Japan
+81-11-841-1746; Fax: +81-11-841-9747

Yuma Matsuyama
Civil Engineering Research Institute for Cold Region
Public Works Research Institute
1-3 Hiragishi Toyohira-ku
Sapporo, Hokkaido, 062-8602, Japan
+81-11-841-1746 ; Fax: +81-11-841-9747
E-mail: yu-matsuyama@ceri.go.jp

Masaru Matsuzawa
Civil Engineering Research Institute for Cold Region
Public Works Research Institute
1-3 Hiragishi Toyohira-ku
Sapporo, Hokkaido, 062-8602, Japan
+81-11-841-1746 ; Fax: +81-11-841-9747
E-mail: masaru@ceri.go.jp

Thomas H. Maze
Center for Transportation Research and Education
Iowa State University
2711 South Loop Drive, Suite 4700
Ames, Iowa 50010
515-294-8103; 515-294-0467
E-mail: tmaze@iastate.edu

Steve McArdle
4DM, Inc.
671 Danforth Avenue, Suite 305
Toronto, Ontario M4J 1L3, Canada

John McClintock
AMEC Earth and Environmental

John McHenry
Baron Advanced Meteorological Systems

Juan C. Medina
University of Illinois at Urbana-Champaign
B106 Newmark Civil Engineering Laboratory
MC-250
205 North Mathews Avenue
Urbana, Illinois 61801
217-333-5967
E-mail: jcmedina@uiuc.edu

John J. Mewes
Meridian Environmental Technology, Inc.
4324 University Avenue, Suite B
Grand Forks, North Dakota 58203
701-792-1800; Fax: 701-792-1831
E-mail: jmewes@meridian-enviro.com

Samuel Miller
Plymouth State University
17 Highland Street
Plymouth, New Hampshire 03264
E-mail: stmiller@plymouth.edu

Brian Mills
Meteorological Service of Canada,
Environment Canada
c/o Faculty of Environmental Studies
University of Waterloo
Waterloo, Ontario N2L 3G1, Canada
519-888-4567, Ext. 5496; Fax: 519-746-2031
E-mail: brian.mills@ec.gc.ca

Tatsuo Miyoshi
Civil Engineering Research Institute for Cold Region,
Public Works Research Institute
1-3 Hiragishi Toyohira-ku
Sapporo, Hokkaido, 062-8602, Japan
+81-11-841-1746; Fax: +81-11-841-9747
E-mail: miyoshi@ceri.go.jp

Greg Moffatt
AMEC Earth and Environmental

Staffan Möller
Swedish National Road and Transport
Research Institute
SE- 581 95
Linköping, Sweden
+46-0-13-20-41-61; Fax: +46-0-13-14-14-36
E-mail: staffan.moller@vti.se

William L. Myers
National Center for Atmospheric Research
3450 Mitchell Lane
Boulder, Colorado 80301

Yasuhiro Nagata
Japan Weather Association
North-4, West-23, Chuo-ku
Sapporo, Hokkaido, 064-8555, Japan
+81-11-622-2237 ; Fax: +81-11-622-8398
E-mail: naga@sapporo.jwa.or.jp

Shigeyuki Nakamae
National Highway and Risk Management Division,
Road Bureau
Ministry of Land, Infrastructure and Transport
+81-3-5253-8111; Fax: +81-3-5253-1620
E-mail: nakamae-s29n@mlit.go.jp

Aleksey Naumov
4DM, Inc.
671 Danforth Avenue, Suite 305
Toronto, Ontario M4J 1L3, Canada

Larry E. Nelson
Minnesota Department of Transportation
1900 West County Road I
Shoreview, Minnesota 55126
651-366-5248
E-mail: Larry.Nelson@dot.state.mn.us

Takashi Nishida
Subaru Technical Research Center, Fuji Heavy
Industries Ltd.
1-1 Subaru-cho, Ota,
Gunma, 373-8555, Japan
+81-276-26-2381; Fax: +81-276-26-3524
E-mail: nishida@gkh.subaru-fhi.co.jp

Wilfrid A. Nixon
University of Iowa
College of Engineering
4121 Seamans Center
Iowa City, Iowa 52242
319-335-5166; 319-335-5660
E-mail: wilfrid-nixon@uiowa.edu

Harald Norem
Norwegian University of Science and Technology,
Trondheim, Norway
+47-73-59-75-36
E-mail: Harald.norem@ntntu.no

Emmanuel U. Nzewi
North Carolina A&T State University
444 McNair Hall
Greensboro, North Carolina 27411
336-334-7737
E-mail: nzewi@ncat.edu

Takahiro Okawado
Hokkaido Development Engineering Center
+81-11-271-3022; Fax: +81-11-271-5366
E-mail: t-okawado@decnnet.or.jp

Don Olerud
Baron Advanced Meteorological Systems

Massiel A. Orellana
Iowa State University
Ames, Iowa

Leon F. Osborne, Jr.
Meridian Environmental Technology, Inc.
4324 University Avenue, Suite B
Grand Forks, North Dakota 58203
701-792-1800; Fax: 701-792-1831
E-mail: leono@meridian-enviro.com
University of North Dakota
4124 University Avenue
Grand Forks, North Dakota 58202-9007
701-777-249; Fax: 701-777-3888
E-mail: leono@rwic.und.edu

Junichi Oshima
Snow Research Center
+81-3-6740-2941; Fax: +81-3-6740-2942
E-mail: junichi@yukicenter.or.jp

Philippe Pecquenard
Station d'Essais de Matériels Routiers
31 Rue Laplace, CS 2912
41029 Blois, France
+33-0-2-54-55-49-60; Fax : +33-0-2-54-55-49-60
E-mail: philippe.pecquenard@equipement.gouv.fr

Max S. Perchanok
Ontario Ministry of Transportation
301 St. Paul Street, 2nd Floor South
St. Catharines, Ontario L2R 7R4, Canada
416-235-4680; 416-235-4020
E-mail: Max.Perchanok@ontario.ca

Curt M. Peterson
West Virginia University
P.O. Box 6216,
Morgantown, West Virginia 26506
304-293-3449; Fax: 304-293-7498
E-mail: Curt.Peterson@mail.wvu.edu

Kevin R. Petty
National Center for Atmospheric Research
3450 Mitchell Lane
Boulder, Colorado 80301
303-497-2705; Fax: 303-497-8401
E-mail: kpetty@ucar.edu

Paul A. Pisano
Federal Highway Administration
HOTO-1
1200 New Jersey Avenue, SE
Washington, D.C. 20590
202-366-1301; 202-366-3225
E-mail: paul.pisano@dot.gov

Paul Richard
Nova Scotia Transportation and Public Works

David Robbins
AMEC Earth and Environmental

Robert Sayer
AMEC Earth and Environmental

Xianming Shi
Western Transportation Institute
Montana State University
P.O. Box 174250
Bozeman, Montana 59717-4250
406-994-6486 ; Fax: 406-994-1697
E-mail: Xianming_s@coe.montana.edu

Åge Sivertsen
Norwegian Public Roads Administration
N-7030 Trondheim, Norway
+47-7-3-954-630; Fax: +47-2-2-073-768
E-mail: age.sivertsen@vegvesen.no

James T. Smith
University of Waterloo
Waterloo, Ontario N2L 3G1, Canada
519-888-4567, Ext. 3872; Fax: 519-888-6197
E-mail: jtsmith@engmail.uwaterloo.ca

Bo Sommer
Danish Road Directorate
+45-7-2-443-433
E-mail: fek@vd.dk
www.vd.dk

Andrew D. Stern
Noblis, Inc.
Oceans and Atmosphere Mission Area
3150 Fairview Park Drive South
Mailstop F530
Falls Church, Virginia 22042
703-610-1754; Fax: 703-610-1563
E-mail: astern@noblis.org

Christopher K. Strong
Western Transportation Institute
Montana State University
P.O. Box 174250
Bozeman, Montana 59717-4250
406-994-7351; 406-994-1697
E-mail: chriss@coe.montana.edu

Naoto Takahashi
Civil Engineering Research Institute for Cold Region
1-3 Hiragishi, Toyohira-ku
Sapporo, 062-8602, Japan
+81-11-841-1738; Fax: +81-11-841-9747
E-mail: takahashi-n24k@ceri.go.jp

Shin-ei Takano
Hokkaido University
+81-11-706-6205
E-mail: shey@eng.hokudai.ac.jp

Susan L. Tighe
University of Waterloo
Waterloo, Ontario N2L 3G1, Canada
519-888-4567, Ext. 3152; Fax: 519-888-6197
E-mail: sltighe@uwaterloo.ca

Jeffrey S. Tilley
University of North Dakota
3980 Campus Road, Stop 9007
Grand Forks, North Dakota 58202-9007
701-777-2479; 701-777-4898; Fax: 701-777-3888
E-mail: tilley@rwc.und.edu

Roberto A. Tokunaga
Civil Engineering Research Institute for Cold Region
1-3 Hiragishi, Toyohira-ku
Sapporo, 062-8602, Japan
+81-11-841-1738; Fax: +81-11-841-9747
E-mail: roberto-1097ga@ceri.go.jp

Nicole A. Trahan
University of Colorado
Boulder, Colorado 80309-0334
303-827-6868; Fax: 303-492-8699
E-mail: Nicole.Trahan@colorado.edu

Torgeir Vaa
SINTEF Roads and Transport
Klaebuveien 153
N-7465 Trondheim, Norway
+47-7-3-594-673; Fax: +47-7-3-594-623
E-mail: torgeir.vaa@sintef.no

Melissa Grace Wellman
Hometown Forecast Services
1 Chestnut Street
Nashua, New Hampshire 03060
603-882-3082; Fax: 603-459-0317
www.hometownforecastservice.com
E-mail: mwellman@hometownforecastservice.com

Philip Woodhams
AMEC Earth and Environmental

Joseph Zabransky
Retired Professor of Meteorology
17 Highland Street
Plymouth, New Hampshire 03264

Yu-Jiang Zhang
ENSCO, Inc.
5400 Port Royal Road
Springfield, Virginia 22151
703-321-4506; Fax: 703-321-7619
E-mail: zhang.yu-jiang@ensco.com

THE NATIONAL ACADEMIES

Advisers to the Nation on Science, Engineering, and Medicine

The **National Academy of Sciences** is a private, nonprofit, self-perpetuating society of distinguished scholars engaged in scientific and engineering research, dedicated to the furtherance of science and technology and to their use for the general welfare. On the authority of the charter granted to it by the Congress in 1863, the Academy has a mandate that requires it to advise the federal government on scientific and technical matters. Dr. Ralph J. Cicerone is president of the National Academy of Sciences.

The **National Academy of Engineering** was established in 1964, under the charter of the National Academy of Sciences, as a parallel organization of outstanding engineers. It is autonomous in its administration and in the selection of its members, sharing with the National Academy of Sciences the responsibility for advising the federal government. The National Academy of Engineering also sponsors engineering programs aimed at meeting national needs, encourages education and research, and recognizes the superior achievements of engineers. Dr. Charles M. Vest is president of the National Academy of Engineering.

The **Institute of Medicine** was established in 1970 by the National Academy of Sciences to secure the services of eminent members of appropriate professions in the examination of policy matters pertaining to the health of the public. The Institute acts under the responsibility given to the National Academy of Sciences by its congressional charter to be an adviser to the federal government and, on its own initiative, to identify issues of medical care, research, and education. Dr. Harvey V. Fineberg is president of the Institute of Medicine.

The **National Research Council** was organized by the National Academy of Sciences in 1916 to associate the broad community of science and technology with the Academy's purposes of furthering knowledge and advising the federal government. Functioning in accordance with general policies determined by the Academy, the Council has become the principal operating agency of both the National Academy of Sciences and the National Academy of Engineering in providing services to the government, the public, and the scientific and engineering communities. The Council is administered jointly by both the Academies and the Institute of Medicine. Dr. Ralph J. Cicerone and Dr. Charles M. Vest are chair and vice chair, respectively, of the National Research Council.

The **Transportation Research Board** is one of six major divisions of the National Research Council. The mission of the Transportation Research Board is to provide leadership in transportation innovation and progress through research and information exchange, conducted within a setting that is objective, interdisciplinary, and multimodal. The Board's varied activities annually engage about 7,000 engineers, scientists, and other transportation researchers and practitioners from the public and private sectors and academia, all of whom contribute their expertise in the public interest. The program is supported by state transportation departments, federal agencies including the component administrations of the U.S. Department of Transportation, and other organizations and individuals interested in the development of transportation. www.TRB.org

www.national-academies.org



TRANSPORTATION RESEARCH BOARD
500 Fifth Street, NW
Washington, DC 20001

THE NATIONAL ACADEMIES™

Advisers to the Nation on Science, Engineering, and Medicine

The nation turns to the National Academies—National Academy of Sciences, National Academy of Engineering, Institute of Medicine, and National Research Council—for independent, objective advice on issues that affect people's lives worldwide.

www.national-academies.org